

SHARP[®]

PN-V602A

LCD MONITOR

OPERATION MANUAL

HDMI

IMPORTANT:

To aid reporting in case of loss or theft, please record the product's model and serial numbers in the space provided. The numbers are located in the rear of the product.

Model No.:

Serial No.:

U.S.A. ONLY

FOR CUSTOMERS IN U.K.

IMPORTANT

The wires in this mains lead are coloured in accordance with the following code:

GREEN-AND-YELLOW:	Earth
BLUE:	Neutral
BROWN:	Live

As the colours of the wires in the mains lead of this apparatus may not correspond with the coloured markings identifying the terminals in your plug proceed as follows:



- The wire which is coloured GREEN-AND-YELLOW must be connected to the terminal in the plug which is marked by the letter **E** or by the safety earth \perp or coloured green or green-and-yellow.
- The wire which is coloured BLUE must be connected to the terminal which is marked with the letter **N** or coloured black.
- The wire which is coloured BROWN must be connected to the terminal which is marked with the letter **L** or coloured red.

Ensure that your equipment is connected correctly. If you are in any doubt consult a qualified electrician.

“WARNING: THIS APPARATUS MUST BE EARTHED.”

IMPORTANT INFORMATION

WARNING: TO REDUCE THE RISK OF FIRE OR ELECTRIC SHOCK, DO NOT EXPOSE THIS PRODUCT TO RAIN OR MOISTURE.

	CAUTION RISK OF ELECTRIC SHOCK DO NOT OPEN	
CAUTION: TO REDUCE THE RISK OF ELECTRIC SHOCK, DO NOT REMOVE COVER. NO USER-SERVICEABLE PARTS INSIDE. REFER SERVICING TO QUALIFIED SERVICE PERSONNEL.		



The lightning flash with arrowhead symbol, within an equilateral triangle, is intended to alert the user to the presence of uninsulated “dangerous voltage” within the product’s enclosure that may be of sufficient magnitude to constitute a risk of electric shock to persons.



The exclamation point within a triangle is intended to alert the user to the presence of important operating and maintenance (servicing) instructions in the literature accompanying the product.

WARNING:

FCC Regulations state that any unauthorized changes or modifications to this equipment not expressly approved by the manufacturer could void the user’s authority to operate this equipment.

NOTE:

This equipment has been tested and found to comply with the limits for Class A digital device, pursuant to Part 15 of the FCC Rules. These limits are designed to provide reasonable protection against harmful interference when the equipment is operated in a commercial environment. This equipment generates, uses, and can radiate radio frequency energy and, if not installed and used in accordance with the instruction manual, may cause harmful interference to radio communications. Operation of this equipment in a residential area is likely to cause harmful interference in which case the user will be required to correct the interference at his own expense.

This product utilizes a CR coin Lithium battery which contains a Perchlorate material. Special handling for this material may apply, California residents, See www.dtsc.ca.gov/hazardouswaste/perchlorate/ Others, consult local environmental officers.

U.S.A. ONLY

IMPORTANT INFORMATION (Continued)



Information on the Disposal of this Equipment and its Batteries

IF YOU WISH TO DISPOSE OF THIS EQUIPMENT OR ITS BATTERIES, DO NOT USE THE ORDINARY WASTE BIN, AND DO NOT PUT THEM INTO A FIREPLACE!

Used electrical and electronic equipment and batteries should always be collected and treated SEPARATELY in accordance with local law.

Separate collection promotes an environment-friendly treatment, recycling of materials, and minimizing final disposal of waste. IMPROPER DISPOSAL can be harmful to human health and the environment due to certain substances! Take USED EQUIPMENT to a local, usually municipal, collection facility, where available.

Remove USED BATTERIES from equipment, and take them to a battery collection facility; usually a place where new batteries are sold.

If in doubt about disposal, contact your local authorities or dealer and ask for the correct method of disposal.

ONLY FOR USERS IN THE EUROPEAN UNION, AND SOME OTHER COUNTRIES; FOR INSTANCE NORWAY AND SWITZERLAND: Your participation in separate collection is requested by law.

The symbol shown above appears on electrical and electronic equipment and batteries (or the packaging) to remind users of this. If 'Hg' or 'Pb' appears below the symbol, this means that the battery contains traces of mercury (Hg) or lead (Pb), respectively.

Users from PRIVATE HOUSEHOLDS are requested to use existing return facilities for used equipment and batteries.

Batteries are collected at points of sale. Return is free of charge.

If the equipment has been used for BUSINESS PURPOSES, please contact your SHARP dealer who will inform you about take-back. You might be charged for the costs arising from take-back. Small equipment (and small quantities) might be taken back by your local collection facility. For Spain: Please contact the established collection system or your local authority for take-back of your used products.

DEAR SHARP CUSTOMER

Thank you for your purchase of a SHARP LCD product. To ensure safety and many years of trouble-free operation of your product, please read the Safety Precautions carefully before using this product.

SAFETY PRECAUTIONS

Electricity is used to perform many useful functions, but it can also cause personal injuries and property damage if improperly handled. This product has been engineered and manufactured with the highest priority on safety. However, improper use can result in electric shock and/or fire. In order to prevent potential danger, please observe the following instructions when installing, operating and cleaning the product. To ensure your safety and prolong the service life of your LCD product, please read the following precautions carefully before using the product.

1. Read instructions — All operating instructions must be read and understood before the product is operated.
2. Keep this manual in a safe place — These safety and operating instructions must be kept in a safe place for future reference.
3. Observe warnings — All warnings on the product and in the instructions must be observed closely.
4. Follow instructions — All operating instructions must be followed.
5. Cleaning — Unplug the power cord from the AC outlet before cleaning the product. Use a dry cloth to clean the product. Do not use liquid cleaners or aerosol cleaners.
6. Attachments — Do not use attachments not recommended by the manufacturer. Use of inadequate attachments can result in accidents.
7. Water and moisture — Do not use the product near water. Do not install the product in a place where water may splash onto it. Be careful of equipment which drains water such as an air-conditioner.
8. Ventilation — The vents and other openings in the cabinet are designed for ventilation. Do not cover or block these vents and openings since insufficient ventilation can cause overheating and/or shorten the life of the product. Do not place the product on a sofa, rug or other similar surface, since they can block ventilation openings. Do not place the product in an enclosed place such as a bookcase or rack, unless proper ventilation is provided or the manufacturer's instructions are followed.
9. Power cord protection — The power cords must be routed properly to prevent people from stepping on them or objects from resting on them.
10. The LCD panel used in this product is made of glass. Therefore, it can break when the product is dropped or applied with impact. Be careful not to be injured by broken glass pieces in case the LCD panel breaks.
11. Overloading — Do not overload AC outlets or extension cords. Overloading can cause fire or electric shock.
12. Entering of objects and liquids — Never insert an object into the product through vents or openings. High voltage flows in the product, and inserting an object can cause electric shock and/or short internal parts. For the same reason, do not spill water or liquid on the product.
13. Servicing — Do not attempt to service the product yourself. Removing covers can expose you to high voltage and other dangerous conditions. Request a qualified service person to perform servicing.
14. Repair — If any of the following conditions occurs, unplug the power cord from the AC outlet, and request a qualified service person to perform repairs.
 - a. When the power cord or plug is damaged.
 - b. When a liquid was spilled on the product or when objects have fallen into the product.
 - c. When the product has been exposed to rain or water.
 - d. When the product does not operate properly as described in the operating instructions.

Do not touch the controls other than those described in the operating instructions. Improper adjustment of controls not described in the instructions can cause damage, which often requires extensive adjustment work by a qualified technician.
 - e. When the product has been dropped or damaged.
 - f. When the product displays an abnormal condition. Any noticeable abnormality in the product indicates that the product needs servicing.
15. Replacement parts — In case the product needs replacement parts, make sure that the service person uses replacement parts specified by the manufacturer, or those with the same characteristics and performance as the original parts. Use of unauthorized parts can result in fire, electric shock and/or other danger.
16. Safety checks — Upon completion of service or repair work, request the service technician to perform safety checks to ensure that the product is in proper operating condition.
17. Wall mounting — When mounting the product on a wall, be sure to install the product according to the method recommended by the manufacturer.
18. Heat sources — Keep the product away from heat sources such as radiators, heaters, stoves and other heat-generating products (including amplifiers).

SAFETY PRECAUTIONS (Continued)

19. Batteries — Incorrect use of batteries may cause the batteries to burst or ignite. A leaky battery may corrode the equipment, dirty your hands or spoil your clothing. In order to avoid these problems, make sure to observe the precautions below:
 - Use the specified batteries only.
 - Install the batteries with due attention to the plus (+) and minus (-) sides of the batteries according to the instructions in the compartment.
 - Do not mix old and new batteries.
 - Do not mix batteries of different types. Voltage specifications of batteries of the same shape may vary.
 - Replace an exhausted battery with a new one promptly.
 - If you will not use the remote control for a long time, remove the batteries.
 - If leaked battery fluid gets on your skin or clothing, rinse immediately and thoroughly. If it gets into your eye, bathe your eye well rather than rubbing and seek medical treatment immediately. Leaked battery fluid that gets into your eye or your clothing may cause a skin irritation or damage your eye.
20. Usage of the monitor must not be accompanied by fatal risks or dangers that, could lead directly to death, personal injury, severe physical damage or other loss, including nuclear reaction control in nuclear facility, medical life support system, and missile launch control in a weapon system.
21. Do not stay in contact with the parts of the product that become hot for long periods of time. Doing so may result in low-temperature burns.
22. Do not modify this product.

WARNING:

This is a Class A product. In a domestic environment this product may cause radio interference in which case the user may be required to take adequate measures.

To maintain compliance with EMC regulations, use shielded cables to connect to the following terminals: PC/AV DVI-D output terminal, PC/AV DVI-D input terminal, PC/AV HDMI input terminal, PC D-SUB input terminal, PC RGB input terminals, and RS-232C input/output terminals.

If a monitor is not positioned in a sufficiently stable location, it can be potentially hazardous due to falling. Many injuries, particularly to children, can be avoided by taking simple precautions such as:

- Using fixing devices like wall mount brackets recommended by the manufacturer.
- Only using furniture that can safely support the monitor.
- Ensuring the monitor is not overhanging the edge of the supporting furniture.
- Not placing the monitor on tall furniture (for example, cupboards or bookcases) without anchoring both the furniture and the monitor to a suitable support.
- Not standing the monitors on cloth or other materials placed between the monitor and supporting furniture.
- Educating children about the dangers of climbing on furniture to reach the monitor or its controls.
- This equipment is not suitable for use in locations where children are likely to be present unsupervised.

Especially for child safety

- Don't allow children to climb on or play with the monitor.
- Don't place the monitor on furniture that can easily be used as steps, such as a chest of drawers.
- Remember that children can become excited while watching a program, especially on a "larger than life" monitor. Care should be taken to place or install the monitor where it cannot be pushed, pulled over, or knocked down.
- Care should be taken to route all cords and cables connected to the monitor so that they cannot be pulled or grabbed by curious children.

TIPS AND SAFETY INSTRUCTIONS

- The TFT color LCD panel used in this monitor is made with the application of high precision technology. However, there may be minute points on the screen where pixels never light or are permanently lit. Also, if the screen is viewed from an acute angle there may be uneven colors or brightness. Please note that these are not malfunctions but common phenomena of LCDs and will not affect the performance of the monitor.
- Do not display a still picture for a long period, as this could cause a residual image.
- Never rub or tap the monitor with hard objects.
- Please understand that SHARP CORPORATION bears no responsibility for errors made during use by the customer or a third party, nor for any other malfunctions or damage to this product arising during use, except where indemnity liability is recognized under law.
- This monitor and its accessories may be upgraded without advance notice.
- Do not use the monitor where there is a lot of dust, where humidity is high, or where the monitor may come into contact with oil or steam. Do not use in an environment where there are corrosive gases (sulfur dioxide, hydrogen sulfide, nitrogen dioxide, chlorine, ammonia, ozone, etc.). As this could lead to fire.
- Ensure that the monitor does not come into contact with water or other fluids. Ensure that no objects such as paper clips or pins enter the monitor as this could lead to fire or electric shock.
- Do not place the monitor on top of unstable objects or in unsafe places. Do not allow the monitor to receive strong shocks or to strongly vibrate. Causing the monitor to fall or topple over may damage it.
- Do not use the monitor near heating equipment or in places where there is likelihood of high temperature, as this may lead to generation of excessive heat and outbreak of fire.
- Do not use the monitor in places where it may be exposed to direct sunlight. Risk of cabinet deformation and failure if the monitor is used in direct sunlight.
- If the monitor is installed in a location exposed to sunlight such as next to a window, measures to reduce ultraviolet and infrared radiation and temperature measures are required. For details, consult your dealer.
- Please be sure to constantly remove dust and garbage that has attached to the ventilation opening. If dust collects in the ventilation opening, it may lead to excessive heat, outbreak of fire, or malfunction. As a standard, clean the inside of the monitor once every year. If dust collects inside the monitor, it may lead to excessive heat, outbreak of fire, or malfunction. Please request a cleaning of the inside of the monitor from an authorized SHARP servicing dealer or service center.
- Images cannot be rotated on this monitor. When using in vertical orientation, you will need to prepare appropriately orientated content in advance.
- The AC outlet shall be installed near the equipment and shall be easily accessible.

The Power Cord

- Use only the power cord supplied with the monitor.
- Do not damage the power cord nor place heavy objects on it, stretch it or over bend it. Also, do not add extension cords. Damage to the cord may result in fire or electric shock.

- Do not use the power cord with a power tap. Adding an extension cord may lead to fire as a result of overheating.
- Do not remove or insert the power plug with wet hands. Doing so could result in electric shock.
- Unplug the power cord if it is not used for a long time.
- Do not attempt to repair the power cord if it is broken or malfunctioning. Refer the servicing to the service representative.

Manual Scope

- Microsoft, Windows and Internet Explorer are either registered trademarks or trademarks of Microsoft Corporation in the United States and/or other countries.
- The terms HDMI and HDMI High-Definition Multimedia Interface, and the HDMI Logo are trademarks or registered trademarks of HDMI Licensing Administrator, Inc. in the United States and other countries.
- Adobe, Acrobat, and Reader are either registered trademarks or trademarks of Adobe Systems Incorporated in the United States and/or other countries.
- This product comes with RICOH Bitmap Fonts produced and sold by RICOH COMPANY, LTD.
- All other brand and product names are trademarks or registered trademarks of their respective holders.
- Language of OSD menu used in this manual is English by way of example.
- Illustrations in this manual may not exactly represent the actual product or display.
- This manual assumes use in landscape orientation, except where specifically noted.
- This manual assumes that this product will be used with the remote control unit buttons, except where specifically noted. Operation by using the buttons on the rear side of the product will perform the same functions.

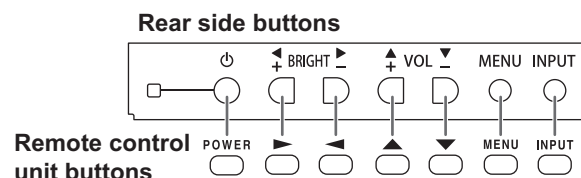

- * For operation with the remote control unit, the PN-ZR01 control kit (optional) is required.

LED Backlight

- The LED backlight in this product has a limited lifetime.
 - * If the screen gets dark or does not turn on, it may be necessary to replace the LED backlight. This LED backlight is exclusive to this product and must be replaced by an authorized Sharp servicing dealer or service center.
 - * Please contact your local Sharp servicing dealer or service center for assistance.

Fan

- The fan in this product has a limited lifetime.

MOUNTING PRECAUTIONS

- This product is for use indoors.
- A mounting bracket compliant with VESA specifications is required.
- Since the monitor is heavy, consult your dealer before installing, removing or moving the monitor.
- Mounting the monitor on the wall requires special expertise and the work must be performed by an authorized SHARP dealer. You should never attempt to perform any of this work yourself. Our company will bear no responsibility for accidents or injuries caused by improper mounting or mishandling.
- Use the monitor perpendicular to a level surface. If necessary, the monitor may be tilted up to 20 degrees upward or downward.
- When mounting the monitor horizontally, the optional fan cover (PN-ZR31) is required. For details along with the horizontal mounting conditions, consult your dealer.
- This monitor should be used at an ambient temperature between 32°F (0°C) and 104°F (40°C).
- Be careful of high temperatures in the surrounding area. When installing the monitor inside a housing, or if the ambient temperature may be outside of the range of 32°F (0°C) to 104°F (40°C), install a fan or take other measures to keep the ambient temperature within the required range.
- Temperature condition may change when using the monitor together with the optional equipments recommended by SHARP. In such cases, please check the temperature condition specified by the optional equipments.
- Do not block any ventilation openings. If the temperature inside the monitor rises, this could lead to a malfunction.
- Do not place the monitor on a device which generates heat.
- Adhere to the following when installing the monitor in its portrait orientation. Failing to adhere to the following may cause malfunctions.
 - To install in landscape orientation, rotate the monitor 90 degrees to the right.
 - Set the MONITOR on the SETUP menu to PORTRAIT. (See page 24.)
 - Be sure to secure the power cord (supplied) to the cable clamp attachment with the supplied cable clamp. Make sure that the power cord (supplied) does not supply power to the terminal when being secured and do not over bend the power cord (supplied).

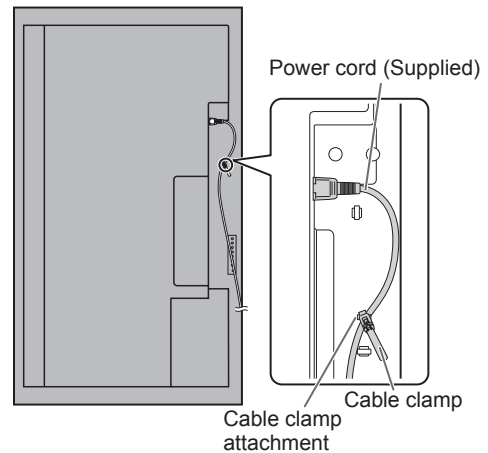

- A video wall should be only be composed of identical models. Do not use this monitor as part of a video wall that includes another model.

Mounting Precautions (For SHARP dealers and service engineers)

- When installing, removing or moving the monitor, ensure that this is carried out by at least 2 people.
- Be sure to use a wall-mount bracket designed or designated for mounting the monitor.
- This monitor is designed to be installed on a concrete wall or pillar. Reinforced work might be necessary for some materials such as plaster / thin plastic board / wood before starting installation. This monitor and bracket must be installed on a wall which can endure at least 4 times or more the weight of the monitor. Install by the most suitable method for the material and the structure.
- To attach a VESA-compliant mounting bracket, use M6 screws that are 5/16 inch (8 mm) to 3/8 inch (10 mm) longer than the thickness of the mounting bracket.

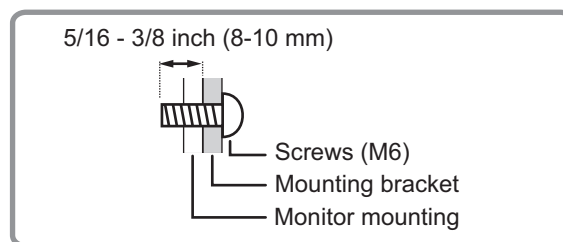

- When moving the monitor, be sure to hold it with either handles or the corners on the bottom of the unit. Do not hold the LCD panel. This may cause product damage, failure, or injury.
- When performing an installation where the monitor is stacked, please install it such that load is not placed on the monitor frame.
- After mounting, please carefully ensure the monitor is secure, and not able to come loose from the wall or mount.
- Do not use any screw holes other than VESA holes for installation.

Contents

IMPORTANT INFORMATION	3	Remote Control Mode	21
DEAR SHARP CUSTOMER	5	Menu Items	22
SAFETY PRECAUTIONS	5	Displaying the menu screen.....	22
TIPS AND SAFETY INSTRUCTIONS	7	Menu item details	23
MOUNTING PRECAUTIONS	8	Adjustments for PC screen display	30
Mounting Precautions (For SHARP dealers and		Initialization (Reset)/Functional Restriction Setting	
service engineers)	8	(FUNCTION)	31
Supplied Components	9	Controlling the Monitor with a PC (RS-232C)	32
Part Names	10	PC connection.....	32
Connecting Peripheral Equipment	12	Communication conditions	32
Multiple monitor connection	13	Communication procedure	32
Preparing the Remote Control Unit	15	Setting of the GAMMA user data.....	36
Installing the batteries	15	RS-232C command table.....	37
Remote control operation range.....	15	Controlling the Monitor with a PC (LAN)	45
Connecting the Power Cord	15	Settings to connect to a LAN.....	45
Binding Cables	16	Controlling with a PC.....	47
Removing the Handles	16	Troubleshooting	53
Affixing the Protection Covers	16	Specifications	55
Turning Power On/Off	17		
Turning on the main power.....	17		
Turning power on/off	17		
Disabling power on/off operations	17		
Basic Operation	18		

Supplied Components

If any component should be missing, please contact your dealer.

- | | |
|---|---|
| <input type="checkbox"/> Liquid Crystal Display Monitor: 1 | <input type="checkbox"/> Protection cover: 4 |
| <input type="checkbox"/> Cable clamp: 2 | <input type="checkbox"/> Handle screw (short): 4 |
| <input type="checkbox"/> Power cord | <input type="checkbox"/> Bezel sheet (long/short): 2 each |
| <input type="checkbox"/> CD-ROM (Utility Disk for Windows): 1 | <input type="checkbox"/> Bezel sheet attachment instructions: 1 |
| <input type="checkbox"/> Setup manual: 1 | |

* Sharp Corporation holds authorship rights to the Utility Disk program. Do not reproduce it without permission.

* For environmental protection!

Do not dispose of batteries in household waste. Follow the disposal instructions for your area.

Part Names

■ Front view

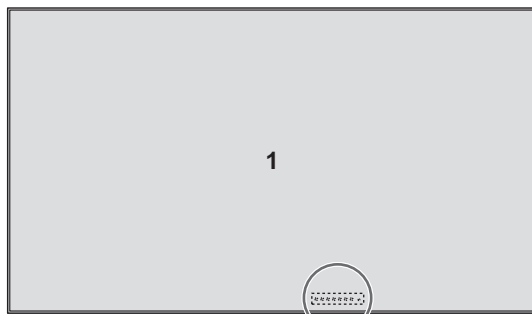

The rear buttons if seen from the front

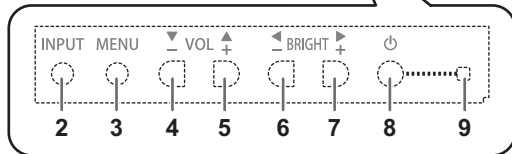

1. LCD panel
2. INPUT button
3. MENU button
4. VOL -/Cursor control (▼) button
5. VOL +/Cursor control (▲) button
6. BRIGHT -/Cursor control (▶) button
7. BRIGHT +/Cursor control (◀) button
8. Power button
9. Power LED

■ Rear view

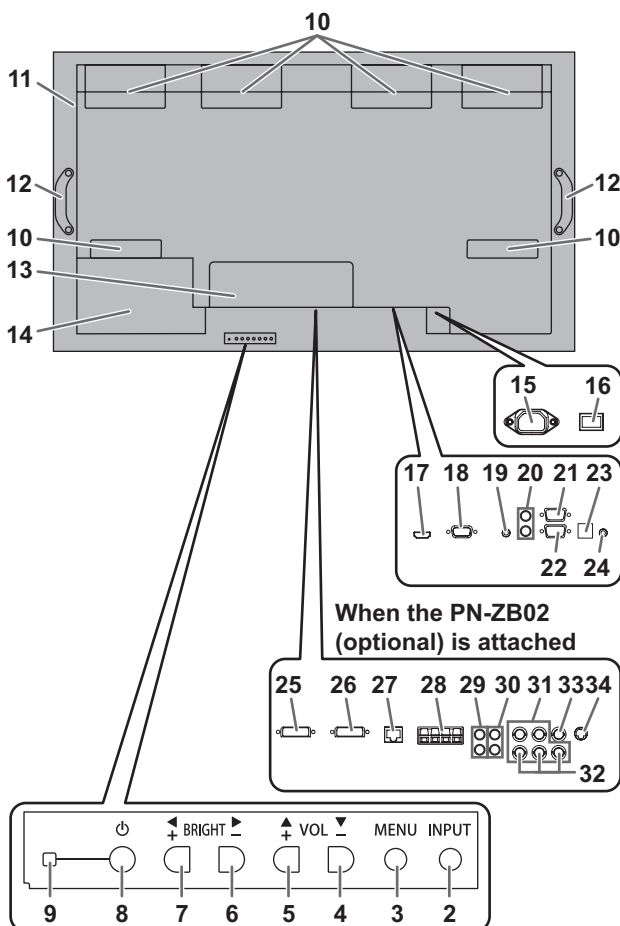

10. Fan/Fan cover
 11. Vents
 12. Handles
 13. Expansion terminal cover
Additional input/output terminals are available by attaching the PN-ZB02 interface expansion board (optional).
 14. Optional attachment section
This section is used to connect optional hardware for function expansion. Offering this attachment location is not a guarantee that future compatible hardware attachments will be released.
 15. AC input terminal
 16. Main power switch
 17. PC/AV HDMI input terminal
 18. PC D-sub input terminal
 19. Audio input terminal
 20. Audio output terminals
 21. RS-232C output terminal
 22. RS-232C input terminal
 23. Optional terminal
This terminal is provided for possible future (optional) function expansion. Offering of this terminal is not a guarantee that future expanded functionality will be provided.
 24. Control kit terminal
- When the PN-ZB02 (optional) is attached
25. PC/AV DVI-D input terminal
 26. PC/AV DVI-D output terminal
 27. LAN terminal
 28. External speaker terminals
 29. Audio 1 input terminals
 30. Audio 2 input terminals
 31. PC RGB input terminals
 32. AV component input terminals
 33. AV video input terminal
 34. AV S-video input terminal

! Caution

- Consult your SHARP dealer for attachment/detachment of optional parts.
- Do not block the fan cover.
- Do not open the expansion terminal cover by yourself. There are high voltage parts inside the cover which may cause an electric shock.

■ Remote control unit
(Supplied with the PN-ZR01 (optional))

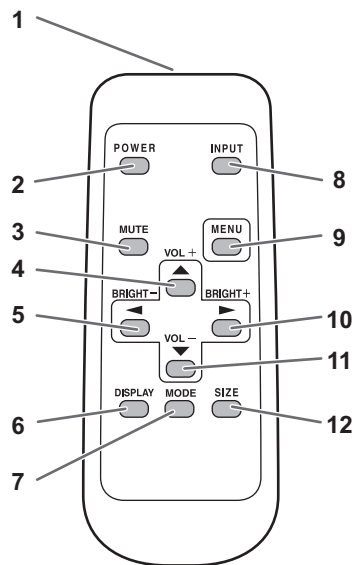

1. Signal transmitter
2. POWER button
3. MUTE button
4. VOL +/Cursor control (▲) button
5. BRIGHT -/Cursor control (◀) button
6. DISPLAY button
7. MODE button
8. INPUT button
9. MENU button
10. BRIGHT +/Cursor control (▶) button
11. VOL -/Cursor control (▼) button
12. SIZE button

■ Remote control sensor box
(Supplied with the PN-ZR01 (optional))

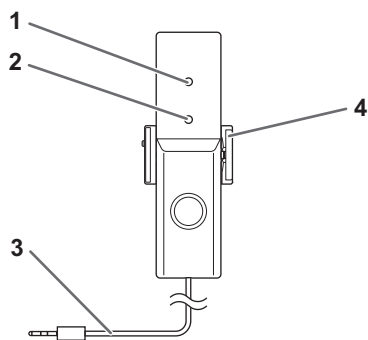

1. Brightness sensor
2. Remote control sensor
3. Connection cable
4. Mounting bracket

Connecting Peripheral Equipment

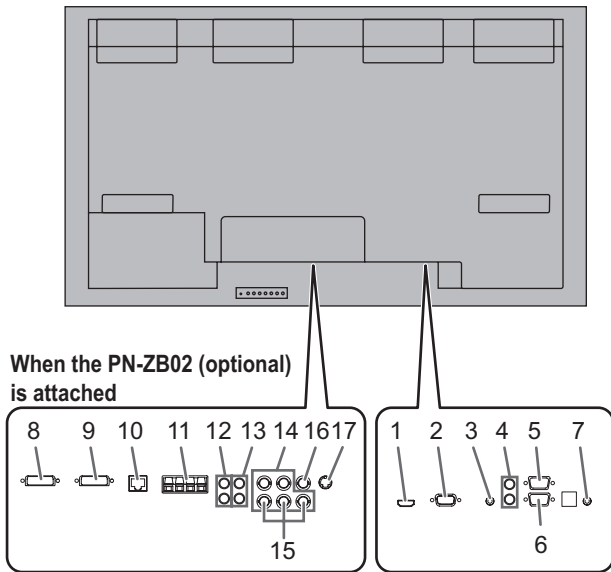

Caution

- Be sure to turn off the main power switch and disconnect the plug from the power outlet before connecting/disconnecting cables. Also, read the manual of the equipment to be connected.
- Be careful not to confuse the input terminal with the output terminal when connecting cables. Accidentally reversing cables connected to the input and output terminals may cause malfunctions and the other problems.
- Do not use any cable that has a damaged or deformed terminal. Using such cables may cause malfunctions.

TIPS

- Images may not be displayed properly depending on the computer (video card) to be connected.
- A screen with 1920 x 1080 resolution may not be displayed correctly on PC RGB. In this case, check the settings of your computer (video card) to verify that input signals conform to specifications of this monitor. (See page 57.)
- If there is a check box to disable EDID in display control panel, check it when using PC RGB.
- Use the automatic screen adjustment when a PC screen is displayed for the first time using PC D-SUB or PC RGB, or when the setting of the PC is changed. The screen is adjusted automatically when SELF ADJUST in the OPTION menu is set to ON.
- If the audio output from the playback device is connected directly to speakers or other devices, the video on the monitor may appear delayed from the audio portion. Audio should be played through this monitor by connecting the playback device to the monitor's audio input, and connecting the monitor's audio output to the speakers or other devices.
- The audio input terminals used in each input mode are factory-set as follows.

Input mode	Audio input terminal (Factory setting)
PC D-SUB, PC DVI-D, PC RGB	Audio input terminal
AV DVI-D	Audio1 input terminal
AV COMPONENT (BNC), AV S-VIDEO, AV VIDEO (BNC)	Audio2 input terminal
AV COMPONENT (D-SUB), AV VIDEO (D-SUB)	Audio input terminal
PC HDMI, AV HDMI	PC/AV HDMI input terminal

1. PC/AV HDMI input terminal

- Use a commercially available HDMI cable (conforming to the HDMI standard).
- Set HDMI of INPUT SELECT on the OPTION menu according to the device to be connected.
- Select the audio input terminal to be used in PC HDMI or AV HDMI of AUDIO SELECT on the OPTION menu. When HDMI is selected, connection to the audio input terminal is unnecessary.

2. PC D-sub input terminal

- Set D-SUB of INPUT SELECT on the OPTION menu according to the device to be connected.
- Common terminal for AV COMPONENT and AV VIDEO.
- When the PN-ZB02 (optional) is attached, select the audio input terminal to be used in PC D-SUB of AUDIO SELECT on the OPTION menu.
- To use with AV VIDEO (D-SUB), connect the green terminal to the device's video output.

3. Audio input terminal

- Use an audio cable without resistance.
- When the PN-ZB02 (optional) is attached, set the audio input terminal used for each input mode in AUDIO SELECT on the OPTION menu.

4. Audio output terminals

- The output sound varies depending on the input mode.
- The volume of the output sound can be fixed by setting AUDIO OUTPUT(RCA) on the OPTION menu.
- It is not possible to control the sound output from the audio output terminals with the AUDIO menu.

5. RS-232C output terminal

6. RS-232C input terminal

- You can control the monitor from a PC by connecting a commercially available RS-232 straight cable between these terminals and the PC.
- When using the PN-ZR01 control kit (optional) to perform operation of multiple monitors with the remote control unit, connect multiple monitors in a daisy chain using the commercially available RS-232 straight cable. (See page 14.)

7. Control kit terminal

- Connects the remote control sensor box of the PN-ZR01 control kit (optional). (See page 14.)

■ Connection when the PN-ZB02 (optional) is attached

The PN-ZB02 expansion board (optional) allows the use of additional connection terminals.

8. PC/AV DVI-D input terminal

- Set DVI of INPUT SELECT on the OPTION menu according to the device to be connected.
- Select the audio input terminal to be used in PC DVI-D or AV DVI-D of AUDIO SELECT on the OPTION menu.

9. PC/AV DVI-D output terminal

- The video of the PC/AV DVI-D input can be output to an external device.
- Outputting HDCP-encrypted video requires an external device which supports HDCP.
- This terminal allows the daisy chain connection of up to 5 monitors.

TIPS

- The length of the signal cables or surrounding environment may affect the image quality.
- The screen may not display properly when using terminals other than PC DVI-D/AV DVI-D for the input mode. In this case, turn off the power to all the monitors connected in a daisy chain and then turn the power on again.
- When connecting monitors in a daisy chain set AUTO INPUT CHANGE to OFF.
- Video output is disabled in the following cases:
When the power is turned off
When the monitor is in input signal waiting mode

10. LAN terminal

- You can control the monitor from a PC on a network by connecting a commercially available LAN cable between this terminal and a network.

11. External speaker terminals

- Be sure to use external speakers with an impedance of 6 Ω or greater and a rated input of at least 10 W.

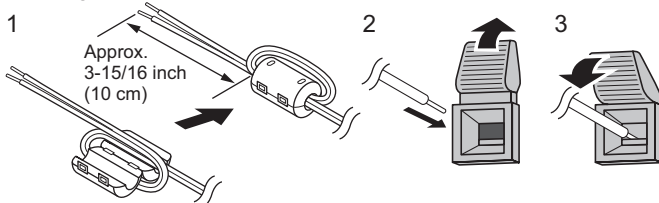

1. Attach a speaker cable core (included with the PN-ZB02) to the end of the speaker cable connected to the monitor.
2. While pushing the tab, insert the tip of the cable.
3. Release the tab.

TIPS

- Be sure to connect the + and - terminals and the left and right speakers properly.
- Avoid short circuiting the + and - terminals.

12. Audio1 input terminals

13. Audio2 input terminals

- Set the audio input terminal to be used in each input mode in AUDIO SELECT on the OPTION menu.

14. PC RGB input terminals

- Set BNC of INPUT SELECT on the OPTION menu to PC RGB when using the PC RGB input terminals.
- Select the audio input terminal to be used in PC RGB of AUDIO SELECT on the OPTION menu.

15. AV component input terminals

- Set BNC of INPUT SELECT on the OPTION menu to AV COMPONENT when using the AV component input terminals.
- Select the audio input terminal to be used in AV COMPONENT of AUDIO SELECT on the OPTION menu.
- Cannot be used when D-SUB in INPUT SELECT on the OPTION menu is set to AV COMPONENT.

16. AV video input terminal

- Select the audio input terminal to be used in AV VIDEO of AUDIO SELECT on the OPTION menu.
- Cannot be used when D-SUB in INPUT SELECT on the OPTION menu is set to AV VIDEO.

17. AV S-video input terminal

- Select the audio input terminal to be used in AV S-VIDEO of AUDIO SELECT on the OPTION menu.

Multiple monitor connection

The monitors can be aligned and used as a large screen.

[Example]

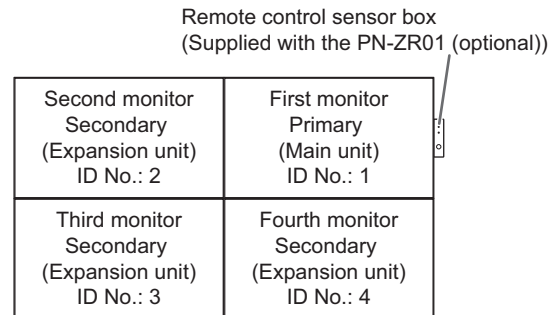

TIPS

- Connect the RS-232C cables in order, starting with the first monitor (primary monitor). If monitors are connected in a different order they may not be operable.
- Always install the remote control sensor box on the primary monitor.

■ Connection with video cable

May vary depending on the system being used.
If using the PC/AV DVI-D terminal, up to 5 monitors can be connected in a daisy chain. (When the PN-ZB02 is attached)

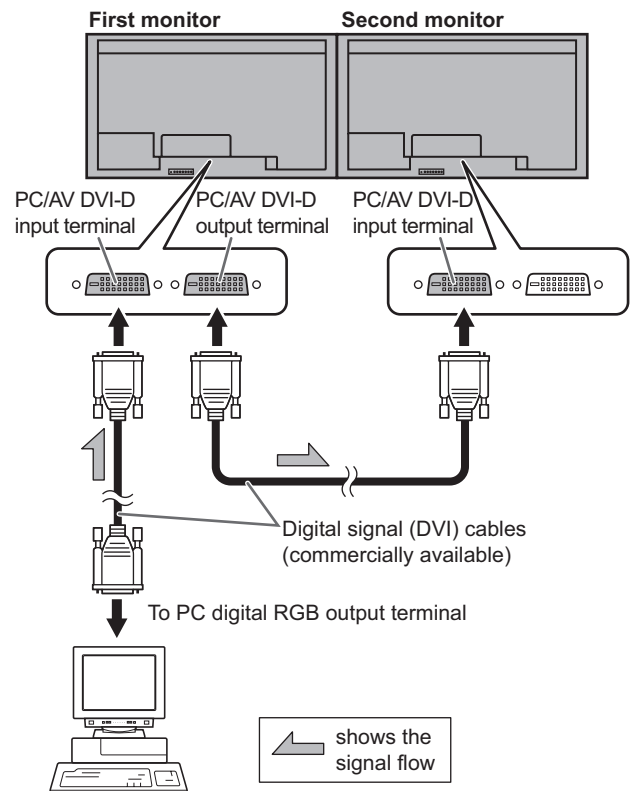

Connecting Peripheral Equipment

■ Connection with RS-232 cable

If you connect the monitor in a daisy chain using RS-232 cable, using the monitor buttons on the primary (main unit), settings are copied to the secondary (expansion unit) and operation from the primary can perform operation for all monitors. Setting each ID No. in the monitor is required.

1. Connect the monitors in order.

The first monitor will be set as primary (main unit) and the second monitor and beyond will be secondaries (expansion units).

Connect the RS-232C output terminal of the first monitor (primary) and the RS-232C input terminal of the second monitor (secondary) together using RS-232 cable (straight). Connect in the same way to the third and subsequent monitors. Up to 25 monitors can be connected. (Depending on the length of the cable used and the surrounding environment.)

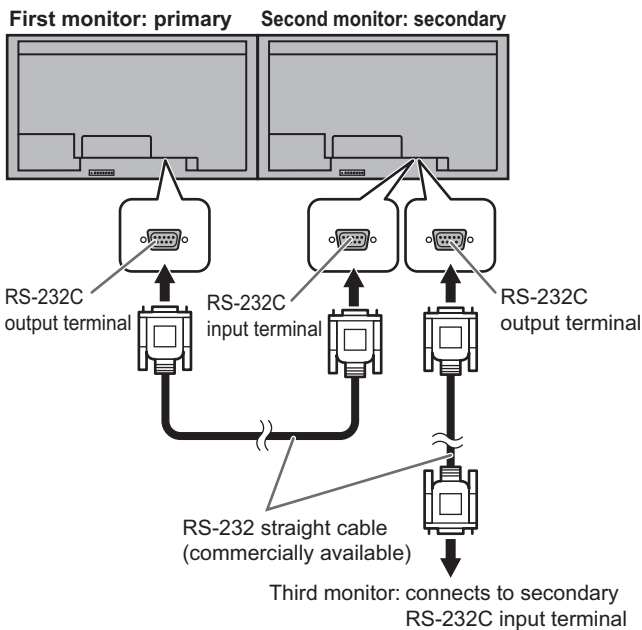

2. Set the ID No.

Perform operation with the rear side buttons on the primary monitor. If you set AUTO ASSIGN ID No., located in the menu of the monitor to ON, the ID No. will be automatically assigned in order from the primary. (See page 24.) (If you attach PN-ZR01 the control kit (optional), you can perform operation of the monitors with the remote control unit.)

■ Connection with the control kit (optional)

If performing operation of the monitor with the remote control unit, the PN-ZR01 control kit (optional) is required.

- Can perform operation of an arbitrary monitor or all monitors with the remote control unit of the first monitor.
- Can perform operation of up to 25 monitors.
- Connect the monitors together in a daisy chain with RS-232 cable.

Attach the remote control sensor box as shown in the following illustration.

* When attached to the left side, because the top and bottom for the remote control sensor box will be reversed (the connection cable will be on top), the right side is recommended.

! Caution

- When attaching the remote control sensor box, turn the main power switch OFF.
- Except for the remote control sensor box connection cable, do not insert any other cable into the control kit terminal. Also, do not connect any connection cables that have been extended with commercially available cables.

For the monitor in landscape orientation



For the monitor in portrait orientation

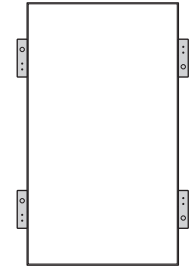

1. Insert the anti-rotation protrusion of the mounting bracket into the anti-rotation hole of the monitor.
2. Secure the stand angling hole of the monitor with the mounting screw.
3. Adjust the angle of the remote control sensor box, and secure it with the fixing screw, so that it may accurately receive signals from the remote control unit.

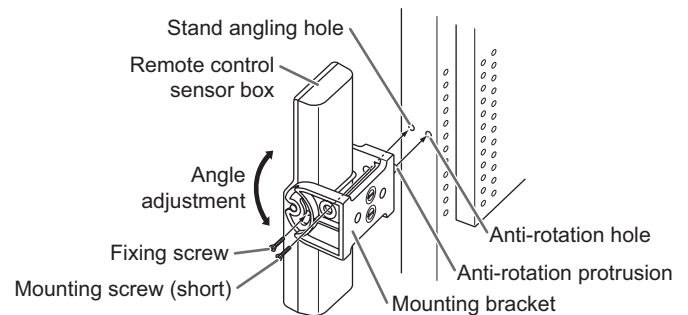

4. Insert the remote control sensor box connection cable into the control kit terminal.

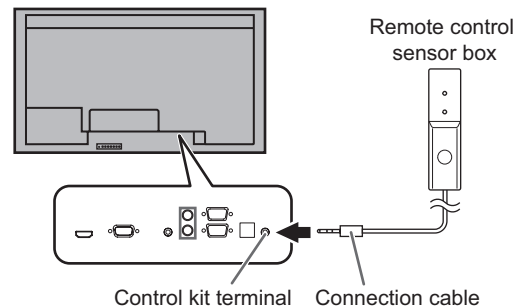

TIPS

- When you connect the remote control sensor box, the brightness sensor can be used. The screen brightness will automatically change according to lighting conditions and the surrounding brightness. (See page 25.)
- Depending on where it has been placed or the surrounding conditions, the remote control sensor box may be affected by the brightness of the main unit screen and the brightness sensor may respond.
- Do not install the remote control sensor box in extremely bright or dark areas. The brightness sensor may not function properly.

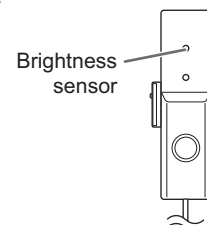

Preparing the Remote Control Unit

Installing the batteries

1. Press the cover gently and slide it in the direction of the arrow.

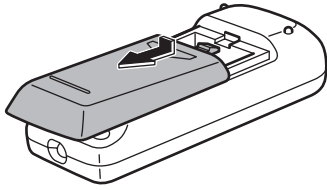

2. See the instructions in the compartment and put in the batteries (R-6 ("AA" size) x 2) (supplied with the PN-ZR01 (optional)) with their plus (+) and minus (-) sides oriented correctly.
3. Close the cover.

TIPS

- When the batteries become exhausted replace them with new (commercially available) batteries.
- The supplied batteries (R-6 ("AA" size) x 2) may become exhausted quickly depending on how they are stored.
- If you will not be using the remote control for a long time, remove the batteries.
- Use manganese or alkaline batteries only.

Remote control operation range

The operation range of the PN-ZR01 (optional) remote control unit is approx. 23 feet (7 m) when aimed directly at the remote control sensor box. When used at an angle of approx 10° from the center to the top/bottom/right/left of the remote control sensor, use it within a distance of approx 16.4 feet (5 m).

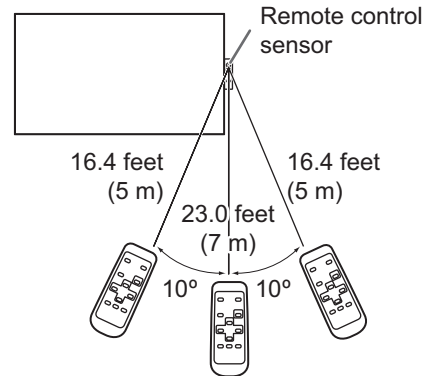

TIPS

- Do not expose the remote control unit to shock by dropping or stepping on it. This could lead to a malfunction.
- Do not expose the remote control unit to liquids, and do not place it in an area with high humidity.
- The remote control unit may not work properly if the remote control sensor is under direct sunlight or strong lighting.
- Objects between the remote control unit and the remote control sensor may prevent proper operation.
- Replace the batteries when they run low as this may shorten the remote control's operation range.
- If a fluorescent light is illuminated near the remote control unit, it may interfere with proper operation.
- Do not use it with the remote control of other equipment such as air conditioner, stereo components, etc.
- Adjust the angle of the PN-ZR01 (optional) remote control sensor and have it face the area where operation with the remote control unit will take place.

Connecting the Power Cord

! Caution

- Use only the power cord supplied with the monitor.

1. Turn off the main power switch.
2. Plug the power cord (supplied) into the AC input terminal.
3. Plug the power cord (supplied) into the AC power outlet.

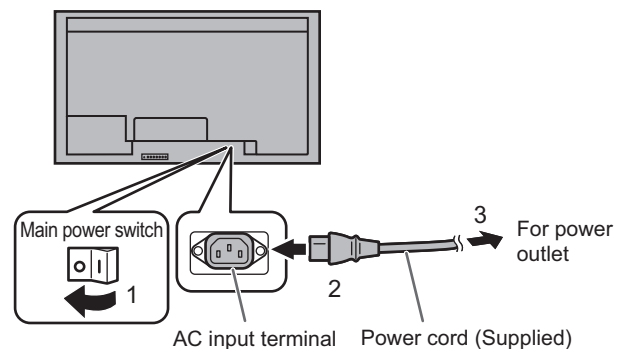

Binding Cables

The cables connected to the terminals on the rear of the monitor can be fastened with the cable clamps.

Insert the cable clamp into the cable clamp attachment on the rear of the monitor and fasten the cables.

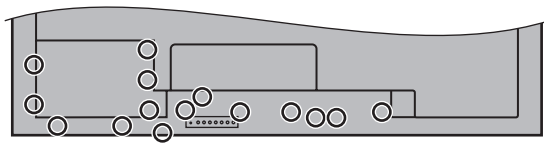

○ : Cable clamp attachment

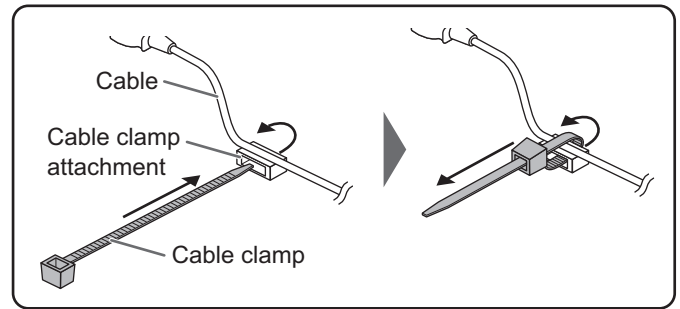

Removing the Handles

The handles can be removed.

The removed handles can be attached on the side.

1. Remove the handle screws and remove the handles and handle spacers.
2. Pass the handle screws through the handles and handle spacers in order and secure.

! Caution

- The handles, handle screws and handle spacers are for this monitor. Do not use them for any other devices.
- When attaching the handles, always use this monitor's handles, handle spacers, and handle screws.
- Be sure the handles are attached securely.

TIPS

- To lower the height of the handles, attach the handles with the handle spacers removed. To attach the handles with the handle spacers removed, secure the handles with the included handle screws (short).

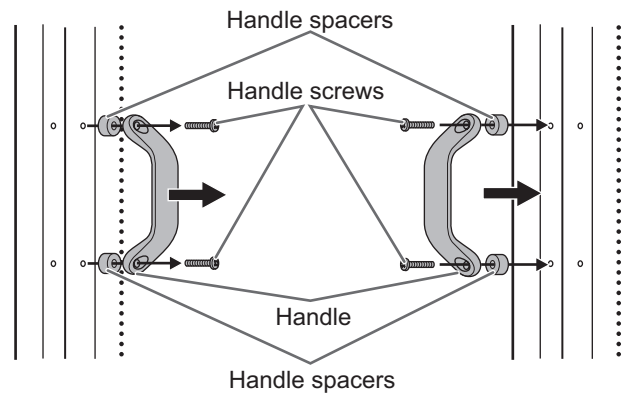

Affixing the Protection Covers

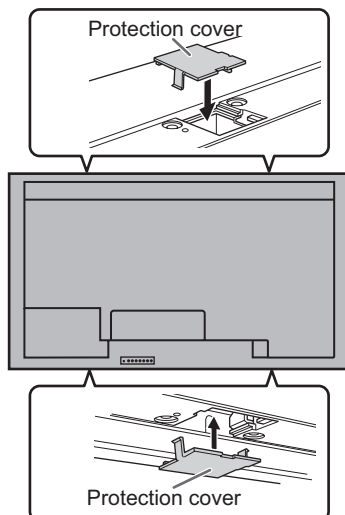

After installing the monitor, affix the protection covers (4 pieces) as necessary.

Turning Power On/Off

! Caution

- Turn on the monitor first before turning on the PC or playback device.
- When switching the main power switch or the POWER button off and back on, always wait for at least 5 seconds. A short interval may result in a malfunction.

Turning on the main power

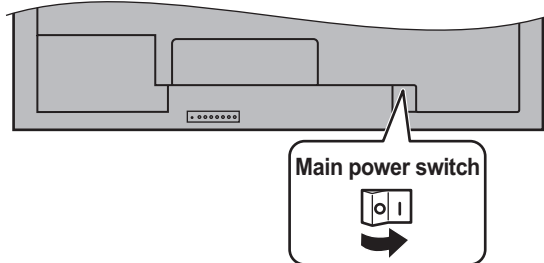

! Caution

- The main power must be turned on/off with the main power switch. Do not connect/disconnect the power cord or turn the breaker on/off while the main power switch is on.
- For a complete electrical disconnection, pull out the main plug.

Turning power on/off

Press the POWER button on the remote control unit or the monitor itself to turn the power ON/OFF.

When the main power switch is off, the monitor cannot be turned on using the POWER button on the remote control unit.

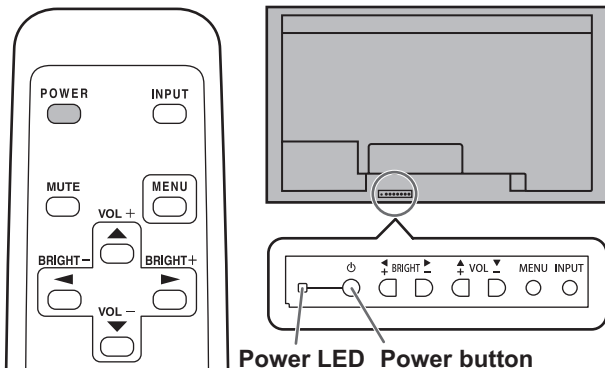

Status of a power LED	Status of the monitor
Green lighting	Power on
Orange lighting	Power off (Standby mode)
Green flashing	Input signal waiting mode

TIPS

- If the monitor is in the input signal standby mode and you press the POWER button on the remote control unit, the monitor enters standby mode.
- Setting the SCHEDULE flashes the power LED alternately in red and orange in standby mode.
- To disable the logo screen from displaying when turning the power ON, set LOGO SCREEN to OFF on the SETUP menu. (See page 25.)
- If you change the remote control mode to ALL MONITORS, power can be turned ON/OFF for all secondary monitors connected with RS-232 cable. (For operation with the monitor buttons, use the buttons on the primary monitor.)

■ Operation mode

When the monitor is turned on for the first time after being shipped from the factory, the operation mode setting screen will be displayed. Set it to MODE1 or MODE2.

MODE1...OFF IF NO OPERATION is set to ON, and STANDBY MODE is set to LOW POWER. (These settings can not be changed.)

If there is no operation for 4 hours or more, the monitor automatically enters standby mode. Power consumption in standby mode is also minimized.

MODE2...Will perform standard operation.

OFF IF NO OPERATION is set to OFF, and STANDBY MODE is set to STANDARD. These settings can be changed.

Even after being set, changes can be made using OPERATION MODE, located in the menu of the monitor. (See page 24.)

■ Date/time setting

- If the time has yet to be set when the monitor is first turned on, the date/time setting screen appears. Set the date and time.

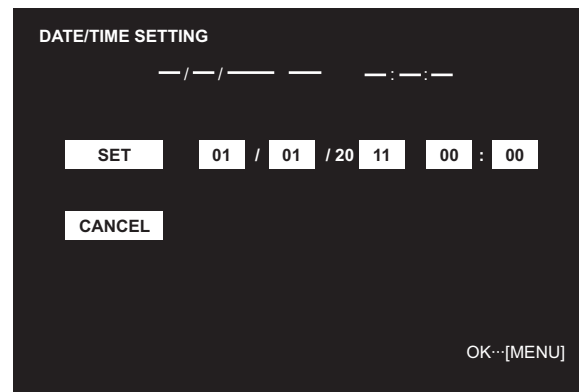

1. Press , , or to select the date and time, and press or to change the numerical values.
 2. Press or to select SET and then press .
- Be sure to set the date and time.
 - The date/time setting screen will close automatically if no operation is performed for about 15 seconds. The date and time can be set using DATE/TIME SETTING from the OPTION menu when the date/time setting screen disappears.

TIPS

- Set the date in "Day/Month/Year" order.
- Set the time on a 24-hour basis.
- The clock is maintained by the internal battery.
- If you already set the time but the date/time setting screen appears when the power is turned on, the internal battery may be exhausted. Please contact your local Sharp servicing dealer or service center for assistance with battery replacement.
- Estimated service life of the internal battery: About 5 years (depending on monitor operation)
- The initial battery was inserted at the factory when the monitor was shipped, so it may run out of power before its expected operation life.

Disabling power on/off operations

Power on/power off operations can be disabled in order to protect the monitor from an accidental power off. Set the ADJUSTMENT LOCK in FUNCTION menu to "ON 2". (See page 31.)

Basic Operation

When performing operation of multiple monitors with the remote control unit, first set the remote control unit to the appropriate remote control mode (see page 21).

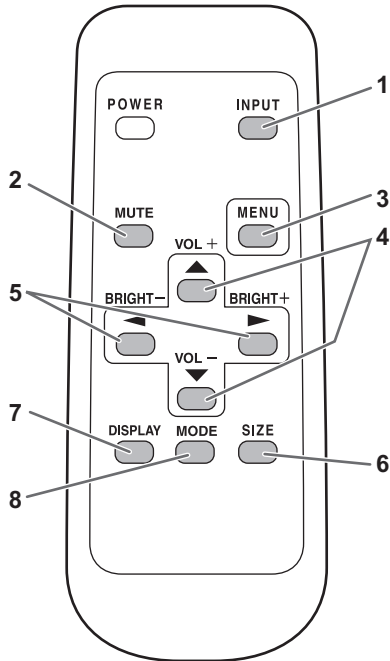

TIPS

- You can perform operation of the monitor with the rear buttons. Utilize the buttons belonging to the monitor that you would like to operate.
- Operation by using the buttons on the rear side of the product will perform the same functions.

Rear side buttons

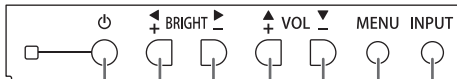

Remote control unit buttons



This manual assumes that this product will be used with the remote control unit buttons, except where specifically noted.

1. INPUT (Input mode selection)

The menu is displayed. Press or to select the input mode, and press to enter.

Input mode	Video	Audio
PC D-SUB	PC D-sub input terminal*1	Audio input terminal
PC HDMI	PC/AV HDMI input terminal*2	*3
AV HDMI	PC/AV HDMI input terminal*2	
AV COMPONENT	PC D-sub input terminal*1	Audio input terminal
AV VIDEO	PC D-sub input terminal*1	

When the PN-ZB02 (optional) is attached

Input mode	Video	Audio
PC DVI-D	PC/AV DVI-D input terminal*4	*3
PC HDMI	PC/AV HDMI input terminal*2	
PC D-SUB	PC D-sub input terminal*1	
PC RGB	PC RGB input terminals*5	
AV DVI-D	PC/AV DVI-D input terminal*4	
AV HDMI	PC/AV HDMI input terminal*2	
AV COMPONENT	AV COMPONENT input terminals*5 PC D-sub input terminal*1	
AV S-VIDEO	AV S-video input terminal	
AV VIDEO	AV video input terminal PC D-sub input terminal*1	

*1 Select the terminal to be used in D-SUB of INPUT SELECT. (See page 26.)

*2 Select the terminal to be used in HDMI of INPUT SELECT. (See page 26.)

*3 Select the terminal for AUDIO SELECT which is used for audio input. (See page 26.)

*4 Select the terminal to be used in DVI of INPUT SELECT. (See page 26.)

*5 Select the terminal to be used in BNC of INPUT SELECT. (See page 26.)

2. MUTE

Turns off the volume temporarily.

Press the MUTE button again to turn the sound back to the previous level.

If using the monitor buttons, either hold both and at the same time or select MUTE AUDIO from the OPTION menu.

3. MENU

Displays and turns off the menu screen (see page 22).

4. VOL +/- (Volume adjustment)

Pressing or displays the VOLUME menu when the menu screen is not displayed.



Press or to adjust the volume of the sound.

* If you do not press any buttons for about 4 seconds, the VOLUME menu automatically disappears.

5. BRIGHT +/- (Backlight adjustment)

Pressing ◀ or ▶ displays the BRIGHT menu when the menu screen is not displayed.



Press ◀ or ▶ to adjust the brightness.

- * If you do not press any buttons for about 4 seconds, the BRIGHT menu automatically disappears.
- * When BRIGHTNESS SENSOR is ON or ON: DISPLAY, when the brightness is adjusted BRIGHTNESS SENSOR will become OFF.

6. SIZE (Screen size selection)

The menu is displayed.

Press ◀ or ▶ to select the screen size. (See page 20.)
If using the monitor buttons, select SIZE from the OPTION menu.

7. DISPLAY

Displays monitor information. When you press this button again, the display disappears.

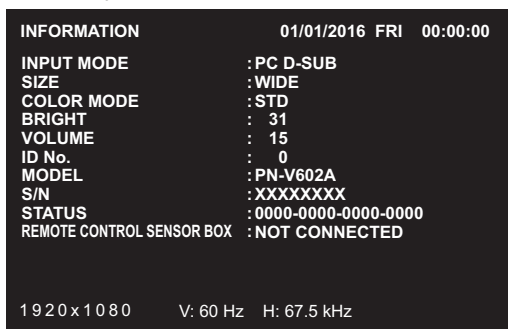

When the PN-ZB02 (optional) is attached, the display changes from INFORMATION1 → INFORMATION2 → clear display, and so on every time you press this button.

- The display disappears automatically after about 15 seconds.
- [LAN] is displayed during LAN communication.
- If [LAN] is displayed in red, there is a duplicate IP address.

If using the monitor buttons, press ◀ under INFORMATION in the OPTION menu.

8. MODE (Color mode selection)

Each time you press this button, the color mode changes in the following order:

```

STD (Standard) → VIVID → sRGB →
HIGH ILLUMINANCE → STD...
  
```

- HIGH ILLUMINANCE is a display with colors suited to bright locations.
- sRGB applies to PC input only.
sRGB is international standard of color representation specified by IEC (International Electrotechnical Commission). Color conversion is made in taking account of liquid crystal's characteristics and represents color tone close to its original image.

If using the monitor buttons, select COLOR MODE from the PICTURE menu.

Basic Operation

■Switching the screen size

Even when the screen size is changed, the display may remain the same depending on the input signal.

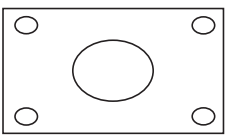
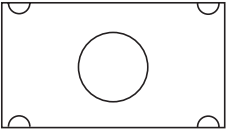
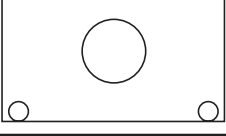
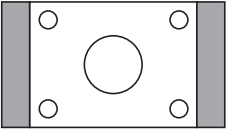
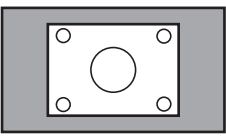
WIDE		PC input	Displays image so it fills the entire screen.
		AV input	An image with a 4:3 aspect ratio is stretched to fill the entire screen.
ZOOM 1		PC input	An image with a 4:3 aspect ratio is enlarged to fill the entire screen without changing the aspect ratio. The edges of the image may be cut off.
		AV input	
ZOOM 2		PC input	Use this size if ZOOM 1 cuts off the subtitles.
		AV input	
NORMAL		PC input	Displays image so it fills the screen without changing the aspect ratio of the input signals.
		AV input	Displays the entire image of the aspect ratio of 4:3 without changing the aspect ratio.
Dot by Dot		PC input	Displays the dots of the signals input from the connected PC as the corresponding dots on the screen.
		AV input	Displays the dots of the input signals as the corresponding dots on the screen.

TIPS

- Using this monitor's screen-size switching or dual-screen display functions to compress or expand the screen for commercial or public viewing in establishments like cafes or hotels may infringe on the rights of the creators, as protected by Copyright Law, so please be careful.
- When "Enlarge" is set, the screen size is fixed to "WIDE" mode.
- When dual-screen display is selected, the screen size cannot be changed.
- The appearance of the original video may change if you select a screen size with a different aspect ratio than the original image (e.g. TV broadcast or video input from external equipment).
- When an ordinary non-wide image (4:3) is viewed with the whole screen using the screen-size switching function of this monitor, the edge of the image may be lost or appear distorted. If you wish to respect the creator's intentions, set the screen size to "NORMAL".
- When playing commercial software, parts of the image (like subtitles) may be cropped. In this case select the optimal screen size using the screen-size switching function of this monitor. With some software, there may be noise or distortion at the edges of the screen. This is due to the characteristics of the software, and is not a malfunction.
- Depending on the original image size, black bands may remain at the edges of the screen.

Remote Control Mode

With the remote control unit it's possible to perform operation of...

- The primary monitor
- Monitors with a specified ID No.
- All primary/secondary monitors

It's necessary to specify which type of operation will be performed in advance.

1. If using the remote control unit, press **MODE** for approx 5 seconds.

If using the monitor buttons, hold both **MENU** and **↑** at the same time on the primary.

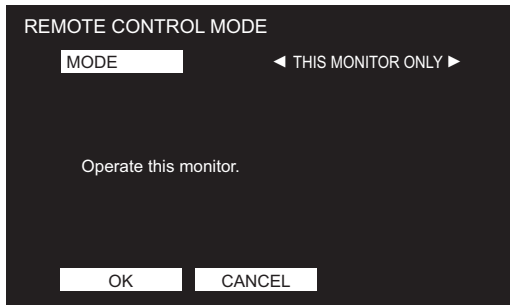

2. Press **←** or **→**, select the mode, then perform settings.

THIS MONITOR ONLY

Performs operation of only the primary using the remote control unit.

[Example] If the volume is lowered, the volume of the primary will lower.

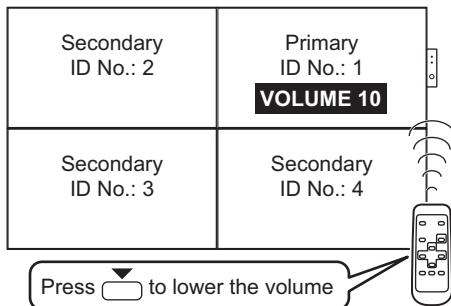

SPECIFIED MONITOR

Performs operation of a monitor with a specified ID No. using the remote control unit.

Press **←** or **→** to select ID No., then press **←** or **→** to select the ID No. of the monitor that you will operate.

* When it receives signals from the remote control unit, "Operating specified monitor." will be displayed on the primary screen.

[Example.] If ID No. is set to 3 and the volume is lowered, the volume of the monitor for ID No.: 3 will lower.

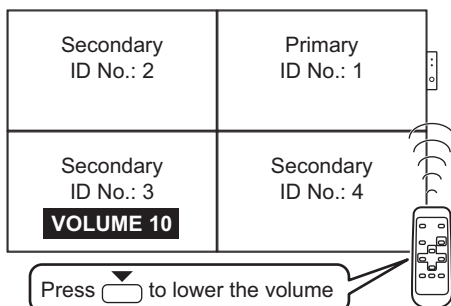

When you would like to confirm the ID No. that is set to the monitor, press **←** or **→** to select ID No. DISPLAY, then press **→**. The ID No. will be displayed on the screen.

ALL MONITORS

Performs operation of all primary/secondary monitors.

- * **ALL** will be displayed on the menu of the primary.
- * When it receives signals from the remote control unit, "Operating all monitors." will be displayed on the secondary screen. (Excluding power and input mode selection operation)
- * Settings may not be reflected depending on the state of the connected monitors.

[Example] If the power for the primary is turned ON, the power for all the monitors will be turned ON.

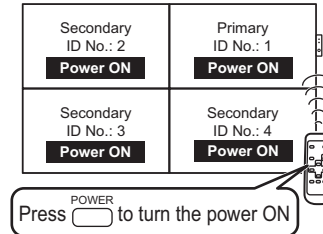

Press **↑** or **↓** to select EXPAND ITEM, and press **←** or **→** to select to perform this action or not.

OFF For all monitors, only power, input mode selection, and product information display operations will be recognized.

ON For all monitors, all operations will be recognized.

After returning to the normal screen with procedure 3, when 5 minutes have passed from the end of operation, it will automatically return to OFF.

ALL [EXPAND ITEM] will be displayed on the menu of the primary.

* Even when REMOTE CONTROL MODE is set to ALL MONITORS, certain settings such as LAN settings and ID No. settings will not be reflected on the other monitors.

3. Press **←** or **→** to select OK, then press **MENU** and return to the normal screen.

4. Perform operation.

Caution

- When the remote control mode is set to ALL MONITORS and EXPAND ITEM is set to ON, performing remote control operations that change adjustment values will result in the secondary adjustment values being the same as the primary adjustment values.

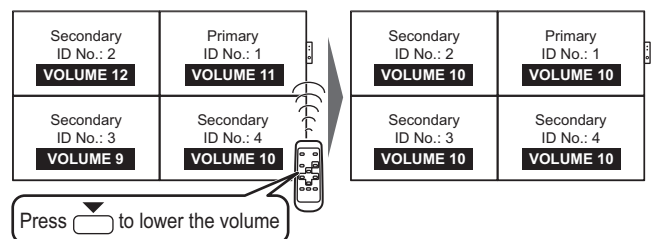

Be careful of this when adjusting individual displays.

TIPS

- You can copy the setting values of the primary to other monitors with COPY SETTING VALUE. (See page 25.)
- The buttons on the monitor itself (primary) are also effective in remote control mode.
- When monitors connected in a daisy chain are in standby mode for LOW POWER, operation cannot be performed for subsequent monitors.

Menu Items

Displaying the menu screen

Video and audio adjustment and settings of various functions are enabled. This section describes how to use the menu items. See pages 23 to 27 for details of each menu items.

Caution

- Do not turn the main power switch off while the menu items are being displayed. Doing so may initialize the settings.

Example of operation

(Adjusting CONTRAST in the PICTURE menu)

- Press to display the menu screen.

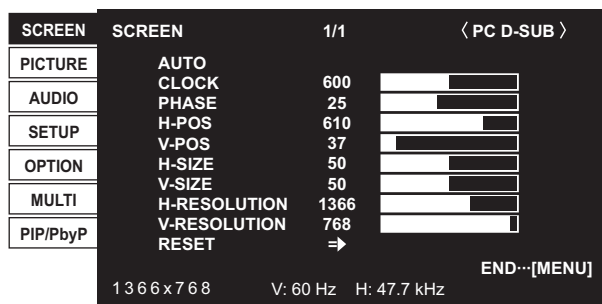

- Press or to select PICTURE, and press .

- Press or to select CONTRAST.

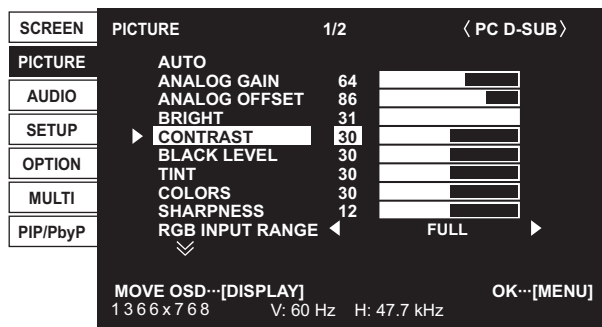

- Press or to adjust the setting.

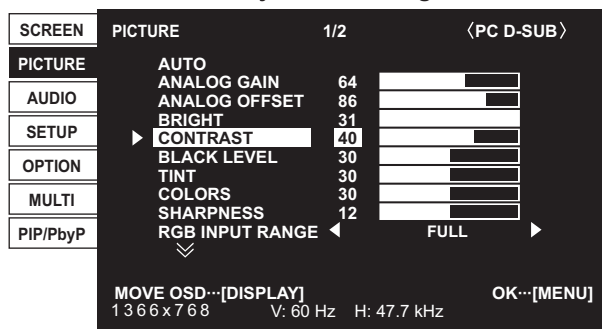

For items that have , press to make settings and then press .

- Press twice to close the menu screen.

TIPS

- The menu will differ depending on the input mode.
- The menu screen will close automatically if no operation is performed for about 15 seconds. (DATE/TIME SETTING, SCHEDULE and LAN SETUP screens will close in about 4 minutes.)

Menu screen display

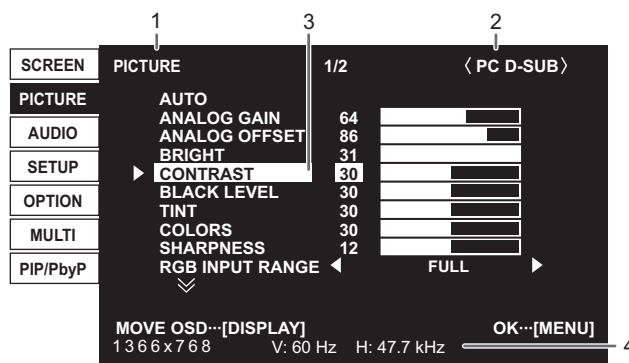

- Name of the menu
- Input mode
- An item being selected (highlighted)
- Screen resolution of input signal, and other data.

TIPS

- Items that cannot be selected appear in gray. (e.g. Function not supported by the current input signal)

Menu Items

The displayed menu items vary depending on whether or not the PN-ZB02 (optional) is attached.

The following menus will be displayed only when the PN-ZB02 (optional) is attached.

Menu	Item	
SETUP	HOT PLUG CONTROL	DVI
	RS-232C/LAN SELECT	
	LAN SETUP	
OPTION	INPUT SELECT	DVI BNC
	AUDIO SELECT	PC DVI-D
		PC D-SUB
		PC RGB
		AV DVI-D
		AV COMPONENT (BNC)
		AV COMPONENT (D-SUB)
	AV S-VIDEO	
	AV VIDEO (BNC)	
AV VIDEO (D-SUB)		
PIP/PbyP	PIP SOURCE	

Menu item details

The menu will differ depending on the input mode.

■SCREEN

You can move the menu screen display position each time  is pressed.

AUTO (PC D-SUB/PC RGB)

The CLOCK, PHASE, H-POS, and V-POS are automatically adjusted.

Pressing  performs adjustment.

Use this automatic adjustment when you use the PC D-sub input terminal or PC RGB input terminals to display a PC screen for the first time or when you change the setting of the PC. (See page 30.)

CLOCK (PC D-SUB/PC RGB)

Adjusts frequency for sampling clock for applicable video. Adjust when there is flickering in the form of vertical stripes. When using the adjustment pattern (see page 30), make adjustments so that no vertical stripe noise appears in it.

PHASE (PC D-SUB/PC RGB)

Adjusts sampling clock phase for applicable video.

Useful when small characters appear with low contrast and/or there are flickers at corners.

When using the adjustment pattern (see page 30), make adjustments so that no horizontal stripe noise appears in it.

* Adjustments to PHASE should be made only after CLOCK has been correctly set.

H-POS

Adjust the horizontal position of the image.

V-POS

Adjust the vertical position of the image.

H-SIZE

Adjust the horizontal size of the image.

V-SIZE

Adjust the vertical size of the image.

H-RESOLUTION (PC D-SUB/PC RGB)

Sets proper horizontal resolution when the resolution of input signals is not recognized properly. (Adjustment may be impossible with some signals.)

V-RESOLUTION (PC D-SUB/PC RGB)

Sets proper vertical resolution when the resolution of input signals is not recognized properly. (Adjustment may be impossible with some signals.)

RESET

Resets the values of the SCREEN menu items to the factory preset values.

Select ON and then press .

■PICTURE

You can move the menu screen display position each time  is pressed.

AUTO (PC D-SUB/PC RGB)

The ANALOG GAIN and ANALOG OFFSET are automatically adjusted.

Pressing  performs adjustment.

ANALOG GAIN (PC D-SUB/PC RGB)

Adjusts the bright portions of the video input signal.

ANALOG OFFSET (PC D-SUB/PC RGB)

Adjusts the dark portions of the video input signal.

BRIGHT

Adjusts the backlight brightness. (In PIP mode, the main side setting is reflected in the image.)

CONTRAST

Adjusts the difference between the bright and dark portions of the image.

BLACK LEVEL

Adjusts the entire brightness of the video signals.

TINT

Adjusts the hue. Selecting + changes the color towards green, and selecting - changes it towards magenta.

COLORS

Adjusts the color intensity.

SHARPNESS

Adjusts the sharpness of the image.

RGB INPUT RANGE (PC DVI-D/PC HDMI/PC D-SUB/PC RGB/AV DVI-D/AV HDMI)

Sets the RGB input signal range. When using HDMI set to AUTO, the RGB input signal is detected automatically. Use AUTO normally.

If the RGB input signal range cannot be set appropriately even when using AUTO, set according to the image. When the setting is different, images will be displayed with washed out blacks and compressed gradients.

ADVANCED (AV input)

You can adjust more specifically. (See page 30.)

COLOR MODE

Changes the color mode on the screen. The color mode on the screen can also be changed using a remote control unit. (See page 19.)

* sRGB is PC input only. See page 19 for details.

WHITE BALANCE

THRU..... Displays the input signal level as is. (for PC DVI-D/PC HDMI only)

PRESET Selects the color temperature using PRESET.

USER..... Used for adjusting R-/G-/B-CONTRAST and R-/G-/B-OFFSET respectively.

PRESET

Selects the color temperature when the WHITE BALANCE is set to PRESET.

The setting values are shown for reference. The color temperature of the screen varies over time.

This function is not intended to keep the color temperature constant.

Menu Items

USER

Adjusts each item when the WHITE BALANCE is set to USER.

- R-CONTRAST Adjusts bright-toned red component.
- G-CONTRAST Adjusts bright-toned green component.
- B-CONTRAST Adjusts bright-toned blue component.
- R-OFFSET Adjusts dark-toned red component.
- G-OFFSET Adjusts dark-toned green component.
- B-OFFSET Adjusts dark-toned blue component.

COPY TO USER

Copies the value set for PRESET to the USER setting. Select ON and then press .

GAMMA

Selects the gamma. USER sets the gamma to the sent value (see page 36). (In PIP mode, the main side setting is reflected in the image.)

When using LOCAL DIMMING, it controls the brightness per area. So, the gamma may differ from the set value.

LOCAL DIMMING

Automatically controls the backlight brightness per area according to the image. Increasing the level of this setting will result in higher contrast of the image, and will lower the monitor power consumption.

Light leakage and/or a ring-like appearance may be seen depending on the image. Change the setting in this situation. (In PIP mode, the main side setting is reflected in the image.) When using multiple monitors, if there is a difference in the brightness between the monitors, adjust the setting.

POWER LIMITED

Can be set when LOCAL DIMMING is HIGH. Set the value so that it is smaller than the set power consumption (see page 56.) by adjusting the brightness, etc.

DISPLAY COLOR PATTERN

Displays a color pattern. Can be displayed while the menu screen is displayed, so you can refer to the pattern while adjusting the image.

- OFF No pattern display.
- WHITE White single color pattern display.
- RED Red single color pattern display.
- GREEN Green single color pattern display.
- BLUE Blue single color pattern display.
- USER Red/green/blue mixed color pattern display.
When USER is selected, set each color's level.

RESET

Resets the values of the PICTURE menu items to the factory preset values.

Select ON and then press .

AUDIO

TREBLE

Adjusts the volume of treble-level sound.

BASS

Adjusts the volume of bass-level sound.

BALANCE

Adjusts the balance of the audio sound between right and left.

RESET

Resets the values of the AUDIO menu items to the factory preset values.

Select ON and then press .

SETUP

OSD H-POSITION

Adjusts the horizontal display position of menu screen.

OSD V-POSITION

Adjusts the vertical display position of menu screen.

MONITOR

Select the installation direction of the monitor.

- LANDSCAPE Landscape orientation
- PORTRAIT Portrait orientation

LANGUAGE

Sets the display language for the menu screen.

POWER ON DELAY

You can delay the screen display after the monitor is turned on. The period can be set up to 60 seconds in units of one second. When this function is activated, the power LED flashes (at approx. 1 second interval) in orange. This function is disabled when 0 is specified.

OPERATION MODE

- MODE1 OFF IF NO OPERATION is set to ON, and STANDBY MODE is set to LOW POWER. (These settings can not be changed.)
- MODE2 Will perform standard operation. OFF IF NO OPERATION is set to OFF, and STANDBY MODE is set to STANDARD. These settings can be changed.

STANDBY MODE

When STANDARD is selected, startup time from standby mode is reduced. Note, however that, more power will be consumed in standby mode.

When LOW POWER is selected, current consumption is reduced while the monitor is in standby mode. Note, however, that the startup time from standby mode becomes longer.

If set to LOW POWER, certain RS-232C commands cannot be used in standby mode, and control via LAN will be disabled.

OFF IF NO OPERATION

Determines whether or not to set the monitor to go into standby mode when there is no operation from the remote control unit, RS-232C commands, or LAN for over 4 hours.

HOT PLUG CONTROL

Sets whether to use hot plug control for the PC/AV HDMI and PC/AV DVI-D input terminals.

RS-232C/LAN SELECT

Selects the method with which to control the monitor from the computer.

ID No. SET

Assigns ID numbers to monitors connected in a daisy chain (see page 34), using the remote control unit or RS-232 cables.

The numbers 1 to 255 are available for ID numbers. If "0" is set, the system regards this as the state where no ID number is set.

AUTO ASSIGN ID No.

ID No. to be used will be automatically assigned when multiple monitors are connected with RS-232C.

Select ON, then press . Perform operations with the primary monitor.

BAUD RATE

Selects the communication speed used for RS-232C communication.

LAN SETUP

Configures the settings to control the monitor from the computer via LAN. (See page 45.)

AUTO ASSIGN FIXED IP ADDR.

Can be enabled when RS-232C/LAN SELECT is LAN and the DHCP CLIENT is OFF.

Set the DHCP CLIENT for secondary monitors connected by RS-232C to OFF and a fixed IP address is automatically allocated.

If the IP address is a duplicate with a network device other than a monitor, individually change the IP address.

OPTION DC OUT SETTING

Normally, leave this setting as OFF.

When using an optional part, if instruction appears, change the setting accordingly.

HDMI AUTO VIEW

When ON is selected, the screen size is adjusted automatically according to the screen size control signal included in the video signal input from the AV HDMI input terminal.

BRIGHTNESS SENSOR

(When connected to the PN-ZR01 (optional) only)

When set to ON or ON: DISPLAY, the brightness will automatically change according to the lighting and surrounding brightness. Performs operation with the primary monitor. If set to ON: DISPLAY, the effect will be displayed with a .

If connecting to multiple monitors, the brightness of all the monitors will change.

The  will be displayed on the primary only.

When setting BRIGHT in SCHEDULE on the OPTION menu, set BRIGHTNESS SENSOR to OFF.

BRIGHTNESS SENSOR SETTING

(When connected to the PN-ZR01 (optional) only)

Performs adjustments to the brightness sensor. Performs operation with the primary monitor.

Set the surrounding brightness and the current screen luminance to AMBIENT BRIGHTNESS and SCREEN BRIGHTNESS.

Individually set WHEN LIGHT: and WHEN DARK:.

Even if brighter or darker than the set AMBIENT BRIGHTNESS, the screen brightness will not change.

CURRENT AMBIENT BRIGHTNESS is shown for reference.

COPY SETTING VALUE

When the monitor has been connected to multiple monitors with RS-232C, you can copy the primary setting details to the secondary. Perform operations with the primary monitor. Selects the settings to copy with COPY SETTING VALUE TARGET.

“PICTURE” ONLY ... Copies the PICTURE menu settings.*

ALL Copies all the settings.*

Select the ID No. of the monitor that you would like copy to with COPY TO ID No., then select COPY and press .

If you select ALL, settings will be copied to all monitors.

When you would like to confirm the ID No. that is set to the monitor, select ID No. and press . The ID No. will be displayed on the screen.

* Certain setting details such as ANALOG GAIN, ANALOG OFFSET, and DISPLAY COLOR PATTERN cannot be copied.





LOGO SCREEN

Sets whether or not to display the logo screen.

Menu Items

■OPTION

DATE/TIME SETTING

Set the date and time. Press  or  to select the date and time, and press  or  to change the numerical values.

Set the date in "Day/Month/Year" order.

Set the time on a 24-hour basis. (Factory default)

DATE/TIME FORMAT

Sets the date/time display format.

DATEMM/DD/YYYY

DD/MM/YYYY

YYYY/MM/DD

(YYYY: Year, MM: Month, DD: Day)

TIMESelect 12- or 24-hour time.

SCHEDULE (See page 29.)

You can turn the power on/off and change the screen brightness at a specified time.

INPUT SELECT

Select the input mode to be used in PC D-Sub input terminal, PC/AV DVI-D input terminal, PC/AV HDMI input terminal and PC RGB/AV component input terminals.

For D-SUB, select SET after selecting the input mode, and then press .

D-SUB and BNC cannot be set to AV COMPONENT at the same time.

If D-SUB is set to AV VIDEO, the AV VIDEO input terminal cannot be used for BNC.

AUDIO SELECT

Selects the terminal used to input audio signals in each input mode.

INPUT SIGNAL (PC D-SUB/PC RGB)

If a computer connected to the PC D-sub/PC RGB input terminal outputs any of the following resolutions, make a selection from the following options.

480 LINESAUTO, 640x480 or 848x480

768 LINESAUTO, 1024x768, 1280x768, 1360x768 or 1366x768

1050 LINES1400x1050 or 1680x1050

ZOOM2 SPECIAL SETTING (See page 29.)

SCAN MODE (AV input)

Sets the scan mode used for AV mode input.

MODE1Over-scan display

MODE2Under-scan display

MODE3Under-scan display when the input signal is 1080i/p. Otherwise, over-scan display

* Even when MODE1 is selected, under-scan display is used when the input signal is 1080i/p and the screen size is Dot by Dot.

POWER MANAGEMENT

POWER MANAGEMENT determines whether or not to switch modes from no signal to the input signal standby mode.

COLOR SYSTEM (AV S-VIDEO/AV VIDEO)

Select the color system of the AV equipment which is connected to AV S-video and AV video input terminal. (AUTO / PAL / PAL-60 / SECAM / NTSC3.58 / NTSC4.43)

When AUTO is selected, the color system is automatically set according to the input signal.

AUDIO OUTPUT(RCA)

Sets the volume of sound output from the audio output terminals. When set to VARIABLE2, audio is not output from the external speaker terminals.

VARIABLE You can adjust the volume using VOLUME.

FIXED Disables volume adjustment and fixes the sounds.

When the PN-ZB02 (optional) is attached:

VARIABLE1 You can adjust the volume using VOLUME.

VARIABLE2 You can adjust the volume using VOLUME, but audio is not output from the external speaker terminals.

FIXED Disables volume adjustment and fixes the sounds.

AUDIO LEVEL(STEREO MINI)

Selects the maximum audio input level of the audio input terminal.

SELF ADJUST

On a PC D-SUB/PC RGB screen, specify whether to perform screen adjustment automatically or not. When ON is selected, the screen is automatically adjusted when its resolution is 800 x 600 or higher and the timing of input signals changes. "ADJUSTING" appears on the screen during the adjustment. For images with black edges, etc., depending on the signal, adjustment may not be possible. In this case select OFF. (Perform manual adjustment of the screen.)

AUTO INPUT CHANGE

Specify whether to change inputs automatically. When ON is selected and no signal is present in the selected input mode, AUTO INPUT CHANGE automatically changes the selected mode to another mode where a video signal is present.

When video signals exist in multiple input modes, the switching priority is as follows:

PC D-SUB, PC HDMI, AV HDMI, AV COMPONENT and AV VIDEO

When the PN-ZB02 (optional) is attached:

PC DVI-D, PC HDMI, PC D-SUB, PC RGB, AV DVI-D, AV HDMI, AV COMPONENT, AV S-VIDEO and AV VIDEO

(Input mode switching may take 15 seconds or more, depending on the connected equipment. Input signals may not be detected properly and a priority may change, depending on the connected equipment or video signals.)

FAN SPEED

Sets the rotation speed of the fan.

As this number increases, the rotation speed becomes faster. When set to AUTO, the rotation speed of the fan will change depending on the internal temperature.

SIZE

Selects screen size. (See page 20.)

MUTE AUDIO

Can temporarily turn off the volume.

INFORMATION

If you press , monitor information can be checked.

■MULTI**ENLARGE (See page 28.)**

Sets whether or not to use the enlarge function.

ADVANCED (ENLARGE)**ENLARGE H / ENLARGE V**

..... Sets the number of screen splits (number of monitors) in the horizontal/vertical direction used for the enlargement.

ENLARGE-POS

..... Specify the split screen to be displayed when the enlargement function is used.

H-POS / V-POS

..... Adjust the horizontal/vertical position of the enlarged screen.

BEZEL ADJUST

Sets whether or not to use the frame correction function.

ADVANCED (BEZEL ADJUST)**BEZEL ADJUST (TOP) / BEZEL ADJUST (BOTTOM) / BEZEL ADJUST (RIGHT) / BEZEL ADJUST (LEFT)**

..... Adjusts so that the top/bottom/left/right connecting joints of grouped units will be displayed smoothly when a group of monitors are aligned in multiples to display a single image.

BEZEL (TOP) / BEZEL (BOTTOM) / BEZEL (RIGHT) / BEZEL (LEFT)

..... Sets the frame width of the display.

■PIP/PbyP**PIP MODES**

Sets the display method.

OFFDisplays one screen.

PIPDisplays a sub screen inside a main screen.

PbyPDisplays a main screen and a sub screen in a line.

PbyP2Displays a main screen which measures 1024 pixels in the longest direction and a sub screen in a line.

PIP SIZE

Sets the size of the sub screen in PIP mode.

PIP H-POS

Adjusts the horizontal position of the sub screen in PIP mode.

PIP V-POS

Adjusts the vertical position of the sub screen in PIP mode.

PIP BLEND

In PIP mode, use this menu item to display the sub screen transparently.

PIP SOURCE

Selects the input signal of the sub screen in PIP, PbyP, or PbyP2 mode.

SOUND CHANGE

Sets the sound which is output in PIP, PbyP, or PbyP2 mode. If the main screen is displayed as a full screen by the AUTO OFF function, the sound for the main screen is output even when the sound for the sub screen is specified.

MAIN POS

Sets the position of the main screen in PbyP or PbyP2 mode.

PbyP2 POS

Sets the position of the sub screen in PbyP2 mode.

AUTO OFF

Sets the display method when no signals for the sub screen are input in PIP, PbyP, or PbyP2 mode.

MANUAL Displays a main screen and a black sub screen.

AUTO Displays the main screen as a full screen.

TIPS

- When WHITE BALANCE is set to THRU, BLACK LEVEL, CONTRAST, TINT, COLORS, RGB INPUT RANGE, GAMMA, and COPY TO USER cannot be set.
- If COLOR MODE is set to sRGB, the following items cannot be set.
WHITE BALANCE, PRESET, USER, COPY TO USER, and GAMMA
- When the COLOR MODE is set to VIVID or HIGH ILLUMINANCE, GAMMA can not be adjusted.
- STANDBY MODE cannot be set to LOW POWER when SCHEDULE is effective or when OFF is selected for LED in FUNCTION.
- When displaying the color pattern, it is possible to adjust certain items of the PICTURE menu.
Non-adjustable items cannot be selected.
Audio input from the HDMI input terminal is also not output.

Menu Items

■Dual screen display

You can display the screens of the PC input signal and AV input signal simultaneously.
Set this function with "PIP MODES" in the PIP/PbyP menu.

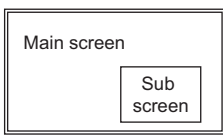
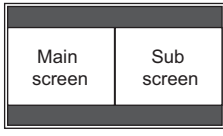
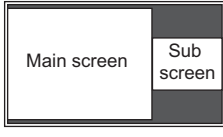
PIP		A sub screen is displayed inside a main screen.
PbyP		A main screen and a sub screen are displayed in a line.
PbyP2		Displays a main screen which measures 1024 pixels in the longest direction and a sub screen in a line.

- * The currently selected input signal is displayed on the main screen.
- * You cannot simultaneously display the screens of signals of the same type, such as two types of PC input signals or two types of AV input signals.
- * The dual screen display cannot be used with the combination of PC DVI-D and AV HDMI or of AV DVI-D and PC HDMI.

TIPS

- You might infringe on a copyright of the author which is protected by copyright law when you display the images of the computer screen and television/VCR simultaneously for profit-making or to show the image to the public.
- The screen size for dual-screen display is the same as the screen size for single-screen display. The Dot by Dot screen is displayed in NORMAL size except when it is set as the PIP main screen.
- When dual-screen display is selected, the AUTO INPUT CHANGE function is disabled.
- When dual-screen display is selected, the screen cannot be enlarged.
- When dual-screen display is selected, the INPUT SELECT options cannot be set.
- When an interlaced signal (1080i, 480i, video, S-Video) is input to the sub screen, horizontal lines may flicker. If this happens, display the image on the main screen.

■Enlarge

- You can align several monitors and integrate them into a single large screen to display.
- Up to five monitors can be aligned in both the horizontal and vertical directions.
- Each monitor displays enlarged views of separated images.

(Example)

Horizontal direction: 2 monitors

Vertical direction: 2 monitors

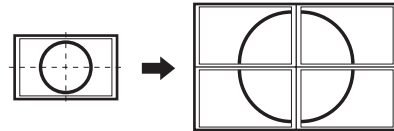





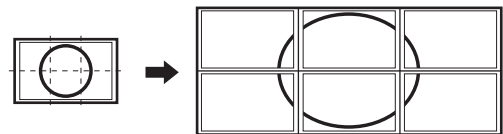

Horizontal direction: 3 monitors

Vertical direction: 2 monitors



Setting procedure

Set using the MULTI menu.

1. Set **ENLARGE** to **ON**.
2. Select **ADVANCED (ENLARGE)**.
3. Set the number of monitors aligned in the horizontal direction in **ENLARGE H**.
4. Set the number of monitors aligned in the vertical direction in **ENLARGE V**.
5. Set the section of the separated image to be displayed on each monitor in **ENLARGE-POS**.
 - 1) Press .
 - 2) Press , ,  or  to select position, then press .

TIPS

- When Enlarge is used, the AUTO INPUT CHANGE function is disabled.
- When Enlarge is used, the HDMI AUTO VIEW function is disabled.

■ ZOOM2 SPECIAL SETTING

If you connect a laptop computer with any of the following screen resolutions and black bands appear around the screen, set ZOOM2 SPECIAL SETTING of INPUT SIGNAL on the OPTION menu to ON and then select ZOOM2 in the SIZE setting.

This displays the area inside the black band.

Laptop computer resolution	Corresponding signal*1
1280x800	1280x1024, 1280x960, 1400x1050*2
1280x600	1280x720
1024x600	1024x768

*1: This setting is effective only when the screen resolution, including the black band, is one of the resolutions listed above.

*2: Use the automatic screen adjustment.

■ SCHEDULE

You can set the time to switch the monitor on and off.

Set this function with "SCHEDULE" in the OPTION menu. (See page 26.)

When BRIGHT is set, set BRIGHTNESS SENSOR to OFF on the SETUP menu.

No.	(1) POWER	(2) DAY OF THE WEEK	(3) TIME	(4) INPUT	(5) BRIGHT
1	-	--	--	--	--
2	-	--	--	--	--
3	-	--	--	--	--
4	-	--	--	--	--
5	-	--	--	--	--
6	-	--	--	--	--
7	-	--	--	--	--
8	-	--	--	--	--

1366x768 V: 60 Hz H: 47.7 kHz OK--[MENU]

- Press or to select the SCHEDULE number, and press .
- Set the SCHEDULE. (See the description below.)
Press or to select items, and press or to change the setting.
- Press .
SCHEDULE becomes effective.

(1)

- : SCHEDULE effective
- : SCHEDULE not effective

(2) POWER

ON : Switches the monitor on at the specified time.

OFF: Switches the monitor off at the specified time and puts the monitor in standby mode.

(3) DAY OF THE WEEK

Specifies the day of the week to execute the SCHEDULE.

0: ONLY ONCE

Executes the SCHEDULE once on the specified day.

Specify the day of the week to execute the SCHEDULE.

1: EVERY WEEK

Executes the SCHEDULE on the specified day of the week every week. Specify the day of the week to execute the SCHEDULE.

Periodic setting such as "Monday through Friday" is also possible.

2: EVERY DAY

Executes the SCHEDULE every day regardless of the day of the week.

(4) TIME

Specifies the time to execute the SCHEDULE.

Set the time on a 24-hour basis. (Factory default)

Can be entered as 12-hour time using the TIME setting in DATE/TIME FORMAT.

(5) INPUT

Specifies the input mode at power-on. When not specifying, the screen at the previous power-off appears.

Input modes displayed on DVI, HDMI, BNC and D-SUB depend on INPUT SELECT settings.

(6) BRIGHT

Sets the brightness when changing the screen brightness at a specified time.

! Caution

- Do not switch off the main power after setting the SCHEDULE.
- Specify the correct date and time. (See page 26.)
SCHEDULE does not function unless the date and time are specified.
- Check regularly that the set date and time are correct.
- When STANDBY MODE is LOW POWER, SCHEDULE cannot be set.
- When a temperature abnormality occurs and the backlight brightness is reduced, the brightness is not changed even if a schedule set to BRIGHT is executed.

TIPS

- Up to 8 SCHEDULE items can be registered.
- Setting the SCHEDULE flashes the power LED alternately in red and orange in standby mode.
- A SCHEDULE that has a large number has precedence over that of a small number when schedules overlap.
- If D-SUB of INPUT SELECT on the OPTION menu is set to AV VIDEO, the input mode will switch to AV VIDEO (D-SUB) regardless if set to D-SUB or VIDEO.

■ADVANCED items (AV input) (See page 23 for additional Menu item details.)

FLESH TONE

Adjust the hue control.

3D-NR

Reduce the noise of playback images on video. Setting a higher level reduces more noise. However, it may cause blurring on an image.

MPEG-NR

Reduce block noise caused by digital compression.

3D-Y/C (AV VIDEO)

Specify whether to perform 3-dimension Y/C separation. If dot interference or cross-color is occurring in fast-motion scenes, selecting OFF may improve the image quality.

C.M.S.-HUE

Adjusts color tone with 6 colors of R (red), Y (yellow), G (green), C (cyan), B (blue), and M (magenta).

C.M.S.-SATURATION

Adjusts color vividness with 6 colors of R (red), Y (yellow), G (green), C (cyan), B (blue), and M (magenta).

C.M.S.-VALUE

Adjusts color brightness with 6 colors of R (red), Y (yellow), G (green), C (cyan), B (blue), and M (magenta).





TIPS

- When FLESH TONE is set to LOW or HIGH, C.M.S.-HUE/-SATURATION/-VALUE cannot be set.

Adjustments for PC screen display

■Automatic adjustment

When you use the PC D-sub input terminal or PC RGB input terminals to display a PC screen for the first time, or when you change the setting of the PC, use the automatic screen adjustment.

1. **Switch the input to PC D-SUB or to PC RGB and display the adjustment pattern.** (See the description below.)
2. Press  and use  or  to display the SCREEN menu.
3. Press  and select "AUTO".
4. Press .

The automatic adjustment is complete in several seconds.
5. Press  twice to close the menu screen.

TIPS

- If the screen cannot be adjusted properly with one automatic adjustment, repeat the automatic adjustment two or three times. Try manual adjustment if necessary.

■Screen display for adjustment

Before making adjustments in the SCREEN menu or PICTURE menu, display an image to brighten the entire screen. If you are using a Windows PC, use the adjustment pattern on the supplied CD-ROM.

Opening the adjustment pattern

The following example is performed in Windows 7.

1. **Load the supplied CD-ROM into the computer's CD-ROM drive.**
2. **Open [CD Drive] in [Computer].**
In Windows XP, open [CD Drive] in [My Computer].
3. **Double-click [Adj_uty.exe].**
The adjustment pattern will appear.
Adjust the screen automatically or manually.

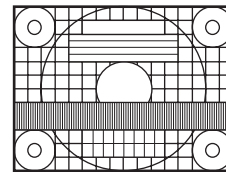

4. **When adjustment is finished, press the [Esc] on the computer's keyboard to quit the adjustment program.**
5. **Eject the CD-ROM from the CD-ROM drive.**

TIPS

- If the display mode on the computer you are using is 65,000 colors, the color levels in the color pattern may appear differently or grayscale may appear to be colored. (This is due to the specifications of the input signal and is not a malfunction.)

Initialization (Reset)/Functional Restriction Setting (FUNCTION)

You can return the settings to their factory-preset values and restrict operations.

1. If using the remote control unit, press until "F" is displayed in the upper left area of the screen, then while "F" is being displayed, press , , , and in that order.

If using the monitor buttons, press and at the same time until "F" is displayed in the upper left area of the screen, then while "F" is being displayed, press and at the same time.

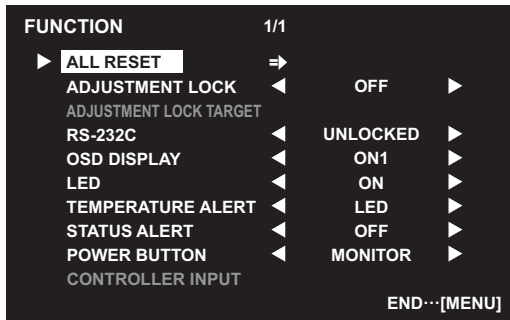

2. Select and set the items.

ALL RESET

Resets the settings to the factory default settings. Press , select ALL RESET, and then press . After initialization, turn the main power switch off and then back on.

When the PN-ZB02 (optional) is attached, press , select the resetting method, and then press .

ALL RESET1Resets all the settings to the factory default settings.

ALL RESET2Returns all settings to the factory default settings except for the following items: LAN SETUP, RS-232C/LAN SELECT, ID No. SET, BAUD RATE, NETWORK, MAIL, SERVICE & SUPPORT, and SNMP (See pages 24, 25, and pages 49 to 52.)

ADJUSTMENT LOCK

You can disable operations on the monitor and the remote control unit that use buttons.

OFF ... Enables operation.

ON 1 ..Disables all operations other than turning power on/off, FUNCTION, and REMOTE CONTROL MODE.

ON 2 ..Only the FUNCTION and REMOTE CONTROL MODE operations are enabled. Disables all operations other than FUNCTION and REMOTE CONTROL MODE (not even power on/off).

ADJUSTMENT LOCK TARGET

Sets the target to prohibit operation of with ADJUSTMENT LOCK.

REMOTE CONTROL ...Prohibits remote control operation

MONITOR BUTTONS....Prohibits monitor button operation

BOTH.....Prohibits remote control and monitor button operation

RS-232C

(RS-232C/LAN when the PN-ZB02 (optional) is attached)

Specifies whether to allow control via RS-232C or LAN (see pages 32 and 45).

OSD DISPLAY

Shows/hides the menu, modes, and messages. The FUNCTION and REMOTE CONTROL MODE screens cannot be hidden.

ON 1 Shows all menus, modes, and messages.

ON 2 Hides messages automatically displayed by the display. Shows messages during operation.

OFF Hides all menus, modes, and messages.

LED

Specifies whether to light the power LED.

OFF cannot be selected when STANDBY MODE is LOW POWER.

TEMPERATURE ALERT

Selects the notification method for an abnormal temperature.

OFF Do not notify about an abnormal temperature.

OSD & LED .. When an abnormal temperature is detected, the power LED flashes in red and green alternately and the screen displays a message: TEMPERATURE.

LED..... When an abnormal temperature is detected, the power LED flashes in red and green alternately.

STATUS ALERT

Selects the notification method for a hardware error.

OFF Do not notify about the error.

OSD & LED .. When a hardware error is detected, the power LED flashes in red and the screen displays a message: STATUS [xxxx].

LED..... When a hardware error is detected, the power LED flashes in red.

POWER BUTTON

Normally, leave this setting as MONITOR.

When using an optional part, if instruction appears, change the setting accordingly.

CONTROLLER INPUT

Normally, you do not need to change this setting.

When using an optional part, if instruction appears, change the setting accordingly.

3. Press to return to the normal screen.

TIPS

- When both abnormal temperature and hardware error are detected, the hardware error notification overrides.
- If OSD DISPLAY is set to either ON 2 or OFF, an error notification is displayed when TEMPERATURE ALERT or STATUS ALERT is set to OSD & LED.

Controlling the Monitor with a PC (RS-232C)

You can control this monitor from a PC via RS-232C (COM port) on the PC.

You can also connect multiple monitors via a daisy chain by using a PC. By assigning ID numbers to each monitor (see page 34), you can make input mode selection/adjustment or can check the status of a specific monitor.

Precautions when the PN-ZB02 (optional) is attached

- To control the monitor via RS-232C, set RS-232C/LAN SELECT to RS-232C.
- You cannot use RS-232C and LAN control simultaneously.

PC connection

One-to-one connection with a PC

Connect with RS-232 straight cable between the PC's COM port (RS-232C connector) and the RS-232C input terminal on the monitor.

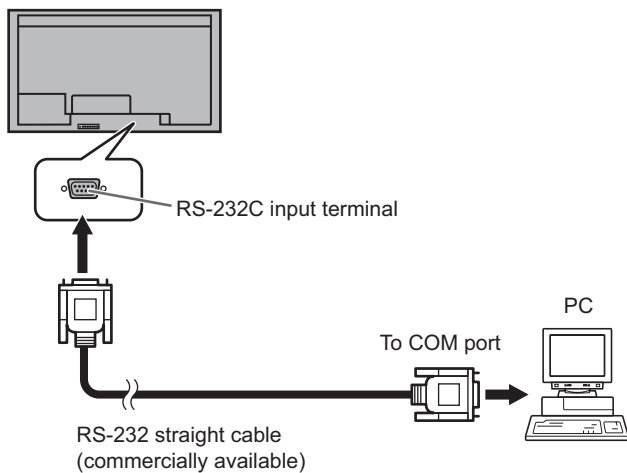

Daisy chain connection... Advanced operation

Connect with RS-232 straight cable between the PC's COM port (RS-232C connector) and the RS-232C input terminal on the first monitor.

Next, connect RS-232 straight cable to the first monitor's RS-232C output terminal and to the second monitor's RS-232C input terminal. Connect in the same way to the third and subsequent monitors.

Up to 25 monitors can be connected. (Depending on the length of the cable used and the surrounding environment.)

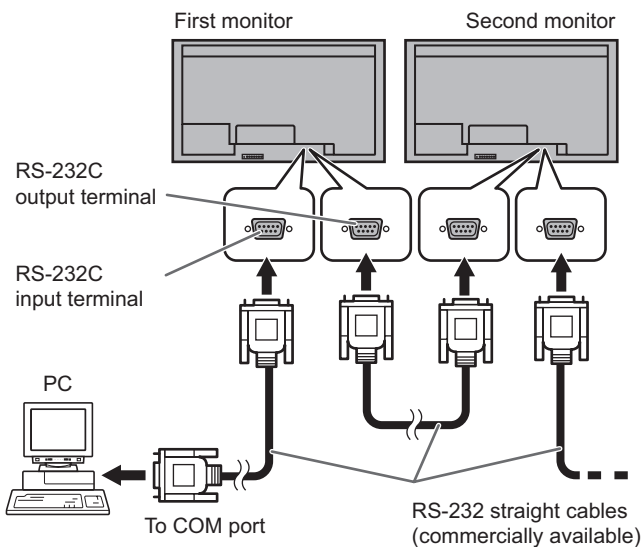

Communication conditions

Set the RS-232C communication settings on the PC to match the monitor's communication settings as follows:

Baud rate	*
Data length	8 bits
Parity bit	None

Stop bit	1 bit
Flow control	None

* Set to the same baud rate as the BAUD RATE setting of SETUP menu. (Initial setting: 38400 bps)

* When connecting multiple monitors in a daisy chain, set all monitors to the same BAUD RATE.

Communication procedure

Command format

When a command is sent from the PC to the monitor, the monitor operates according to the received command and sends a response message to the PC.

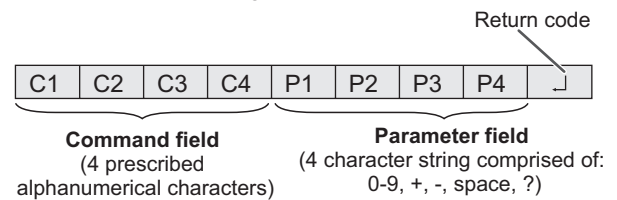

Example: VOLM0030
VOLM _ _ 30

* Be sure to input 4 characters for the parameter. Pad with spaces (" ") if necessary.

("␣" is a return code (0DH, 0AH or 0DH))

Wrong : VOLM30␣

Right : VOLM _ _ 30␣

When inputting a negative value, specify a numerical value in three digits.

Example: AUTC-005

Do not use spaces for MPOS, DATE, and SC01 through SC08. Specify parameters using a specified number of characters.

Example: MPOS010097

If a command has "R" listed for "DIRECTION" in the "RS-232C command table" on page 37, the current value can be returned by using "?" as the parameter.

Example:

VOLM ? ? ? ? ← From PC to monitor (How much is current volume setting?).

30 ← From monitor to PC (Current volume setting: 30).

* If an ID number (see page 33) has been assigned (For example, ID number = 1).

VOLM _ _ _ ? ← From PC to monitor.

30 _ 001 ← From monitor to PC.

Response code format

When a command has been executed correctly

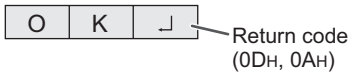

A response is returned after a command is executed.

- * If an ID number has been assigned

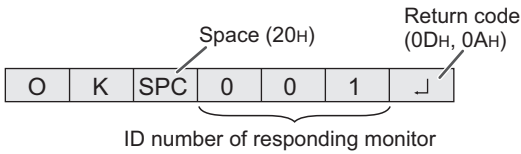

When a command has not been executed



- * If an ID number has been assigned

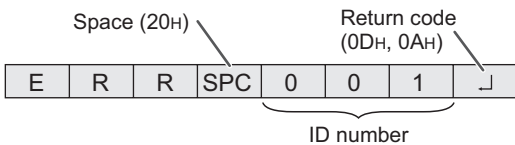

TIPS

- "ERR" is returned when there is no relevant command or when the command cannot be used in the current state of the monitor.
- If communication has not been established for reasons such as a bad connection between the PC and monitor, nothing is returned (not even ERR).
- "ERR" may be returned when a command can't be received correctly due to interference from the surrounding environment.
Please ensure that the system or software retries the command if this occurs.
- If no monitor has been assigned the designated ID number (e.g. if the command IDSL0002 is used, but no monitor with ID number: 2 is found), no response is returned.

If execution of the command is taking some time



When the following commands are used, "WAIT" is returned. In this case, a value will be returned if you wait a while. Do not send any command during this period.

No ID number is attached to WAIT response.

- Commands which return WAIT:
 1. When repeater control is used
 2. When an IDSL or IDLK command is used
 3. When one of the following commands is used: RSET, INPS, ASNC, WIDE, EMAG, EPOS, PXSL, POWR, AGIN, MWIN, MWIP, MWPP, ESTG, EMHV, EPHV, ESHV, ENLG

When control via RS-232C is locked (to prevent use) using the operation lock function (see page 31)



When RS-232C/LAN SELECT is set to LAN

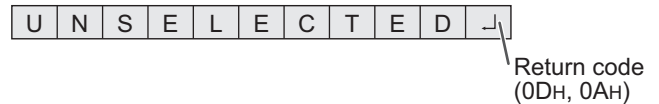

Communication interval

- After OK or ERR is returned, you must send the following commands.

To set a timeout for the command response, specify 10 seconds or longer.

When connecting multiple monitors in a daisy chain, set the timeout to at least the product of the monitor's position from the computer multiplied by 10 seconds.

Example) 3rd monitor from computer: 30 seconds or longer.

- Provide an interval of 100 ms or more between the command response and the transmission of the next command.

VOLM0020
OK

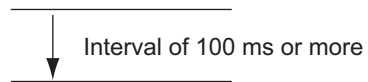

INPS0001
WAIT
OK

TIPS

- When executing ALL RESET, set the timeout period to 30 seconds or longer.
- When turning the power on while the POWER ON DELAY function is in use, set the timeout period to the POWER ON DELAY period + 10 seconds or longer.

Controlling the Monitor with a PC (RS-232C)

Advanced operation

This section explains commands for daisy chain connection. The basic communication procedure is the same as in the "One-to-one connection with a PC" section.

■ID numbers

You can assign a unique ID number to each monitor (see page 24). This allows you to control a particular monitor in a daisy chain of monitors.

You can assign ID numbers either from the menu screen or from the PC using RS-232 cable.

[Example]

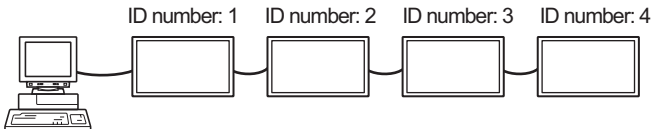

If monitors are connected as shown above, you can execute commands like "Set the volume of the monitor with ID 4 to 20".

When designating ID numbers for a set of monitors linked in a daisy chain, you should basically avoid any duplication of ID numbers.

ID numbers do not have to be assigned in ascending order starting from the PC. They can also be connected as shown below.

[Example]

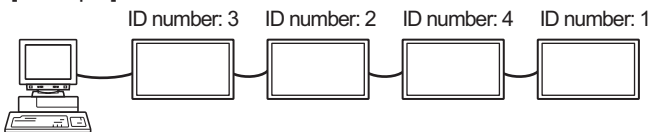

■Commands for ID control

The command examples shown on this page assume the following connection and ID number set up.

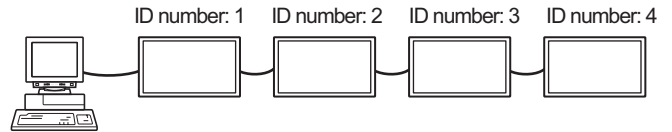

IDSTA monitor receiving this command sets its own ID number in the parameter field.

Example:

IDST0001

OK _ 001 ← The ID number of this monitor is set to 1.

TIPS

You can automatically assign ID numbers by using the IDST command with the Repeater control (see "Repeater control" on page 35).

For example, using the command "IDST001+" automatically sets the ID numbers, as shown below.

[Example]

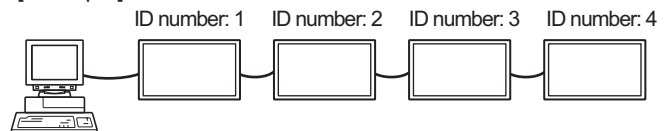

IDST001 + ← ID setting command with repeater control

WAIT

OK _ 001 ← "OK" response from ID number: 1

OK _ 002 ← "OK" response from ID number: 2

OK _ 003 ← "OK" response from ID number: 3

OK _ 004 ← "OK" response from ID number: 4 (End)

IDSLThe parameter of this command sets the ID number of the monitor. The monitor is subject to the next command.

Example:

IDSL0002 ← The next command is for the monitor with ID number: 2.

WAIT ← Searching for monitor with ID number: 2

OK _ 002 ← Found monitor with ID number: 2

VOLM0030 ← Sets volume of monitor with ID number: 2 to 30.

WAIT ← Processing

OK _ 002 ← OK response from monitor with ID number: 2

VOLM0020 ← Sets volume to 20.

OK _ 001 ← The volume of the monitor with ID number: 1 (the one directly connected to the PC) is set to 20.*

* The IDSL command is effective only once, for the immediately succeeding command.

IDLKThe parameter of this command sets the ID number of the monitor. The monitor is subject to all subsequent commands.

Example:

```

IDLK0002 ← Following commands are for the monitor
           with ID number: 2.

WAIT ← Searching for monitor with ID number:
      2

OK _ 002 ← Found monitor with ID number: 2

VOLM0030 ← Sets volume of monitor with ID
           number: 2 to 30.*

WAIT ← Processing

OK _ 002

VOLM0020 ← Sets volume of monitor with ID
           number: 2 to 20.*

WAIT

OK _ 002

IDLK0000 ← Canceling fixed ID number setting

WAIT ← Canceling IDLK

OK _ 002 ← Cancellation complete

VOLM0010

OK _ 001 ← The volume of the monitor with ID number:
           1 (the one directly connected to the PC) is
           set to 10. (IDLK is canceled.)
    
```

* The IDLK command remains effective until it is canceled, or power is shut off.

IDCK.....Provides screen display of the ID number currently assigned to a monitor, and the ID number currently set for IDLK (if any).

Example:

(After executing IDLK0002)

```

IDCK0000 ← (Parameter has no meaning.)

ID : 001 IDLK : 002 ← Returned response. The ID
                    number is also displayed on the
                    monitor screen.

IDCK000 + ← Repeater control. (If a command
            is used with repeater control, ID
            designation using IDSL or IDLK
            is canceled.)

WAIT

ID : 001 IDLK : 000
ID : 002 IDLK : 000
ID : 003 IDLK : 000
ID : 004 IDLK : 000
    
```

■ Repeater control

This system has a function to allow setting of multiple monitors connected in a daisy chain using a single command. This function is called repeater control. You can use Repeater control function without assigning ID numbers.

[Example]

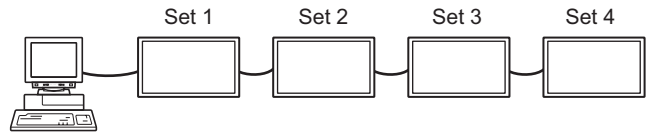

* If monitors are connected as shown above, you can execute a command like "Set all monitors' input settings to PC D-SUB".

RS-232C command table

How to read the command table

- Command: Command field (See page 32.)
- Direction: W When the "Parameter" is set in the parameter field (see page 32), the command functions as described under "Control/Response Contents".
 R The returned value indicated under "Reply" can be obtained by setting "????", "____?" or "???" (repeater control) in the parameter field (see page 32).
- Parameter: Parameter field (See page 32.)
- Reply: Response (Returned value)
- *1: "●" indicates a command which can be used in power standby mode regardless of the STANDBY MODE setting.
 "○" indicates a command which can also be used in power standby mode when STANDBY MODE is set to STANDARD.
 "—" indicates a command which cannot be used in power standby mode regardless of the STANDBY MODE setting.
- *2: PN-ZB02 (optional) limitations
 (A) When PN-ZB02 (optional) is not attached, (B) When PN-ZB02 (optional) is attached.
 ○ : The command can be used.
 - : Error (ERR)

Power control/Input mode selection

Function	Command	Direction	Parameter	Reply	Control/Response contents	*2		
						*1	(A) (B)	
POWER CONTROL	POWR	W	0		Switches to standby mode.			
			1		Returns from standby mode.			
		R		0	Standby mode	●	○ ○	
				1	Normal mode			
				2	Input signal waiting mode			
INPUT MODE SELECTION	INPS	W	0		Toggle change for input mode. Terminals not selected in INPUT SELECT cannot be selected.		○ ○	
			1		PC DVI-D "ERR" when AV DVI-D is selected for DVI of INPUT SELECT.		- ○	
			2		PC D-SUB "ERR" when other than PC D-SUB is selected for D-SUB of INPUT SELECT.		○ ○	
			3		AV COMPONENT (BNC)/AV COMPONENT (D-SUB) "ERR" when other than PC RGB is selected for BNC of INPUT SELECT, and when other than AV COMPONENT is selected for D-SUB of INPUT SELECT.	●	○ ○	
			4		AV VIDEO (BNC)/AV VIDEO (D-SUB)		○ ○	
			6		PC RGB "ERR" when AV COMPONENT is selected for BNC of INPUT SELECT.		- ○	
			7		AV DVI-D "ERR" when PC DVI-D is selected for DVI of INPUT SELECT.		- ○	
			8		AV S-VIDEO		- ○	
			9		AV HDMI "ERR" when PC HDMI is selected for HDMI of INPUT SELECT.		○ ○	
			10		PC HDMI "ERR" when AV HDMI is selected for HDMI of INPUT SELECT.		○ ○	
		R		1	PC DVI-D			
				2	PC D-SUB			
				3	AV COMPONENT			
				4	AV VIDEO			
				6	PC RGB		●	○ ○
				7	AV DVI-D			
				8	AV S-VIDEO			
				9	AV HDMI			
					10	PC HDMI		

Controlling the Monitor with a PC (RS-232C)

SCREEN menu

Function		Command	Direction	Parameter	Reply	Control/Response contents	*1	*2	
								(A)	(B)
AUTO		ASNC	W	1		When the input mode is PC D-SUB, PC RGB.			
CLOCK		CLCK	WR	0-1200	0-1200	When the input mode is PC D-SUB, PC RGB. Varies depending on the signal.			
PHASE		PHSE	WR	0-63	0-63	When the input mode is PC D-SUB, PC RGB.			
POSITIONING	POSITION OF THE LONGEST DIRECTION	HPOS	WR	0-100	0-100	0-800 on PC D-SUB, PC RGB. Varies depending on the signal.			
	POSITION OF THE SHORTEST DIRECTION	VPOS	WR	0-100	0-100	0-200 on PC D-SUB, PC RGB. Varies depending on the signal.			
SIZE	POSITION OF THE LONGEST DIRECTION	HSIZ	WR	0-100	0-100		-	○	○
	POSITION OF THE SHORTEST DIRECTION	VSIZ	WR	0-100	0-100				
RESOLUTION	LONGEST DIRECTION RESOLUTION	HRES	WR	300-1920	300-1920	When the input mode is PC D-SUB, PC RGB. Only even numbers are valid for parameters. Varies depending on the signal.			
	SHORTEST DIRECTION RESOLUTION	VRES	WR	200-1200	200-1200				
RESET		ARST	W	1					

Controlling the Monitor with a PC (RS-232C)

PICTURE menu

Function	Command	Direction	Parameter	Reply	Control/Response contents	*1	*2			
						(A)	(B)			
AUTO	AGIN	W	1		When the input mode is PC D-SUB, PC RGB.	-				
ANALOG GAIN	ANGA	WR	0-127	0-127	When the input mode is PC D-SUB, PC RGB.					
ANALOG OFFSET	ANOF	WR	0-127	0-127	When the input mode is PC D-SUB, PC RGB.					
CONTRAST	CONT	WR	0-60	0-60						
BLACK LEVEL	BLVL	WR	0-60	0-60						
TINT	TINT	WR	0-60	0-60						
COLORS	COLR	WR	0-60	0-60						
SHARPNESS	SHRP	WR	0-24	0-24		○	○			
RGB INPUT RANGE (AV HDMI)	AHDR	WR	0-2	0-2	0: AUTO, 1: FULL, 2: LIMITED					
RGB INPUT RANGE (PC HDMI)	PHDR	WR	0-2	0-2	0: AUTO, 1: FULL, 2: LIMITED					
RGB INPUT RANGE (AV DVI)	ADVR	WR	1-2	1-2	1: FULL, 2: LIMITED					
RGB INPUT RANGE (PC DVI)	PDVR	WR	1-2	1-2	1: FULL, 2: LIMITED					
RGB INPUT RANGE (D-SUB)	PDSR	WR	1-2	1-2	1: FULL, 2: LIMITED					
RGB INPUT RANGE (PC BNC)	PBRR	WR	1-2	1-2	1: FULL, 2: LIMITED					
ADVANCED (When the input mode is AV.)	FLESH TONE	FLES	WR	0-2	0-2	0: OFF, 1: LOW, 2: HIGH	○			
	3D-NR	TDNR	WR	0-2	0-2	0: OFF, 1: LOW, 2: HIGH				
	MPEG-NR	MPNR	WR	0-1	0-1	0: OFF, 1: ON				
	3D-Y/C	YCSP	WR	0-1	0-1	0: OFF, 1: ON (When the input mode is AV VIDEO)				
	C.M.S.-HUE	CMHR	WR	-10-10	-10-10	R				
						Y				
						G				
						C				
						B				
						M				
	CRST	W	1			Resets the hue.				
	C.M.S.-SATURATION	CMSR	WR	-10-10	-10-10	R				
						Y				
						G				
						C				
						B				
						M				
	CRST	W	2			Resets the saturation.				
	C.M.S.-VALUE	CMVR	WR	-10-10	-10-10	R				
						Y				
G										
C										
B										
M										
CRST	W	3			Resets the brightness.					
COLOR MODE	BMOD	WR	0	0	STD					
			2	2	VIVID					
			3	3	sRGB (When the input mode is PC)					
			4	4	HIGH ILLUMINANCE					
WHITE BALANCE	THRU	CTMP	WR	0	0	When the input mode is PC DVI-D/PC HDMI.	○			
	PRESET			1-18	1-18	From 1: approximately 3,000K to 15: approximately 10,000K (500K steps) 16: approximately 5,600K, 17: approximately 9,300K, 18: approximately 3,200K				
	USER			99	99					
	R-CONTRAST			CRTR	WR	0-256	0-256	"ERR" when CTMP is not set to 99.		
	G-CONTRAST			CRTG	WR	0-256	0-256			
	B-CONTRAST			CRTB	WR	0-256	0-256			
	R-OFFSET			OFSR	WR	-127-127	-127-127			
	G-OFFSET			OFSG	WR	-127-127	-127-127			
B-OFFSET	OFSB	WR	-127-127	-127-127						
COPY TO USER	CPTU	W	0		Copies a preset value to the user setting.	-				
GAMMA	GAMM	WR	0-2	0-2	0: 1.8, 1: 2.2, 2: 2.4 (during PC input) 0: LIGHT 2, 2: DARK (during AV input)					
			4-6	4-6	4: USER, 5: 2.0, 6: STD (during PC input) 4: USER, 5: LIGHT 1, 6: STD (during AV input)					
LOCAL DIMMING	LODI	WR	0-3	0-3	0: OFF, 1: LOW, 2: MIDDLE, 3: HIGH					
POWER LIMITED	PWSV	WR	0-2	0-2	0: OFF, 1: MODE1, 2: MODE2 "ERR" when LOCAL DIMMING is not set to HIGH.					
DISPLAY COLOR PATTERN	PTDF	WR	0	0	No pattern display.					
			1	1	White single color pattern display.					
			2	2	Red single color pattern display.					
			3	3	Green single color pattern display.					
			4	4	Blue single color pattern display.					
			99	99	Red/green/blue mixed color pattern display. Set each color's level with RED, GREEN, BLUE.					
RED	PTDR	WR	0-15	0-15	"ERR" when PTDF is not set to 99.					
GREEN	PTDG	WR	0-15	0-15						
BLUE	PTDB	WR	0-15	0-15						
RESET	ARST	W	2			-				

Controlling the Monitor with a PC (RS-232C)

AUDIO menu

Function	Command	Direction	Parameter	Reply	Control/Response contents	*1	*2	
							(A)	(B)
TREBLE	AUTR	WR	-5-5	-5-5				
BASS	AUBS	WR	-5-5	-5-5		○	○	○
BALANCE	AUBL	WR	-10-10	-10-10				
RESET	ARST	W	3			-		

SETUP menu

Function	Command	Direction	Parameter	Reply	Control/Response contents	*1	*2		
							(A)	(B)	
OSD H-POSITION	OSDH	WR	0-100	0-100		○			
OSD V-POSITION	OSDV	WR	0-100	0-100					
MONITOR	STDR	WR	0-1	0-1	0: LANDSCAPE, 1: PORTRAIT	○			
LANGUAGE	LANG	WR	14	14	ENGLISH	○			
			1	1	DEUTSCH				
			2	2	FRANÇAIS				
			3	3	ITALIANO				
			4	4	ESPAÑOL				
			5	5	РУССКИЙ				
POWER ON DELAY	PWOD	WR	0	0	OFF	○			
			1-60	1-60	ON				
OPERATION MODE	FNCM	WR	0-1	0-1	0: MODE1, 1: MODE2	○			
STANDBY MODE	STBM	WR	0-1	0-1	0: STANDARD, 1: LOW POWER ("ERR" when SCHEDULE is effective or OFF is selected for LED.)	○			
OFF IF NO OPERATION	ATOF	WR	0-1	0-1	0: OFF, 1: ON	○			
HOT PLUG CONTROL (DVI)	HPCT	WR	0-1	0-1	0: OFF, 1: ON	○	-	○	
HOT PLUG CONTROL (HDMI)	HPCH	WR	0-1	0-1	0: OFF, 1: ON	○	○	○	
RS-232C/LAN SELECT	CTLS	WR	0-1	0-1	0: RS-232C, 1: LAN	○	-	○	
ID NUMBER	ID NO. SETTING	IDST	W	0-255		Sets the monitor's ID number. ("0" means "no ID number".)	○		
					0-255	Returns the monitor's ID number.			
	ID NO. SETTING (ONCE)	IDSL	W	1-255		Sets a monitor ID number. This ID number is only effective for the command immediately after this command.			
				0		Clears the ID number if one has been designated.			
	ID NO. SETTING (SUBSEQUENT)	IDLK	W	1-255		Sets a monitor ID number. This ID number is effective for the next and all subsequent commands after this command.			
0					Clears the ID number if one has been designated.				
ID CHECK	IDCK	W	0	ID : xxx IDLK : yyy	Displays monitor's own ID number and the selected ID number on the screen.				
BAUD RATE	BAUD	WR	0-2	0-2	0: 9600bps, 1: 19200bps, 2: 38400bps	○	○	○	
OPTION DC OUT SETTING	DCOT	WR	0-2	0-2	0: OFF, 1: MODE1, 2: MODE2	-	○	○	
HDMI AUTO VIEW	HDAW	WR	0-1	0-1	0: OFF, 1: ON	○	○	○	
BRIGHTNESS SENSOR (When connected to the PN-ZR01 (optional) only)	OPTS	WR	0-2	0-2	0: OFF, 1: ON, 2: ON: DISPLAY	○	○	○	
BRIGHTNESS SENSOR SETTING (When connected to the PN-ZR01 (optional) only)	WHEN DARK: AMBIENT BRIGHTNESS	OPSD	WR	0-99	0-99		○		
	WHEN DARK: SCREEN BRIGHTNESS	OPDD	WR	0-30	0-30				
	WHEN LIGHT: AMBIENT BRIGHTNESS	OPSL	WR	1-100	1-100				
	WHEN LIGHT: SCREEN BRIGHTNESS	OPDL	WR	1-31	1-31				
SETTING COPY MODE	CPMD	WR	0	0	Copy to all monitors.	○			
			1-225	1-225	Copy to the monitor with the set ID Number.				
SETTING COPY TARGET	CPTG	WR	0	0	Copies the PICTURE menu settings.	○			
			1	1	Copies all the settings.				
LOGO SCREEN	BTSC	WR	0-1	0-1	0: OFF, 1: ON				

Controlling the Monitor with a PC (RS-232C)

OPTION menu

Function	Command	Direction	Parameter	Reply	Control/Response contents	*1	*2 (A) (B)
DATE/TIME SETTING	DATE	WR	AABBCCDDEE	AABBCCDDEE	AA: Year, BB: Month, CC: Day, DD: Time, EE: Minute		
DATE DISPLAY FORMAT	DTFT	WR	0-2	0-2	0: YYYY/MM/DD, 1: MM/DD/YYYY, 2: DD/MM/YYYY YYYY: Year, MM: Month, DD: Day		
TIME DISPLAY FORMAT	TMFT	WR	0-1	0-1	0: 24-HOUR TIME, 1: 12-HOUR TIME		
SCHEDULE	SC01-SC08	WR	ABCDEFGGH	ABCDEFGGH	Schedule of a specified number A: Schedule 0= Not effective, 1 = Effective B: Power 0 = OFF, 1 = ON C: Day of the week 1 0 = Only once, 1 = Every week, 2 = Every day D: Day of the week 2 0 = Sunday, 1 = Monday through 6 = Saturday, 9 = Not exist E: Day of the week 3 0 = Sunday, 1 = Monday through 6 = Saturday, 9 = Not exist F: Time 00-23 G: Minute 00-59 H: Input 0 = Not specified, 1 = PC DVI-D/AV DVI-D, 2 = PC D-SUB, 3 = PC RGB/AV COMPONENT, 4 = AV VIDEO, 5 = AV S-VIDEO, 6 = PC HDMI/AV HDMI "ERR" when LOW POWER is selected for STANDBY MODE.	○	○ ○
SCHEDULE BRIGHTNESS	SB01-SB08	WR	0-31	0-31	Screen brightness to change		
			99	99	Disable brightness setting		
INPUT SELECT	DVI	DVSL	WR	0-1	0-1	0: PC DVI-D, 1: AV DVI-D	○ -
	BNC	BNSL	WR	0-1	0-1	0: PC RGB, 1: AV COMPONENT	○ -
	D-SUB	SLDS	WR	0-2	0-2	0: PC D-SUB, 1: AV COMPONENT, 2: AV VIDEO	○ ○
	HDMI	HDSL	WR	0-1	0-1	0: PC HDMI, 1: AV HDMI	○ ○
AUDIO SELECT	PC DVI-D	ASDP	WR	1-3	1-3	1: AUDIO(STEREO MINI), 2: AUDIO1(RCA), 3: AUDIO2(RCA)	-
	PC D-SUB	ASAP	WR	1-3	1-3	1: AUDIO(STEREO MINI) 2: AUDIO1(RCA), 3: AUDIO2(RCA)	○ -
	PC HDMI	ASHP	WR	0-1	0-1	0: HDMI, 1: AUDIO(STEREO MINI)	○
			2-3	2-3	2: AUDIO1(RCA), 3: AUDIO2(RCA)	-	
	PC RGB	ASCP	WR	1-3	1-3	1: AUDIO(STEREO MINI), 2: AUDIO1(RCA), 3: AUDIO2(RCA)	-
	AV DVI-D	ASDA	WR	1-3	1-3	1: AUDIO(STEREO MINI), 2: AUDIO1(RCA), 3: AUDIO2(RCA)	-
	AV HDMI	ASHA	WR	0-1	0-1	0: HDMI, 1: AUDIO(STEREO MINI)	○
			2-3	2-3	2: AUDIO1(RCA), 3: AUDIO2(RCA)	○ -	
	AV COMPONENT (BNC)	ASCA	WR	1-3	1-3	1: AUDIO(STEREO MINI), 2: AUDIO1(RCA), 3: AUDIO2(RCA)	-
	AV COMPONENT (D-SUB)	ASC2	WR	1-3	1-3	1: AUDIO(STEREO MINI), 2: AUDIO1(RCA), 3: AUDIO2(RCA)	○
	AV S-VIDEO	ASSA	WR	1-3	1-3	1: AUDIO(STEREO MINI), 2: AUDIO1(RCA), 3: AUDIO2(RCA)	-
	AV VIDEO (BNC)	ASVA	WR	1-3	1-3	1: AUDIO(STEREO MINI), 2: AUDIO1(RCA), 3: AUDIO2(RCA)	-
	AV VIDEO (D-SUB)	ASV2	WR	1-3	1-3	1: AUDIO(STEREO MINI), 2: AUDIO1(RCA), 3: AUDIO2(RCA)	○
INPUT RESOLUTION (PC)	RESOLUTION CHECK	PXCK	R	-	-	Returns current resolution in the form of hhh, vvv.	-
	PIXEL SETTING (PC D-SUB, PC RGB)	PXSL	WR	0	0	768) 1366 x 768	
				1	1	768) 1360 x 768	
				2	2	768) 1280 x 768	
				3	3	768) 1024 x 768	
				5	5	480) 848 x 480	
				6	6	480) 640 x 480	
				7	7	1050) 1680 x 1050	
				8	8	1050) 1400 x 1050	
				9	9	768) AUTO	○ ○
				10	10	480) AUTO	
INPUT RESOLUTION (AV)	RESOLUTION CHECK	RESO	R	-	-	480i, 480p, 1080i, 720p, 1080p, VGA, etc.	-
ZOOM2 SPECIAL SETTING (PC D-SUB, PC RGB)	Z2SP	WR	0-1	0-1	0: OFF, 1: ON	○	
SCAN MODE	SCAN	WR	0-2	0-2	0: MODE1, 1: MODE2, 2: MODE3 (When the input mode is AV)	○	
POWER MANAGEMENT (PC)	PMNG	WR	0-1	0-1	0: OFF, 1: ON	○	
POWER MANAGEMENT (AV)	PMAN	WR	0-1	0-1	0: OFF, 1: ON	○	
COLOR SYSTEM	CSYS	WR	0-5	0-5	0: AUTO, 1: PAL, 2: PAL-60, 3: SECAM, 4: NTSC3.58, 5: NTSC4.43	○ ○ ○	
AUDIO OUTPUT(RCA)	AOUT	WR	0-1	0-1	0: VARIABLE, 1: FIXED	○ ○ -	
AUDIO OUTPUT(RCA) When the PN-ZB02 (optional) is attached	AOUT	WR	0-2	0-2	0: VARIABLE1, 1: FIXED, 2: VARIABLE2	○ - ○	
AUDIO LEVEL(STEREO MINI)	AIVP	WR	0-1	0-1	0: 1.0Vrms, 1: 0.5Vrms	○	
SELF ADJUST	AADJ	WR	0-1	0-1	0: OFF, 1: ON	○	
AUTO INPUT CHANGE	AINC	WR	0-1	0-1	0: OFF, 1: ON	○	○ ○
FAN SPEED	FCTL	WR	0-4	0-4	0: AUTO, 1-4: SPEED 1-4	○	

Controlling the Monitor with a PC (RS-232C)

MULTI menu

Function	Command	Direction	Parameter	Reply	Control/Response contents	*1	*2		
						(A)	(B)		
ENLARGE	ENLG	WR	0-1	0-1	0: OFF, 1: ON				
ENLARGE MODE	EMAG	WR	0-4	0-4	0: OFF, 1: 2 x 2, 2: 3 x 3, 3: 4 x 4, 4: 5 x 5				
	EMHV	WR	11-55	11-55	1 x 1 (OFF) to 5 x 5 ("m x n" is expressed as "mn", where m and n are the numbers of monitors specified for the longest direction and the shortest direction respectively.)				
IMAGE POSITION (M x N)	EPHV	WR	11-55	11-55	Specifies values in the order of IMAGE POSITION IN LONGEST/ SHORTEST DIRECTION.				
IMAGE POSITION (2 x 2)	EPOS	WR	0-3	0-3	See the description below.				
IMAGE POSITION (3 x 3)	EPOS	WR	0-8	0-8					
IMAGE POSITION (4 x 4)	EPOS	WR	0-15	0-15					
IMAGE POSITION (5 x 5)	EPOS	WR	0-24	0-24					
ENLARGED SCREEN POSITIONING	THE LONGEST DIRECTION	EPSH	WR	-999-999		-999-999	The setting range depends on the ENLARGE MODE setting and the IMAGE POSITION.	-	O
	THE SHORTEST DIRECTION	EPSV	WR	-999-999	-999-999				
BEZEL ADJUST	BZCO	WR	0-1	0-1	0: OFF, 1: ON				
BEZEL ADJUST	TOP	BZCT	WR	0-1	0-1	0: OFF, 1: ON			
	BOTTOM	BZCB	WR	0-1	0-1	0: OFF, 1: ON			
	RIGHT	BZCR	WR	0-1	0-1	0: OFF, 1: ON			
	LEFT	BZCL	WR	0-1	0-1	0: OFF, 1: ON			
BEZEL WIDTH	TOP	BZWT	WR	0-100	0-100				
	BOTTOM	BZWB	WR	0-100	0-100				
	RIGHT	BZWR	WR	0-100	0-100				
	LEFT	BZWL	WR	0-100	0-100				
ENLARGE/IMAGE POSITION SETTING	ESTG	WR	XXYY	XXYY	XX: ENLARGE MODE (Same as EMAG), YY: IMAGE POSITION (Same as EPOS)				
	ESHV	WR	XXYY	XXYY	XX: ENLARGE MODE (Same as EMHV), YY: IMAGE POSITION (Same as EPHV)				

• IMAGE POSITION (EPOS) setting
In landscape orientation

2 x 2

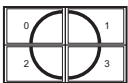

3 x 3

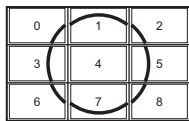

4 x 4

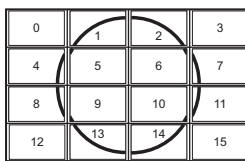

5 x 5

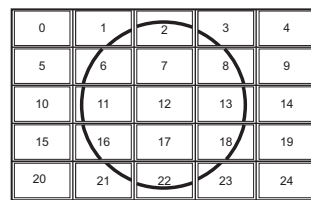

In portrait orientation

2 x 2



3 x 3

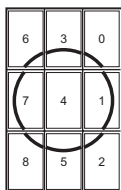

4 x 4

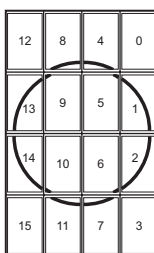

5 x 5

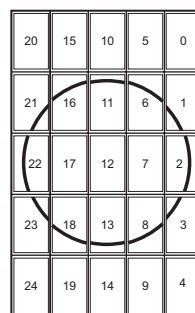

Controlling the Monitor with a PC (RS-232C)

PIP/PbyP menu

Function	Command	Direction	Parameter	Reply	Control/Response contents	*1	*2		
						(A)	(B)		
PIP MODES	MWIN	WR	0-3	0-3	0: OFF, 1: PIP, 2: PbyP, 3: PbyP2	○			
PIP SIZE	MPSZ	WR	1-64	1-64		○			
PIP POS	MHPS	W	0-100			○			
						R	0-100		
PIP POS	MVPS	W	0-100			○			
						R	0-100		
PIP POS LD+SD BATCH	MPOS	W	0-100,0-100		Specify the position in MPOSxxxxyy format. (xxx: Longer side, yyy: Shorter side position)	○			
						R	0-100,0-100	Returns a response in (xxx,yyy) format. (xxx: Longer side, yyy: Shorter side position)	○
PIP BLEND	MWBL	WR	0-15	0-15		○			
PIP SOURCE	MWIP	WR		1	1	PC DVI-D		-	○
				2	2	PC D-SUB		○	○
				3	3	AV COMPONENT (BNC)/AV COMPONENT (D-SUB)		○	○
				4	4	AV VIDEO (BNC)/AV VIDEO (D-SUB)		○	○
				6	6	PC RGB	○	-	○
				7	7	AV DVI-D		-	○
				8	8	AV S-VIDEO		-	○
				9	9	AV HDMI		○	○
				10	10	PC HDMI		○	○
				SOUND CHANGE	MWAD	WR	1-2	1-2	1: MAIN, 2: SUB
MAIN POS (Main screen)	MWPP	WR	0-1	0-1	0: POS1, 1: POS2	○			
PbyP2 POS (Sub screen)	MW2P	WR	0-2	0-2	0: POS1, 1: POS2, 2: POS3	○	○	○	
AUTO OFF	MOFF	WR	0-1	0-1	0: MANUAL, 1: AUTO	○			

Initialization/Functional Restriction Setting (FUNCTION) menu

Function	Command	Direction	Parameter	Reply	Control/Response contents	*1	*2	
						(A)	(B)	
ALL RESET	RSET	W	0		0: ALL RESET	-	○	-
			0-1		0: ALL RESET 1, 1: ALL RESET 2	-	-	○
ADJUSTMENT LOCK	ALCK	WR	0-2	0-2	0: OFF, 1:ON1, 2:ON2	○		
ADJUSTMENT LOCK TARGET	ALTG	WR	0-2	0-2	0: REMOTE CONTROL, 1: MONITOR BUTTONS, 2: BOTH	○		
OSD DISPLAY	LOSD	WR	0-2	0-2	0: ON1, 1: OFF, 2: ON2	○		
LED	OFLD	WR	0-1	0-1	0: ON, 1: OFF "ERR" when LOW POWER is selected for STANDBY MODE.	○	○	○
TEMPERATURE ALERT	TALT	WR	0-2	0-2	0: OFF, 1: OSD & LED, 2: LED	○		
STATUS ALERT	SALT	WR	0-2	0-2	0: OFF, 1: OSD & LED, 2: LED	○		
POWER BUTTON	PBTN	WR	0-1	0-1	0: MONITOR, 1: CONTROLLER	○		
CONTROLLER INPUT	PCIP	WR	0-2	0-2	0: D-SUB, 1: HDMI ("ERR" when MONITOR is selected for POWER BUTTON.)	○	○	○
					2: DVI-D ("ERR" when MONITOR is selected for POWER BUTTON.)	○	-	○

Controlling the Monitor with a PC (RS-232C)

Others

Function	Command	Direction	Parameter	Reply	Control/Response contents	*1	*2	
						(A)	(B)	(B)
SCREEN SIZE (PC)	WIDE	WR	1-5	1-5	1: WIDE, 2: NORMAL, 3: Dot by Dot, 4: ZOOM1, 5: ZOOM2	○		
SCREEN SIZE (AV)	WIDE	WR	1-5	1-5	1: WIDE, 2: ZOOM1, 3: ZOOM2, 4: NORMAL, 5: Dot by Dot	○		
VOLUME	VOLM	WR	0-31	0-31		○		
MUTE	MUTE	WR	0-1	0-1	0: OFF, 1: ON	-		
INFORMATION	MODEL	INF1		Value		●		
	SERIAL NO	SRNO		Value				
BRIGHT	VLMP	WR	0-31	0-31		○		
TEMPERATURE SENSOR	DSTA	R		0	Internal temperature normal			
				1	Internal temperature abnormal (Standby mode)			
				2	Internal temperature abnormal (Temperature is normal now, but it was abnormal during operation.)	●		
				3	Internal temperature abnormal (Brightness of the backlight decreases.)			
				4	Temperature sensor abnormal		○	○
TEMPERATURE ACQUISITION	ERRT	R		Value	Temperature at temperature sensors 1 through 6 are returned in the following forms: [Sensor 1], [Sensor 2], [Sensor 3], [Sensor 4], [Sensor 5], [Sensor 6] Indicates a temperature sensor abnormality when "126" is returned.	○		
CAUSE OF LAST STANDBY MODE	STCA	W	0		Initialization			
		R	0	No detectable error has occurred				
			1	Standby mode by POWER button				
			2	Main power off by the main power switch				
			3	Standby mode by RS-232C or LAN	●			
			4	Waiting mode by No Signal				
			6	Standby mode by abnormal temperature				
			8	Standby mode by SCHEDULE setting				
			20	Standby mode by OFF IF NO OPERATION setting				

Commands for setting of the GAMMA user data

Function	Command	Direction	Parameter	Reply	Control/Response contents	*1	*2	
						(A)	(B)	(B)
RED GAMMA DATA TRANSFER	UGRW	W	aa: 01-16		aa: Block number			
GREEN GAMMA DATA TRANSFER	UGGW	W	cc: 00-FF		xxxx: 32 pieces of user data			
BLUE GAMMA DATA TRANSFER	UGBW	W			cc: Checksum (ASCII data) of the block number and user data			
RED GAMMA DATA READ	UGRR	W	1-16	xxxx ... xxxx	xxxx: User data of 32 pieces	○	○	○
GREEN GAMMA DATA READ	UGGR	W	1-16	(xxxx: 32 pieces)				
BLUE GAMMA DATA READ	UGBR	W	1-16	xxxx: 0000-1023				
USER DATA INITIALIZE	UGRS	W	0		Initialize the user data.			
USER DATA SAVE	UGSV	W	0		Save the user data in the monitor.			

Controlling the Monitor with a PC (LAN)

When the PN-ZB02 (optional) is attached, your monitor can be connected to a LAN allowing you to control it from a PC on the LAN.

You can also configure the monitor to send e-mail notification when it has a problem.

The connection requires a commercially available LAN cable (UTP cable, Category 5, straight through).

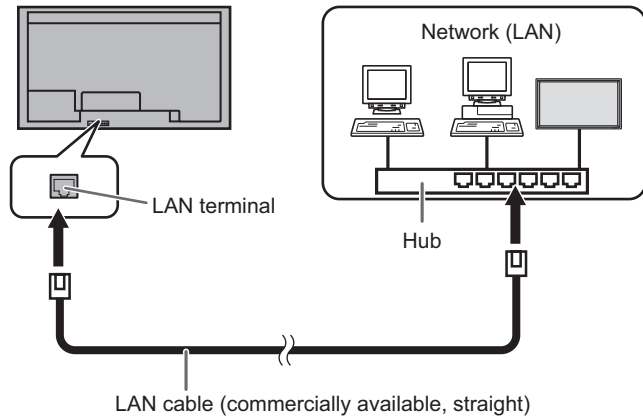

TIPS

- You must assign an IP address to the monitor by following the procedures in "Settings to connect to a LAN". (See the description on the right.)
- Your PC must be installed with Internet Explorer (version 7.0 or later).
- To control the monitor via LAN, set RS-232C/LAN SELECT to LAN. (See page 24.)
- You cannot use RS-232C and LAN control simultaneously.

Initializing personal information

- When the PN-ZB02 (optional) is attached, personal information such as e-mail addresses can be registered in the monitor. Before transferring or disposing of the monitor, initialize all settings by selecting ALL RESET 1. (See page 31.) Note that ALL RESET 2 will not initialize e-mail addresses and other settings.

Settings to connect to a LAN

Set the monitor's IP address and subnet mask to match the settings of your LAN.

These settings can be made on either the monitor or a PC connected to the monitor.

The settings depend on the configuration of your LAN. Ask your LAN administrator for details.

■ To set on the monitor

Set RS-232C/LAN SELECT on the SETUP menu to LAN, and then set the LAN SETUP options. (See pages 24 and 25.)

After setting each item, select SET and press .

DHCP CLIENT

If your LAN has a DHCP server and you wish to obtain an address automatically, change this setting to ON.

To set the address manually, set this to OFF.

IP ADDRESS

If the DHCP CLIENT is set to OFF, specify an IP address.

Press or to select items, and press or to change the values.

SUBNET MASK

If the DHCP CLIENT is set to OFF, specify the subnet mask.

Press or to select items, and press or to change the values.

DEFAULT GATEWAY

If the DHCP CLIENT is set to OFF, specify the default gateway.

If you are not using a gateway, specify "0.0.0.0".

Press or to select items, and press or to change the values.

RESET

Resets the values of the LAN settings to the factory preset values.

Select ON and then press .

TIPS

- When manually setting the IP address, the IP address for secondary monitors connected by RS-232C can be automatically allocated. (See page 25.)

Controlling the Monitor with a PC (LAN)

■ To set from a PC

When the monitor is connected to a PC, LAN settings can be configured via PC.

Set up process

- (1) Connect your monitor to a PC
- (2) Specify the PC's IP address
- (3) Configure the monitor's LAN settings

(1) Connecting your monitor to a PC

Connect a commercially available crossover LAN cable (UPT cable, Category 5) to the LAN port on the PC and this monitor.

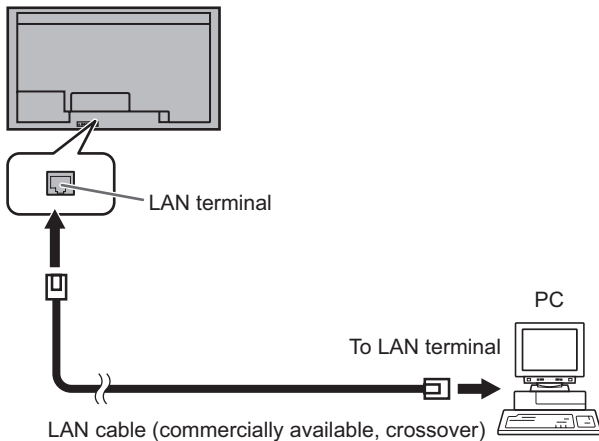

(2) Specifying the PC's IP address

To configure the monitor's LAN settings, you must temporarily change the settings on the PC.

This explanation is based on Windows 7.

1. Log on to the PC with an administrator account.
 2. Click [Start], and then click "Control Panel".
 3. Click "View network status and tasks" in "Network and Internet".
 - In "Classic View", click "Network and Sharing Center".
 4. Click "Local Area Connection" and then "Properties".
 5. Click "Internet Protocol Version 4 (TCP/IPv4)" and then "Properties".
 6. Make a note of the current IP address, subnet mask, and default gateway settings.
- Make sure you write this information now as you will be changing the IP address, subnet mask, and default gateway settings back to these settings afterwards.

7. Temporarily change the IP address and subnet mask. To access the monitor as it is shipped from the factory, set as follows.

- IP Address : 192.168.150.1
- Subnet Mask : 255.255.255.0
- Default Gateway : (leave blank)

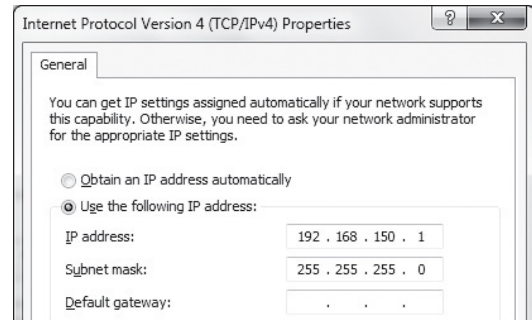

8. Click [OK] and then reboot the PC.

TIPS

- This monitor is factory preset as shown below. (When DHCP CLIENT is set to OFF)
IP Address : 192.168.150.2
Subnet Mask : 255.255.255.0
Default Gateway : 0.0.0.0

(3) Configuring the monitor's LAN settings

Access the monitor using Internet Explorer.

Controlling the monitor

1. Turn the power ON to the monitor.
2. Set RS-232C/LAN SELECT on the SETUP menu to LAN.
3. Set DHCP CLIENT to OFF in LAN SETUP on the SETUP menu.

PC operation

4. Launch Internet Explorer, in the "Address" box type "http://192.168.150.2/" and press the Enter key.



- You will be prompted to enter a user name and password.
5. Leave the user name and password boxes blank and click [OK].
 6. Click on "LAN SETUP" under NETWORK.

INFORMATION		PN: XXXXX	
CONTROL		PC: 00000	
ADJUSTMENT		1900a1000	
- SCREEN	MODEL	12345678	
- PICTURE	S/N		
- PICTURE(ADVANCED)	INSTALLATION INFORMATION		
- AUDIO	NAME		
- SETUP	LOCATION		
- OPTION	MONITOR POWER	ON	
- SCREENSAVE	DATE/TIME		
- MENU	INPUT MODE	PC (DVI-D)	
- PICTURE	SIZE	2000G	
- FUNCTION	COLOR MODE	sRGB	
NETWORK		BRIGHT	31
- LAN SETUP	VOLUME	12	
- DHCP	ID No.	1	
- GENERAL	STATUS	0000-0000-0000-0000	
MAIL		URL INFORMATION	STATUS[0000]
- ORIGINATOR	RS-232C/LAN SELECT	LAN	
- RECIPIENT	DHCP CLIENT	OFF	
- PERIODICAL	IP ADDRESS	192.168.150.2	
SNMP		SUBNET MASK	255.255.255.0
- GENERAL	DEFAULT GATEWAY	0.0.0.0	
- TRAP	MONITOR NAME	PN-XXXXX	
SERVICE & SUPPORT		DATA PORT	10000
- URL INFORMATION	MAC ADDRESS	XX-XX-XX-XX-XX-XX	
		REMOTE CONTROL SENSOR BOX	CONNECTED

7. Specify the “DHCP CLIENT”, “IP ADDRESS”, etc.

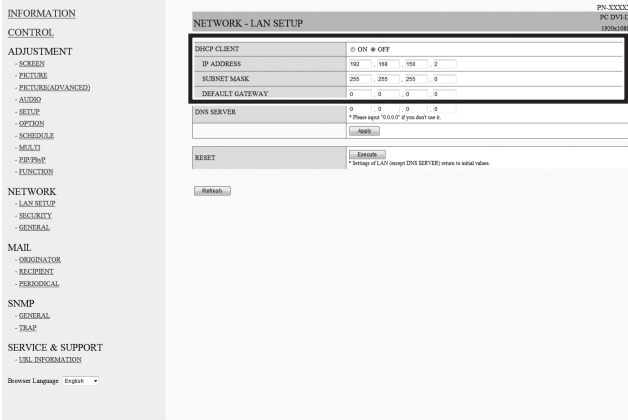

DHCP CLIENT

If your LAN has a DHCP server and you wish to obtain an address automatically, change this setting to ON. To set the address manually, set this to OFF.

IP ADDRESS

If the DHCP CLIENT is set to OFF, specify an IP address.

SUBNET MASK

If the DHCP CLIENT is set to OFF, specify the subnet mask.

DEFAULT GATEWAY

If the DHCP CLIENT is set to OFF, specify the default gateway. If you are not using a default gateway, specify “0.0.0.0”.

8. When the setting is changed, click [Apply].
9. Check the message and click [OK].
10. Exit Internet Explorer.
11. Restore the PC's IP address jotted in Step 6, “(2) Specifying the PC's IP address”.
12. Connect the monitor and the PC to the LAN.

Caution

- Wait 10 seconds after clicking [OK] before proceeding.
- When operating using the remote control unit or similar, click [Refresh].

TIPS

- When manually setting the IP address, the IP address for secondary monitors connected by RS-232C can be automatically allocated. (See page 25.)

Controlling with a PC

Basic operation

You use Internet Explorer on a PC on the LAN to control the monitor.

1. Launch Internet Explorer on the PC.
2. In the “Address” box, type “http://” followed by your monitor's IP address followed by “/”, then press the Enter key. You can confirm the IP address with the DISPLAY function.



When prompted to enter a user name and password, type the user name and password that you specified in the security settings (see page 49), and click [OK].

If you did not make any security settings, leave the spaces blank and click on [OK].

3. You can check, control, and change the monitor's status and settings by clicking the menu items on the left side of the screen.

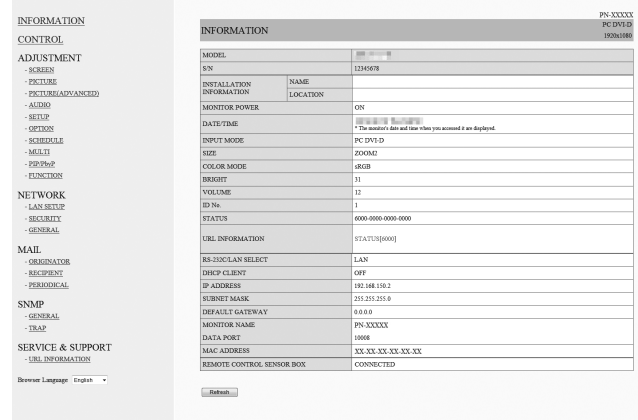

- If you see an [Apply] button next to a setting, click it after you change that setting.

TIPS

- See pages 48 to 52 for details on each setting.
- If you click [Refresh] before the screen finishes updating the current display, the “Server Busy Error” will appear. Wait for a moment before operating your monitor again.
- You cannot operate the monitor while it is warming up.
- If DHCP CLIENT is set to ON, press ^{DISPLAY} on the remote control unit two times and then check the monitor's IP address.

Controlling the Monitor with a PC (LAN)

■ INFORMATION

Information about this monitor appears.

INFORMATION		PN-XXXXX
CONTROL		PC DVI-D 1920x1080
ADJUSTMENT		
- SCREEN		
- PICTURE		
- PICTURE(ADVANCED)		
- AUDIO		
- SETUP		
- OPTION		
- SCHEDULE		
- MULTI		
- PIP/PbP		
- FUNCTION		
NETWORK		
- LAN SETUP		
- SECURITY		
- GENERAL		
MAIL		
- ORIGINATOR		
- RECIPIENT		
- PERIODICAL		
SNMP		
- GENERAL		
- TRAP		
SERVICE & SUPPORT		
- URL INFORMATION		
Reverse Language: English		

INFORMATION		PN-XXXXX
CONTROL		PC DVI-D 1920x1080
MODEL	1224678	
S/N		
INSTALLATION INFORMATION	NAME	
	LOCATION	
MONITOR POWER	ON	
DATE/TIME	12:00:00	
INPUT MODE	PC DVI-D	* The monitor is dim and tone when you accessed it on display.
SIZE	200M2	
COLOR MODE	sRGB	
BRIGHT	11	
VOLUME	12	
ID No.	1	
STATUS	0000-0000-0000-0000	
URL INFORMATION	STATUS[0000]	
RS-232C/LAN SELECT	LAN	
DHCP CLIENT	OFF	
IP ADDRESS	192.168.150.2	
SUBNET MASK	255.255.255.0	
DEFAULT GATEWAY	0.0.0.0	
MONITOR NAME	PN-XXXXX	
DATA PORT	10008	
MAC ADDRESS	XX.XX.XX.XX.XX.XX	
REMOTE CONTROL SENSOR BOX	CONNECTED	
[Refresh]		

■ CONTROL

You can control the operations corresponding to the buttons (POWER INPUT SIZE) on the remote control unit. (See pages 18 and 19.)

INFORMATION		PN-XXXXX
CONTROL		PC DVI-D 1920x1080
ADJUSTMENT		
- SCREEN		
- PICTURE		
- PICTURE(ADVANCED)		
- AUDIO		
- SETUP		
- OPTION		
- SCHEDULE		
- MULTI		
- PIP/PbP		
- FUNCTION		
NETWORK		
- LAN SETUP		
- SECURITY		
- GENERAL		
MAIL		
- ORIGINATOR		
- RECIPIENT		
- PERIODICAL		
SNMP		
- GENERAL		
- TRAP		
SERVICE & SUPPORT		
- URL INFORMATION		
Reverse Language: English		

CONTROL		PN-XXXXX
CONTROL		PC DVI-D 1920x1080
MONITOR POWER	ON OFF	
INPUT MODE	PC DVI-D	
SIZE	200M2	
COLOR MODE	sRGB	
BRIGHT	(Cannot operate now)	
VOLUME	12	
MUTE	ON OFF	
REMOTE CONTROL MODE	ALL WORKFLOWS	
* Only the operations below are applied to all monitors. * Power on/off, setup mode change, display of product information		
SENDING ITEM	ON OFF	
* REMOTE CONTROL MODE setting is for operations by using REMOTE CONTROL SENSOR BOX or monitor's buttons.		
[Refresh]		
* Please click [Refresh] button to check the setting of each item after you change it.		

TIPS

- In standby mode, Power ON is the operation available.

■ ADJUSTMENT

You can adjust these settings which are also available on the monitor's menu.

- SCREEN (See page 23.)
- PICTURE (See page 23.)
- PICTURE (ADVANCED) (See page 30.)
- AUDIO (See page 24.)
- SETUP (See page 24.)
- OPTION (See page 26.)
- SCHEDULE (See page 29.)
- MULTI (See page 27.)
- PIP/PbP (See page 27.)
- FUNCTION (See page 31.)

INFORMATION		PN-XXXXX
CONTROL		PC DVI-D 1920x1080
ADJUSTMENT		
- SCREEN		
- PICTURE		
- PICTURE(ADVANCED)		
- AUDIO		
- SETUP		
- OPTION		
- SCHEDULE		
- MULTI		
- PIP/PbP		
- FUNCTION		
NETWORK		
- LAN SETUP		
- SECURITY		
- GENERAL		
MAIL		
- ORIGINATOR		
- RECIPIENT		
- PERIODICAL		
SNMP		
- GENERAL		
- TRAP		
SERVICE & SUPPORT		
- URL INFORMATION		
Reverse Language: English		

ADJUSTMENT - SCREEN		PN-XXXXX
CONTROL		PC DVI-D 1920x1080
AUTO	(Cannot operate now)	
CLOCK	(Cannot operate now)	
PHASE	(Cannot operate now)	
H-POS	50	
V-POS	50	
H-SIZE	50	
V-SIZE	50	
H-RESOLUTION	(Cannot operate now)	
V-RESOLUTION	(Cannot operate now)	
RESET	[Refresh]	
* Setting of the SCREEN adjustment return to initial value.		
[Refresh]		
* Please click [Refresh] button to check the setting of each item after you change it.		

TIPS

- After changing DISPLAY COLOR PATTERN to OFF, click [Refresh] to correctly retrieve the status of the monitor.

■ NETWORK (LAN SETUP)

This screen allows you to set the settings necessary when the monitor is connected to a LAN.

DHCP CLIENT

If your LAN has a DHCP server and you wish to obtain an address automatically, change this setting to ON. To set the address manually, set this to OFF.

IP ADDRESS

If the DHCP CLIENT is set to OFF, specify an IP address.

SUBNET MASK

If the DHCP CLIENT is set to OFF, specify the subnet mask.

DEFAULT GATEWAY

If the DHCP CLIENT is set to OFF, specify the default gateway. If you are not using a default gateway, specify "0.0.0.0".

DNS SERVER

Specify the DNS server address. If you are not using a DNS server, specify "0.0.0.0".

RESET

Clicking [Execute] returns all of the LAN SETUP settings to the factory-preset values except for the DNS SERVER setting.

TIPS

- When manually setting the IP address, the IP address for secondary monitors connected by RS-232C can be automatically allocated. (See page 25.)

■ NETWORK (SECURITY)

This screen allows you to specify the security-related settings.

USER NAME / PASSWORD

Sets up a user name and password to restrict access to this monitor. After entering a user name and password, click [Apply].

ACCEPT IP ADDRESS

You can limit access to this monitor by registering IP addresses of PCs that should have access. To limit access, specify the option "From only specific IP addresses". Otherwise, to allow access from any PC, specify "All IP Addresses".

IP ADDRESS 1 to 3

If "ACCEPT IP ADDRESS" is set to "From only specific IP addresses", enter the IP addresses that you want to allow.

TIPS

- The USER NAME and PASSWORD can be up to 8 alphanumeric characters or symbols.
- To cancel the user name and/or password after it has been set, make the box empty and click [Apply].

Controlling the Monitor with a PC (LAN)

■ NETWORK (GENERAL)

This screen allows you to specify the general LAN settings.

NETWORK - GENERAL	
MONITOR NAME	PN-XXXXX *MAX 16 characters
AUTO LOGOUT TIME	5 minutes * Range 1 to 65535 If you set 0, this function is disabled
DATA PORT	1026 * Range 1025 to 65535
SEARCH PORT	5000 * Range 1025 to 65535
INSTALLATION INFORMATION	NAME *MAX 16 characters
	LOCATION *MAX 100 characters

MONITOR NAME

Specify a name for this monitor as it should appear on the Internet Explorer screen.

AUTO LOGOUT TIME

Specify the time (in minutes) to elapse before automatically disconnecting this monitor from the network.
Specify in minutes from 1 to 65535. A value of '0' will disable this function.

DATA PORT

Specify the TCP port number to use for exchanging data with the monitor.
Specify a value from 1025 to 65535.

SEARCH PORT

Specify the port number to use when searching for this monitor.
Specify a value from 1025 to 65535.

INSTALLATION INFORMATION (NAME/LOCATION)

Specify the information to display for this monitor in the Internet Explorer window.

TIPS

- The MONITOR NAME can be up to 16 alphanumeric characters or symbols.
- Enter up to 50 characters in the NAME field in the INSTALLATION INFORMATION.
- Enter up to 100 characters in the LOCATION field in the INSTALLATION INFORMATION.

■ MAIL (ORIGINATOR)

This screen allows you to configure the e-mail sent periodically or when the monitor has an error.
The settings depend on the configuration of your LAN. Ask your LAN administrator for details.

MAIL - ORIGINATOR	
SMTP SERVER	*MAX 64 characters
ORIGINATOR E-MAIL ADDRESS	*MAX 64 characters
ORIGINATOR NAME	*MAX 64 characters
AUTHENTICATION	* NONE @ POP before SMTP
POP SERVER	Do not need this setting *MAX 64 characters
ACCOUNT NAME	Do not need this setting *MAX 64 characters
PASSWORD	*MAX 64 characters

SMTP SERVER

Specify the SMTP server address for sending e-mail.
* When using a domain name, make sure to specify the DNS SERVER as well. (See page 49.)

ORIGINATOR E-MAIL ADDRESS

Specify the e-mail address for this monitor.
This address becomes the e-mail address of the originator.

ORIGINATOR NAME

Specify the name for the originator.
This name appears in the "Originator Name" field of the e-mail.

AUTHENTICATION

Specify the authentication method to use when sending e-mail.

POP SERVER

If the "AUTHENTICATION" method is "POP before SMTP", specify the POP server address.

ACCOUNT NAME / PASSWORD

If the "AUTHENTICATION" method is "POP before SMTP", specify the account name and password to connect to the POP server.

TIPS

- You can enter up to 64 alphanumeric characters or symbols for the ORIGINATOR E-MAIL ADDRESS, ORIGINATOR NAME, ACCOUNT NAME, and PASSWORD.
- The SMTP SERVER and POP SERVER can be up to 64 characters.
The following characters can be used: a-z, A-Z, 0-9, - , .

MAIL (RECIPIENT)

This screen allows you to specify the recipients of the e-mail sent periodically or when the monitor has an error.

No.	RECIPIENT E-MAIL ADDRESSES <small>*MAX 64 characters</small>	CONDITION			CONFIRMATION
		PERIODICAL	TEMPERATURE	HARDWARE	
1		<input type="checkbox"/>	<input type="checkbox"/>	<input type="checkbox"/>	Test
2		<input type="checkbox"/>	<input type="checkbox"/>	<input type="checkbox"/>	Test
3		<input type="checkbox"/>	<input type="checkbox"/>	<input type="checkbox"/>	Test

Attach the log file to a TEMPERATURE/HARDWARE error e-mail
*attach no log file to a PERIODICAL report e-mail.

Apply

Refresh

RECIPIENT E-MAIL ADDRESSES

Specify the e-mail addresses to send error notification e-mail to.

CONDITION

Specify the conditions to send mails.
When you check PERIODICAL, specify the date and time to send the mails in the PERIODICAL setting.

CONFIRMATION

Sends test e-mail.
This allows you to confirm that the e-mail settings are configured properly.

Attach the log file to a TEMPERATURE/HARDWARE error e-mail.

When this option is checked, a log is added to the mail which notifies a temperature or status error.

TIPS

- The RECIPIENT E-MAIL ADDRESSES can be up to 64 alphanumeric characters or symbols.

MAIL (PERIODICAL)

When PERIODICAL for CONDITION of MAIL (RECIPIENT) is checked, set the date and time to send the mail.

DAY OF THE WEEK: SUN MON TUE WED THU FRI SAT
*Please check the day of the week sending a mail.

TIME: 1, 2, 3, 4 (AM/PM dropdowns)
*Time sending an e-mail.

Apply

Refresh

DAY OF THE WEEK

Specify the day of the week to send the periodical mails.

TIME

Specify the time of the day to send the periodical mails.

! Caution

- Do not turn off the main power when you set to send the periodical mails.
- Specify the correct date and time. (See page 26.)
If the date and time settings are incorrect, the periodical mail is not sent properly.
- Regularly confirm that the specified date and time is correct.
- When LOW POWER is selected for STANDBY MODE, periodical mails will not be sent in standby mode.

Controlling the Monitor with a PC (LAN)

■SNMP

You can configure settings related to SNMP.

INFORMATION
CONTROL
ADJUSTMENT
- SCREEN
- PICTURE
- PICTURE(ADVANCED)
- AUDIO
- SETUP
- OPTION
- SCHEDULE
- MULTI
- PIP/PIP
- FUNCTION
NETWORK
- LAN SETUP
- SECURITY
- GENERAL
MAIL
- ORIGINATOR
- RECIPIENT
- PERIODICAL
SNMP
- GENERAL
- TRAP
SERVICE & SUPPORT
- URL INFORMATION
Browser Language: English

PN-XXXXX
PC-DV1-D
1920x1080

SNMP - GENERAL

SNMP SETTING ON OFF

VERSION SNMPv1 SNMPv2 SNMPv3

COMMUNITY NAME 1 *MAX 16 characters
 Read/Write Read

COMMUNITY NAME 2 *MAX 16 characters
 Read/Write Read

COMMUNITY NAME 3 *MAX 16 characters
 Read/Write Read

USER 1
USER NAME *MAX 16 characters
AUTHENTICATION PASSWORD *MAX 16 characters
ENCRYPTION PASSWORD *MAX 16 characters
SECURITY LEVEL: No Auth, No Encryption SEAL MD5
DIGEST ALGORITHM: SHA1 MD5

USER 2
USER NAME *MAX 16 characters
AUTHENTICATION PASSWORD *MAX 16 characters
ENCRYPTION PASSWORD *MAX 16 characters
SECURITY LEVEL: No Auth, No Encryption SEAL MD5
DIGEST ALGORITHM: SHA1 MD5

USER 3
USER NAME *MAX 16 characters
AUTHENTICATION PASSWORD *MAX 16 characters
ENCRYPTION PASSWORD *MAX 16 characters
SECURITY LEVEL: No Auth, No Encryption SEAL MD5
DIGEST ALGORITHM: SHA1 MD5

Switch the main power off and on to be effective.
25s (The screen returns to off and on main power)
Switch the main power of monitor off and on now.

Apply Refresh

INFORMATION
CONTROL
ADJUSTMENT
- SCREEN
- PICTURE
- PICTURE(ADVANCED)
- AUDIO
- SETUP
- OPTION
- SCHEDULE
- MULTI
- PIP/PIP
- FUNCTION
NETWORK
- LAN SETUP
- SECURITY
- GENERAL
MAIL
- ORIGINATOR
- RECIPIENT
- PERIODICAL
SNMP
- GENERAL
- TRAP
SERVICE & SUPPORT
- URL INFORMATION
Browser Language: English

PN-XXXXX
PC-DV1-D
1920x1080

SNMP - TRAP

TRAP SETTING ON OFF

TRAP SETTING OF AUTHENTICATION ERROR ON OFF

TRAP ADDRESS & PORT

TRAP #	ADDRESS	0	0	0	0	0	PORT	0
TRAP 1	ADDRESS	0	0	0	0	0	PORT	0
TRAP 2	ADDRESS	0	0	0	0	0	PORT	0
TRAP 3	ADDRESS	0	0	0	0	0	PORT	0

Apply Refresh

SNMP SETTING

Set whether to enable or disable SNMP.

VERSION

Set the version of the SNMP to be supported.

COMMUNITY NAME 1 to 3

Set the name of the community required for the access.

USER 1 to 3

Set the user name, password, authentication method and other options required for access.

TRAP SETTING

Set whether to enable or disable the trap function. When this function is enabled, a trap will be sent when the monitor is turned on.

TRAP SETTING OF AUTHENTICATION ERROR

Set whether the trap function sends a notification when authentication fails.

TRAP ADDRESS & PORT

Set the destination address and port number of the notification sent by the trap function.

! Caution

- After you set SNMP, click [Switch the main power of monitor off and on now.] or turn off the monitor and then turn it on again with the main power switch. When the monitor restarts, wait about 30 seconds and then start the next operation.
- If the IP address is changed while the SNMP function is operational, turn off the monitor and then turn it on again with the main power switch.

TIPS

- Depending on the SNMP settings, a short delay may occur before the SNMP is usable. (About 2 minutes)
- Up to 16 alphanumeric letters and symbols can be used for the community name, user name and password.

■SERVICE & SUPPORT (URL INFORMATION)

You can display a specific URL in the URL INFORMATION field on the INFORMATION screen when an error occurs in the monitor. (See page 48.)

INFORMATION
CONTROL
ADJUSTMENT
- SCREEN
- PICTURE
- PICTURE(ADVANCED)
- AUDIO
- SETUP
- OPTION
- SCHEDULE
- MULTI
- PIP/PIP
- FUNCTION
NETWORK
- LAN SETUP
- SECURITY
- GENERAL
MAIL
- ORIGINATOR
- RECIPIENT
- PERIODICAL
SNMP
- GENERAL
- TRAP
SERVICE & SUPPORT
- URL INFORMATION
Browser Language: English

PN-XXXXX
PC-DV1-D
1920x1080

SERVICE & SUPPORT - URL INFORMATION

URL INFORMATION *MAX 64 characters	CONDITION			CONFIRMATION Test
	ALWAYS	TEMPERATURE	HARDWARE	
	<input type="checkbox"/>	<input type="checkbox"/>	<input type="checkbox"/>	Test

Apply Refresh

URL INFORMATION

Enter the URL to display on the INFORMATION screen when an error occurs on the monitor.

Up to 64 alphanumeric characters or symbols can be used.

CONDITION

Specify the condition to display the URL.

CONFIRMATION

The home page of the specified URL is displayed.

You can check whether the URL you entered is correct.

TIPS

- It is also possible to specify the message text, such as the name of a contact or a telephone number, to be displayed instead of the linked URL.

Troubleshooting

If you are experiencing any problem with your display, before calling for service, please review the following troubleshooting tips.

There is no picture or sound.

- Is the power cord disconnected? (See page 15.)
- Is the main power switch off? (See page 17.)
- Is the monitor in standby mode (the power LED illuminating in orange)?
- Make sure correct input mode is selected. (See page 18.)
- If any external equipment is connected, make sure the equipment is operating (playing back).

Remote control does not work.

- Are the batteries inserted with polarity (+,-) aligned? (See page 15.)
- Are the batteries exhausted?
- Point the remote control unit toward the remote control sensor.
- Is the menu display hidden or is operation disabled? (See page 31.)
- Is the PN-ZR01 (optional) remote control sensor box disconnected?
- If the main unit is connected to multiple monitors, is the RS-232 cable disconnected? Has the ID No. been set?

Sound from left and right speakers is reversed.

Sound is heard from only one side.

- Are audio cables connected properly? (See pages 12 to 13.)
- Make sure audio cables for external speakers are connected properly: left and right cables may be reversed or one of the two cables may not be connected. (See page 13.)
- Check the setting of BALANCE for AUDIO menu. (See page 24.)

There is a picture but no sound.

- Is the sound muted?
- Make sure the volume is not set to minimum.
- Are audio cables connected properly?
- Is the setting of AUDIO SELECT on the OPTION menu correct? (See page 26.)

Unstable video.

- The signal may be incompatible.
- Try the automatic screen adjustment when the PC D-sub input terminal or PC RGB input terminals are used.

The video from the PC/AV HDMI input terminal does not appear properly.

- Is the setting for HDMI of INPUT SELECT on the OPTION menu correct? (See page 26.)
- Is the HDMI cable HDMI standard compliant? The monitor will not work with cables that are not standard compliant.
- Is the input signal compatible with this monitor? (See pages 57 to 58.)

The video from the PC/AV DVI-D input terminal does not appear properly.

- Is the setting for DVI of INPUT SELECT on the OPTION menu correct? (See page 26.)
- Is the input signal compatible with this monitor? (See pages 57 to 58.)
- Turn off the power to the connected equipment and then turn the power on again.
- If the monitors are connected in a daisy chain, turn off the power to all the monitors connected in a daisy chain and then turn the power on again.

The video from PC D-SUB, PC RGB, AV COMPONENT, or AV VIDEO does not appear correctly.

- Is the setting for BNC or D-SUB of INPUT SELECT on the OPTION menu correct? (See page 26.)
- Is the input signal compatible with this monitor? (See pages 57 to 58.)

Control buttons do not work.

There is no picture.

- Load noises from outside may be interfering with normal operation. Turn off the power and turn it on after waiting at least 5 seconds, and then check the operation.

The input mode changes automatically.

- When the AUTO INPUT CHANGE is ON and no signal is present in a selected input mode, the AUTO INPUT CHANGE automatically changes the selected mode to a mode where a video signal is present. The input mode may change in the following cases:
 - When a computer is in standby mode.
 - When video play is stopped with a playback device.

Power LED flashes red.

“STATUS [xxxx]” appears in the corner of the screen.

- Hardware has a problem. Turn off the monitor and request repair from your SHARP dealer. (When STATUS ALERT is set to OSD & LED. This varies depending on the setting.)

When “AUTO DIMMING” is displayed.

- When the internal temperature of the monitor rises excessively, the brightness of the backlight automatically decreases in order to prevent a further temperature rise. If you attempt to use  to adjust the brightness while the monitor is in this state, “AUTO DIMMING” is displayed and you cannot change the brightness.
- Remove the cause of the excessive temperature rise.

The monitor makes a cracking sound.

- You may occasionally hear a cracking sound from the monitor. This happens when the cabinet slightly expands and contracts according to change in temperature. This does not affect the monitor's performance.

Troubleshooting

The Power LED is flashing in red and green alternately. When “TEMPERATURE” is displayed in the corner of the screen.

- When the internal temperature of the monitor rises excessively, the brightness of the backlight decreases automatically in order to prevent high-temperature-related problems. When this occurs, “TEMPERATURE” is displayed on the screen and the Power LED flashes red and green alternately. (When TEMPERATURE ALERT is set to OSD & LED. This varies depending on the setting.)
- If the internal temperature rises further, the monitor automatically enters standby mode. (The Power LED continues flashing red and green alternately.)
- Remove the cause of the excessive temperature rise.
 - If the monitor enters standby mode due to a rise in temperature, to return to normal display, turn the power switch off and then back on again. The monitor, however, will enter standby mode again if the cause of the temperature rise is not eliminated.
 - Check whether the monitor is placed at a location where a quick rise in temperature is likely. Internal temperature rises quickly if the vents on the monitor are blocked.
 - Internal temperature rises quickly if dust accumulates inside the monitor or around the vents. Remove dust if possible. Ask SHARP dealer about removing internal dust.

Specifications

■PN-V602A Product Specifications

Model	PN-V602A			
LCD component	60" Class [60 inch (152.4cm) diagonal] TFT LCD			
Max. resolution (pixels)	1366 x 768			
Max. colors	Approx. 16.77 M colors			
Pixel pitch	0.973 mm (H) × 0.973 mm (V)			
Max. brightness (typical)	1500 cd/m ² *1			
Contrast ratio (typical)	1,000,000 : 1 (When LOCAL DIMMING is set to HIGH.) 5,000 : 1 (When LOCAL DIMMING is set to OFF.)			
Viewing angle	176° right/left/up/down (contrast ratio ≥ 10)			
Screen active area inch (mm)	52-5/8 x 29-7/16 (1328.8 x 747.1)			
Computer input signal	Digital (DVI 1.0 standard-compliant), Analog RGB (0.7 Vp-p) [75 Ω]			
Sync signal	Horizontal/vertical separate (TTL: positive/negative), Sync-on-green, Composite sync (TTL: positive/negative)			
Video color system	NTSC (3.58MHz)/NTSC (4.43MHz)/PAL/PAL-60/SECAM			
Plug and play	VESA DDC2B			
Power management	VESA DPMS, DVI DMPM			
Input terminals	PC/AV	Digital	HDMI x 1	
	PC	Analog	Mini D-sub 15 pin, 3 rows x 1	
	Audio		3.5 mm mini stereo jack x 1	
	Serial (RS-232C)		D-sub 9 pin x 1	
	When PN-ZB02 (optional) is attached	PC/AV	Digital	DVI-D 24 pin (HDCP compatible) x 1
		PC	Analog	BNC *2*3 x 1
		AV	Composite video	BNC x 1
			S-video	x 1
		Component	BNC (Y, Cb/Pb, Cr/Pr) *2 x 1	
	Audio		RCA pin (L/R) x 2	
Output terminals	Audio		RCA pin (L/R) x 1	
	Serial (RS-232C)		D-sub 9 pin x 1	
	When PN-ZB02 (optional) is attached	PC/AV	Digital	DVI-D 24 pin x 1
		External speaker		10 W + 10 W [6 Ω]
LAN terminal [When PN-ZB02 (optional) is attached]	10 BASE-T/100 BASE-TX			
Power requirement	AC 100 V - 240 V, 5.7 A, 50/60 Hz			
Operating temperature *4	32°F to 104°F (0°C to 40°C)			
Operating humidity	20% to 80% (no condensation)			
Power consumption (maximum *5 / input signal waiting mode *6 / standby mode *7)	510 W / 1.0 W / 1.0 W			
Power consumption [PN-ZB02 (optional)]	530 W			
Dimensions (excluding protrusions) inch (mm)	Approx. 52-5/8 (W) x 5-7/8 (D) x 29-11/16 (H) (1335.9 x 149.3 x 754.2)			
Weight lbs. (kg)	Approx. 97.0 (44)			
Weight [PN-ZB02 (optional)] lbs. (kg)	Approx. 1.102 (0.5)			

*1 Brightness will depend on input mode and other picture settings. Brightness level will decrease over time. Due to the nature of the equipment, it is not possible to precisely maintain a constant level of brightness.

*2 Cannot be used simultaneously.

*3 Does not support plug and play.

*4 Temperature condition may change when using the display together with the optional equipments recommended by SHARP. In such cases, please check the temperature condition specified by the optional equipments.

*5 When LOCAL DIMMING is set to OFF. When LOCAL DIMMING is set to HIGH: 270 W *8.

*6 When AUTO INPUT CHANGE is set to OFF.

*7 When STANDBY MODE is set to STANDARD. When STANDBY MODE is set to LOW POWER: 0.5 W.

*8 Results of SHARP measurements when displaying broadcast content (sub-clause 11.6) stipulated under IEC 62087 Ed. 2.0. Note that the power consumption reduction will vary depending on the images displayed.

As a part of our policy of continuous improvement, SHARP reserves the right to make design and specification changes for product improvement without prior notice. The performance specification figures indicated are nominal values of production units. There may be some deviations from these values in individual units.

Specifications

■PN-ZR01 (optional) Product Specifications

Model	PN-ZR01
Remote control sensor box dimensions inch (mm)	Approx. 1-3/8 (W) x 7/8 (D) x 5-1/8 (H) (34.2 x 23 x 130)
Remote control sensor box weight lbs. (kg)	Approx. 0.220 (0.1)

■Dimensional Drawings

Note that the values shown are approximate values.

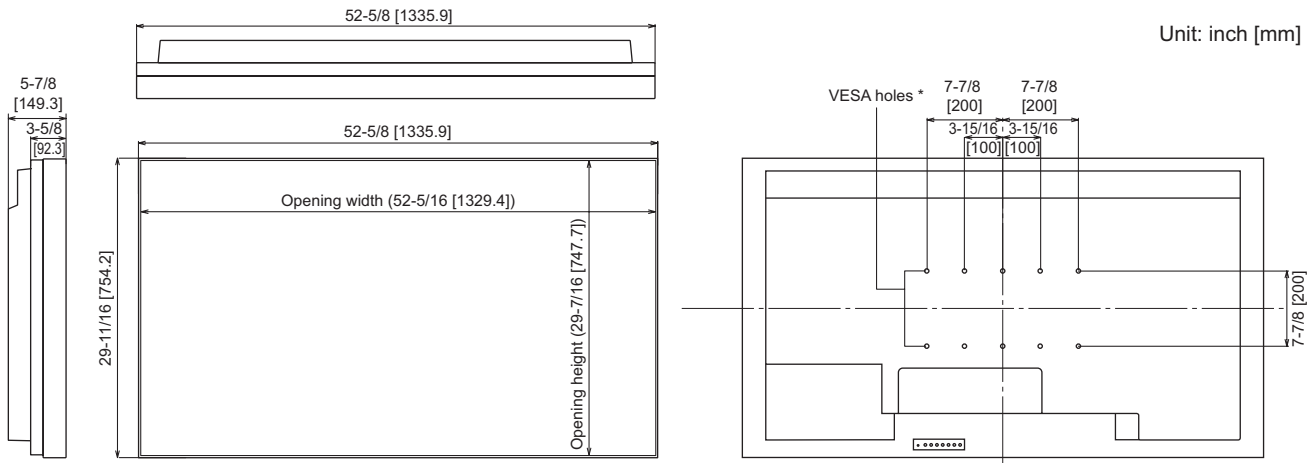

When mounting the monitor, be sure to use a wall-mount bracket that complies with the VESA-compatible mounting method. SHARP recommends using M6 screws and tighten the screws.

Note that screw hole depth of the monitor is 3/8 inch (10 mm). Loose mounting may cause the product to fall, resulting in serious personal injuries as well as damage to the product. The screw and hole should come together with over 5/16 inch (8 mm) length of thread. Use a bracket which has been approved for UL1678 standard, and which can endure at least 4 times or more the weight of the monitor.

■Power management

This monitor conforms to VESA DPMS and DVI DMPM. Both your video card and computer must support the same standard in order for the monitor's power management function to work.

DPMS: Display Power Management Signaling

DPMS	Screen	Power consumption*1	Hsync	Vsync
ON STATE	Display	510 W	Yes	Yes
STANDBY	No display	1.0 W*2	No	Yes
SUSPEND			Yes	No
OFF STATE			No	No

DMPM: Digital Monitor Power Management

DMPM	Screen	Power consumption*1
Monitor ON	Display	510 W
Active OFF	No display	1.0 W*2

*1 When PN-ZR01 (optional), or PN-ZB02 (optional) is not connected.

*2 When AUTO INPUT CHANGE is set to OFF.

■POWER LIMITED (See page 24.)

MODE	Power consumption
MODE2	195 W
MODE1	310 W
OFF	510 W

Set to ensure maximum power consumption. (See page 55.)

■DDC (plug and play)

The monitor supports the VESA DDC (Display Data Channel) standard.

DDC is a signal standard for plug and play between monitors and computers. Information about resolution and other parameters is exchanged between the two. This function can be used if the computer supports DDC and it has been configured to detect plug-and-play monitors.

There are several types of DDC, depending on the communication method used. This monitor supports DDC2B.

■Compatible signal timing (PC)

Screen resolution		Hsync	Vsync	Dot frequency	Digital		Analog (D-SUB/RGB*2)
					DVI*2	HDMI	
VESA	640 × 480	31.5kHz	60Hz	25.175MHz	Yes	Yes	Yes
		37.9kHz	72Hz	31.5MHz	Yes	Yes	Yes
		37.5kHz	75Hz	31.5MHz	Yes	Yes	Yes
	800 × 600	35.1kHz	56Hz	36.0MHz	-	-	Yes
		37.9kHz	60Hz	40.0MHz	Yes	Yes	Yes
		48.1kHz	72Hz	50.0MHz	Yes	Yes	Yes
		46.9kHz	75Hz	49.5MHz	Yes	Yes	Yes
	848 × 480	31.0kHz	60Hz	33.75MHz	Yes	-	Yes
	1024 × 768	48.4kHz	60Hz	65.0MHz	Yes	Yes	Yes
		56.5kHz	70Hz	75.0MHz	Yes	Yes	Yes
		60.0kHz	75Hz	78.75MHz	Yes	Yes	Yes
	1152 × 864 ^{*1}	67.5kHz	75Hz	108.0MHz	Yes	Yes	Yes
	1280 × 768	47.8kHz	60Hz	79.5MHz	Yes	-	Yes
		60.3kHz	75Hz	102.25MHz	Yes	-	Yes
	1280 × 800 ^{*1}	49.7kHz	60Hz	83.5MHz	Yes	Yes	Yes
	1280 × 960 ^{*1}	60.0kHz	60Hz	108.0MHz	Yes	Yes	Yes
	1280 × 1024 ^{*1}	64.0kHz	60Hz	108.0MHz	Yes	Yes	Yes
		80.0kHz	75Hz	135.0MHz	Yes	Yes	Yes
	1360 × 768	47.7kHz	60Hz	85.5MHz	Yes	Yes	Yes
1400 × 1050 ^{*1}	65.3kHz	60Hz	121.75MHz	Yes	Yes	Yes	
1440 × 900 ^{*1}	55.9kHz	60Hz	106.5MHz	Yes	-	Yes	
1600 × 1200 ^{*1}	75.0kHz	60Hz	162.0MHz	Yes	Yes	Yes	
1680 × 1050 ^{*1}	65.3kHz	60Hz	146.25MHz	Yes	Yes	Yes	
Wide	1280 × 720	44.7kHz	60Hz	74.4MHz	Yes	Yes	Yes
	1366 × 768	47.7kHz	60Hz	85.383MHz	Yes	Yes	Yes
	1920 × 1080 ^{*1}	67.5kHz	60Hz	148.5MHz	Yes	Yes	Yes
US TEXT	720 × 400	31.5kHz	70Hz	28.3MHz	Yes	Yes	Yes
Sun	1024 × 768	48.3kHz	60Hz	64.13MHz	-	-	Yes
		53.6kHz	66Hz	70.4MHz	-	-	Yes
		56.6kHz	70Hz	74.25MHz	-	-	Yes
	1152 × 900 ^{*1}	61.8kHz	66Hz	94.88MHz	-	-	Yes
		71.8kHz	76.2Hz	108.23MHz	-	-	Yes
	1280 × 1024 ^{*1}	71.7kHz	67.2Hz	117.01MHz	-	-	Yes
		81.1kHz	76Hz	134.99MHz	-	-	Yes
1600 × 1000 ^{*1}	68.6kHz	66Hz	135.76MHz	-	-	Yes	

*1 Displays a reduced image, except in Dot by Dot. In Dot by Dot, the image will be cut down to panel size then displayed.

*2 Available when the PN-ZB02 (optional) is attached.

- * Depending on the connected PC, images may not be displayed properly even if the compatible signal described above is input.
- * The frequency values for the Sun are reference values.

Specifications

Compatible signal timing (AV)

Screen resolution	Frequency	DVI-D*2	HDMI	Component
1920 × 1080p*1	24Hz	-	Yes	-
	50Hz	Yes	Yes	Yes
	59.94Hz	Yes	Yes	Yes
	60Hz	Yes	Yes	Yes
1920 × 1080i*1	50Hz	Yes	Yes	Yes
	59.94Hz	Yes	Yes	Yes
	60Hz	Yes	Yes	Yes
1280 × 720p	50Hz	Yes	Yes	Yes
	59.94Hz	Yes	Yes	Yes
	60Hz	Yes	Yes	Yes
720 × 576p	50Hz	Yes	Yes	Yes
720 × 480p	59.94Hz	Yes	Yes	Yes
	60Hz	Yes	Yes	Yes
640 × 480p(VGA)	59.94Hz	Yes	Yes	-
	60Hz	Yes	Yes	-
720(1440) × 576i	50Hz	-	Yes	Yes
720(1440) × 480i	59.94Hz	-	Yes	Yes
	60Hz	-	Yes	Yes

*1 Displays a reduced image, except in Dot by Dot. In Dot by Dot, the image will be cut down to panel size then displayed.

*2 Available when the PN-ZB02 (optional) is attached.

■PC/AV DVI-D input terminal pins

(DVI-D 24 pin)

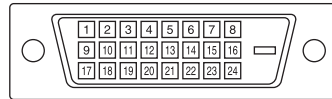

No.	Function	No.	Function
1	TMDS data 2-	13	N.C.
2	TMDS data 2+	14	+5V
3	TMDS data 2/4 shield	15	GND
4	N.C.	16	Hot-plug detection
5	N.C.	17	TMDS data 0-
6	DDC clock	18	TMDS data 0+
7	DDC data	19	TMDS data 0/5 shield
8	N.C.	20	N.C.
9	TMDS data 1-	21	N.C.
10	TMDS data 1+	22	TMDS clock shield
11	TMDS data 1/3 shield	23	TMDS clock+
12	N.C.	24	TMDS clock-

■PC/AV HDMI input terminal pins

(HDMI Connector)



No.	Function	No.	Function
1	TMDS data 2+	11	TMDS clock shield
2	TMDS data 2 shield	12	TMDS clock-
3	TMDS data 2-	13	CEC
4	TMDS data 1+	14	N.C.
5	TMDS data 1 shield	15	SCL
6	TMDS data 1-	16	SDA
7	TMDS data 0+	17	DDC/CEC GND
8	TMDS data 0 shield	18	+5V
9	TMDS data 0-	19	Hot-plug detection
10	TMDS clock+		

■PC D-sub input terminal pins

(Mini D-sub 15 pin)

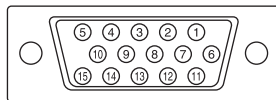

No.	Function	No.	Function
1	Red video signal input	9	+5V
2	Green video signal input	10	GND
3	Blue video signal input	11	N.C.
4	N.C.	12	DDC data
5	GND	13	Hsync signal input
6	GND for red video signal	14	Vsync signal input
7	GND for green video signal	15	DDC clock
8	GND for blue video signal		

■RS-232C input terminal pins

(D-sub 9 pin)

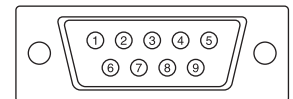

No.	Function	No.	Function
1	N.C.	6	N.C.
2	Transmitted data	7	N.C.
3	Received data	8	N.C.
4	N.C.	9	N.C.
5	GND		

■PC/AV DVI-D output terminal pins

(DVI-D 24 pin)

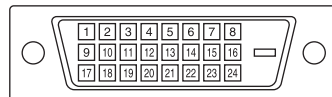

No.	Function	No.	Function
1	TMDS data 2-	13	N.C.
2	TMDS data 2+	14	+5V
3	TMDS data 2/4 shield	15	GND
4	N.C.	16	Hot-plug detection
5	N.C.	17	TMDS data 0-
6	DDC clock	18	TMDS data 0+
7	DDC data	19	TMDS data 0/5 shield
8	N.C.	20	N.C.
9	TMDS data 1-	21	N.C.
10	TMDS data 1+	22	TMDS clock shield
11	TMDS data 1/3 shield	23	TMDS clock+
12	N.C.	24	TMDS clock-

■RS-232C output terminal pins

(D-sub 9 pin)

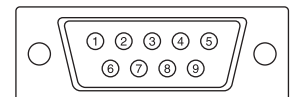

No.	Function	No.	Function
1	N.C.	6	N.C.
2	Received data	7	N.C.
3	Transmitted data	8	N.C.
4	N.C.	9	N.C.
5	GND		

SHARP[®]
SHARP CORPORATION