

# SHARP®

MODEL  
**AR-C260P**

**DIGITAL FULL COLOUR PRINTER**

**OPERATION MANUAL**  
(for general information)

	Page
• <b>BEFORE USING THE PRODUCT</b> .....	1-1
• <b>MANAGING THE MACHINE</b> .....	2-1
• <b>OPERATION CONDITION SETTINGS</b> .....	3-1
• <b>PRINTING FROM THE OPERATION PANEL</b> .....	4-1
• <b>PERIPHERAL DEVICES</b> .....	5-1
• <b>SPECIFICATIONS</b> .....	6-1

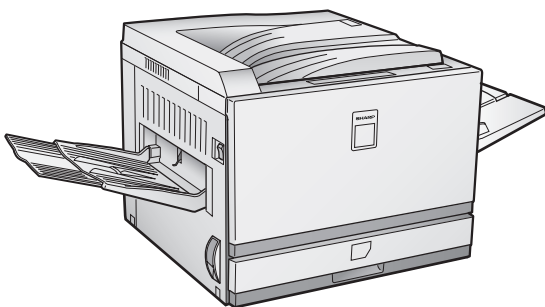

Be sure to become thoroughly familiar with this manual to gain the maximum benefit from the product.

**Before installing this product, be sure to read the installation requirements and cautions sections.**

Be sure to keep all operation manuals handy for reference including this manual, and operation manuals for any optional equipment which has been installed.

In some areas, the "POWER" switch positions are marked "I" and "⏻" on the copier instead of "ON" and "OFF".

The symbol "⏻" denotes the copier is not completely de-energized but in a stand-by condition at this "POWER" switch position.

If your copier is so marked, please read "I" for "ON" and "⏻" for "OFF".

**Caution!**

**For a complete electrical disconnection, pull out the main plug.**

**The socket-outlet shall be installed near the equipment and shall be easily accessible.**

This equipment complies with the requirements of Directives 89/336/EEC and 73/23/EEC as amended by 93/68/EEC.

Dieses Gerät entspricht den Anforderungen der EG-Richtlinien 89/336/EWG und 73/23/EWG mit Änderung 93/68/EWG.

Ce matériel répond aux exigences contenues dans les directives 89/336/CEE et 73/23/CEE modifiées par la directive 93/68/CEE.

Dit apparaat voldoet aan de eisen van de richtlijnen 89/336/EEG en 73/23/EEG, gewijzigd door 93/68/EEG.

Dette udstyr overholder kravene i direktiv nr. 89/336/EEC og 73/23/EEC med tillæg nr. 93/68/EEC.

Quest' apparecchio è conforme ai requisiti delle direttive 89/336/EEC e 73/23/EEC, come emendata dalla direttiva 93/68/EEC.

Η εγκατάσταση αυτή ανταποκρίνεται στις απαιτήσεις των οδηγιών της Ευρωπαϊκής Ένωσης 89/336/EOK και 73/23/EOK, όπως οι κανονισμοί αυτοί συμπληρώθηκαν από την οδηγία 93/68/EOK.

Este equipamento obedece às exigências das directivas 89/336/CEE e 73/23/CEE, na sua versão corrigida pela directiva 93/68/CEE.

Este aparato satisface las exigencias de las Directivas 89/336/CEE y 73/23/CEE, modificadas por medio de la 93/68/CEE.

Denna utrustning uppfyller kraven enligt riktlinjerna 89/336/EEC och 73/23/EEC så som kompletteras av 93/68/EEC.

Dette produktet oppfyller betingelsene i direktivene 89/336/EEC og 73/23/EEC i endringen 93/68/EEC.

Tämä laite täyttää direktiivien 89/336/EEC ja 73/23/EEC vaatimukset, joita on muutettu direktiivillä 93/68/EEC.

The CE mark logo label is affixed on an equipment in case that the directives described in the above sentence are applicable to the product. (This sentence is not applicable in any country where the above directives are not required.)

Shielded Network cable, USB cable and Centronics cable must be used with this equipment to maintain compliance with standards.

---

# OPERATION MANUALS

The following operation manuals are provided with the machine.

- **Operation manual (for general information) (this manual):**

This manual provides general information about the machine, including safety information, loading paper, removing misfeeds, and regular maintenance.

- **Software setup guide (for printer):**

This explains the contents of the accompanying CD-ROM and the procedure for installing the software.

- **Operation manual (for printer)\* :**

This manual explains the procedures for using the machine as a printer.

- **Key operator's guide\*:**

This explains key operator programs for machine management.

Key operator programs are used by key operators to customize the machine to meet the needs of the customer.

\* The Operation manual (for printer) and the Key operator's guide are provided as PDF files in the CD-ROM that accompanies the AR-C260P.

These manuals are not provided as printed manuals.

## NOTES

- Considerable care has been taken in preparing this manual. If you have any comments or concerns about the manual, please contact your nearest SHARP Service Department.
- This product has undergone strict quality control and inspection procedures. In the unlikely event that a defect or other problem is discovered, please contact your dealer or nearest SHARP Service Department.
- Aside from instances provided for by law, SHARP is not responsible for failures occurring during use of the product or its options, or failures due to incorrect operation of the product and its options, or other failures, or for any damage that occurs due to use of the product.

# INSTALLATION REQUIREMENTS

Improper installation may damage this product. Please note the following during initial installation and whenever the machine is moved.

1. The machine should be installed near an accessible power outlet for easy connection.

2. Be sure to connect the power cord only to a power outlet that meets the specified voltage and current requirements. Make sure that the outlet is properly grounded.

- For the power supply requirements, see the name plate on the main unit.

3. Do not install the machine in areas that are:

- damp, humid, or dusty
- exposed to direct sunlight
- poorly ventilated
- subject to extreme temperature or humidity changes, e.g., near an air conditioner or heater.

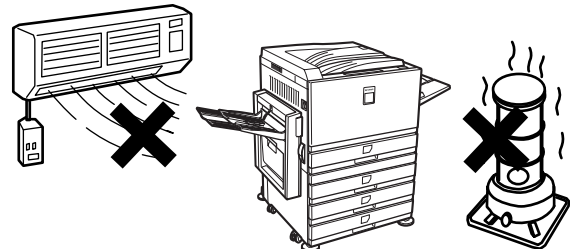
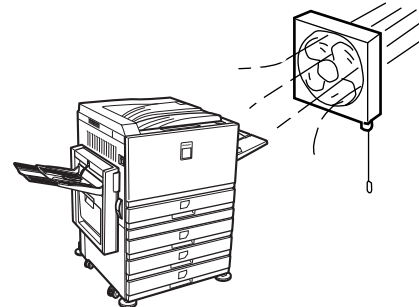
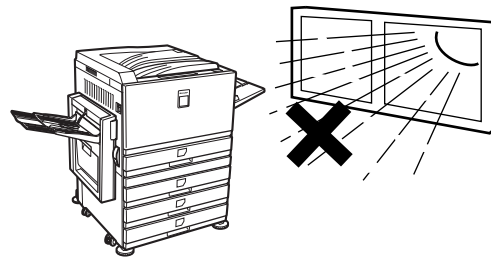
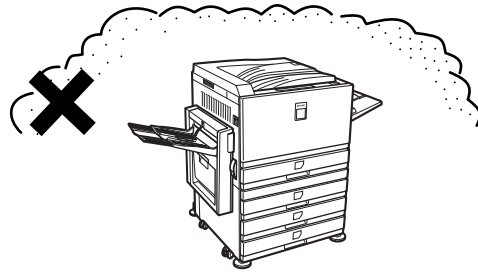

4. Be sure to allow the required space around the machine for servicing and proper ventilation.

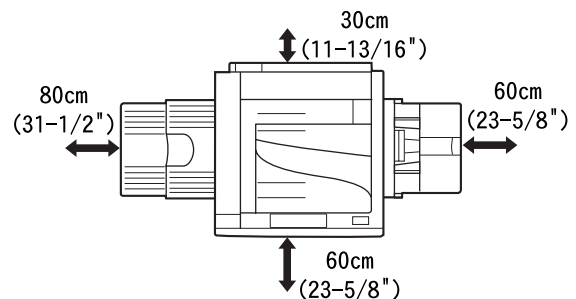

A small amount of ozone is produced within the printer during operation. The emission level is insufficient to cause any health hazard.

**NOTE:**

The present recommended long term exposure limit for ozone is 0.1 ppm (0.2 mg/m<sup>3</sup>) calculated as an 8 hr. time-weighted average concentration.

However, since the small amount that is emitted may have an objectionable odor, it is advisable to place the copier in a ventilated area.

## Moving this machine

Pull out the four handles as shown below, grasp them firmly, and keep the machine horizontal while moving it.

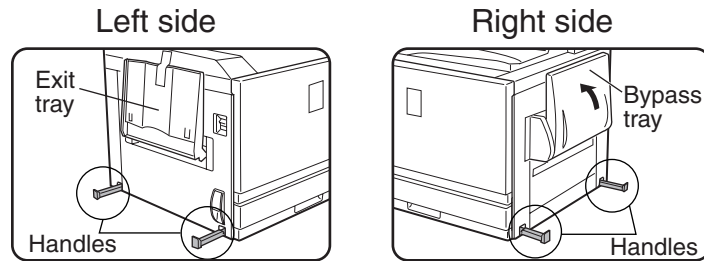

Before lifting the machine, fold up the exit tray and tape it securely to the machine.

Before lifting the machine, fold up the bypass tray and tape it securely to the machine.

### Caution

Two people are required to lift and carry this machine.

### If the machine has been placed on a stand/paper drawer:

The stand/paper drawer is on casters for moving. Unlock the adjusters of the stand/paper drawer and gently move the machine, taking care to steady it to prevent it from toppling.

To lock and unlock the adjusters, see page 0-4.

### If the machine is to be left unused for a long time

If the machine is to be left unused for a month or longer, follow the procedure on pages 2-6 and 2-7 to release the pressure on the fusing roller.

# CAUTIONS

1. Do not touch the photoconductive drum. Scratches or smudges on the drum will cause dirty prints.
2. The fusing unit is extremely hot. Exercise care in this area.
3. Four adjusters are provided on all optional stand/paper drawer units. These adjusters should be lowered until they contact the floor. When moving the machine with the optional stand/paper drawer, be sure to raise the adjusters. Also, unlock the two casters at the front of the optional stand/paper drawer. After moving the machine, lower the four adjusters until they reach the floor and lock the two casters.
4. Do not make any modifications to this machine. Doing so may result in personal injury or damage to the machine.
5. Since this machine is heavy, it is recommended that it be moved by more than one person to prevent injury.
6. When connecting this machine to a computer, be sure to first turn both the computer and the machine off.
7. Do not print anything which is prohibited from printing by law. The following items are normally prohibited from printing by national law. Other items may be prohibited by local law.
  - Money ● Stamps ● Bonds ● Stocks
  - Bank drafts ● Checks ● Passports
  - Driver's licences

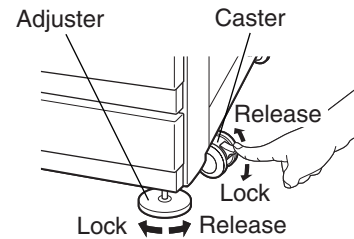
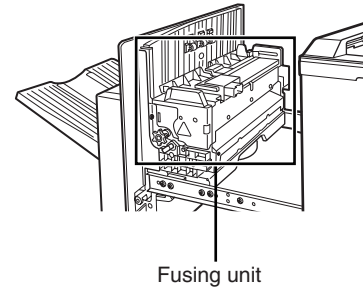

## "BATTERY DISPOSAL"

THIS PRODUCT CONTAINS A LITHIUM PRIMARY MEMORY BACK-UP BATTERY THAT MUST BE DISPOSED OF PROPERLY. PLEASE CONTACT YOUR LOCAL SHARP DEALER OR AUTHORISED SERVICE REPRESENTATIVE FOR ASSISTANCE IN DISPOSING OF THIS BATTERY.

# CONTENTS

OPERATION MANUALS.....	0-1
INSTALLATION REQUIREMENTS.....	0-2
● Moving this machine .....	0-3
CAUTIONS.....	0-4
CONTENTS .....	0-5

## CHAPTER 1 BEFORE USING THE PRODUCT

INTRODUCTION.....	1-2
MAIN FEATURES .....	1-3
PART NAMES AND FUNCTIONS .....	1-4
● Exterior .....	1-4
● Interior.....	1-5
● Part names and functions of peripheral devices.....	1-6
● Operation panel .....	1-8

## CHAPTER 2 MANAGING THE MACHINE

LOADING PAPER.....	2-2
● Tray numbers.....	2-2
● Loading paper in paper tray 1 .....	2-2
● Changing the paper size in paper tray 1 .....	2-3
● Loading paper in the bypass tray.....	2-4
● Loading paper in the stand/1 x 500 sheet paper drawer/stand/3 x 500 sheet paper drawer .....	2-7
● Specifications (stand/1 x 500 sheet paper drawer/ stand/3 x 500 sheet paper drawer) .....	2-7
● Loading paper in the duplex module/2 x 500 sheet paper drawer.....	2-8
● Specifications (duplex module/2 x 500 sheet paper drawer).....	2-8
● Specifications of paper trays.....	2-9
● Structure of the tray setting menu (except for the bypass tray) .....	2-11
● Setting the paper type (except for the bypass tray) ...	2-12
● Specifying the size when the paper size is set to "Extra" (except for the bypass tray) .....	2-13
● Structure of the bypass tray setting menu .....	2-14
● Setting the paper type and paper size in the bypass tray ...	2-15
CUSTOM SETTINGS.....	2-17
● Basic procedure for custom settings.....	2-17
● Structure of the custom settings menu .....	2-18
● Setting items .....	2-19
REPLACING THE TONER CARTRIDGES .....	2-20
STORAGE OF SUPPLIES .....	2-22
CLEANING THE CABINET .....	2-22
MISFEED REMOVAL.....	2-23
● Misfeed in the paper feed area .....	2-24
● Misfeed in the transport area, fusing area, and exit area ....	2-25
● Misfeed in the stand/1 x 500 sheet paper drawer .....	2-26
● Misfeed in the stand/3 x 500 sheet paper drawer .....	2-26
● Misfeed in the duplex bypass/inverter unit and duplex module/2 x 500 sheet paper drawer.....	2-27
TROUBLESHOOTING .....	2-29

## CHAPTER 3 OPERATION CONDITION SETTINGS

CONFIGURING THE OPERATION CONDITION SETTINGS.....	3-2
● Basic procedure for operation condition settings (settings that can be configured from the operation panel) .....	3-2
● Structure of the operation conditions menu .....	3-3
● Default settings .....	3-4
● PCL settings.....	3-5
● Print PS errors.....	3-6

## CHAPTER 4 PRINTING FROM THE OPERATION PANEL

HOLD JOB LIST .....	4-2
---------------------	-----

## CHAPTER 5 PERIPHERAL DEVICES

SADDLE STITCH FINISHER .....	5-2
● Part names.....	5-2
● Specifications .....	5-2
● Staple cartridge replacement and staple jam removal..	5-4
● Misfeed in the saddle stitch finisher .....	5-7
LARGE CAPACITY TRAY .....	5-9
● Part name.....	5-9
● Specifications .....	5-9
● Loading paper .....	5-10
● Misfeed removal.....	5-11

## CHAPTER 6 SPECIFICATIONS

SPECIFICATIONS.....	6-2
● Printer.....	6-2
● Duplex bypass/inverter unit (optional).....	6-4
● Print area.....	6-4
INDEX.....	6-5







# CHAPTER 1

---

## BEFORE USING THE PRODUCT

---

This chapter contains basic information that should be read before using the product.

	Page
INTRODUCTION .....	1-2
MAIN FEATURES .....	1-3
PART NAMES AND FUNCTIONS .....	1-4
• Exterior .....	1-4
• Interior .....	1-5
• Part names and functions of peripheral devices .....	1-6
• Operation panel .....	1-8

# INTRODUCTION

This product is a high speed Digital full colour printer. Optional peripheral devices are available for the product that expand its capabilities to meet a wide range of needs.

This manual contains general information on using the machine, including installation requirements, safety information, and procedures for loading paper, replacing the toner cartridge, and removing misfeeds. For information on printing from a computer connected to the machine and installing the printer driver, please see the additional manuals that are provided with the machine.

## Paper sizes

This machine allows use of standard sizes in both the AB and inch systems. These are shown in the tables below.

Sizes in the AB system
A3W
A3
B4
A4
B5
A5

Sizes in the inch system	
When the machine is being operated from the operation panel:	In this manual, the indications below are used.
12 x 18	12" x 18"
LEDGER	11" x 17"
LEGAL	8-1/2" x 14"
FOOLSCAP	8-1/2" x 13"
LETTER	8-1/2" x 11"
EXECUTIVE	7-1/4" x 10-1/2"
INVOICE	5-1/2" x 8-1/2"

## The meaning of "R" in paper size indications in manuals

Some paper sizes can be placed in either the portrait or landscape orientations. To differentiate between landscape and portrait, the landscape orientation size indication will contain an "R". These are indicated as A4R, B5R, 8-1/2" x 11"R, 5-1/2" x 8-1/2"R, etc. Sizes that can be placed only in the landscape orientation ( A3, B4, 11" x 17", 8-1/2" x 14", 8-1/2" x 13") do not contain the "R" in their size indication.

Size indication with "R"



Landscape orientation

Size indication without "R"

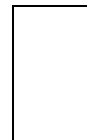

Portrait orientation

# MAIN FEATURES

## 1 Brilliant full colour printing based on digital image processing

Prints high-resolution 600 dpi images in brilliant full colour at a blazing speed of 26 pages per minute (A4 or letter size). Black and white printing is even faster at 32 pages per minute\* (A4 or letter size).

\*When the same document is printed repeatedly without using the offset function.

## 2 A range of optional units to enhance productivity

A range of optional equipment is available to enhance productivity, such as duplex units for producing two-sided output, additional paper feed units to increase the number of available paper sizes and paper capacity, and paper output units that are capable of stapling and saddle stitch binding.

## 3 Standard offset function makes it easy to distinguish between sets of prints

As sets of prints are delivered to the centre tray, each set is offset from the previous set for easy separation.

## 4 PostScript compatible

Installation of an optional PS3 expansion kit (AR-PK4) gives PostScript compatibility (PostScript 3).

### Energy saving features

This product has the following two power reducing modes that conform to the Energy Star guidelines to help conserve natural resources and reduce environmental pollution.

#### Preheat mode

The preheat mode is the first level of power reduction. The power is reduced to the fuser unit a preset time after the machine has completed a job and no further machine operations have been performed. The machine can recover to the ready condition within a short period of time. The preset time to enter the mode can be set by a key operator program.

#### Auto power shut-off mode

The auto power shut-off mode is the second level of power reduction. In this mode power is shut off to the fusing unit and the message display. In this state more energy is saved than in the preheat mode but the time to recover to the ready condition will be longer. The preset time to enter this mode can be set by a key operator program.

When either of the above modes is active, the mode will be deactivated automatically by an incoming job and the machine will automatically warm up and start to print when it has reached the ready temperature.

Either mode will also be deactivated by any key operation on the operation panel.



As an ENERGY STAR® Partner, SHARP has determined that this product meets the ENERGY STAR® guidelines for energy efficiency.

# PART NAMES AND FUNCTIONS

## Exterior

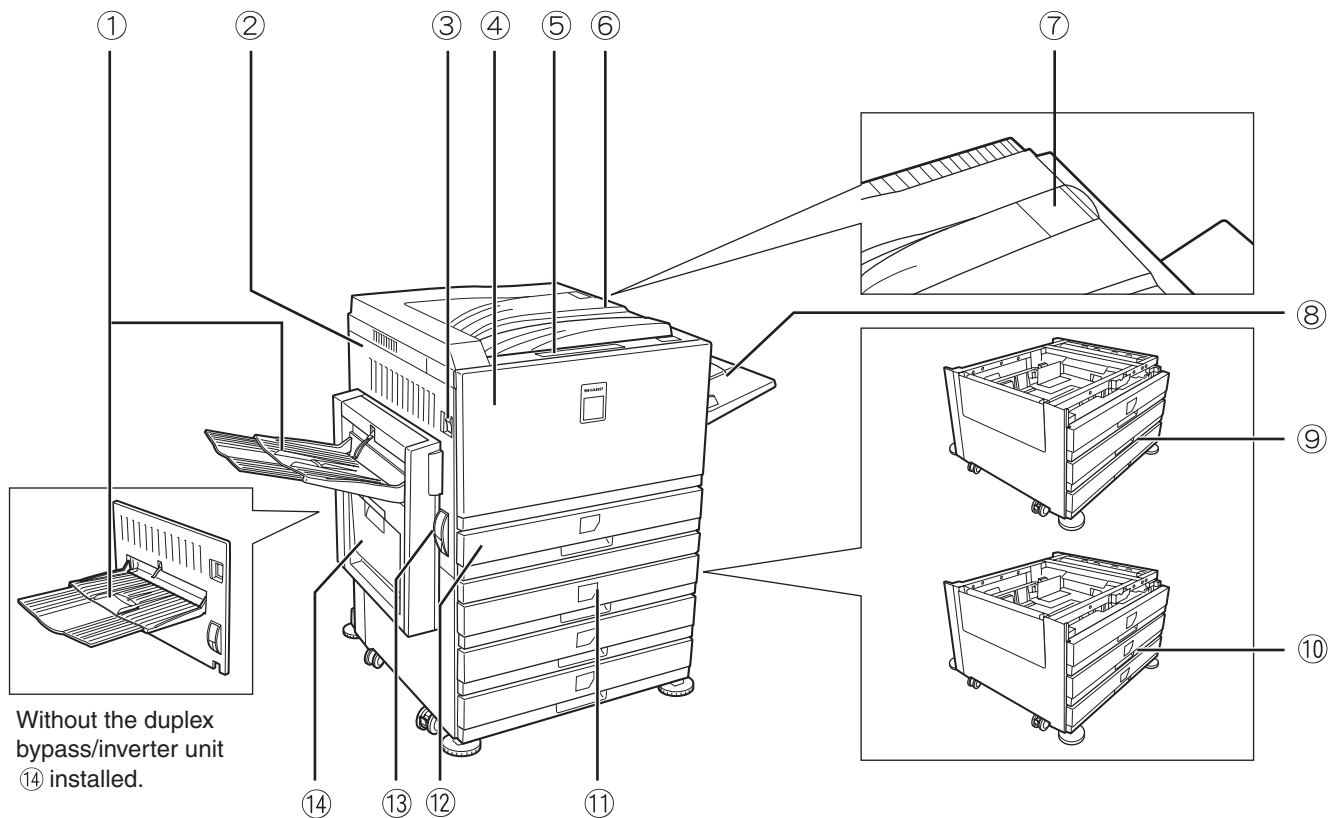

- ① **Left tray**  
Finished sheets are deposited here.  
Paper that cannot be output to the centre tray is output face-up to the left tray.
- ② **Left side cover**  
Open this cover when a paper misfeed occurs in the fusing unit or the transfer unit.
- ③ **Main switch**  
Press to turn power on and off.
- ④ **Front cover**  
Open to replace toner cartridge.
- ⑤ **Operation panel**
- ⑥ **Centre tray**  
Finished sheets are deposited here.
- ⑦ **Paper stopper**  
To prevent output paper from falling.
- ⑧ **Bypass tray**  
Special papers (including transparency film) and paper can be fed from the bypass tray.
- ⑨ **Stand/1 x 500 sheet paper drawer \* (See page 2-7)**
- ⑩ **Stand/3 x 500 sheet paper drawer \* (See page 2-7)**
- ⑪ **Duplex module/2 x 500 sheet paper drawer \* (See page 2-8)**
- ⑫ **Paper tray**  
Each tray can hold approximately 500 sheets of the recommended paper for colour (80 g/m<sup>2</sup> or 20 lbs.), or approximately 500 sheets of SHARP standard paper (80 g/m<sup>2</sup> or 20 lbs.).
- ⑬ **Left side cover release**  
Push this release up to open the left side cover.
- ⑭ **Duplex bypass/inverter unit \* (See page 1-6)**

\* ⑨, ⑩, ⑪ and ⑭ are peripheral devices. For a description of these devices, see page 1-6.

# Interior

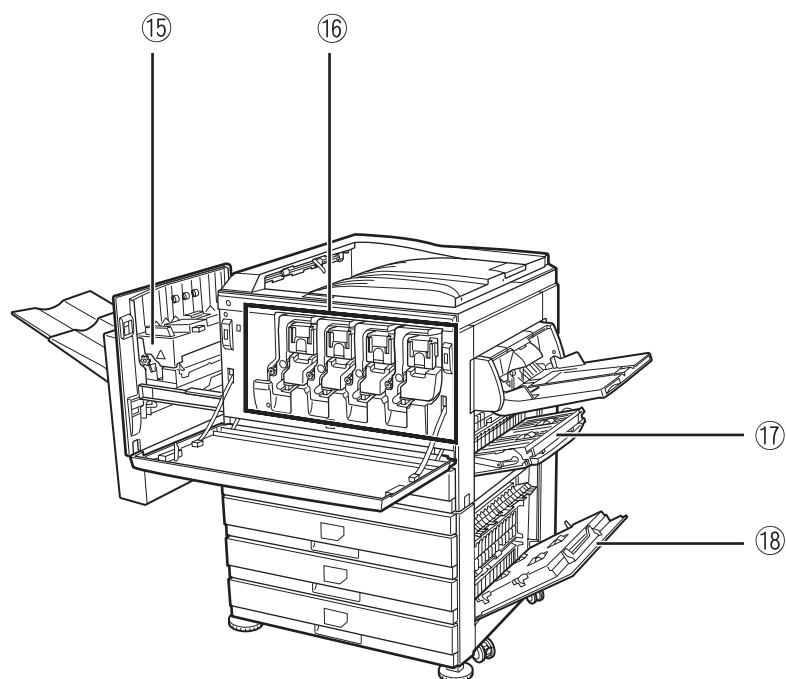

## 15 Fusing unit

Toner images are fused here.

### CAUTION

The fusing unit is hot. Take care in removing misfed paper.

## 16 Toner cartridge

The toner cartridge must be replaced when indicated on the operation panel. (See page 2-20)

## 17 Right side cover

Open when a misfeed has occurred in the paper feed area.

## 18 Right cover of paper drawer

Open this cover to remove paper misfed in the paper drawer.

## Part names and functions of peripheral devices

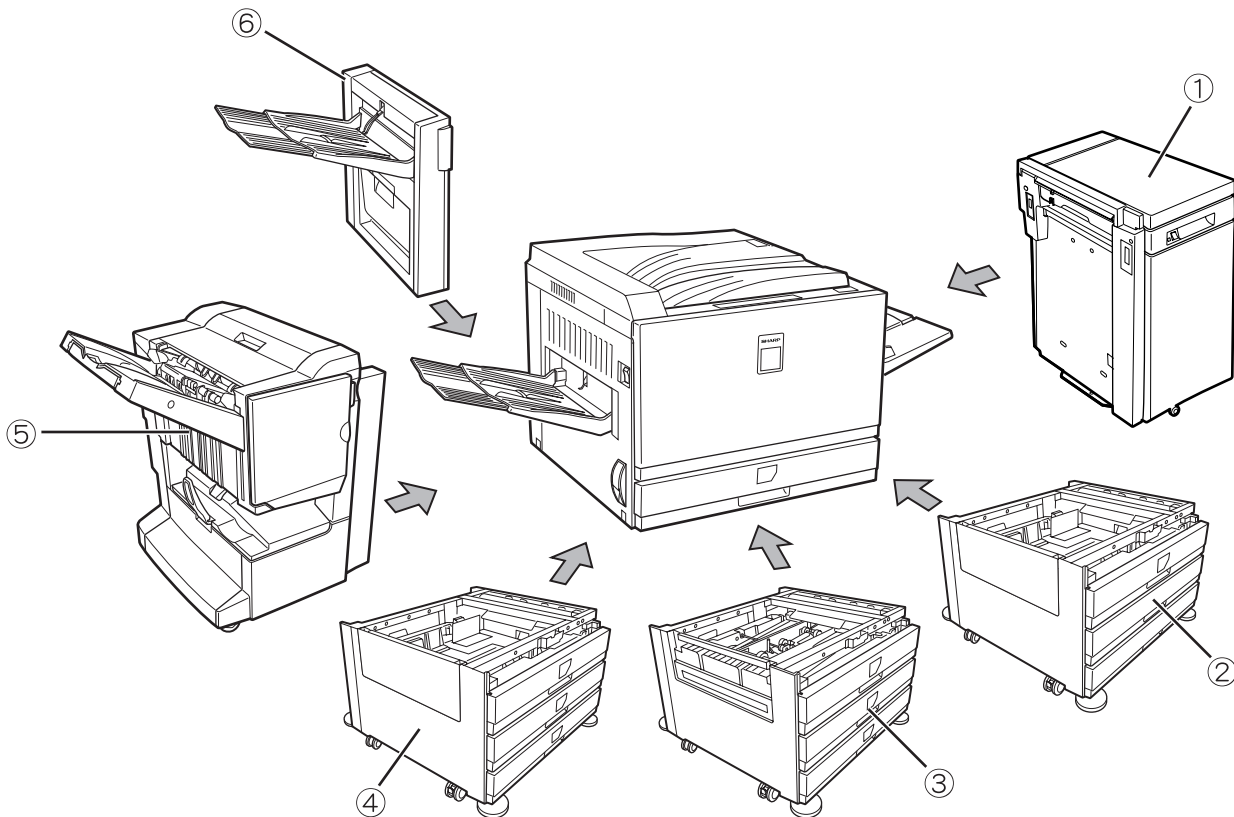

① **Large Capacity tray (AR-LC5N)**

The large capacity tray provides the convenience of having 3,000 additional sheets of A4 or 8-1/2" x 11" paper (80 g/m<sup>2</sup> or 20 lbs.) available.

② **Stand/1 x 500 sheet paper drawer (AR-D17)**

This stand has one paper tray. It can hold approximately 500 sheets of the recommended paper for colour (80 g/m<sup>2</sup> or 20 lbs.), or approximately 500 sheets of SHARP standard paper (80 g/m<sup>2</sup> or 20 lbs.).

③ **Duplex module/2 x 500 sheet paper drawer (AR-D19)**

This stand includes a module for automatic two-sided printing and two paper trays. The two trays can hold approximately 500 sheets of the recommended paper for colour (80 g/m<sup>2</sup> or 20 lbs.), or approximately 500 sheets of SHARP standard paper (80 g/m<sup>2</sup> or 20 lbs.). To perform two-sided printing, a duplex bypass/inverter unit (AR-RB1) is required.

④ **Stand/3 x 500 sheet paper drawer (AR-D18)**

This stand has three paper trays. Each tray can hold approximately 500 sheets of the recommended paper for colour (80 g/m<sup>2</sup> or 20 lbs.), or approximately 500 sheets of SHARP standard paper (80 g/m<sup>2</sup> or 20 lbs.).

⑤ **Saddle stitch finisher (AR-F13)**

The finisher can deliver sets saddle stitched and folded at the paper centreline to form a pamphlet, edge stapled in three different modes, or unstapled. For two-hole or three-hole output, a hole punch module must be installed.

⑥ **Duplex bypass/inverter unit (AR-RB1)**

This module is required to automatically turn paper over within the machine for face-down output to the left exit tray.

### ■ Other optional equipment

**PS3 expansion kit (AR-PK4)**

This kit provides compatibility of PostScript level 3 to the printer.

**Data Security Kit (AR-FR8)**

This kit provides security function to the Printer.

## ■ Face-up and face-down output

After printing, the paper is delivered to the exit tray. This product has two exit trays (centre tray and left tray). The paper specifications (page 6-3) and output conditions differ for each tray; however, if the paper and output conditions are such that the paper can be delivered to either tray, you can select the tray to which the paper will go.

- Paper exits to the centre tray face-down only.
- Paper exits to the left tray face-up only. However, if a duplex bypass/inverter unit has been installed, face-down output is also possible. In this case, face-up or face-down output is automatically selected according to the paper and output conditions (it is not possible to manually select face-up or face-down.)

1

## Operation panel

The display and indicators show the current status of the printer. All printer settings are configured by using the keys and display panel.

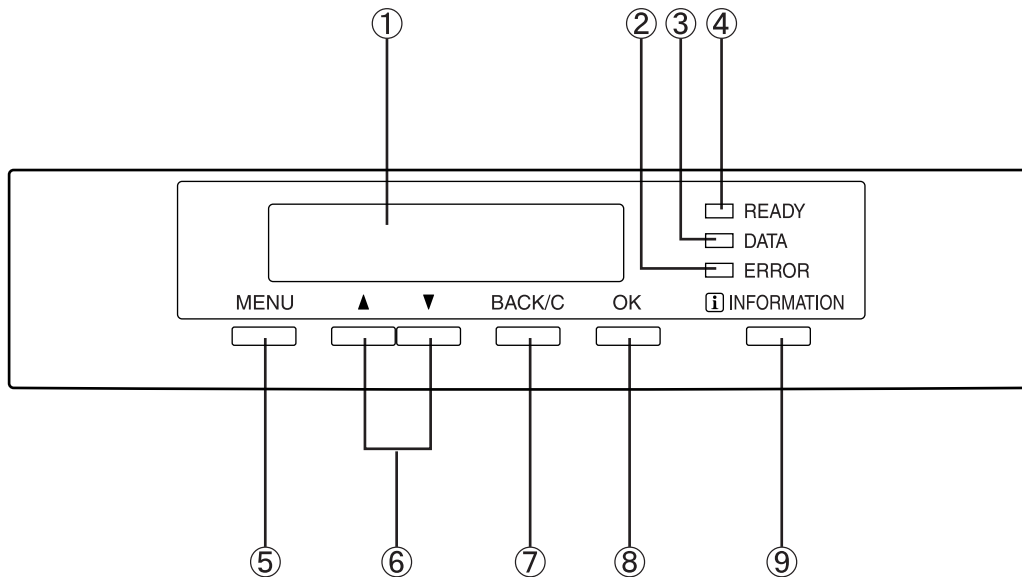

### ① Message display

Displays the current status of the printer.  
[ i ] displayed in any message indicates that the [INFORMATION] key should be pressed.

### ② [ERROR] indicator

Lights up when paper or toner must be added or when a misfeed has occurred in the machine. Blinks when an abnormal condition has occurred in the machine.

### ③ [DATA] indicator

Lights up or blinks when print data is being received or output. Also lights up when job data is stored by the job retention function.

### ④ [READY] indicator

Print data can be received when this indicator is lit.

### ⑤ [MENU] key

Press to select a menu group such as the operation conditions (page 3-2), custom settings (page 2-17), or execution of print jobs held by the retention function (page 4-2). This key can also be pressed to return to the job status screen from each of the menu groups.

See the next page for the detail of menu group.

### ⑥ [▲ / ▼] keys

Press to scroll through settings or selections for settings.

### ⑦ [BACK/C] key

Use this key to return to the previous setting level, or to cancel the currently selected job.

### ⑧ [OK] key

Press to select a setting or function, or to store a setting.

### ⑨ [INFORMATION] key

When [ i ] is displayed with a message indicating a paper misfeed, the procedure to follow can be displayed by pressing the [INFORMATION] key. If the [INFORMATION] key or the [BACK/C] key is pressed while the procedure is displayed, the information mode will be cancelled. If you hold down this key in standby or during printing, the total number of printed pages will be displayed.



## Menu groups and using the keys on the operation panel

There are 6 menu groups. The menu groups are consecutively displayed by pressing the [MENU] key. To select a menu group, display the menu group and then press the [OK] key. The first setting or function in the group will appear.

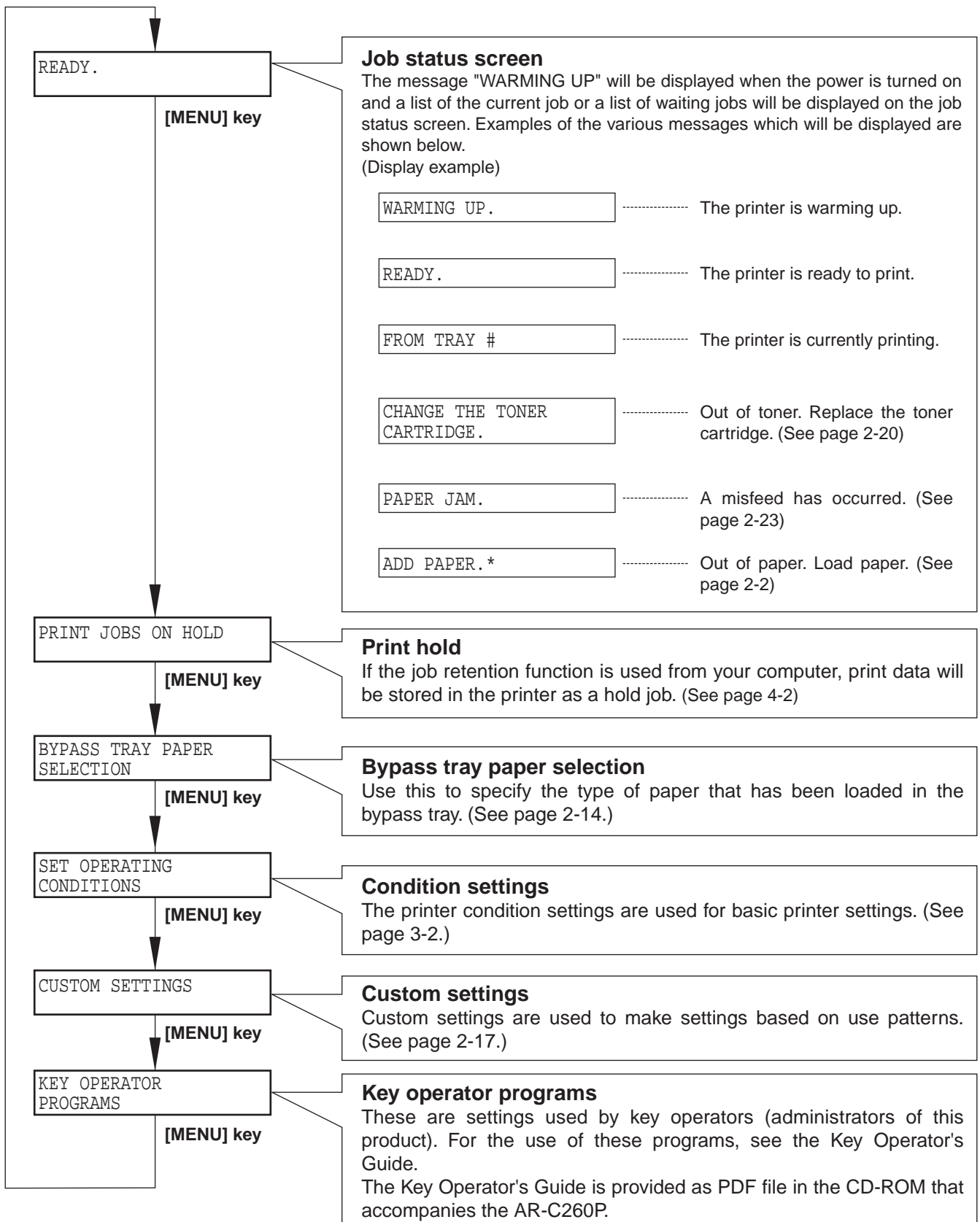

## Cancelling a print job and deleting print data

- To cancel a print job that is in progress and delete the print data, press the [BACK/C] key during printing. A message asking you to confirm the cancellation will appear. To cancel the print job, press the [OK] key. If you do not wish to cancel the print job, press the [BACK/C] key.

- To delete a job that is waiting to be printed, follow these steps.

Example: The display shows the job currently in progress

```
FROM TRAY1
▼01:USER01
```

- 1** With the display initially showing the job that is currently in progress.

```
FROM TRAY1
▼01:USER01
```

- 2** Press the ▲ or ▼ key until the job that you wish to delete appears.

```
WAITING.
▼02:USER02
```

- 3** Press the [BACK/C] key.

- 4** A message asking you to confirm the job deletion will appear.

```
DELETE THE DATA-OK?
02:USER02
```

- 5** To delete the waiting job, press the [OK] key. If you do not wish to delete the waiting job, press the [BACK/C] key.

- 6** If you pressed the [OK] key in step 5, the display will briefly show the message below, and then the next waiting job. To delete another waiting job, repeat steps 2 through 5. If there are no other waiting jobs, you will return to the display of step 1.

```
DELETED.
02:USER02
```

# CHAPTER 2

## MANAGING THE MACHINE

This chapter explains how to load paper, replace the toner cartridge, and remove paper misfeeds. It also contains information about supplies.

	Page
LOADING PAPER.....	2-2
• Tray numbers .....	2-2
• Loading paper in paper tray 1 .....	2-2
• Changing the paper size in paper tray 1 .....	2-3
• Loading paper in the bypass tray .....	2-4
• Loading paper in the stand/1 x 500 sheet paper drawer/stand/3 x 500 sheet paper drawer .....	2-7
• Specifications (stand/1 x 500 sheet paper drawer/stand/3 x 500 sheet paper drawer) .....	2-7
• Loading paper in the duplex module/2 x 500 sheet paper drawer .....	2-8
• Specifications (duplex module/2 x 500 sheet paper drawer) .....	2-8
• Specifications of paper trays .....	2-9
• Structure of the tray setting menu (except for the bypass tray) .....	2-11
• Setting the paper type (except for the bypass tray) .....	2-12
• Specifying the size when the paper size is set to "Extra" (except for the bypass tray).....	2-13
• Structure of the bypass tray setting menu.....	2-14
• Setting the paper type and paper size in the bypass tray .....	2-15
CUSTOM SETTINGS .....	2-17
• Basic procedure for custom settings .....	2-17
• Structure of the custom settings menu.....	2-18
• Setting items .....	2-19
REPLACING THE TONER CARTRIDGES .....	2-20
STORAGE OF SUPPLIES .....	2-22
CLEANING THE CABINET .....	2-22
MISFEED REMOVAL .....	2-23
• Misfeed in the paper feed area .....	2-24
• Misfeed in the transport area, fusing area, and exit area.....	2-25
• Misfeed in the stand/1 x 500 sheet paper drawer .....	2-26
• Misfeed in the stand/3 x 500 sheet paper drawer .....	2-26
• Misfeed in the duplex bypass/inverter unit and duplex module/2 x 500 sheet paper drawer .....	2-27
TROUBLESHOOTING .....	2-29

# LOADING PAPER

The message "ADD PAPER" or "ADD PAPER ONTO BYPASS TRAY" will appear when paper runs out during operation. Follow the procedure below to load paper.

## NOTES

- Do not use curled or folded paper. Doing so may cause a misfeed.
- For best results use paper supplied by SHARP. (See pages 2-10, 2-22.)
- When you change the paper type and size in paper tray 1, you must change the paper type and size settings. (see pages 2-3, 2-11 to 2-13)
- Do not place heavy objects or press hard on any tray which is pulled out.

## Tray numbers

The trays are named by number: tray 1, tray 2, tray 3, tray 4, and tray 5. The trays are described in the following table.

Tray name	Machine only	Machine + Stand/1 x 500 sheet paper drawer (AR-D17)	Machine + Stand/1 x 500 sheet paper drawer (AR-D17) + Large capacity tray (AR-LC5N)	Machine + Stand/3 x 500 sheet paper drawer (AR-D18)	Machine + Stand/3 x 500 sheet paper drawer (AR-D18) + Large capacity tray (AR-LC5N)	Machine + Duplex module/2 x 500 sheet paper drawer (AR-D19) + Duplex bypass/inverter unit (AR-RB1)	Machine + Duplex module/2 x 500 sheet paper drawer (AR-D19)+ Large Capacity tray (AR-LC5N) + Duplex bypass/inverter unit (AR-RB1)
Tray 1	Machine tray (Paper tray 1)	Machine tray (Paper tray 1)	Machine tray (Paper tray 1)	Machine tray (Paper tray 1)	Machine tray (Paper tray 1)	Machine tray (Paper tray 1)	Machine tray (Paper tray 1)
Tray 2	—	Stand/1 x 500 sheet paper drawer (AR-D17)	Stand/1 x 500 sheet paper drawer (AR-D17)	1st tray of Stand/3 x 500 sheet paper drawer (AR-D18)	1st tray of Stand/3 x 500 sheet paper drawer (AR-D18)	2nd tray of Duplex module/ 2 x 500 sheet paper drawer (AR-D19)	2nd tray of Duplex module/ 2 x 500 sheet paper drawer (AR-D19)
Tray 3	—	—	Large capacity tray (AR-LC5N)	2nd tray of Stand/3 x 500 sheet paper drawer (AR-D18)	2nd tray of Stand/3 x 500 sheet paper drawer (AR-D18)	3rd tray of Duplex module/ 2 x 500 sheet paper drawer (AR-D19)	3rd tray of Duplex module/ 2 x 500 sheet paper drawer (AR-D19)
Tray 4	—	—	—	3rd tray of Stand/3 x 500 sheet paper drawer (AR-D18)	3rd tray of Stand/3 x 500 sheet paper drawer (AR-D18)	—	Large capacity tray (AR-LC5N)
Tray 5	—	—	—	—	Large capacity tray (AR-LC5N)	—	—

## Loading paper in paper tray 1

### 1 Pull out paper tray 1.

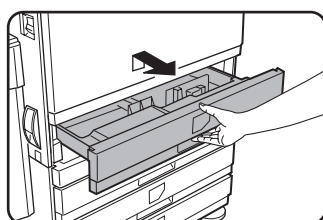

Gently pull the tray out until it stops.

### 2 Load paper in the tray.

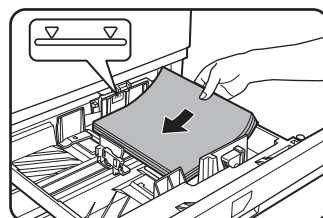

Load a stack of paper no higher than the indicator line (about 500 sheets of the recommended paper for colour (80 g/m<sup>2</sup> or 20 lbs.), or approximately 500 sheets of SHARP standard paper (80 g/m<sup>2</sup> or 20 lbs.)).

### 3 Gently push tray 1 into the machine.

Push the tray firmly all the way into the machine.

### 4 Set the paper type.

If you loaded a different type of paper than the previous paper, be sure to set the new paper type as explained in "Setting the paper type" (page 2-12).

#### NOTE

If you load a different size of the same type of paper, you only need to change the position of the size slide (see step 2 below); you do not need to change the paper type.

### 5 This completes the procedure for loading paper in paper tray 1.

## Changing the paper size in paper tray 1

The following paper size settings are available for paper tray 1: A3 to A5 (11" x 17" to 8-1/2" x 5-1/2") and "EXTRA"\*1. Use the following procedure to change the size as needed.

\*1 This is limited to square or rectangular paper that is A3 to A5 (11" x 17" to 8-1/2" x 5-1/2") in size.

### 1 Pull out paper tray 1.

If paper remains in the tray, remove it.

### 2 Adjust the paper size slide to the paper size.

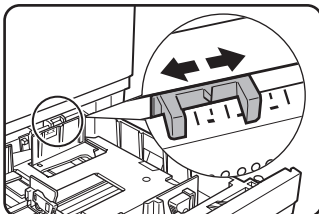

Move the paper size slide right or left to the appropriate paper size.

If a size of paper other than A3 to A5 (11" x 17" to 8-1/2" x 5-1/2") is loaded, set the size slide

to "EXTRA" and then set the specific paper size as explained in "Specifying the size when the paper size is set to "Extra" (except for the bypass tray)" (page 2-13). (Be sure to set the specific paper size; if you do not specify what the "extra" size is, part or all of the image may not print.)

### 3 Adjust the guide plates A and B by squeezing their lock levers and sliding them to the appropriate paper size.

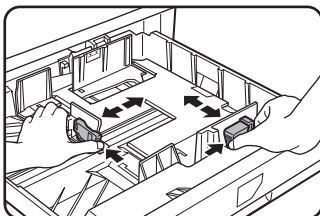

### 4 Load paper in the tray.

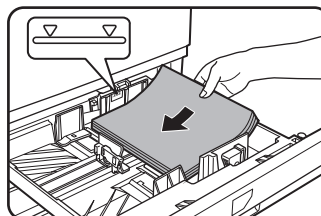

### 5 Gently push tray 1 into the machine.

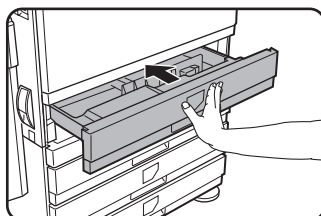

Push the tray firmly all the way into the machine.

### 6 Set the paper type.

If you loaded a different type of paper than the previous paper, be sure to set the new paper type as explained in "Setting the paper type" (page 2-12).

### 7 This completes the procedure for changing the paper size setting of paper tray 1.

#### NOTE

If the size slide (step 2 on this page) is not set to the correct paper size, or if the paper type (page 2-12) is not set correctly, incorrect paper selection or paper misfeeding may occur.

# Loading paper in the bypass tray

The bypass tray can be used to feed regular paper or special papers. For the paper types that can be used in the bypass tray, see the specifications for the bypass tray in the paper tray specifications (page 2-9).

**Up to 250 sheets of SHARP standard paper or up to 100 postcards can be loaded in the bypass tray.**

**NOTES**

- After loading the paper in the bypass tray, be sure to set the paper type and size (step 4) if these were changed.
- Do not use inkjet paper. This may cause misfeeds in the fusing unit.

**1 Open the bypass tray.**

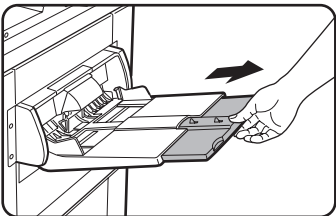
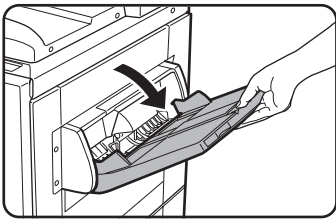

When loading paper that extends past the end of the tray, pull out the tray extension to support the paper and allow the paper sensors to properly detect the paper size.

Be sure to pull the tray extension all the way out. If the tray extension is not pulled all the way out, the size of the paper loaded in the bypass tray may not be detected correctly.

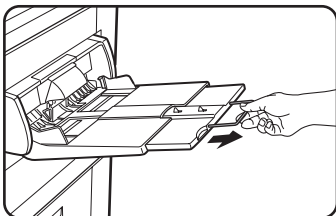

To support papers that extend past the tray extension, pull out the wire extension.

**2 Set the bypass tray guides to the width of the paper.**

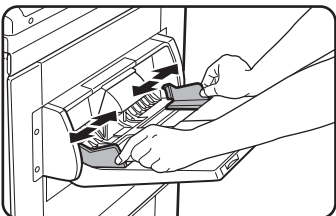

**3 Insert the paper all the way into the bypass tray. (Do not force the paper in.)**

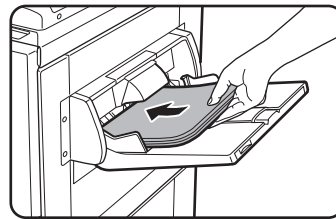

Place the paper face up. If the bypass tray guides are set wider than the paper, the inside of the machine may become soiled, resulting in smudges

on succeeding copies. Special purpose papers other than SHARP recommended transparency film must be fed individually. Multiple sheets of SHARP recommended transparency film can be loaded in the bypass tray.

**4 Set the type and size of the paper loaded in the bypass tray.**

If you loaded a different type and size of paper from the previous paper, be sure to set the new paper type and size as explained in "Setting the paper type and paper size in the bypass tray" (page 2-15).

(If you do not set a size, part or all of the image may not print.)

**5 This completes the procedure for loading paper in the bypass tray.**

**NOTE**

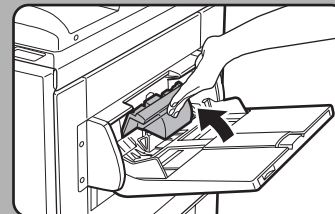

When loading paper in the bypass tray or closing the tray, close the paper cover as shown.

**NOTES**

- Be sure to load A5 paper, 5-1/2" x 8-1/2" paper, and postcards as shown in the diagram below.

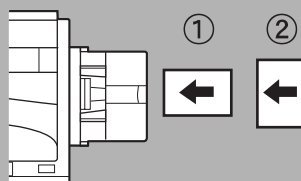

- ① Post cards.
- ② A5 paper, 5-1/2" x 8-1/2" paper.

- When loading plain paper other than paper recommended for colour or Sharp standard paper, or when loading special media other than postcards or SHARP-recommended transparency film, or when loading paper to be printed on the back, the paper must be loaded one sheet at a time. Loading more than one sheet at a time will cause misfeeds.
- Before loading heavy paper, straighten any curling in the paper.
- When adding paper, remove any paper remaining in the tray, combine it with the paper to be added, and reload as a single stack.
- Do not use paper that has already been printed on by a plain paper fax machine or a laser printer. This may cause printed images to become dirty.
- When printing on transparency film, be sure to remove each sheet as it exits the machine. Allowing sheets to stack in the output tray may cause curling.
- Use only SHARP-recommended transparency film. Insert the film so that the rounded corner is on the left for horizontal loading, or on the right for vertical loading.

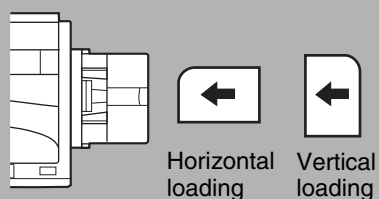

- When loading multiple sheets of transparency film in the bypass tray, fan the sheets several times before loading.

## ■ Setting envelopes or postcards

When setting envelopes or postcards in the bypass tray, set them in the orientation shown below.

### Loading postcards

Insert the postcard with the side to be printed on facing up. The postcard should be oriented as shown in the diagram.

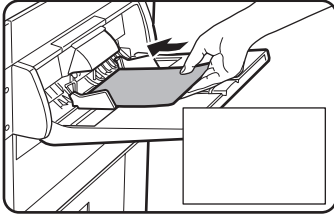

### Loading envelopes

Only the front side of envelopes can be printed on. Insert the envelope with the front side facing up.

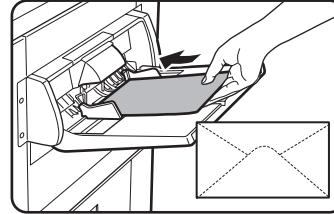

## Printing onto envelopes or postcards

- Attempting to print onto both sides of envelopes or postcards may result in misfeeds or poor prints.
- Do not use pre-printed envelopes.
- Before inserting a postcard or envelope, straighten any curled edges. Curled edges may cause creases, colour deviations, misfeeds, and poor quality images.

## Printing onto envelopes

- Attempting to print on envelopes that have metal clasps, plastic snaps, string closures, windows, linings, self-adhesive patches or synthetic materials may cause misfeeds, inadequate toner adherence or other trouble.
- Envelopes with embossed surfaces may cause the prints to become smudged.
- Under high humidity and temperature conditions the glue flaps on some envelopes may become sticky and be sealed closed when printed.
- Use only envelopes which are flat and crisply folded. Curled or poorly formed envelopes may be poorly printed or may cause misfeeds.
- Print quality is not guaranteed in the area 10 mm or 13/32" from the edges of the envelope.
- Print quality is not guaranteed on parts of envelopes where there is a large step-like change of thickness, such as on three-layer or four-layer envelopes.
- Print quality is not guaranteed on envelopes having peel off flaps for sealing the envelopes.

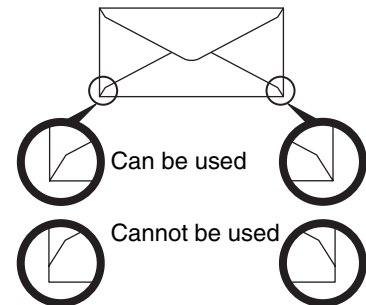

## Fusing unit pressure adjusting levers

In some cases damage to the envelopes, colour deviations, or smudging may occur even if envelopes within the specifications are used. This problem may be reduced by shifting the fusing unit pressure adjusting levers from their normal pressure position to the lower pressure position. Follow the procedure on the next page. (page 2-7)

### NOTE

Be sure to return the lever to the normal position when you have finished feeding envelopes. If not, inadequate toner adherence, paper misfeeds or other trouble may occur.



### 1 Unlatch the duplex bypass/inverter unit and slide it to the left.

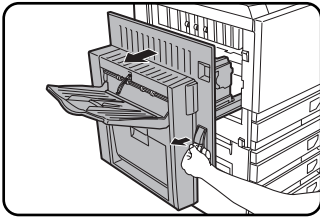

Unlatch the unit and gently move it away from the machine. If the machine is not equipped with a duplex bypass/inverter unit, open the side cover similarly.

### 3 Gently close the duplex bypass/inverter unit.

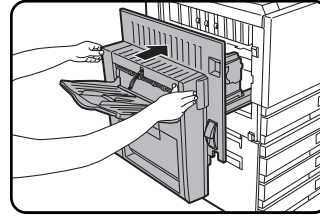

If the machine is not equipped with a duplex bypass/inverter unit, close the side cover.

### 2 Lower the two fusing unit pressure adjusting levers marked A and B in the illustration.

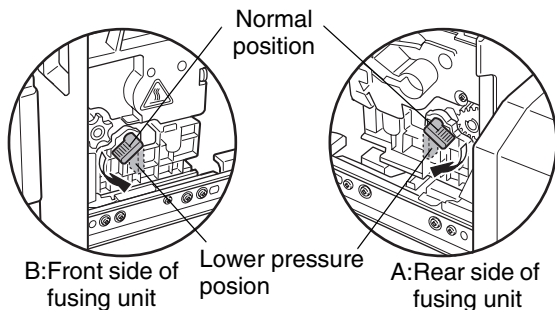
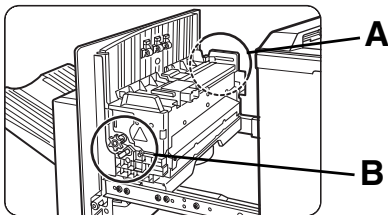

## Loading paper in the stand/1 x 500 sheet paper drawer/stand/3 x 500 sheet paper drawer

### Upper tray / middle tray / lower tray\*

Up to 500 sheets of paper recommended for colour or SHARP recommended plain paper can be loaded in these trays. The method of loading paper is the same as for paper tray 1 in the main unit (see the explanation on page 2-2).

\* The stand/1 x 500 sheet paper drawer only has the upper tray.

#### NOTE

If the size of paper being loaded is different from the previous size, or is an extra size, or if the paper type is different from the previous type, you must change the paper tray settings in the custom settings. Change the settings as explained in "Setting the paper type (except for the bypass tray)" on page 2-12 and "Specifying the size when the paper size is set to "Extra" (except for the bypass tray)" on page 2-13.

## Specifications (stand/1 x 500 sheet paper drawer/stand/3 x 500 sheet paper drawer)

Name	Stand/1 x 500 sheet paper drawer	Stand/3 x 500 sheet paper drawer
Paper size/weight	See "1-tray or 3-tray paper drawer" in the paper tray specifications (page 2-9)	
Paper capacity	Paper recommended for colour (80 g/m <sup>2</sup> or 20 lbs.): 500 sheets; SHARP standard paper (80 g/m <sup>2</sup> or 20 lbs.): 500 sheets	
Power supply	Supplied from the main unit	
Power consumption	32.2 W or less	32.7 W or less
Dimensions	600 mm (W) x 642 mm (D) x 403 mm (H) (23-5/8" (W) x 25-9/32" (D) x 15-7/8" (H)) (not including the adjuster)	
Weight	Approximately 22.5 kg or 49.5 lbs.	Approximately 29.5 kg or 64.9 lbs.

Specifications are subject to change for improvement without notice.

## Loading paper in the duplex module/2 x 500 sheet paper drawer

### Upper tray:

The upper tray contains a duplex module that automatically turns print paper over for automatic two-sided printing.

### Middle and lower paper trays:

Up to 500 sheets of paper recommended for colour or SHARP recommended plain paper can be loaded in the middle and lower trays. The method of loading paper is the same as for paper tray 1 in the main unit. See the explanation on page 2-2.

#### NOTE

If the size of paper being loaded is different from the previous size, or is an extra size, or if the paper type is different from the previous type, you must change the paper tray settings in the custom settings. Change the settings as explained in "Setting the paper type (except for the bypass tray)" on page 2-12 and "Specifying the size when the paper size is set to "Extra" (except for the bypass tray)" on page 2-13.

## Specifications (duplex module/2 x 500 sheet paper drawer)

Name	Duplex module/2 x 500 sheet paper drawer
Power supply	Supplied from the main unit
Power consumption	35.6 W or less
Dimensions	600 mm (W) x 642 mm (D) x 403 mm (H) (23-5/8" (W) x 25-9/32" (D) x 15-7/8" (H)) (not including the adjuster)
Weight	Approximately 31 kg or 68.2 lbs.
Duplex module	
Size of plain paper	A3, B4, A4, A4R, B5, B5R, A5, 11" x17", 8-1/2" x 14", 8-1/2" x 13", 8-1/2" x 11", 8-1/2" x 11"R, 7-1/4" x 10-1/2", 5-1/2" x 8-1/2"
Weight of plain paper	64 to 200g/m <sup>2</sup> or 17 to 54 lbs.
Number of sheets	One sheet (single pass type)
2 x 500 sheet paper drawer	
Paper size/weight	See "2-trays paper drawer" in the paper tray specifications (next page 2-9)
Paper capacity	Paper recommended for colour (80 g/m <sup>2</sup> or 20 lbs.): 500 sheets; SHARP standard paper (80 g/m <sup>2</sup> or 20 lbs.): 500 sheets

Specifications are subject to change for improvement without notice.

## Specifications of paper trays

The specifications for the types and sizes of paper that can be loaded in the paper trays are shown below.

	Paper tray type	Tray No. (tray name)	Applicable paper types	Applicable paper sizes	Remarks		
A	Paper tray 1	Tray 1	Paper recommended for colour	A3, B4, A4, A4R, B5, B5R, Extra (11"x17", 8-1/2"x14", 8-1/2"x13", 8-1/2"x11", 8-1/2"x11"R, 5-1/2"x8-1/2")	See "STORAGE OF SUPPLIES" on page 2-22		
			Plain paper	A3, B4, A4, A4R, B5, B5R, A5, Extra (11"x17", 8-1/2"x14", 8-1/2"x13", 8-1/2"x11", 8-1/2"x11"R, 5-1/2"x8-1/2")	See "More information on plain paper" on the next page		
B	Bypass tray	Bypass tray	Same as paper types and sizes in row A * Paper size A3W (12" x 18") can also be used in the bypass tray			See "More information on special media that can be used" on the next page	
			Special paper (Refer to the next page for applicable special papers.)	Heavy paper	Heavy 1		A5 - A3W (5-1/2"x8-1/2" - 12"x18"), Special paper (paper weight: 106 to 200 g/m <sup>2</sup> (28 to 54 lbs.)), Postcard
					Heavy 2		A5 - A3W (5-1/2"x8-1/2" - 12"x18"), Special paper (paper weight: 201 to 300 g/m <sup>2</sup> (54 to 80 lbs.))
				Transparency film			Transparency S, Transparency Q
	Envelopes		●Standard-size envelopes that can be used :COM10,Monarch,DL,C5				
C	Stand/1 x 500 sheet paper drawer	Tray 2	Same as paper types and sizes in row A				
D	Stand/3 x 500 sheet paper drawer	Upper				Tray 2	
		Middle				Tray 3	
		Lower	Tray 4				
E	Duplex module/2 x 500 sheet paper drawer	Upper	Duplex	Duplex module (See page 2-8 for paper sizes and weights that can be used.)			
		Middle	Tray 2	Same as paper types and sizes in row A			
		Lower	Tray 3				

■ **More information on plain paper**

The following restrictions apply to plain paper. Be sure to load the paper correctly. Incorrect loading may result in skewed feeding or misfeeds.

		Paper in AB system	Paper in inch system
		A5 - A3W	5-1/2"x8-1/2" - 12"x18"
Plain paper	SHARP standard paper	80g/m <sup>2</sup>	20 lbs.
	Restrictions on paper other than SHARP standard paper	64 to 105g/m <sup>2</sup> or 17 to 28 lbs.	
Recycled, colour, pre-punched, pre-printed and letter head papers must conform to the same conditions as above.			

■ **More information on special media that can be used**

The following restrictions apply to special media. The use of incorrect media may result in fusing problems (weak adhesion of toner to paper or toner smudging when rubbed), skewed feeding, misfeeds, or other failures.

		Type	Remarks
Special paper	Heavy paper	heavy 1	<b>For paper sizes from A5 to A3W (5-1/2" x 8-1/2" to 12" x 18"), paper weights from 106 to 200 g/m<sup>2</sup> (28 to 54 lbs.) can be used.</b> ● Postcards can be used. Do not use folded postcards, picture postcards, or postcards with a coated front. These may cause misfeeds or a dirty printed image.
		heavy 2	<b>For paper sizes from A5 to A3W (5-1/2" x 8-1/2" to 12" x 18"), paper weights from 201 to 300 g/m<sup>2</sup> (54 to 80 lbs.) can be used.</b>
	Transparency film		Use SHARP recommended transparencies.
	Envelopes		Applicable standard envelopes: COM-10, Monarch, DL, C5 Envelopes can only be fed from the Bypass tray. Applicable paper stock weight for envelopes is 75 to 90 g/m <sup>2</sup> or 20 to 23 lbs.

- Special paper such as heavy 2, transparency film, and envelopes cannot be output to the centre tray.
- Paper that cannot be output to the centre tray is output face-up to the left tray.

■ **Paper that can be used for automatic two-sided printing**

Paper used for automatic two-sided printing (paper that can be fed through the duplex module) must meet the following conditions:

- Paper type : Plain paper as specified above.
- Paper size : Must be one of the following standard sizes: A3, B4, A4, A4R, B5, B5R or A5 (11" x 17", 8-1/2" x 14", 8-1/2" x 13", 8-1/2" x 11", 8-1/2" x 11"R, 7-1/4" x 10-1/2" or 5-1/2" x 8-1/2")
- Paper weight : 64 to 200 g/m<sup>2</sup> or 17 to 54 lbs.

**NOTE**

Special papers as described above cannot be used for two-sided printing. Heavy paper up to 200 g/m<sup>2</sup> (54 lbs.) can be used.

## Structure of the tray setting menu (except for the bypass tray)

"TRAY SETTING" is the first setting in "CUSTOM SETTINGS" (see page 2-18).

"TRAY SETTING" consists of the levels shown below.

To move through the settings on any level, press the [▼] key or [▲] key.

To select a setting or store a selection for a setting, press the [OK] key.

To move back to the previous level after completing a setting or to cancel selection of a setting, press the [BACK/C] key.

To correct an accidental selection, press the [BACK/C] key.

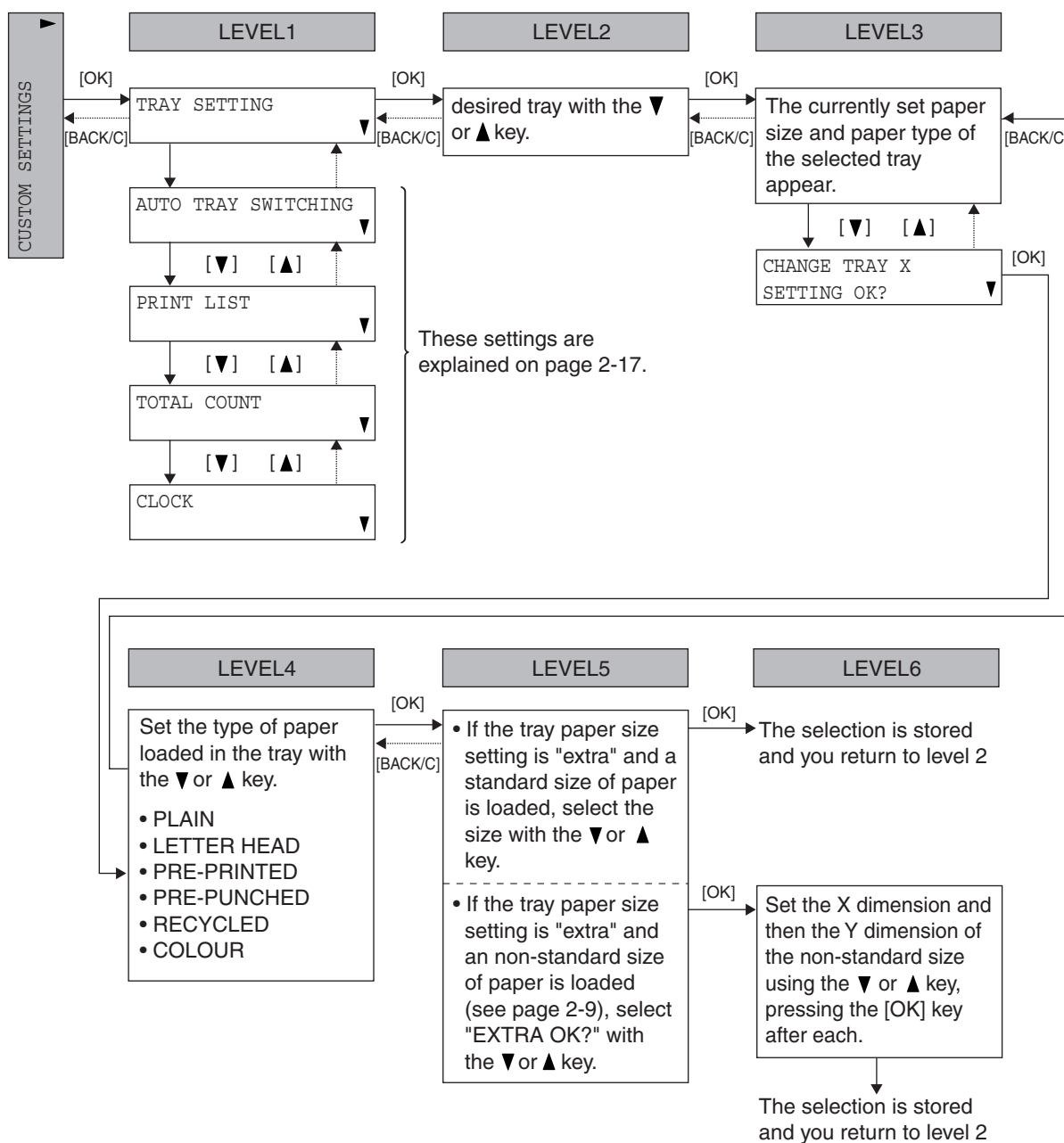

## Setting the paper type (except for the bypass tray)

Follow these steps to change the paper type setting when the paper type has been changed in a paper tray. When a paper tray is set to "Extra", see the explanation on the following page.

For the paper types that can be used in each tray, see page 2-9. To change the paper type setting for the bypass tray, see pages 2-14 to 2-16.

- 1** Press the [MENU] key repeatedly until "CUSTOM SETTINGS" appears in the message display.

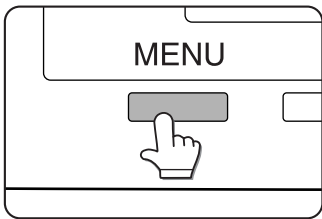

- 2** Press the [OK] key.

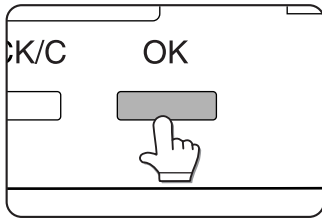

"TRAY SETTING" will appear in the message display.

- 3** Press the [OK] key.



The message at left will appear in the message display.

- 4** Select the desired paper tray.

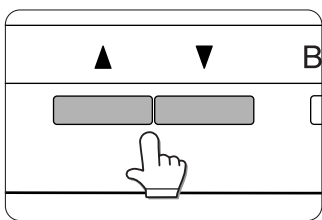

Press the ▲ or ▼ key repeatedly until the desired paper tray appears in the display. To check which tray number corresponds to which actual tray, see page 2-2.



- 5** Press the [OK] key.



The paper size and paper type of the tray selected in step 4 will appear.

- 6** Press the ▼ key.



- 7** Press the [OK] key.

To cancel, press the [BACK/C] key and return to step 4.

- 8** Select the type of paper that is loaded in the tray.



Press the ▲ or ▼ key repeatedly until the paper type appears.

The paper type selections are as follows:

"PLAIN", "LETTER HEAD", "PRE-PRINTED", "PRE-PUNCHED", "RECYCLED", "COLOUR"

### NOTE

Special paper such as heavy paper, transparency film, and postcards can be selected for the bypass tray.

- 9** Press the [OK] key.

If the selected paper tray is a large capacity tray, the setting will be completed without the paper size appearing.



● The display at left appears in the factory default state.

● In the factory default state, the display shows "EXTRA". Once a paper size is set in step 7 on the following page, that paper size will appear.

● When using a non-standard size of paper, see the explanation on the following page.

- 10** If "EXTRA" appears in the display in step 9, press the [OK] key 3 times.

If a size other than "EXTRA" appears in the display in step 9, press the [OK] key once.

- 11** Press the [MENU] key to complete the setting.

## Specifying the size when the paper size is set to "Extra" (except for the bypass tray)

When the size slide on a paper tray is set to "extra", follow the steps below to specify the paper size.

For example, if 8-1/2" x 11" size paper is loaded in the tray (with the size slide set to "extra"), use this procedure to set the "extra" paper size to 8-1/2" x 11" size. If you loaded a non-standard size of paper, you can enter the dimensions of the paper.

To set the paper size when an extra size of paper is loaded in the bypass tray, see page 2-15.

**1** Perform steps 1 through 8 of "Setting the paper type (except for the bypass tray)" on the previous page.

**2** Press the [OK] key.

EXTRA  
OK?

The display at left appears in the factory default state.

(The currently set paper size of the selected paper tray will appear.)

**3** Press the ▲ key or ▼ key until the appropriate paper size appears. If a non-standard size of paper is loaded, press the ▲ key or ▼ key until "EXTRA OK?" appears.

### Example 1

To select 8-1/2" x 11" size on an AB-based model, press the ▲ or ▼ key until the following display appears.

LETTER  
OK?

### Example 2

To select a special size, press the ▲ or ▼ key until the following display appears.

EXTRA  
OK?

**4** Press the [OK] key.

- If you selected a size other than "EXTRA OK?" in step 3 (such as "LETTER OK?" in the above example), go to step 7.
- If you selected "EXTRA OK?" in step 3, go to step 5.

**5** Press (or hold down) the ▲ or ▼ key to set the X dimension and press the [OK] key.

PAPER SIZE SETTING  
X:139mm\*▼

An asterisk "\*" appearing next to a number indicates that

the number is the currently set dimension (for example, 139\*).

The permitted range for the X dimension is 139 to 432 mm (5-1/2 to 17 inches).

**6** Press (or hold down) the ▲ or ▼ key to set the Y dimension.

PAPER SIZE SETTING  
Y:100mm\*▼

An asterisk "\*" appearing next to a number indicates that

the number is the currently set dimension (for example, 100\*).

The permitted range for the Y dimension is 100 to 297 mm (4 to 11-3/4 inches).

**7** Press the [OK] key.

**8** Press the [MENU] key to complete the setting.

## Structure of the bypass tray setting menu

"BYPASS TRAY PAPER SELECTION" consists of the levels shown below.

To move through the settings on any level, press the [▼] key or [▲] key.

To select a setting or store a selection for a setting, press the [OK] key.

To move back to the previous level after completing a setting or to cancel the selection of a setting, press the [BACK/C] key.

To correct an accidental selection, press the [BACK/C] key.

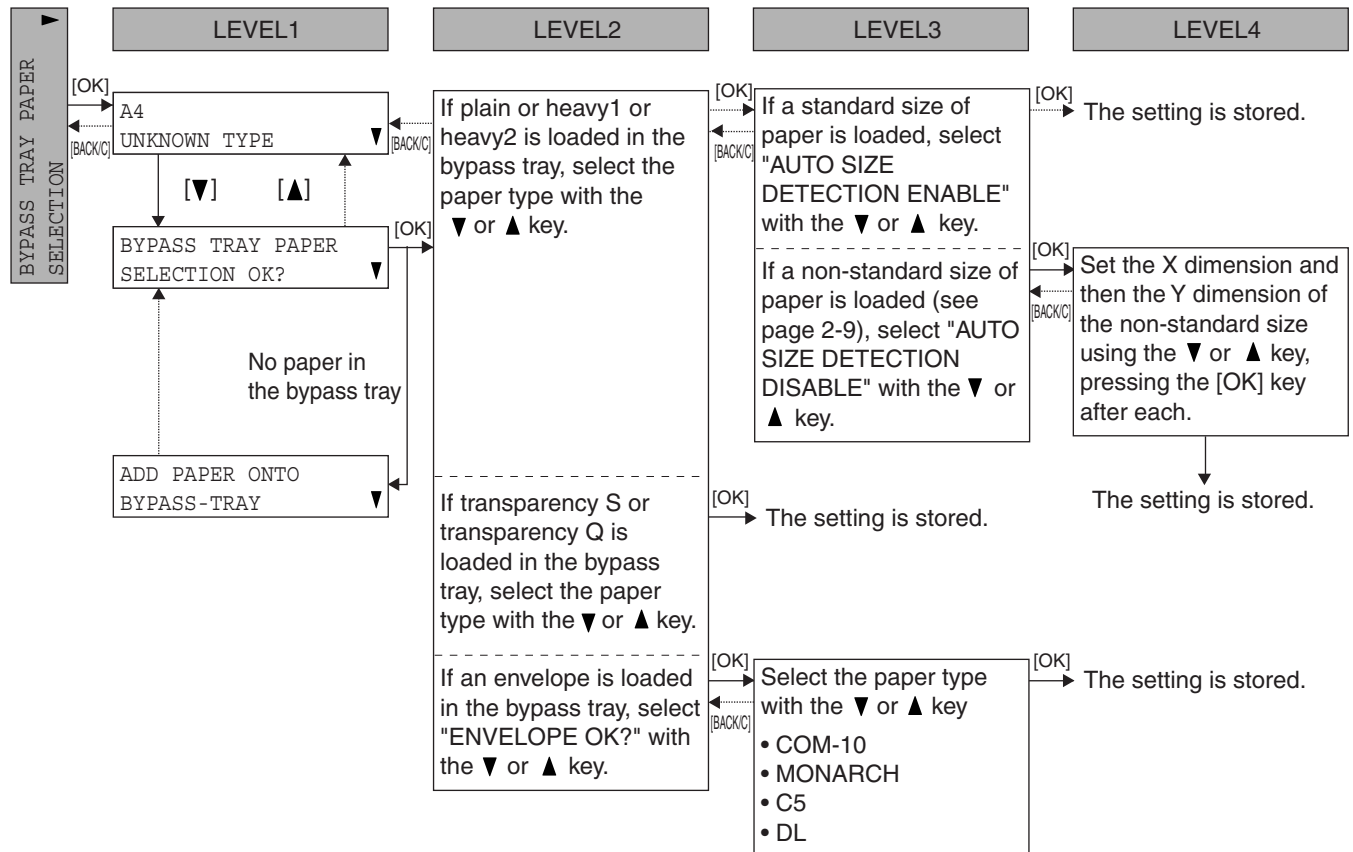

If the type of the paper loaded in the bypass tray is either plain, letter head, pre-printed, pre-punched, recycled or colour, select "PLAIN" for the bypass tray paper type in LEVEL2 operation.



## Setting the paper type and paper size in the bypass tray

Follow the steps below to set the type and size of the paper loaded in the bypass tray.  
Load the paper in the bypass tray before performing these steps.

- 1** Press the [MENU] key repeatedly until "BYPASS TRAY PAPER SELECTION" appears in the message display.

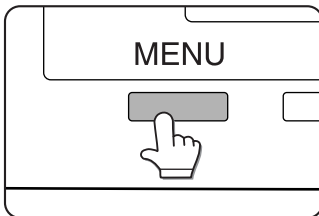

- 2** Press the [OK] key.

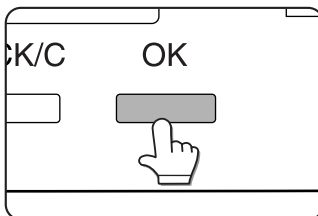

The current paper size and type settings are displayed. (If the current settings are correct, press the [BACK/C] key to exit.)

- 3** Press the [▼] key.

BYPASS TRAY PAPER SELECTION OK? ▼

The message at left will appear.

- 4** Press the [OK] key.

If paper has not been loaded in the bypass tray, "ADD PAPER ONTO BYPASS-TRAY" will appear then load the paper and press the [OK] key again.

- 5** Select the appropriate paper type.

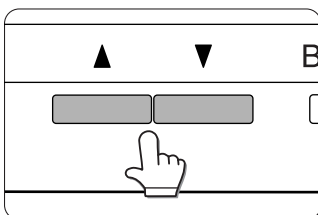

Press the ▲ or ▼ key repeatedly until the appropriate paper type appears.

- The paper type selections are as follows:  
"PLAIN", "HEAVY1", "HEAVY2",  
"TRANSPARENCY S", "TRANSPARENCY Q",  
"ENVELOPE"
- If heavy paper is loaded, select [HEAVY1] or [HEAVY2]. For the types of heavy paper that can be used, see page 2-10.
  - If transparency film is loaded, select [TRANSPARENCY S] or [TRANSPARENCY Q]. [TRANSPARENCY S] is for fast printing, while [TRANSPARENCY Q] is for a high quality image.

- 6** The steps that follow differ depending on the paper type selected the step 5. Follow the steps for the selected type.

- If you selected [PLAIN], [HEAVY1] or [HEAVY2], go to step 7 to 12.
- If you selected [TRANSPARENCY S] or [TRANSPARENCY Q], go to step 13.
- If you selected [ENVELOPE], go to step 14 to 15.

- 7** Press the [OK] key.

AUTO SIZE DETECTION ENABLE\*▼

If you loaded a standard size of paper, make sure that "AUTO

SIZE DETECTION ENABLE" appears and then press the [OK] key. This completes the setting.

If you loaded a non-standard size of paper go to step 8. (next step)

- 8** Press the ▲ or ▼ key until "AUTO SIZE DETECTION DISABLE" appears.

AUTO SIZE DETECTION DISABLE\*▼

- 9** Press the [OK] key.

You will now set the X dimension and then the Y dimension of the loaded paper.

- 10** Press (or hold down) the ▲ or ▼ key to set the X dimension and then press the [OK] key.

PAPER SIZE SETTING X:139mm\*▼

An asterisk "\*" appearing next to a number indicates that

the number is the currently set dimension (for example, 139\*).

The permitted range for the X dimension is 139 to 432 mm (5-1/2 to 17 inches).

- 11** Press (or hold down) the ▲ or ▼ key to set the Y dimension.

PAPER SIZE SETTING Y:100mm\*▼

An asterisk "\*" appearing next to a number indicates that

the number is the currently set dimension (for example, 100\*).

The permitted range for the Y dimension is 100 to 297 mm (4 to 11-3/4 inches).

**12** Press the [OK] key. This completes the setting.

**13** Press the [OK] key. This completes the setting.

**14** Press the [OK] key.

COM-10 OK? ▼
-----------------

Press the ▲ or ▼ key repeatedly until the appropriate envelope type appears.

Envelope type selections are as follows:

"COM-10", "MONARCH", "C5", "DL"

**15** Press the [OK] key. This completes the setting.

# CUSTOM SETTINGS

The custom settings allow you to set the following parameters.

- Tray settings ..... Paper type and paper size\* settings for each tray (see pages 2-11 and 2-14).  
\*The paper size setting is only used when a tray's paper size slide is set to "EXTRA". Be sure to set the paper type.
- Auto tray switching ..... This setting enables automatic switching between trays loaded with the same type and size of paper. If one tray runs out of paper during printing, printing will continue from the other tray. (See page 2-19)
- Print list ..... Used to print a list of machine settings. (See page 2-19)
- Total count ..... The number of pages printed by the machine and optional equipment can be displayed. (See page 2-19.)
- Clock ..... Used to set the date and time of the printer's built-in clock. (See page 2-19)

## Basic procedure for custom settings

**1** Press the [MENU] key repeatedly until "CUSTOM SETTINGS" appears.

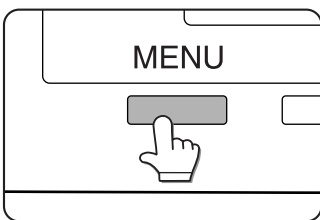

Any print jobs held in the printer and any jobs currently being transmitted to the printer will be printed using the previous custom settings.

**2** Press the [OK] key.

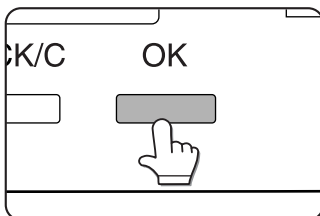

**3** Press the ▲ or ▼ key to select the desired setting.

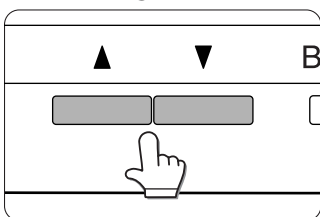

**4** Press the [OK] key.

**5** Press the ▲ or ▼ key until the desired selection for the setting appears.

For information on the selections for each setting, see the explanations on page 2-19 and following.

**6** Press the [OK] key.

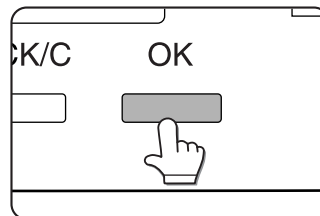

"\*" will appear to the right of the selection and the selection will be stored. Some settings may require the configuration of additional parameters.

In this case, press the ▲ or ▼ until the desired selection for the parameter appears and then press the [OK] key to store it. To configure another custom setting, press the [BACK/C] key and repeat steps 5 and 6.

**7** When you have finished configuring the settings, press the [MENU] key to return to the initial screen.

### NOTE

The [BACK/C] key can be used to move back to the previous setting level. This is useful if you accidentally select the wrong setting.

# Structure of the custom settings menu

The "CUSTOM SETTINGS" are arranged as shown below.

Press the ▲ key or ▼ key to move through the settings in any level of the menu.

To select a setting or store a selection for setting, press the [OK] key.

To move back to the previous level after completing a setting or to cancel the selection of a setting, press the [BACK/C] key.

[C] may appear in a display message. This indicates the [BACK/C] key.

To correct an accidental selection, press the [BACK/C] key.

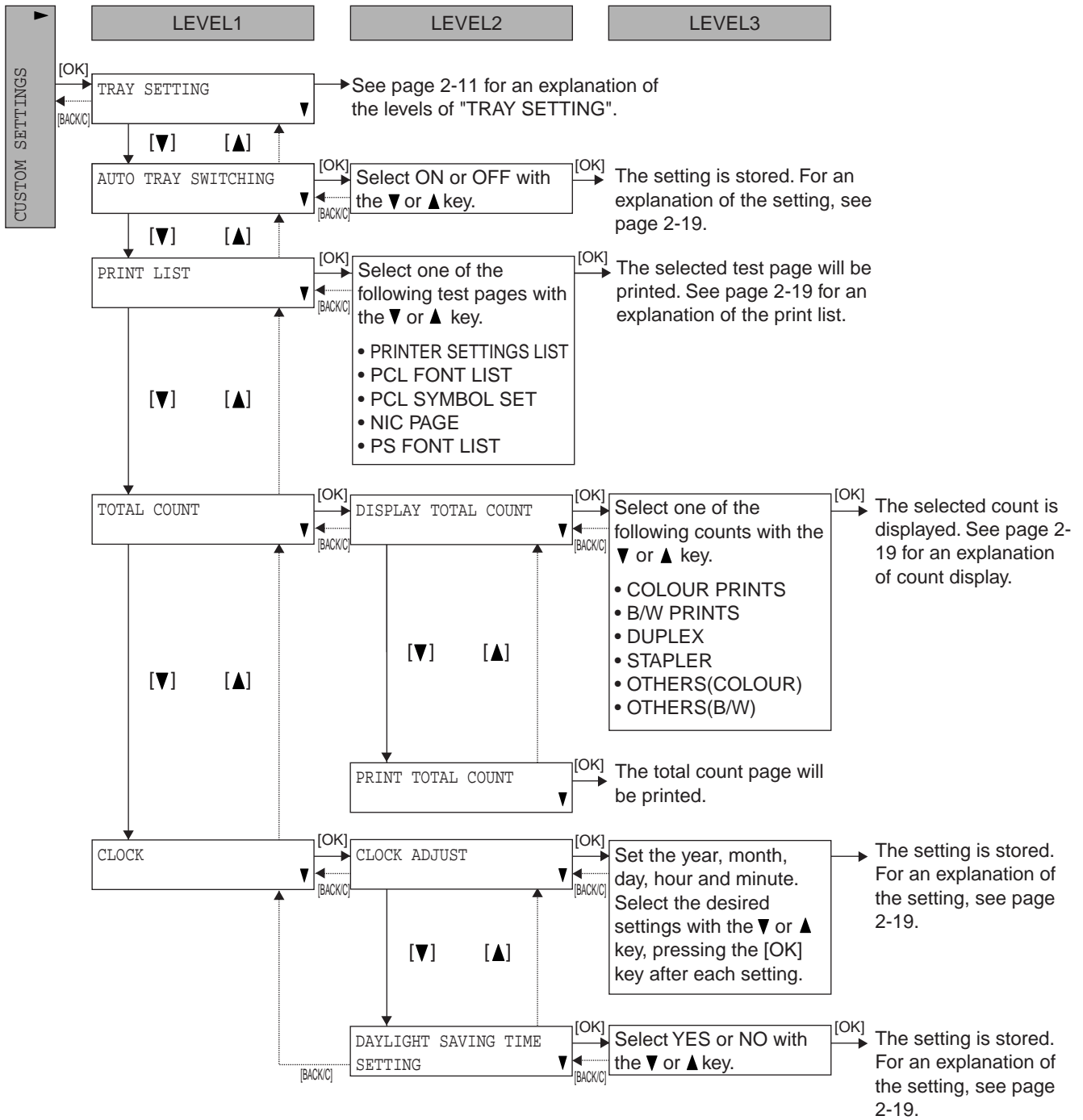

## Setting items

### ■ Tray settings

These settings are used to set the type of paper used in each tray. For trays in which the paper size slide is set to "EXTRA", these settings are also used to specify the paper size. These settings are explained in detail in "Setting the paper type (except for the bypass tray)" on page 2-12 and "Specifying the size when the paper size is set to "Extra" (except for the bypass tray)" on page 2-13.

### ■ Auto tray switching

This setting is used to enable automatic switching between trays loaded with the same type and size of paper. If one tray runs out of paper during printing, printing will continue from the other tray.

### ■ Print list

#### Printer setting list

- This is used to print out a list of the machine settings.
- This shows the operation condition settings and custom settings. The key operator program settings are not shown.

**PCL font list:** List of fonts that can be used with the PCL printer drivers.

**PCL symbol set:** List of PCL symbols.

**NIC page:** List of NIC (Network Interface Card) settings.

**PS font list:** List of fonts that can be used with the PostScript printer driver.

### ■ Total count

The total number of pages printed can be displayed and printed for each of the following types of prints.

"COLOUR PRINTS", "B/W PRINTS", "DUPLEX",  
"STAPLER", "OTHERS(COLOUR)",  
"OTHERS(B/W)"

The counts that can be displayed and printed will vary depending on the peripheral devices that are installed.

### ■ Clock

#### Clock adjust

Use this setting to adjust the date and time of the machine's built-in clock. The date and time are used in functions that require date and time information.

#### Daylight saving time setting

Use this setting to enable automatic adjustment of the clock at the beginning and end of daylight savings time.

#### NOTE

If list page printing is disabled with the "DISABLE TEST PAGE PRINTING" key operator program (page 20 of the Key Operator's Guide), the menu "Print List" does not appear.

# REPLACING THE TONER CARTRIDGES

When toner runs low, "TONER IS LOW □□□□" appears in the display. It is recommended that you keep a set of new toner cartridges so that you can replace them quickly when toner runs out.

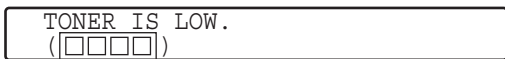

If you continue to use the toner cartridge, the toner will eventually run out, the machine will stop and the following message will appear.



This indicates the colour of toner that is low.  
 Y = Yellow toner  
 M = Magenta toner  
 C = Cyan toner  
 K = Black toner

## NOTES

- There may be cases that print images become light or uneven before the message is displayed, depending on the way the machine is used. If this occurs, take out the toner cartridge by following the same steps as replacement, shake it horizontally to even out the toner in the cartridge, and re-insert the toner cartridge. If print images do not improve even after following this procedure, replace the toner cartridge with a new cartridge.
- If one of the toners is out, including black toner, colour printing will not be possible. If Y, M, or C runs out but K toner remains, black and white printing will still be possible.

Follow these steps to replace the toner cartridge that is out of toner.

### 1 Open the front cover.

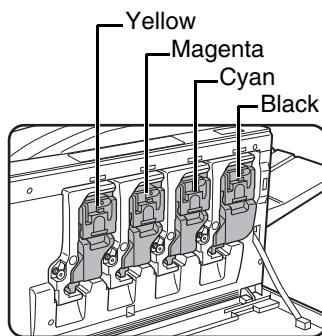
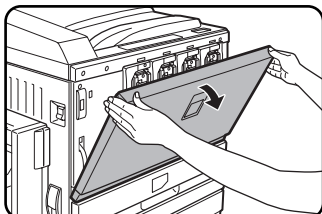

Arrangement of colour toner cartridges

### 3 While holding the lock lever on the toner cartridge, pull the toner cartridge toward you.

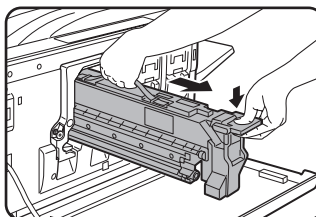
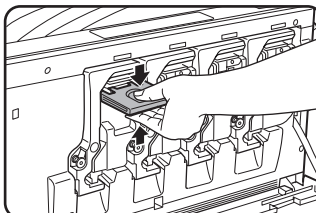

Hold the toner cartridge with both hands as shown in the illustration, and pull it out of the machine.

### 2 Lift the cartridge lock lever toward you.

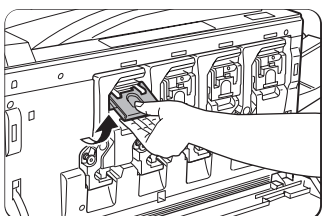

Example: Replacing the yellow toner cartridge

### 4 Remove a new toner cartridge from the package and shake it horizontally five or six times.

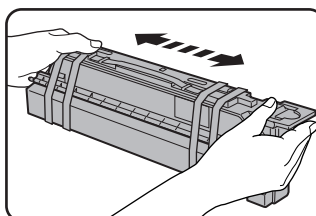

**5** Remove the protective material from the new toner cartridge.

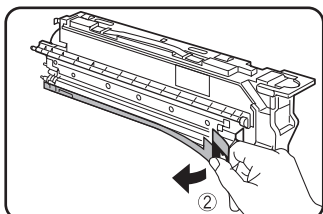
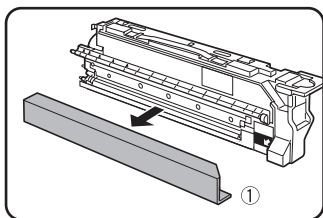

**6** Insert the new toner cartridge.

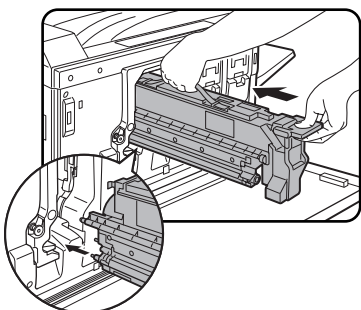

Align the insert holes as shown and then push the cartridge in.

**NOTE**

A toner cartridge of a different colour cannot be installed. For instance, a yellow cartridge cannot be installed in the cyan position.

**7** Push the cartridge in until it locks securely in place.

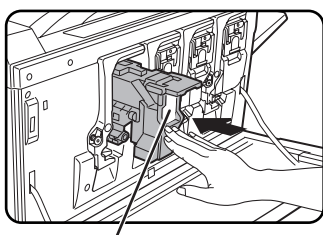

**NOTE**

Do not push the white area shown in the illustration. The lock lever may come down.

**8** Return the cartridge lock lever.

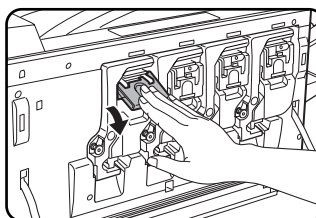

**9** Close the front cover.

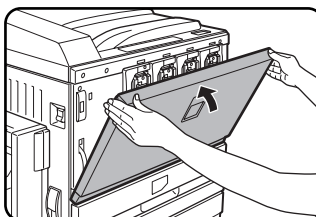

After the toner cartridge is replaced, the machine automatically enters resolution adjustment mode. (In some cases, this may take 1 to 5 minutes.)

**2**

**CAUTION**

- Do not throw the toner cartridge into a fire. Toner may fly and cause burns.
- Store toner cartridges out of the reach of small children.

# STORAGE OF SUPPLIES

Standard supplies for this product that can be replaced by the user include paper, toner cartridges, and staple cartridges for the finisher.

**SHARP**

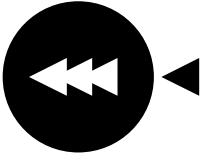

For best printing results, be sure to use only Sharp Genuine Supplies which are designed, engineered, and tested to maximize the life and performance of Sharp products. Look for the Genuine Supplies label on the toner package.

**GENUINE SUPPLIES**

## ■ Proper storage

1. Store the supplies in a location that is:
  - clean and dry,
  - at a stable temperature,
  - not exposed to direct sunlight.
2. Store paper in the wrapper and lying flat.
  - Paper stored standing up or out of the wrapper may curl or become damp, resulting in paper misfeeds.

# CLEANING THE CABINET

Wipe the printer cabinet with a soft, clean cloth.

## **NOTE**

If necessary, dampen the cloth with water. Do not use thinner, benzene, or similar volatile cleaning agents. Do not spray flammable cleaner gas.



# MISFEED REMOVAL

When a misfeed has occurred, printing will stop and the message shown below will appear. Follow the procedure below to remove misfed paper.

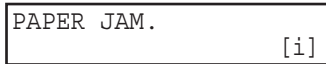

## General misfeed removal procedure

When a misfeed occurs, follow these steps to check the number that indicates the general location of the misfeed. The numbers and their corresponding locations are shown in the table below. The numbers and locations are also shown in the illustration on the inside of the front cover.

### 1 Press the INFORMATION key.

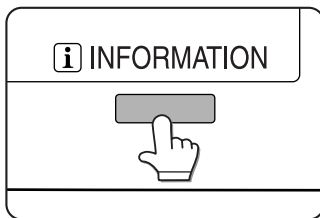

### 2 Press the ▼ key twice.

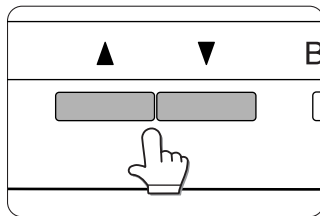

Use the ▲ or ▼ keys to scroll through the guidance messages.

Display example

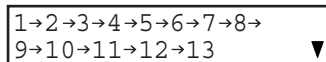

For the location that the number indicates, see the illustration on the inside of the front cover.

The procedures for removing misfeeds from each location are explained on the pages indicated below.

Number	Location	Page
1, 2	For misfeeds in large capacity tray	5-11
3, 5	<ul style="list-style-type: none"> <li>Misfeed in the transport area</li> <li>Misfeed in the 500 sheet paper drawer</li> <li>Misfeed in the stand/1 x 500 sheet paper drawer or the stand/3 x 500 sheet paper drawer</li> </ul>	2-25 2-24 2-26
4	Misfeed in the bypass tray	2-24
6, 7, 8	Misfeed in the fusing area, and exit area	2-25
9	Misfeed in the saddle stitch finisher	5-7
10, 11, 12	Misfeed in the duplex bypass/inverter unit	2-27
13	Misfeed in the duplex module/2 x 500 sheet paper drawer	2-27

### 3 Press the INFORMATION key to close the misfeed removal guidance.

#### NOTES

- Be careful not to tear the misfed paper during removal.
- If paper is accidentally torn during removal, be sure to remove all pieces.
- Take care not to damage or leave fingerprints on the transfer belt when removing the misfed paper.

#### CAUTION

The fusing unit is hot. Take care in removing paper.

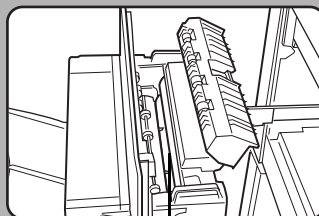

Upper fusing unit

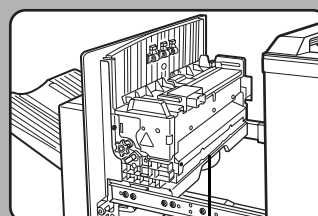

Fusing unit paper guide

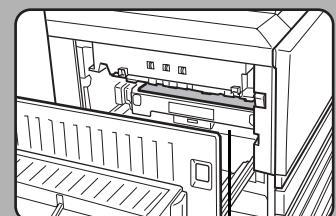

Transfer belt

# Misfeed in the paper feed area

**NOTE**

Paper misfed from a paper tray may be extending out of the tray into the right side cover area. If the tray is drawn out of the machine in this case, the paper may tear and become difficult to remove. To prevent this from happening, always open the right side cover first and remove the misfed paper if it is extending into that area.

## Misfeed in the 500 sheet paper drawer

**1** Open the upper side cover.

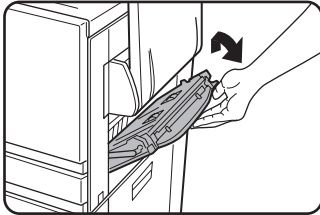

Push the blue lever upward and gently open the cover.

**5** Gently close the upper side cover.

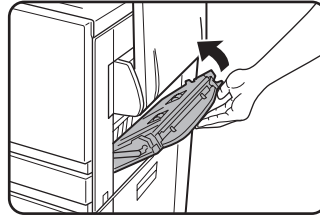

After closing, confirm that the misfeed message has been cleared and the normal display appears.

**NOTE**

If paper is loaded in the bypass tray, remove the paper and close the bypass tray before opening the side cover.

**2** Remove the misfed paper.

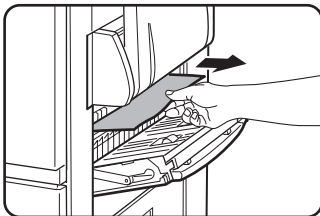

Be careful not to tear the misfed paper during removal.

## Misfeed in the bypass tray

**1** Remove the misfed paper from the bypass tray.

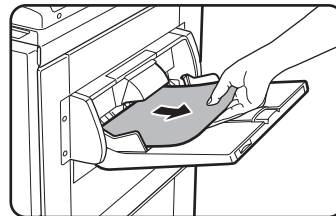

Be careful not to tear the misfed paper during removal.

**NOTE**

The misfeed may have occurred inside the machine. Check carefully and remove it.

**3** If misfed paper is not found in step 2, pull out paper tray 1 and remove the misfed paper.

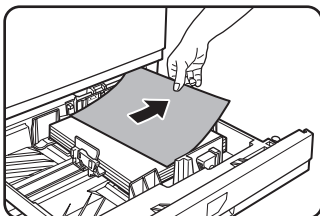

Be careful not to tear the misfed paper during removal.

**2** After removing the misfed paper, open and close the duplex bypass/inverter unit to reset.

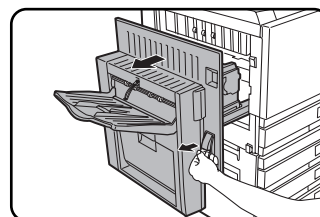

Grasp the finger hold and gently open the unit.

**4** Gently close the paper tray.

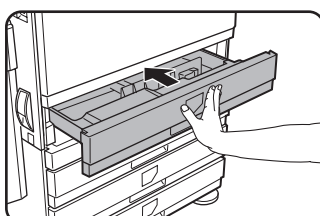

Push the tray firmly all the way into the machine.

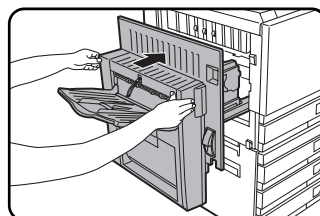

After closing, confirm that the misfeed message has been cleared and the normal display appears. If the duplex bypass/inverter unit is not installed, close the side cover in the same way.

# Misfeed in the transport area, fusing area, and exit area

## Transport area

**1** Open the upper side cover and check for a misfeed.

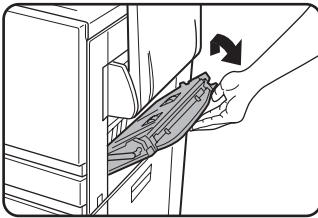

① Push the blue lever upward and gently open the cover.

### NOTE

If paper is loaded in the bypass tray, remove the paper and close the bypass tray before opening the side cover.

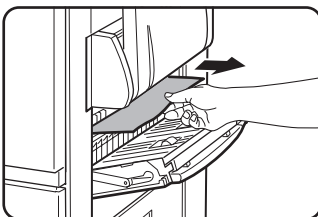

② Be careful not to tear the misfed paper during removal.

### NOTE

The misfeed may have occurred inside the machine. Check carefully and remove it.

**2** Gently close the upper side cover.

### NOTE

Even after clearing a misfeed, paper may remain inside the machine on the transfer belt where it is not visible. In this case, after visible misfeeds are removed, the paper on the transfer belt will be automatically moved to a position where it is visible and a misfeed will be indicated once again on the display. Clear the misfeed as explained in "Misfeed in the transfer unit" (step 3 on the right side of this page). For this reason, it may be necessary to perform the "Misfeed in the transfer unit" procedure twice.

## Exit area

**1** Misfeed in the exit area

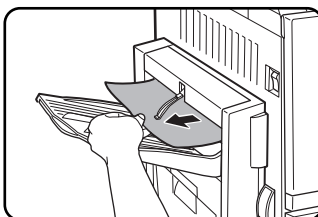

**Models with an exit tray attached to the duplex bypass/inverter unit:**

Gently remove the misfed paper as shown in the illustration, taking care not to tear the paper.

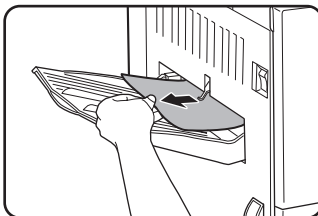

**Models without the duplex bypass/inverter unit:**

Gently remove the misfed paper as shown in the illustration, taking care not to tear the paper.

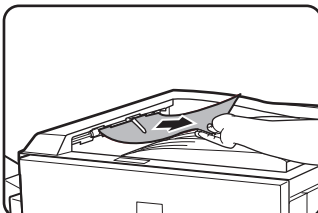

**Centre exit tray:**

Gently remove the misfed paper as shown in the illustration, taking care not to tear the paper.

## Fusing area

**1** Open the duplex bypass/inverter unit.

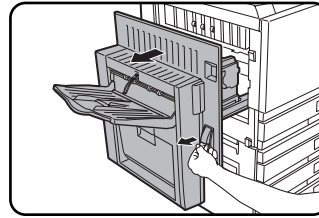

Grasp the finger hold and gently open the unit.

**2** Remove the misfed paper as shown in the illustrations below.

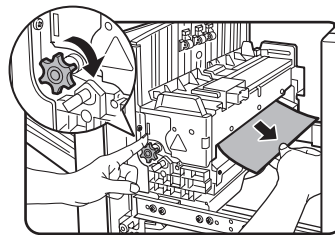

If paper is misfed in the transport area, turn roller knob A in the direction of the arrow to remove the misfed paper.

### CAUTION

The fusing unit is hot. Take care in removing paper. (Do not touch any metal parts.)

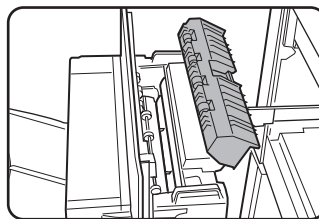

If you do not find a misfeed, open the cover of the fusing unit and check for a misfeed inside the fusing unit.

### CAUTION

The fusing unit is hot. Take care in removing paper. (Do not touch any metal parts.)

**3** Misfeed in the transfer unit

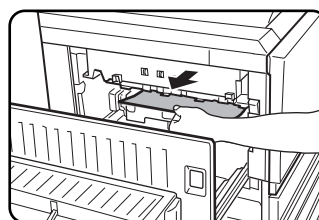

If paper is misfed on the transfer belt, remove it gently without touching the transfer belt. Do not pull out the transfer unit.

### CAUTION

The transfer unit is hot. Take care in removing paper. (Do not touch any metal parts.)

**4** Gently close the duplex bypass/inverter unit.

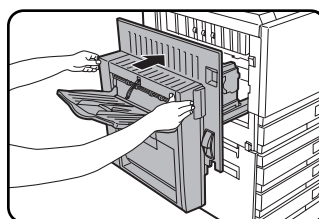

After closing, confirm that the misfeed message has been cleared and the normal display appears. If the duplex bypass/inverter unit is not installed, close the side cover in the same way.

2

## Misfeed in the stand/1 x 500 sheet paper drawer

**NOTE**

Paper misfed from a paper tray may be extending out of the tray into the right side cover area. If the tray is drawn out of the machine in this case, the paper may tear and become difficult to remove. To prevent this from happening, always open the right side cover first and remove the misfed paper if it is extending into that area.

**1 Open the upper and lower side covers.**

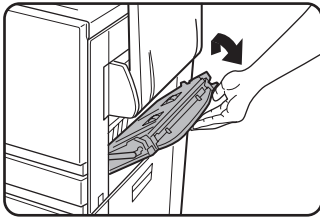

Push the blue lever upward and gently open the cover.

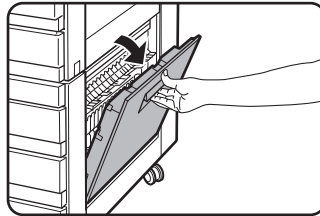

**NOTE**

If paper is loaded in the bypass tray, remove the paper and close the bypass tray before opening the side cover.

**2 Remove the misfed paper.**

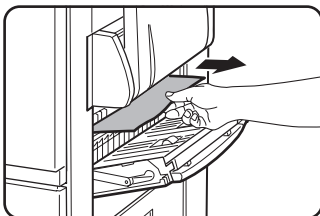

Be careful not to tear the misfed paper during removal.

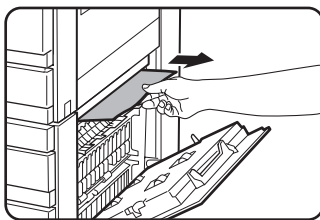

**NOTE**

The misfeed may have occurred inside the machine. Check carefully and remove it.

**3 If misfed paper is not found in step 2, pull out paper tray 1 and remove the misfed paper.**

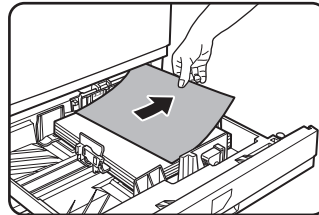

Be careful not to tear the misfed paper during removal.

**4 Gently push the paper tray into the machine.**

Push the tray firmly all the way into the machine.

**5 Gently close the upper and lower side covers.**

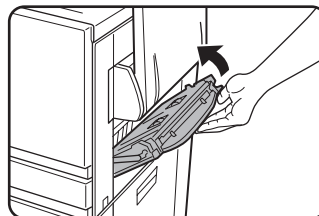

After closing, confirm that the misfeed message has been cleared and the normal display appears.

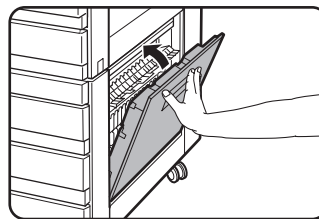

## Misfeed in the stand/3 x 500 sheet paper drawer

To remove a misfeed in the upper, middle, or lower tray, follow steps 1 through 5 above of "Misfeed in the stand/1 x 500 sheet paper drawer".

# Misfeed in the duplex bypass/inverter unit and duplex module/2 x 500 sheet paper drawer

## NOTE

Paper misfed from a paper tray may be extending out of the tray into the right side cover area. If the tray is drawn out of the machine in this case, the paper may tear and become difficult to remove. To prevent this from happening, always open the right side cover first and remove the misfed paper if it is extending into that area.

**1** Perform steps 1 and 2 of "Misfeed in the stand/1 x 500 sheet paper drawer" on the previous page.

**2** Open the upper cover of the duplex bypass/inverter unit.

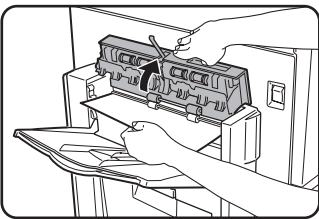

**3** Remove the misfed from the upper part of the duplex bypass/inverter unit.

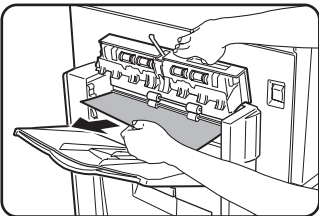

Hold the upper cover of the unit open while removing the misfed paper.

**4** Close the upper cover of the duplex bypass/inverter unit.

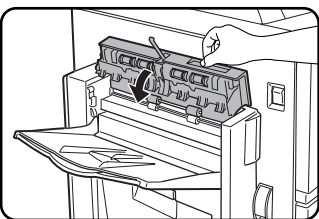

**5** Lift the exit tray if installed and open the cover of the duplex bypass/inverter unit.

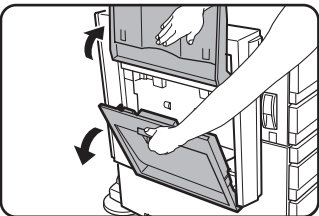

**6** Remove the misfed paper.

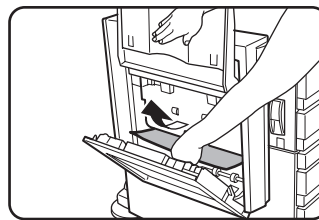

While holding the exit tray up, remove the misfed paper as shown in the illustration. Be careful not to tear the misfed paper during removal.

**7** Close the cover of the duplex bypass/inverter unit and return the exit tray to its original position.

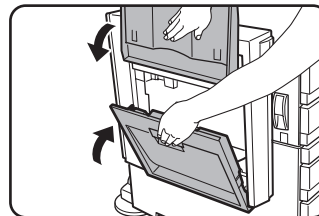

**8** Remove the misfed paper from the bottom of the duplex bypass/inverter unit.

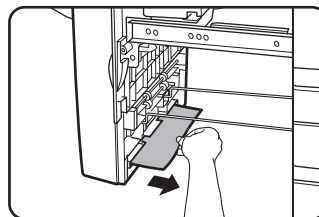

Gently remove the misfed paper from the bottom of the duplex bypass/inverter unit as shown in the illustration, taking care not to tear the paper.

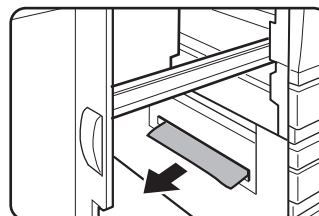

Make sure that there is no misfed paper in the machine.

**9** Pull out the duplex module of the duplex module/2 x 500 sheet paper drawer.

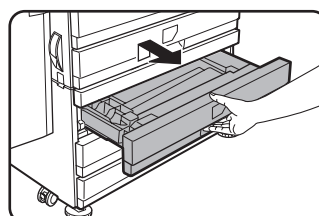

**10** Remove the misfed paper from the duplex module.

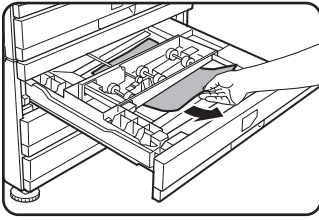

Be careful not to tear the misfed paper during removal.

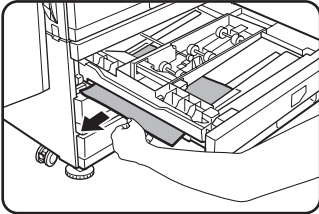

**11** Gently close the duplex module.

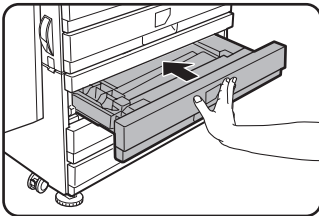

Push the tray firmly all the way into the machine.

**12** Gently close the duplex bypass /inverter unit.

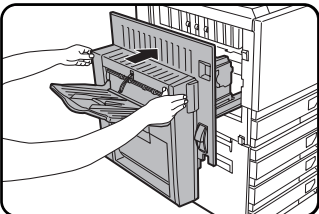

■ **Misfeed in the upper or lower tray**

To remove misfed paper from the upper tray or lower tray, follow steps 1 through 5 of "Misfeed in the stand/1 x 500 sheet paper drawer" on page 2-26.

# TROUBLESHOOTING

Problems related to general functions of the machine are described in this section. For printing and saddle stitch finisher problems, see chapter 4 of the "Operation manual (for printer)" (this is provided as a PDF file in the CD-ROM that accompanies the AR-C260P). The Operation manual (for printer) and the Key operator's guide are provided as PDF files in the CD-ROM that accompanies the AR-C260P. Problems are not always due to machine failure and in many cases can be easily resolved by following the solutions in the table below. If it is determined that service is required, turn the power switch off, unplug the power cord and request service.

- If the message "CALL FOR SERVICE. CODE:\*\*-\*\*" appears in the message display, turn off the main switch, wait about 10 seconds, and then turn the main switch back on. If the message still appears after turning the switch off and on several times, it is likely that a failure has occurred that requires service. In this event, stop using the machine, unplug the power cord, and contact your Sharp dealer.

Note: Letters and numbers appear in "\*\*-\*\*" above. When you contact your Sharp dealer, please tell your dealer what letters and numbers appear.

- When the message "MAINTENANCE" appears in the message display, service by an authorised Sharp Service Technician will be required soon. Contact your Sharp dealer as soon as possible.

Problem	Check	Solution or cause
The machine does not operate.	Printer plugged in?	Plug the printer into a grounded outlet.
	Main power switch on?	Turn on the main power switch.
	READY indicator off?	The printer is warming up. (Warm-up time is approximately 99 seconds.) Wait until the READY indicator lights up.
	Message indicating need to load paper displayed?	Load paper. (page 2-2)
	Message indicating need to replace the toner cartridge displayed?	Replace the toner cartridge.(page 2-20)
	Message indicating a paper misfeed displayed?	Remove misfed paper. (page 2-23)
Incorrect bypass tray paper size	Incorrect display of paper sizes A3W, A3, B4, A4R, 12" x 18", 11" x 17", 8-1/2" x 14", 8-1/2" x 13", or 8-1/2" x 11"R only.	When loading sizes A3W, A3, B4, A4R, 12" x 18", 11" x 17", 8-1/2" x 14", 8-1/2" x 13", or 8-1/2" x 11"R, be sure to open the tray extension.
Printing on paper from the bypass tray is skewed	The number of sheets placed on the bypass tray exceeds the maximum number.	Do not place more than the maximum number of sheets.
	The bypass guide is not adjusted to the size of the loaded paper.	Adjust the bypass guide to the size of the loaded paper.
Paper from the bypass tray misfeeds	The paper size and paper type have not been set.	Be sure to set the paper size and paper type when using special size or special type papers. (pages 2-14 to 2-16)
	The number of sheets placed on the bypass tray exceeds the maximum number.	Do not place more than the maximum number of sheets.
	The bypass guide is not adjusted to the size of the loaded paper.	Adjust the bypass guide to the size of the loaded paper.
Printing stops before the job is finished	If too many pages collect on the output tray, the tray full sensor activates and stops printing.	Remove the paper from the output tray.
	The tray is out of paper.	Load paper. (page 2-2)

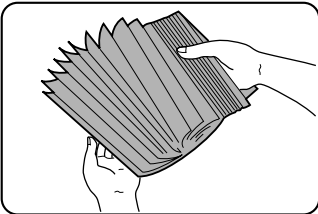
Problem	Check	Solution or cause
Smudges on printed sheets	Does a message appear indicating the need for maintenance?	Please contact your dealer as soon as possible.
Colour deviations occur.	When printing in colour, text and colour deviations appear.	Perform colour registration as explained on pages 9 and 10 of the key operator's guide.
The displayed paper size differs from the loaded paper size.	The tray's paper size slide is not set to the correct size for the paper in the tray.	When you change the paper size in the tray, be sure to adjust the paper size slide on the tray to the new paper size. (page 2-3)
When printing on an "extra" size of paper, part of the printed image is missing.	The paper size slide in the tray is set to "extra", however, the correct paper size is not specified in the paper tray settings of the custom settings.	Specify the correct paper size in the paper tray settings of the custom settings (see pages 2-12 to 2-13). If the paper size setting is not correct, part or all of the image may not print (this depends on the options installed).
When printing on a non-standard size of paper using the bypass tray, part of the printed image is missing.	The paper size setting for the bypass tray is not correct.	Set the correct paper size as explained on pages 2-14 to 2-16. If the paper size setting is not correct, part or all of the image may not print (this depends on the options installed).
Paper misfeeds frequently.	Is paper other than SHARP-recommended paper being used?	Use SHARP-recommended paper. (pages 2-10 and 2-22)
	Paper curled or damp?	Do not use curled or crimped paper. If you are not going to use paper for a long time, store the paper in the wrapper in a dry location.
	Is the paper curled and does it frequently misfeed in the duplex module/2 x 500 sheet paper drawer or saddle stitch finisher?	Some types of paper may curl inside the machine. Turning the paper over in the tray may help reduce misfeeding due to curling.
	Multiple sheets of paper fed simultaneously?	 <p>Remove the paper from the paper tray or the bypass tray, fan the paper as shown in the illustration, and then load it again.</p>
Printed paper is wrinkled or the image rubs off easily.	Is paper other than SHARP-recommended paper being used?	Use SHARP-recommended paper. (pages 2-10 and 2-22)
	Is paper size or weight outside of the permitted range?	Use paper in the permitted range.
	Do wrinkles appear when printing envelopes?	Moving the pressure adjusting levers of the fusing unit from the normal position to a weaker pressure position may help alleviate this problem. (page 2-6)
	Is the pressure adjustment lever of the fusing unit out of position?	Return the pressure adjusting levers of the fusing unit to the normal position. (page 2-7)
	Paper damp?	Be sure to store paper in the wrapper in a dry location. Do not store paper in a location that is: <ul style="list-style-type: none"> <li>● humid</li> <li>● extremely hot or cold.</li> </ul>





# CHAPTER 3

---

## OPERATION CONDITION SETTINGS

---

This chapter explains the operation condition settings.

	Page
CONFIGURING THE OPERATION CONDITION SETTINGS .....	3-2
• Basic procedure for operation condition settings (settings that can be configured from the operation panel) .....	3-2
• Structure of the operation conditions menu .....	3-3
• Default settings .....	3-4
• PCL settings .....	3-5
• Print PS errors .....	3-6

# CONFIGURING THE OPERATION CONDITION SETTINGS

The operation condition settings are used to configure basic printing settings. The following settings are available.

- **DEFAULT SETTINGS**.....Basic settings used in printing (page 3-4)
- **PCL SETTINGS** ..... Sets the PCL symbol set and fonts (page 3-5)
- **Print PS errors\*** ..... Sets whether a PostScript error page is printed or not when a PostScript error has occurred. (page 3-6)

\* An optional PS3 expansion kit is needed.

## Basic procedure for operation condition settings (settings that can be configured from the operation panel)

- 1** Press the [MENU] key repeatedly until "SET OPERATING CONDITIONS" appears.

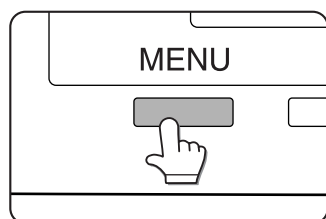

Any print jobs held in the printer and any jobs currently being transmitted to the printer will be printed using the previous operation condition settings.

- 2** Press the [OK] key.

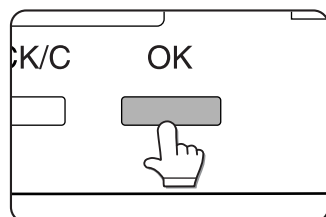

- 3** Press the ▲ or ▼ key until the desired setting appears.

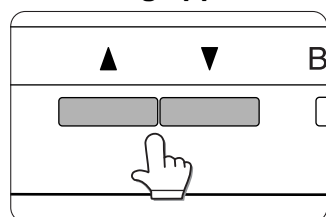

- 4** Press the [OK] key.

- 5** Press the ▲ or ▼ key until the desired selection for the setting appears.

For information on the selections for each setting, see the explanations on page 3-3 and following.

- 6** Press the [OK] key.

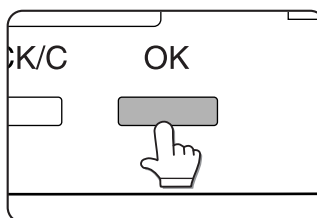

"\*" will appear to the right of the selection and the selection will be stored. To configure another setting, press the [BACK/C] key to return to step 3 and repeat the procedure through step 6.

- 7** When you have finished configuring the settings, press the [MENU] key to return to the initial screen.

### NOTE

The [BACK/C] key can be used to move back to the previous setting level. This is useful if you accidentally select the wrong setting.

## Structure of the operation conditions menu

The settings under "SET OPERATING CONDITIONS" are arranged as shown below.

Press the [▼] key or [▲] key to move through the settings in any level of the menu.

To select a setting or store a selection for setting, press the [OK] key.

To move back to the previous level after completing a setting or to cancel the selection of a setting, press the [BACK/C] key.

To correct an accidental selection, press the [BACK/C] key.

After the [OK] key is pressed to store a setting, an asterisk "\*" will appear next to the setting.

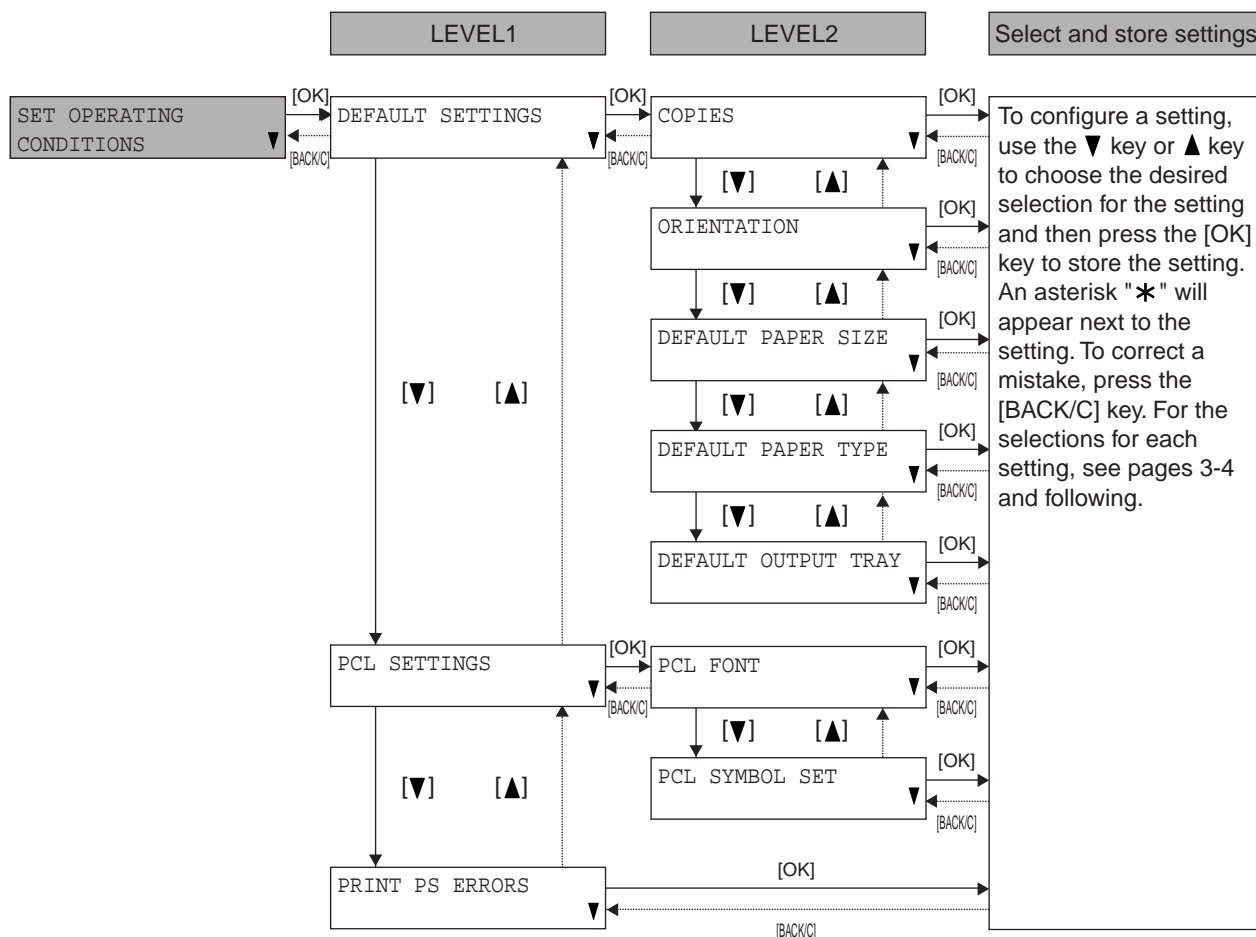

## Default settings

The default settings are used to set conditions for printing in an environment where the print driver is not used (such as printing from MS-DOS or from a computer that does not have the provided print driver installed).

### NOTE

When a setting can be configured both in the printer driver and on the operation panel, the setting in the printer driver overrides the setting on the operation panel. For this reason, settings in the printer driver should always be configured in the printer driver, not on the operation panel.

The following settings are available:

### ■ Copies

This sets the number of copies of each page.

Default setting: 1

The number of copies can be set from 1 to 999.

### ■ Orientation

The image can be printed in portrait orientation or landscape orientation.

Default setting: PORTRAIT

Selections: PORTRAIT, LANDSCAPE

### ■ Default paper size

This sets the paper size to be used for printing if a paper size is not otherwise selected.

Default setting: A4 or LETTER

Selections: A3W, A3, B4, A4, B5, A5, LETTER, LEDGER, LEGAL, FOLSCAP, EXECUTIVE, INVOICE

### ■ Default paper type

This sets the paper type to be used for printing if a paper type is not otherwise selected.

Default setting: PLAIN

PLAIN, LETTER HEAD, PRE-PRINTED, PRE-PUNCHED, RECYCLED, COLOUR

### ■ Default output tray

This sets the output tray to be used for printing if an output tray is not otherwise selected in the application software.

Default setting: CENTRE TRAY

The trays that can be selected depend on the peripheral devices that are installed.

## PCL settings

### ■ PCL font

This setting is used to select the font for printing.

Default setting: "Courier"

You can print the "PCL FONT LIST" in "PRINT LIST" (see page 2-19) .

Font name	LCD display	Font name	LCD display
Courier	Courier	Helvetica Narrow Bold	Helvetica NB
CG Times	CG Times	Helvetica Narrow Oblique	Helvetica NO
CG Times Bold	CG Times B	Helvetica Narrow Bold Oblique	Helvetica NBO
CG Times Italic	CG Times I	Palatino Roman	Palatino R
CG Times Bold Italic	CG Times BI	Palatino Bold	Palatino B
CG Omega	CG Omega	Palatino Italic	Palatino I
CG Omega Bold	CG Omega B	Palatino Bold Italic	Palatino BI
CG Omega Italic	CG Omega I	ITC Avant Garde Gothic Book	ITC AG Gothic B
CG Omega Bold Italic	CG Omega BI	ITC Avant Garde Gothic Demi	ITC AG Gothic D
Coronet	Coronet	ITC Avant Garde Gothic Book Oblique	ITC AG Gothic BO
Clarendon Condensed	Clarendon C	ITC Avant Garde Gothic Demi Oblique	ITC AG Gothic DO
Univers Medium	Univers M	ITC Bookman Light	ITC Bookman L
Univers Bold	Univers B	ITC Bookman Demi	ITC Bookman D
Univers Medium Italic	Univers MI	ITC Bookman Light Italic	ITC Bookman LI
Univers Bold Italic	Univers BI	ITC Bookman Demi Italic	ITC Bookman DI
Univers Medium Condensed	Univers MC	New Century Schoolbook Roman	New Century SB R
Univers Bold Condensed	Univers BC	New Century Schoolbook Bold	New Century SB B
Univers Medium Condensed Italic	Univers MCI	New Century Schoolbook Italic	New Century SB I
Univers Bold Condensed Italic	Univers BCI	New Century Schoolbook Bold Italic	New Century SB BI
Antique Olive	Antique Olive	Times Roman	Times R
Antique Olive Bold	Antique Olive B	Times Bold	Times B
Antique Olive Italic	Antique Olive I	Times Italic	Times I
Garamond Antiqua	Garamond A	Times Bold Italic	Times BI
Garamond Halbfett	Garamond H	ITC Zapf Chancery Medium Italic	ITC ZC MI
Garamond Kursiv	Garamond K	Symbol	Symbol
Garamond Kursiv Halbfett	Garamond KH	SymbolPS	SymbolPS
Marigold	Marigold	Wingdings	Wingdings
Albertus Medium	Albertus M	ITC Zapf Dingbats	ITC ZD
Albertus Extra Bold	Albertus EB	Courier Bold	Courier B
Arial	Arial	Courier Italic	Courier I
Arial Bold	Arial B	Courier Bold Italic	Courier BI
Arial Italic	Arial I	Letter Gothic	Letter Gothic
Arial Bold Italic	Arial BI	Letter Gothic Bold	Letter Gothic B
Times New	Times New	Letter Gothic Italic	Letter Gothic I
Times New Bold	Times New B	CourierPS	CourierPS
Times New Italic	Times New I	CourierPS Bold	CourierPS B
Times New Bold Italic	Times New BI	CourierPS Oblique	CourierPS O
Helvetica	Helvetica	CourierPS Bold Oblique	CourierPS BO
Helvetica Bold	Helvetica B	Line Printer	Line Printer
Helvetica Oblique	Helvetica O	HGMINCHO H	HG MINCHO H
Helvetica Bold Oblique	Helvetica BO	HG GOTHIC G	HG GOTHIC G
Helvetica Narrow	Helvetica N		

**■ PCL symbol set**

This setting is used to select which country's characters are used for certain of the symbols in the character code table of the PCL symbol set. (Use this setting when you need to select symbols that differ by country.)

Default setting: "PC-8"

You can also print the "PCL SYMBOL SET LIST" in "PRINT LIST" (see page 2-19) .

Symbol	LCD display (9 characters maximum)	Symbol	LCD display (9 characters maximum)
Roman-8	Roman8	Math-8	Math-8
ISO 8859-1 Latin 1	ISOLatin1	PS Math	PS Math
PC-8	PC-8	Pi Font	Pi font
PC-8 Danish/Norwegian	PC-8 D/N	ISO 8859-2 Latin 2	ISOLatin2
PC-850	PC-850	ISO 8859-9 Latin 5	ISOLatin5
ISO 6 ASCII	ISO 6	ISO 8859-10 Latin 6	ISOLatin6
Legal	Legal	PC-852	PC-852
ISO 21 German	ISO 21	PC-775	PC-775
ISO 17 Spanish	ISO 17	PC Turkish	PC Turk.
ISO 69 French	ISO 69	MC Text	MC Text
ISO 15 Italian	ISO 15	Windows 3.1 Latin 1	W3.1Lat1
ISO 60 Norwegian v1	ISO 60	Windows 3.1 Latin 2	W3.1Lat2
ISO 4 United Kingdom	ISO 4	Windows 3.1 Latin 5	W3.1Lat5
ISO 11 Swedish:names	ISO 11	Windows Baltic (not 3.1)	WinBaltic
PC-1004 (OS/2)	PC1004	Windows 3.0 Latin 1	W3Latin1
DeskTop	DeskTop	Symbol	Symbol
PS Text	PS Text	Wingdings	Wingdings
Microsoft Publishing	MS Publ.	Windows3.1J	Win3.1J

These symbol sets are trademarks or registered trademarks of their respective owners.

**Print PS errors**

When a PostScript error occurs, this setting specifies whether or not an error page describing the cause of the error is printed.

Default setting: off



# CHAPTER 4

---

## PRINTING FROM THE OPERATION PANEL

---

This chapter explains how to print and delete jobs that are held in the machine using the job hold function.

	Page
HOLD JOB LIST .....	4-2

# HOLD JOB LIST

When sending a print job to the machine from your computer, you can select the "Hold After Print", "Hold Before Print" or "Proof Print" option. When one of these options is selected, the machine will hold the print job. To print or delete a hold job, use the operation panel of the machine as explained below. A maximum of 100 jobs can be held. Print jobs held by this function will not be erased even if the main switch is turned off.

If the number of jobs exceeds 100, the job is processed as follows:

- If Hold After Print is executed:  
Printing will be executed but the job will not be held. (A notice page will be printed. See page 4-6 of the Operation manual (for printer).)
- If Hold Before Print is executed:  
Printing will not be executed and the job will not be held. (A notice page will be printed. See page 4-6 of the Operation manual (for printer).)
- If Proof Print is executed:  
Printing of one set will be executed but the job will not be held. (A notice page will be printed. See page 4-6 of the Operation manual (for printer).)

If one of the above situations occurs and the Printer Status Monitor has been installed, an error message will appear on the PC monitor.

## 1 Press the [MENU] key.

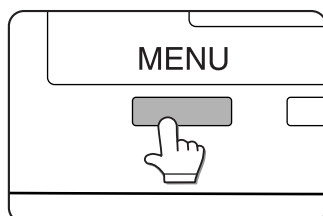

"PRINT JOBS ON HOLD" will appear in the message display.

## 2 Press the [OK] key.

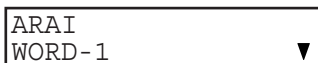
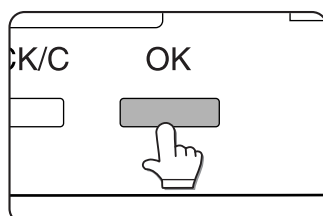

The user name and application name of the first hold job will appear.

## 3 Select the desired job.

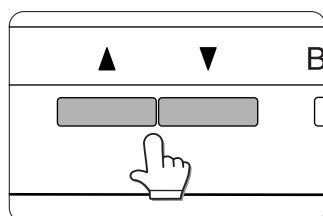

Press the ▲ or ▼ key on the operation panel repeatedly until the desired print job is displayed.

## 4 Press the [OK] key.

## 5 If a PIN number must be entered, press the ▲ or ▼ key repeatedly until the first digit of the PIN appears, and then press the [OK] key.

Be sure to enter the same PIN number that was entered on the computer. If a PIN number was not set, skip steps 5 and 6 and go directly to step 7.

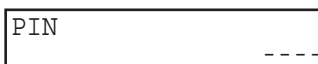

When you press the [OK] key to store the first digit after entering it, "\*" will appear and "-" in the second digit will blink. If you need to correct the previous digit, press the [BACK/C] key to move back.

### NOTE:

The password is entered one digit at a time. Digits not yet entered are shown as "-".

## 6 Repeat step 5 to enter the second through the fifth digits of the PIN number.

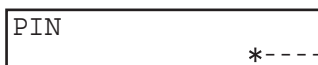



## 7 Select print and delete, print and save, or delete, and then press the [OK] key.

Press the ▲ or ▼ key until the desired choice appears.

PRINT AND DELETE THE  
DATA-OK? ▼

The job will be deleted after printing.

PRINT AND SAVE THE  
DATA-OK? ▼

The job will be held after printing.

DELETE THE DATA-OK? ▼

The job will be deleted without printing. (When this is selected, steps 8 and 9 are not needed.)

## 8 Verify that the desired number of copies is set.

COPIES  
10SET

The number of copies can be changed with the ▲ or ▼ key.

## 9 Press the [OK] key.

Printing will start. If another job is already being printed, your job will be printed after the preceding jobs and other waiting jobs are completed.



# CHAPTER 5

---

## PERIPHERAL DEVICES

---

This chapter explains the features and handling of the Saddle Stitch Finisher (AR-F13) and the Large Capacity Tray (AR-LC5N).

	Page
SADDLE STITCH FINISHER .....	5-2
• Part names .....	5-2
• Specifications .....	5-2
• Staple cartridge replacement and staple jam removal .....	5-4
• Misfeed in the saddle stitch finisher .....	5-7
LARGE CAPACITY TRAY .....	5-9
• Part name .....	5-9
• Specifications .....	5-9
• Loading paper .....	5-10
• Misfeed removal .....	5-11

# SADDLE STITCH FINISHER

The saddle stitch finisher can automatically place two staples for centreline binding of prints and fold them along the centreline. An optional hole punching unit is available for installation into the finisher.

For information on using the saddle stitch finisher, see page 1-10 of the Operation manual (for printer).

## Part names

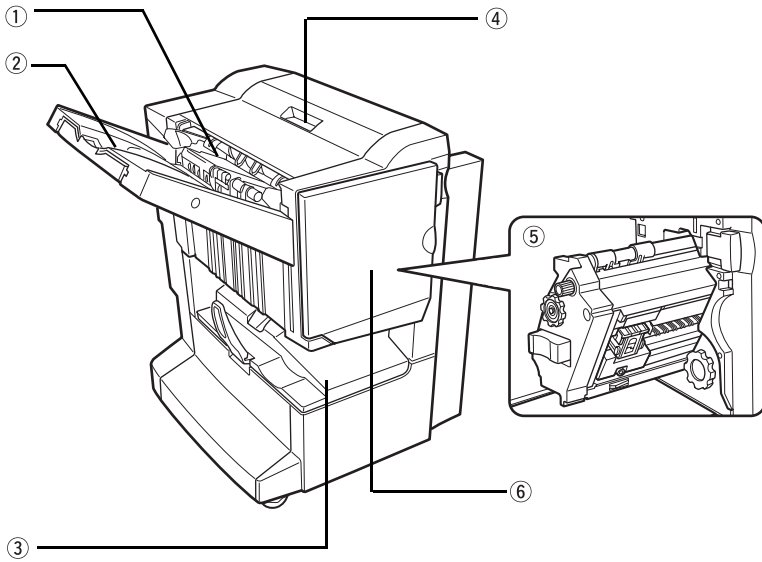

- ① **Stapler compiler**  
Paper to be stapled is stacked here temporarily. When printing on post cards or envelopes, the output is delivered here.
- ② **Offset tray**  
Stapled or offset output is delivered to this tray.
- ③ **Saddle stitch tray**  
Saddle stitched output is delivered to this tray.
- ④ **Top cover**  
Open to remove a misfeed.
- ⑤ **Stapler section**  
Open the front cover and pull out this section to replace the staple cartridge or to remove jammed staples.
- ⑥ **Front cover**  
Open to replace the staple cartridge, remove misfed paper, or remove jammed staples.

### NOTES

- Do not press on the saddle stitch finisher (particularly the offset tray).
- Use caution when near the offset tray during printing as the tray moves up and down.
- To install the saddle stitch finisher, a duplex bypass/inverter unit must be installed along with a stand/1 x 500 sheet paper drawer, or a stand/3 x 500 sheet paper drawer, or a duplex module/2 x 500 sheet paper drawer.

## Specifications

Name	Saddle stitch finisher
Number of trays	2
Tray system	Upper tray: offset tray, Lower tray: saddle stitch tray
Paper output	Upper tray: Supports both face up and face down output Lower tray: Face down output
Paper capacity	<p>Upper paper tray:</p> <p>Non-stapling: 1000 sheets of paper: A4, B5, or 8-1/2" x 11" (80 g/m<sup>2</sup> or 20 lbs.) 500 sheets of paper: Sizes other than A4, B5, or 8-1/2" x 11" (up to 10 envelopes or postcards inside the staple compiler; alignment is not guaranteed)</p> <p>Stapling: Maximum of 30 sets or 1000 sheets of A4, B5, or 8-1/2" x 11", paper (50 sets maximum for vertically fed paper stapled at one location in the upper left corner). Maximum of 30 sets or 500 sheets of other paper sizes.</p> <p>Lower tray: Stapled print capacity is (6 - 10) sheets x 10 sets or (1 - 5) sheets x 20 sets.</p>

(Continued on next page)

Paper size	Upper paper tray: Face up output: Same as paper specifications of the machine Face down output: A3W, A3, B4, A4, A4R, B5, B5R, A5, 12" x 18", 11" x 17", 8-1/2" x 14", 8-1/2" x 13", 8-1/2" x 11", 8-1/2" x 11"R, 7-1/4" x 10-1/2"R, 5-1/2" x 8-1/2" Lower tray: A3, B4, A4R, 11" x 17", 8-1/2" x 11"R
Page weight	Upper tray: 64 to 300 g/m <sup>2</sup> or 17 to 80 lbs. for face up output 64 to 200 g/m <sup>2</sup> or 17 to 54 lbs. for face down output Lower tray 64 to 105 g/m <sup>2</sup> or 17 to 28 lbs.
Paper types	Upper tray: Same as paper specifications of the machine Lower tray: Plain paper only
Paper full detection	Both upper and lower tray
Offset function	Upper tray only (offset function not possible for A5R and 5-1/2" x 8-1/2"R size paper)
Allowed paper sizes for stapling	Upper tray: A3, B4, A4, A4R, B5, 11" x 17", 8-1/2" x 14", 8-1/2" x 13", 8-1/2" x 11", 8-1/2" x 11"R Lower tray: A3, B4, A4R, 11" x 17", 8-1/2" x 11"R
Maximum number of sheets for stapling	See page 2-4 of the Operation manual (for printer)
Stapling positions	Upper tray: 3 locations (1 position back, 1 position front, 2 positions centre) Lower tray: 120 mm (4-47/64") pitch from centre of paper
Paper conveying	Centre reference
Power supply	Supplied from the machine (Stand / paper drawer)
Dimensions	633mm(W) x 603mm(D) x 771mm(H) (24-59/64" (W) x 23-3/4" (D) x 30-23/64" (H))
Weight	Approximately 36kg (79.4lbs.)

Name	Punch module			
Model*1	AR-PN1A	AR-PN1B*2	AR-PN1C*3	AR-PN1D*3
Number of holes	2	3 or 2	4	4
Paper sizes for hole punching	A3, B4, A4, A4R, B5, B5R, 11" x 17", 8-1/2" x 14", 8-1/2" x 11", 8-1/2" x 11"R	3 holes: A3, A4, 11" x 17", 8-1/2" x 11" 2 holes: 8-1/2" x 14", 8-1/2" x 11"R	A3, A4	A3, B4, A4, A4R, B5, B5R, 11" x 17", 8-1/2" x 14", 8-1/2" x 11", 8-1/2" x 11"R

\*1 Multiple punch modules cannot be installed together. Some models may not be available in some regions.  
 \*2 With AR-PN1B, two or three holes can be punched depending on the paper size.  
 \*3 With AR-PN1C and AR-PN1D, the number of holes is the same. The hole interval, however, is not the same.

Specifications are subject to change for improvement without notice.

**NOTES**

- Transparency film, envelopes, postcards, and other special papers cannot be stapled.
- If mixed paper sizes are selected for stapling jobs, stapling will be automatically cancelled.

**Supplies**

AR-SC2 staple cartridges must be used for this finisher.  
 The cartridge package contains three cartridges of approximately 5000 staples each.

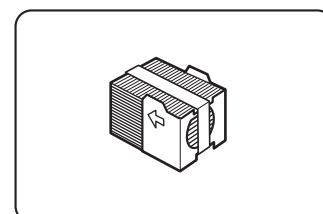

# Staple cartridge replacement and staple jam removal

When the staple cartridge becomes empty or staples become jammed, a message will appear in the message display of the operation panel.

Follow the procedure below to replace the staple cartridge or remove jammed staples.

## ■ Staple cartridge replacement

**1** Open the front cover.

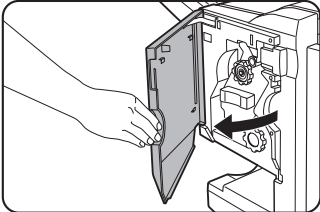

**2** Pull out the stapler section.

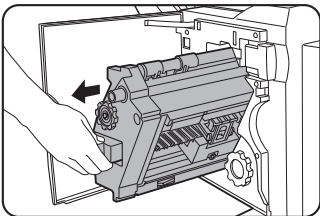

**3** Remove the empty staple box.

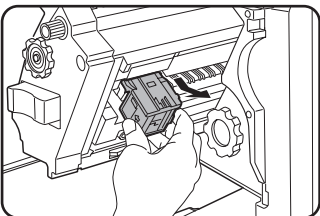

**4** Remove the empty staple cartridge.

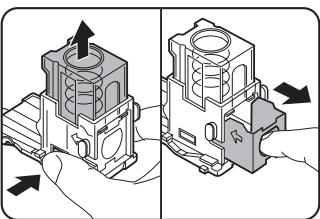

Press the lock button to unlock the staple box cover and remove the staple cartridge.

**NOTE**

If staples remain, the staple cartridge cannot be removed.

**5** Insert a new staple cartridge into the staple box.

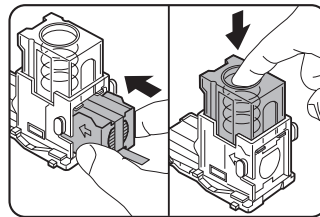

After inserting the staple cartridge, press down on the staple box cover to lock the cartridge in place.

**NOTES**

- Do not remove the tape from the cartridge before inserting the staple cartridge into the box.
- When reinstalling the staple box, push it in until it clicks into place.

**6** Remove the tape from the staple cartridge by pulling it straight back.

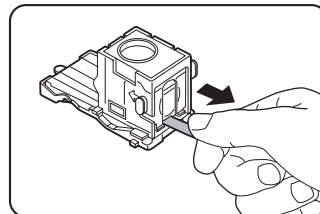

**7** Insert the staple box.

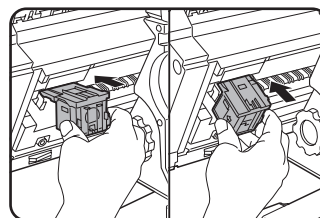

Push the staple box in until it clicks into place.

**8** Push the stapler section back into the finisher.

**9** Close the front cover.

**NOTE**

Make a test print in the staple sort mode to ensure that stapling is performed properly.

■ Staple jam removal

**1** Unlatch the saddle stitch finisher and slide it away from the main unit.

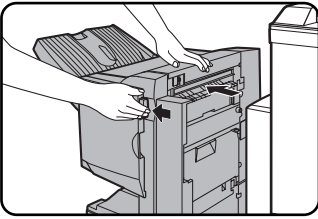

**2** Open the front cover.

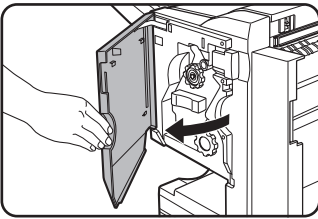

**3** Turn roller knob C as shown in the illustration until the blue indication is seen.

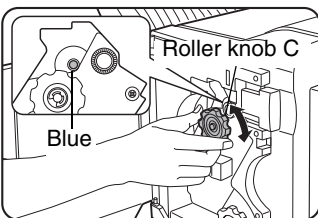

**4** Remove the paper from the stapler compiler.

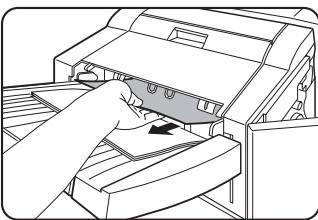

**5** If saddle stitching was selected, open the saddle stitch section cover.

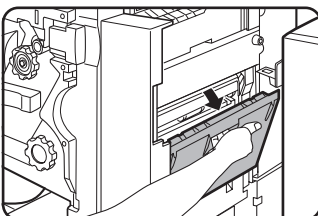

**6** Remove the misfed paper.

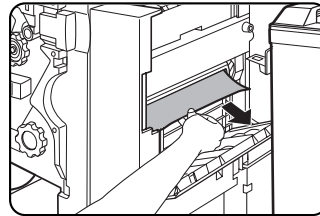

Be careful not to tear the misfed paper during removal.

**7** Close the saddle stitch section cover.

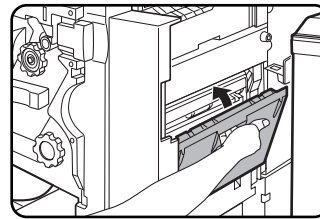

**8** Pull out the stapler section.

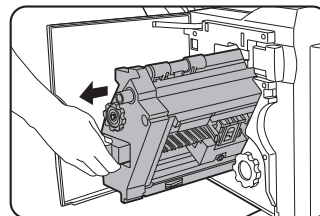

**9** Turn roller knob A in the direction of the arrow to move the staple unit to the front.

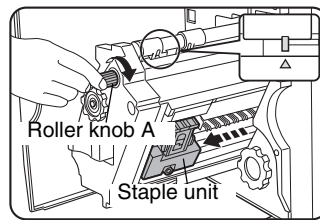

Turn the roller knob A until the triangle mark is aligned with the index.

**10** Remove the staple box.

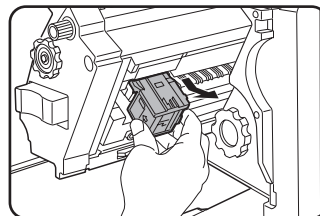

**11** Raise the lever at the end of the staple box.

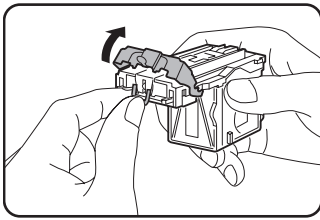

Remove the top staple if it is bent. If bent staples remain, a staple jam will occur again.

**12** Return the lever to its original position.

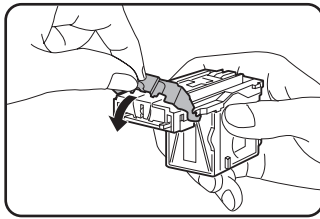

**13** Reinstall the staple box.

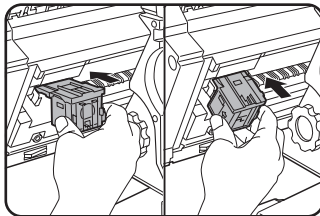

Push the staple box in until it clicks into place.

**14** Push the stapler section back into the finisher.

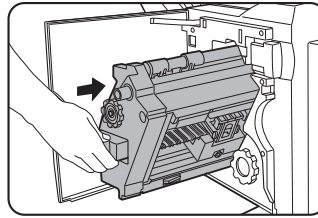

**15** Close the front cover.

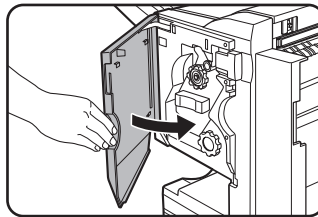

**16** Push the saddle stitch finisher back against the main unit.

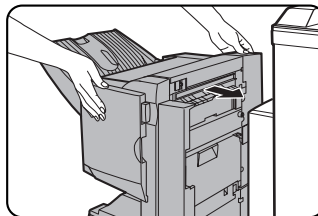

**NOTE**

Make a test print in the staple sort mode to ensure that stapling is performed properly.

**■ Disposal of hole punch scrap (when the punch unit is installed)**

**1** Unlatch the saddle stitch finisher and slide it away from the main unit.

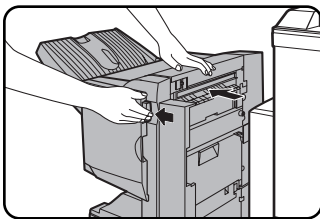

**2** Pull out the punch scrap container and empty it.

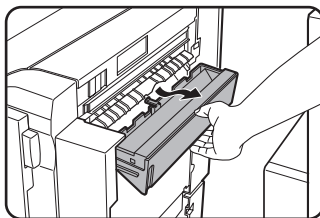

Discard the punch scraps in a plastic bag or other container, taking care not to let the scraps scatter.

**3** Return the punch scrap container to its original position.

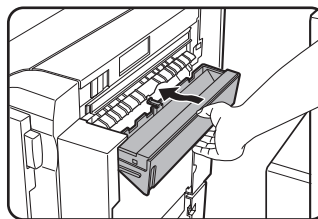

**4** Push the saddle stitch finisher back against the main unit.

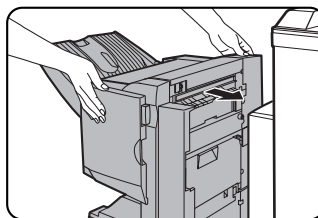



## Misfeed in the saddle stitch finisher

When a misfeed occurs in the saddle stitch finisher, remove the misfed paper as follows.

- 1** Unlatch the saddle stitch finisher and slide it away from the main unit.

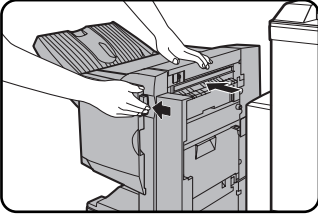

- 2** Remove the misfed paper from the main unit.

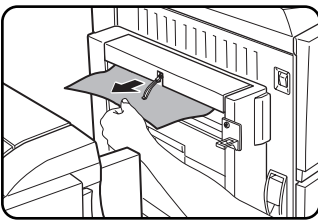

After removing the misfed paper, open and close the duplex bypass/inverter to reset the jam indicator. (See "Misfeed in the Fusing area" steps 1 and 4 on page 2-25.)

- 3** If misfed paper is not found in step 1, open the top cover.

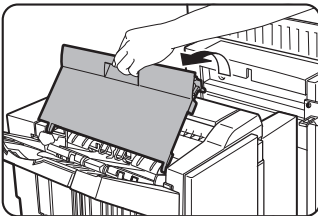

- 4** If the punch unit is installed, remove the misfed paper by pulling the paper while turning roller knob B.

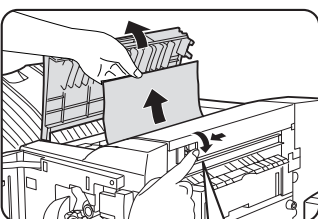

Take care not to tear the paper.

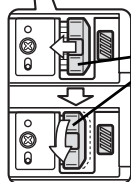

Roller knob B

- 5** Close the top cover.

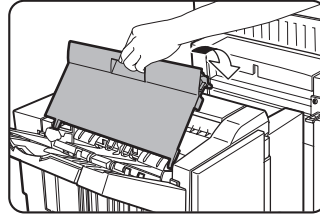

- 6** If saddle stitching was selected, open the front cover.

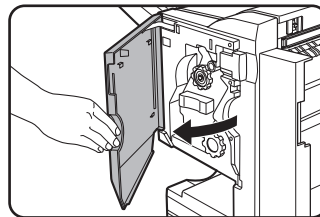

- 7** Turn roller knob C as shown in the illustration until the blue indicator is visible.

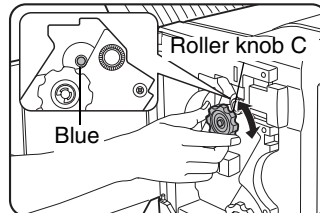

- 8** Remove the misfed paper from the stapler compiler.

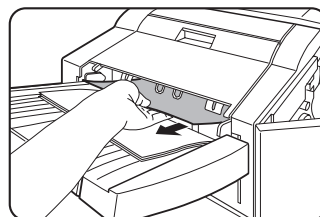

Be careful not to tear the misfed paper during removal.

- 9** Open the saddle stitch section cover.

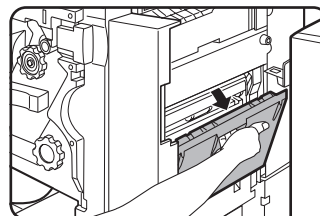

**10** Remove the misfed paper.

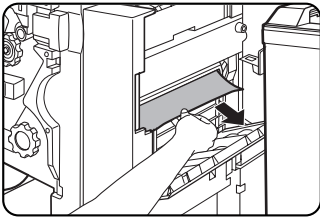

Be careful not to tear the misfed paper during removal.

**11** Turn the roller knob in the direction of the arrow.

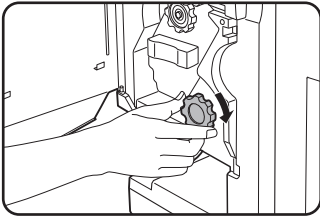

**12** Remove any misfed paper from the saddle stitch tray.

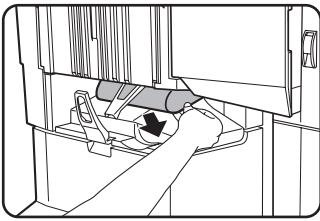

Be careful not to tear the misfed paper during removal.

**13** Close the saddle stitch section cover.

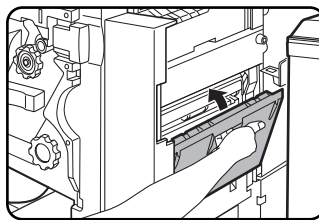

**14** Close the front cover.

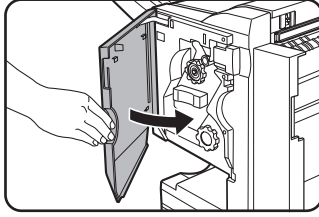

**15** Push the saddle stitch finisher back against the main unit.

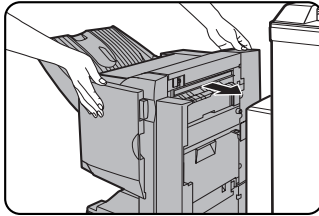

# LARGE CAPACITY TRAY

The large capacity tray provides the convenience of having 3,000 additional sheets of A4 (8-1/2" x 11") paper available.

## Part name

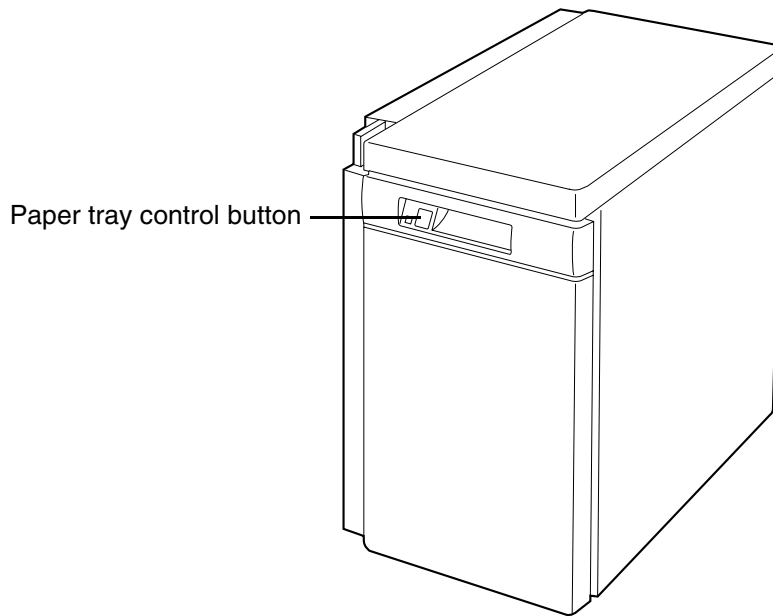

## Specifications

Paper size	A4 (8-1/2" x 11")
Page weight	64 to 105 g/m <sup>2</sup> (17 to 28 lbs.)
Paper capacity	3,000 sheets (80 g/m <sup>2</sup> (20 lbs.))
Weight	Approximately 32.5 kg (71.7 lbs.)
Dimensions	330 mm (W) x 541 mm (D) x 595 mm (H) (13" (W) x 21-5/16" (D) x 23-7/16" (H))

Specifications are subject to change for improvement without notice.

## Loading paper

The large capacity tray will automatically lower when the tray runs out of paper.

- 1 Press the paper tray control button on the large capacity tray.**

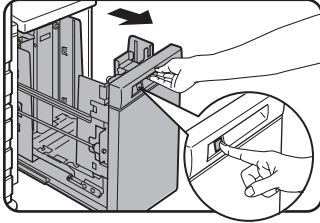

The button lamp will blink while the feed table is lowering and will go out when the tray is ready to be opened.

- 2 When the button lamp goes out, pull the paper tray out.**

Do not pull the paper tray out before the button lamp goes out.

- 3 Fan the paper.**

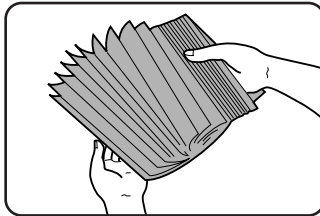

- 4 Load the paper onto the feed table.**

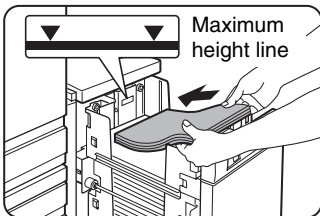

Be sure to load paper appropriate for the large capacity tray. Do not exceed the maximum height line.

- 5 Gently push the large capacity tray back into place.**

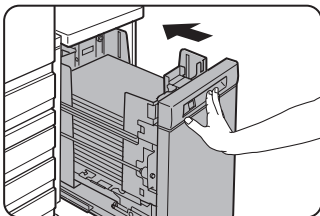

The paper tray control button lamp will blink as the feed table returns to the feed position and will light up steadily when it is in position to feed.

## Misfeed removal

When a misfeed occurs in the large capacity tray, follow these steps to remove the misfed paper.

- 1** While holding the tray release lever, carefully slide the large capacity tray away from the main unit until it stops.



- 2** Remove any misfed paper from the main unit and the large capacity tray.

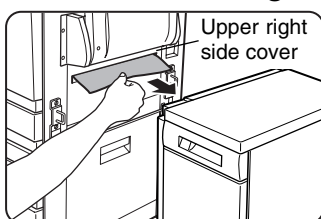

Be sure not to tear the misfed paper during removal.

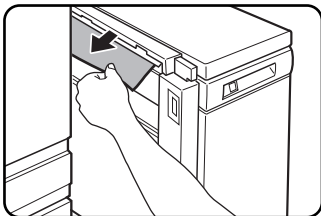

Open and close the upper right side cover of the printer after removing the misfed paper from the printer.

If the misfed paper cannot be removed easily, open the upper right side cover to remove the paper.

- 3** Push the large capacity tray toward the main unit and latch it into place.



- 4** If misfed paper is not found in step 2, pull the tray out.

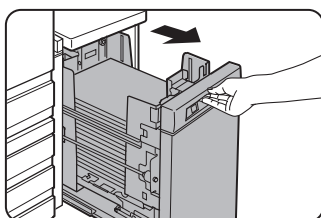

When pulling the large capacity tray out, be sure to pull it out after the paper tray control button lamp goes out.

- 5** Remove the misfed paper.

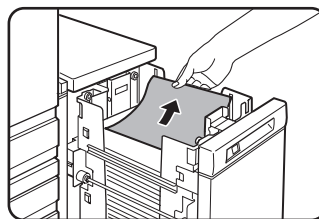

- 6** Gently push the tray back into place.

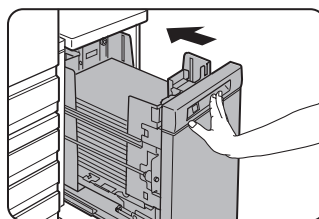

Confirm that the misfeed display is cleared.





# CHAPTER 6

---

## SPECIFICATIONS

---

This chapter provides specifications for the items indicated below. For the specifications of the peripheral devices, see Chapters 2 and 5. For the specifications of the stand with paper drawers, see page 2-7.

	Page
SPECIFICATIONS .....	6-2
• Printer .....	6-2
• Duplex bypass/inverter unit (optional).....	6-4
• Print area .....	6-4
INDEX .....	6-5

# SPECIFICATIONS

## Printer

Type	Desktop (can be upgraded to console type if an optional stand is installed.)
Print system	Electrophotographic system
Exposure system	LED head system
Developer system	Contact non-magnetic single-component development
Paper feed system	Paper trays
Fusing system	Press roller fusing method
CPU	Power PC 7410 - 500 MHz
Memory capacity (standard)	128 MB
DIMM slots for additional memory	Two (128 MB and/or 256 MB memory modules can be mounted.)
Page description language	PCL5c, PS3 emulation*
Resident font	Standard:Outline fonts European fonts: 80 fonts Line printer font: 1 font PostScript compatible font: 136* *An optional PS3 expansion kit is needed.
Interface	IEEE-1284 compatible parallel interface (P1284B connector)/USB 1.1/LAN
LAN connection	10Base-T/100Base-TX Supported protocols: IPX/SPX, TCP/IP, NetBEUI, Ether Talk For detailed network specifications, see the manual for the print server card. (The manual is provided in PDF format in the CD-ROM that accompanies the print server card.)
Operating system	IBM PC/AT or compatible computer: Windows® 95/98/Me, Windows NT® 4.0 (Service Pack3 or later), Windows® 2000, Windows® XP
Warm-up time	99 seconds or less
Resolution	600 x 600 dpi
Print colour	Black/Colour
Printing orientation	Portrait/landscape
Dimensions	670 mm (W) x 595 mm (D) x 480 mm (H) (26-25/64" (W) x 23-7/16" (D) x 18-29/32" (H))
Weight (main unit only)	Approx. 61 kg (134.5 lbs.)
Overall dimensions	994 mm (W) x 595 mm (D) (39-9/64" (W) x 23-7/16"(D))
Power supply	Local voltage $\pm 10\%$ (For power supply requirements, see the name plate on the right side of the rear of the machine.)
Power consumption	For power consumption requirement, see the name plate on the right side of the rear of the machine.
Operating environments*	Temperature: 15°C to 30°C (59°F to 86°F), Humidity: 20% to 80% * If the temperature is higher than 30°C (86°F), the humidity should be lower than 60%.



Continuous printing speed (when the offset function is not used)

	Black and white printing	Colour printing
Print paper size	100% / Reduced / Enlarged	100% / Reduced / Enlarged
A3 (11" x 17")	15 prints/min.	13 prints/min.
A3 wide (12" x 18")	7 prints/min.	7 prints/min.
B4 (8-1/2" x 14")	17 prints/min.	15 prints/min.
A4 (8-1/2" x 11")	A4 : 33 prints/min. 8-1/2" x 11" : 32 prints/min.	26 prints/min.
A4R (8-1/2" x 11"R)	22 prints/min.	19 prints/min.
B5R (7-1/4" x 10-1/2"R)	22 prints/min.	19 prints/min.
A5 (8-1/2" x 5-1/2")	33 prints/min.	26 prints/min.
Transparencies ([TRANSPARENCY S]*) (A4 (8-1/2" x 11"))	26 prints/min.	26 prints/min.
Transparencies ([TRANSPARENCY Q]) (A4 (8-1/2" x 11"))	13 prints/min.	13 prints/min.
Heavy paper 1/2 (A4 (8-1/2" x 11"))	13 prints/min.	13 prints/min.

\* The continuous printing speed when the fastest printing conditions are used.

Output tray specifications

Output method	Centre tray: Face-down output Left tray: Face-up output
Maximum number of sheets (A4 (8-1/2" x 11") size/recommended paper for colour)	Centre tray: 500 sheets Left tray: 250 sheets
Paper type	Centre tray: Plain paper (including recommended paper for colour) and heavy paper 1 (106 to 200 g/m <sup>2</sup> (28 to 54 lbs.)) Left tray: Plain paper and special paper
Paper size	Centre tray: A3W, A3, B4, A4, A4R, B5, B5R, A5 (12" x 18", 11" x 17", 8-1/2" x 14", 8-1/2" x 11", 8-1/2" x 11"R, 7-1/4" x 10-1/2"R, 8-1/2" x 5-1/2") Left tray: A3W, A3, B4, A4, A4R, B5, B5R, A5, A6R, Postcard (12" x 18", 11" x 17", 8-1/2" x 14", 8-1/2" x 11", 8-1/2" x 11"R, 7-1/4" x 10-1/2"R, 8-1/2" x 5-1/2")
Paper weight	Centre tray: 64 to 200 g/m <sup>2</sup> (17 to 54 lbs.) Left tray: 64 to 300 g/m <sup>2</sup> (17 to 80 lbs.)

6

Acoustic Noise Emission (measurement according to ISO07779)

		Printing mode		Standby mode
		Black/White*	Colour*	
Sound power level L <sub>WA</sub>		6.9 B	6.8 B	3.8 B
Sound pressure level L <sub>pA</sub> (reference)	Bystander positions	55 dB(A)	54 dB(A)	24 dB(A)
	Operator position	58 dB(A)	57 dB(A)	30 dB(A)

\* Noise emission when peripheral devices are installed

Emission Concentration (measurement according to RAL UZ62)

Ozone	0.02 mg/m <sup>3</sup> or less
Dust	0.075 mg/m <sup>3</sup> or less
Styrene	0.07 mg/m <sup>3</sup> or less

Some discrepancies may exist in the illustrations and content due to improvements to the machine.

## Duplex bypass/inverter unit (optional)

Number of sheets	1 sheet (non-stack method)
Paper size	Face-up output: Same as paper feed specifications of the machine Face-down output: A3W, A3, B4, A4, A4R, B5, B5R, A5, 12" x 18", 11" x 17", 8-1/2" x 14", 8-1/2" x 13", 8-1/2" x 11", 8-1/2" x 11"R, 7-1/4" x 10-1/2"R, 8-1/2" x 5-1/2",
Page weight	Face-up output: 64 to 300 g/m <sup>2</sup> (17 to 80 lbs.) Face-down output: 64 to 200 g/m <sup>2</sup> (17 to 54 lbs.)
Transport reference point	Centre reference point
Dimensions	156 mm (W) x 443 mm (D) x 432 mm (H) (6-5/32" (W) x 17-29/64" (D) x 17-1/64" (H))
Weight	Approx. 6.5 kg (Approx. 14.4 lbs.)

## Print area

The print area of this product is shown below.

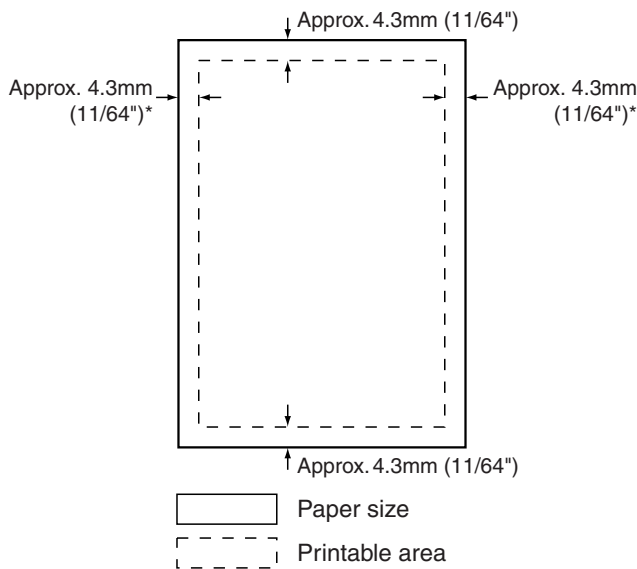

The print area is the entire page excluding a margin of 4.3 mm (11/64") at each edge. The actual print area may vary depending on the printer driver used and software application.

\* The print area of A3 wide paper is the entire page excluding a margin of approximately 3 mm (1/8") at each edge.

Some discrepancies may exist in the illustrations and content due to improvements to the machine.

# INDEX

## ■ A

Applicable paper sizes ..... 2-9 to 2-10  
Applicable paper types ..... 2-9 to 2-10  
Auto power shut-off mode ..... 1-3  
Automatic two-sided printing ..... 1-6, 2-8, 2-10

## ■ B

Black toner ..... 2-20  
Bypass tray ..... 0-3, 1-4, 1-9, 2-4, 2-14, 2-24

## ■ C

Call for service ..... 2-29  
Centre tray ..... 1-4, 1-7, 2-10, 6-3  
Changing the paper size ..... 2-3  
Clock adjust ..... 2-17, 2-19  
Colour deviations occur ..... 2-6, 2-30  
Contents ..... 0-5  
Custom settings ..... 1-9, 2-17  
Cyan toner ..... 2-20

## ■ D

Disposal of hole punch scrap ..... 5-6  
Does not operate ..... 2-29  
Duplex bypass/inverter unit ..... 1-6, 2-27, 6-4  
Duplex module/2 x 500 sheet paper drawer ..... 1-6, 2-8, 2-27

## ■ E

Energy saving features ..... 1-3  
Energy Star guidelines ..... 1-3  
Envelopes ..... 2-4, 2-9 to 2-10, 2-14 to 2-15  
Extra size ..... 2-3, 2-13, 2-30

## ■ F

Face-up and face-down output ..... 1-7  
Features ..... 1-3  
Folded postcards ..... 2-10  
Front cover ..... 1-4, 2-20, 2-23, 5-2  
Fusing unit ..... 0-4, 1-5, 2-23, 2-25  
Fusing unit pressure adjusting levers ..... 2-6 to 2-7

## ■ H

Heavy 1, Heavy 2 ..... 2-9 to 2-10, 2-14  
Heavy paper ..... 2-9 to 2-10, 6-3  
Hole punching (Punch unit) ..... 5-2, 5-3

## ■ I

If the machine is to be left unused for a long time.. 0-3  
Information ..... 1-8, 2-23  
Installation requirements ..... 0-2  
Interior ..... 1-5

## ■ J

Job status screen ..... 1-8, 1-9

## ■ K

Key operator program ..... 0-1, 1-9

## ■ L

Large capacity tray ..... 1-6, 5-9 to 5-11  
Left side cover ..... 1-4  
Left side cover release ..... 1-4  
Left tray ..... 1-4, 6-3  
Loading paper in the bypass tray ..... 2-4 to 2-6  
Loading paper  
- Bypass tray ..... 2-4  
- Duplex module/2 x 500 sheet paper drawer ..... 2-8  
- Large capacity tray ..... 5-10  
- Paper tray 1 ..... 2-2  
- Stand/1 x 500 sheet paper drawer ..... 2-7  
- Stand/3 x 500 sheet paper drawer ..... 2-7  
Loading postcards ..... 2-4 to 2-6

## ■ M

Magenta toner ..... 2-20  
Main features ..... 1-3  
Main switch ..... 1-4  
Meaning of "R" ..... 1-2  
Message display ..... 1-8  
Misfeed in the exit area ..... 2-25  
Misfeed in the fusing area ..... 2-25  
Misfeed in the paper feed area ..... 2-24  
Misfeed in the transport area ..... 2-25  
Misfeed removal ..... 2-23 to 2-28, 5-7 to 5-8, 5-11  
More information on plain paper ..... 2-10  
More information on special media ..... 2-10  
Moving this machine ..... 0-3

## ■ N

Non-standard size ..... 2-13, 2-15

## ■ O

Offset ..... 1-3, 5-2, 6-3  
Offset tray ..... 5-2  
Operation panel ..... 1-8  
Output ..... 1-7, 3-4, 5-2, 6-3  
Output tray ..... 2-5, 3-4  
Output tray specifications ..... 6-3

■ P

Paper curled ..... 2-30  
 Paper recommended for colour ..... 2-9  
 Paper size slide ..... 2-3  
 Paper tray 1 ..... 2-2, 2-9, 2-24  
 Paper tray ..... 1-4, 2-9  
 Part names and functions  
   - Exterior ..... 1-4  
   - Interior ..... 1-5  
   - Large capacity tray ..... 1-6, 5-9  
   - Operation panel ..... 1-8  
   - Saddle stitch finisher ..... 1-6, 5-2  
 Peripheral devices ..... 1-6, 5-1  
 Plain paper ..... 2-9 to 2-10  
 Portrait ..... 1-2  
 Postcards ..... 2-4 to 2-6  
 Preheat mode ..... 1-3  
 Print ..... 4-1  
 Print job ..... 1-10, 4-2  
 Print list ..... 2-17, 2-19  
 Print server card ..... 6-2

■ R

Replacing the toner cartridges ..... 2-20  
 Right cover of paper drawer ..... 1-5  
 Right side cover ..... 1-5

■ S

Saddle stitch finisher ..... 1-6, 5-2 to 5-8  
 Saddle stitch tray ..... 5-2  
 Setting the paper size  
   - Bypass tray ..... 2-15  
   - Extra size ..... 2-13  
 Setting the paper type ..... 2-12, 2-15  
 Size slide ..... 2-3, 2-13  
 Special papers ..... 2-9 to 2-10  
 Specifications ..... 6-2  
   - Duplex bypass/inverter unit ..... 6-4  
   - Duplex module/2 x 500 sheet paper drawer ..... 2-8  
   - Large capacity tray ..... 5-9  
   - Printer ..... 6-2  
   - Saddle stitch finisher ..... 5-2  
   - Stand/1 x 500 sheet paper drawer ..... 2-7  
   - Stand/3 x 500 sheet paper drawer ..... 2-7  
 Specifications of paper trays ..... 2-9  
 Stand/1 x 500 sheet paper drawer ..... 1-6, 2-7, 2-26  
 Stand/3 x 500 sheet paper drawer ..... 1-6, 2-7, 2-26  
 Stand/paper drawer ..... 0-3  
 Standard sizes ..... 1-2, 2-9 to 2-10  
 Standard sizes in both the inch and AB systems ... 1-2  
 Standard supplies ..... 2-22  
 Staple cartridge ..... 5-3  
 Staple cartridge replacement ..... 5-4  
 Staple jam removal ..... 5-4  
 Staple sort ..... 5-4, 5-6  
 Stapler compiler ..... 5-2  
 Stapler section ..... 5-2  
 Stapling positions ..... 5-3  
 Storage of supplies ..... 2-22

■ T

The machine does not operate ..... 2-29  
 Toner cartridge ..... 1-5, 2-20  
 Total count ..... 2-17, 2-19  
 Transfer belt ..... 2-23, 2-25  
 Transparency film ..... 2-5, 2-9 to 2-10  
 Transparency Q ..... 2-9, 2-14 to 2-15  
 Transparency S ..... 2-9, 2-14 to 2-15  
 Tray extension ..... 2-4  
 Tray setting ..... 2-11 to 2-12  
 Troubleshooting ..... 2-29 to 2-30

■ W

Warm-up time ..... 2-29, 6-2  
 Wire extension ..... 2-4

■ Y



Yellow toner ..... 2-20

Required in IEC-950 (EN 60 950) - Europe

- The equipment should be installed near an accessible socket outlet for easy disconnection.

Required in Appendix ZB of BS 7002 (En 60 950) — United Kingdom

### MAINS PLUG WIRING INSTRUCTIONS

The mains lead of this equipment is already fitted with a mains plug which is either a non-rewireable (moulded) or a rewireable type. Should the fuse need to be replaced, a BSI or ASTA approved fuse to BS1362 marked  or  and of the same rating as the one removed from the plug must be used.

Always refit the fuse cover after replacing the fuse on the moulded plug. Never use the plug without the fuse cover fitted.

In the unlikely event of the socket outlet in your home not being compatible with the plug supplied either cut-off the moulded plug (if this type is fitted) or remove by undoing the screws if a rewireable plug is fitted and fit an appropriate type observing the wiring code below.

**DANGER:** The fuse should be removed from the cut-off plug and the plug destroyed immediately and disposed of in a safe manner. Under no circumstances should the cut-off plug be inserted elsewhere into a 13A socket outlet as a serious electric shock may occur.

To fit an appropriate plug to the mains lead, follow the instructions below:

**IMPORTANT:** The wires in this mains lead are coloured in accordance with the following code:

<b>GREEN-AND-YELLOW:</b>	<b>Earth</b>
<b>BLUE:</b>	<b>Neutral</b>
<b>BROWN:</b>	<b>Live</b>

As the colours of the wires in this mains lead may not correspond with coloured markings identifying the terminals in your plug, proceed as follows:

The wire which is coloured **GREEN-AND YELLOW** must be connected to the terminal in the plug which is marked with the letter **E**, or by the safety earth symbol , or coloured green or green-and-yellow.

The wire which is coloured **BLUE** must be connected to the terminal which is marked with the letter **N** or coloured black.

The wire which is coloured **BROWN** must be connected to the terminal which is marked with the letter **L** or coloured red.

If you have any doubt, consult a qualified electrician.

**WARNING: THIS APPARATUS MUST BE EARTHED.**

## Warranty

While every effort has been made to make this document as accurate and helpful as possible, SHARP Corporation makes no warranty of any kind with regard to its content. All information included herein is subject to change without notice. SHARP is not responsible for any loss or damages, direct or indirect, arising from or related to the use of this operation manual.

© Copyright SHARP Corporation 2002. All rights reserved. Reproduction, adaptation or translation without prior written permission is prohibited, except as allowed under copyright laws.

## Trademark Acknowledgments

Microsoft Windows, MS-DOS, and Windows NT are trademarks of Microsoft Corporation in the U.S.A. and other countries.

IBM, PC/AT, and PowerPC are trademarks of International Business Machines Corporation.

Pentium is a registered trademark of Intel Corporation.

PCL is a trademark of the Hewlett-Packard Company.

NetWare is a registered trademark of Novell, Inc.

All other trademarks and copyrights are the property of their respective owners.

**SHARP®**