

# SHARP OPERATION GUIDE

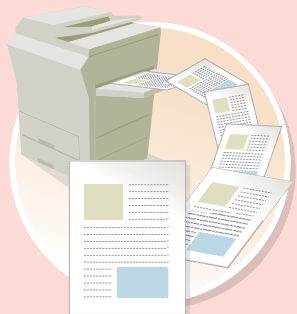

**Search based on  
what you want to do**



**MAKE A COPY**

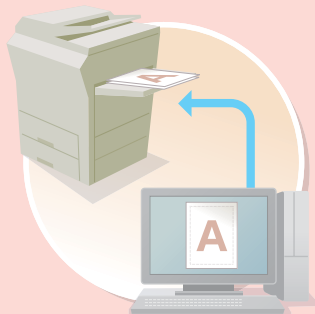

**PRINT A DOCUMENT**



**SEND A FAX**

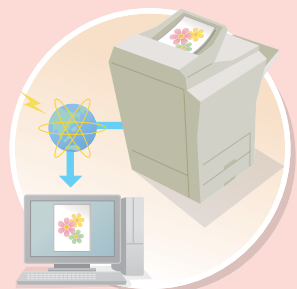

**SCAN AN IMAGE /  
SEND AN INTERNET FAX**

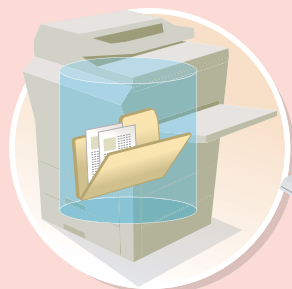

**SAVE A JOB AND  
REUSE IT LATER**

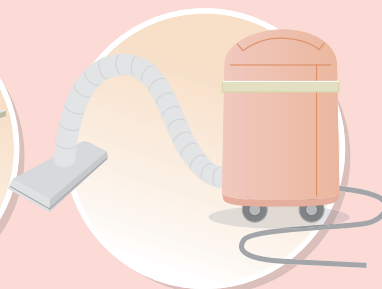

**MAINTAIN  
THE MACHINE**



**Search using the  
table of contents**



**BEFORE USING THE MACHINE**



**COPIER**



**PRINTER**



**FACSIMILE**



**SCANNER / INTERNET FAX**



**DOCUMENT FILING**



**SYSTEM SETTINGS**



**TROUBLESHOOTING**

# MAKE A COPY

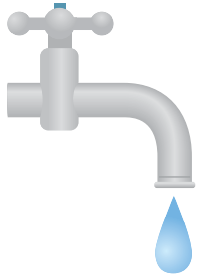

**Conserve**

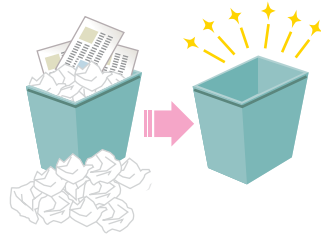

**Reduce copy mistakes**

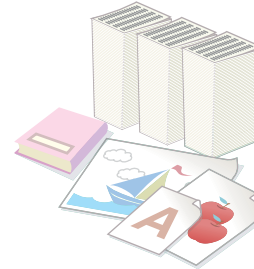

**Make a copy of this type of original**



**Make a copy on this type of paper**



**Add the date or page numbers**

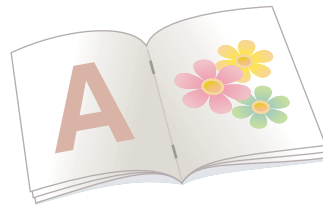

**Assemble output into a pamphlet**



**Other convenient functions**

# Conserve



**Copy on both sides of the paper**

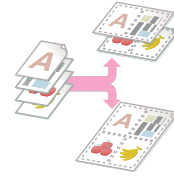

**Copy multiple pages on one side of one sheet of paper**

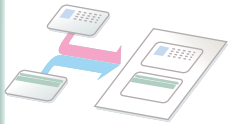

**Copy on the front and back of a card**

# Reduce copy mistakes



**Print one set of copies for proofing**



**Check the number of scanned pages before making copies**

# Make a copy of this type of original



**Mixed colour and black & white originals**



**More original pages than can be loaded at once**



**Mixed-size originals**

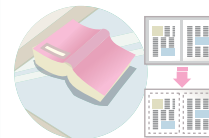

**Bulky original (shadows appear at edges)**

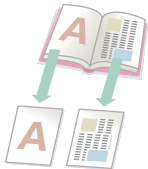

**Bound original such as a book (one page at a time)**

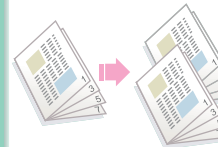

**Book or pamphlet (make facing page copies)**

# Make a copy on this type of paper



**Envelopes and other special media**

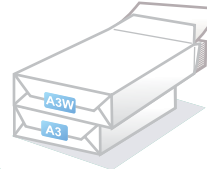

**A3 wide paper**



**Tab Paper**



**Transparency film**

# Add the date or page numbers



**Add the date**



**Add a stamp**



**Add the page number**



**Add text**

# Assemble output into a pamphlet

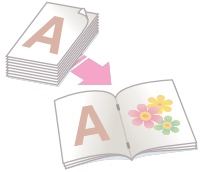

**Create a stapled pamphlet**

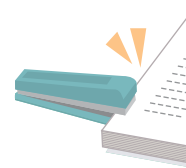

**Staple output**

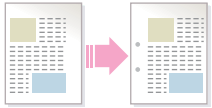

**Create a blank margin for punching**



**Punch holes in output**





# Other convenient functions

## Functions used for specific purposes

- Make a copy of arranged photos
- Create a large poster
- Make a mirror-image copy
- Copy onto the centre of the paper

## Convenient functions

- Use two machines simultaneously
- Give priority to a copy job
- Check the status of a reserved job
- Insert covers/inserts in copy output
- Copy a thin original
- Adjust the colour

# PRINT A DOCUMENT

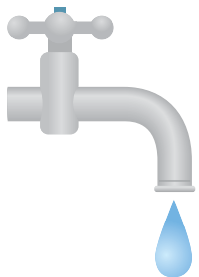

**Conserve**

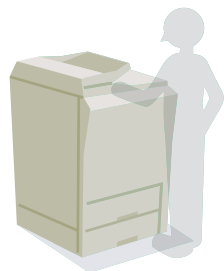

**Print without a  
computer**

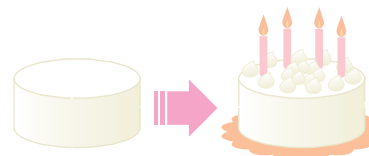

**Print attractive  
output**

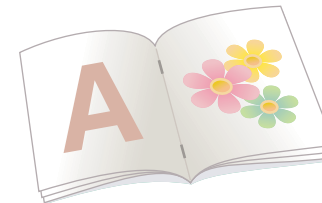

**Assemble output  
into a pamphlet**



**Print on this type  
of paper**

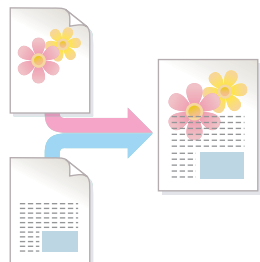

**Add text or an  
image**



**Other convenient functions**

# Conserve

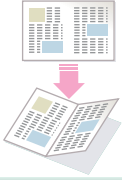

**Print on both sides of the paper**

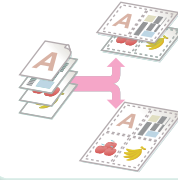

**Print multiple pages on one side of the paper**

# Print without a computer

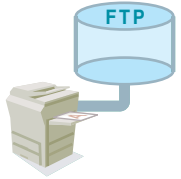

**Print a file on an FTP**

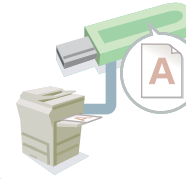

**Print a file in a USB  
memory device**



**Print a file in a network  
folder**

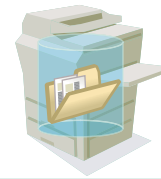

**Print a file stored in the  
machine**

# Print attractive output

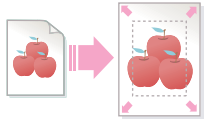

**Print matching the size of the paper**

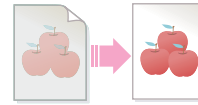

**Adjust the brightness and contrast**

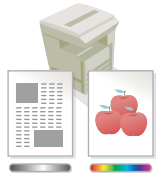

**Print using colour settings suitable for the data**

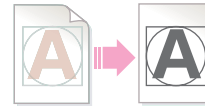

**Bring out faint text and lines**



**Select the print mode**

# Assemble output into a pamphlet

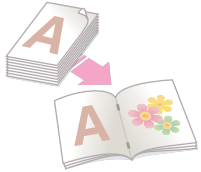

**Create a stapled pamphlet**

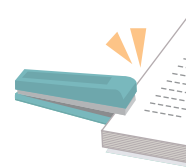

**Staple output**

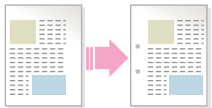

**Create a blank margin for punching**



**Punch holes in output**



**Print specific pages on the front side of the paper**

# Print on this type of paper

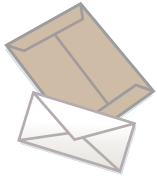

**Envelopes**



**Tab Paper**



**Transparency film**



**Print specific pages on  
different paper**

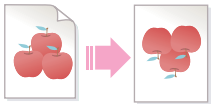

**Rotate the image 180  
degrees**

# Add text or an image

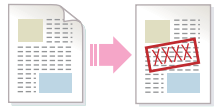

**Add a watermark to print data**

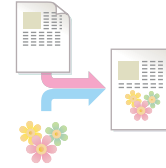

**Overlay an image on the print data**

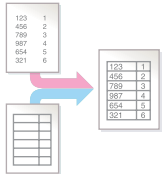

**Overlay a fixed form on the print data**





# Other convenient functions

## Correct the size or orientation of the print data

- Enlarge or reduce the print image
- Print a mirror-image

## Security is important

- Print confidentially
- Print an encrypted PDF file

## Functions used for specific purposes

- Print an "invoice copy"
- Create a large poster

## Convenient functions

- Give priority to a print job
- Use two machines simultaneously
- Store frequently used print settings
- Store a print job

# SEND A FAX

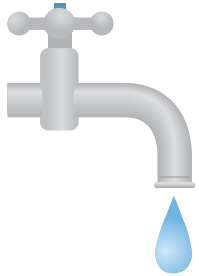

**Conserve**



**Send this type of document**

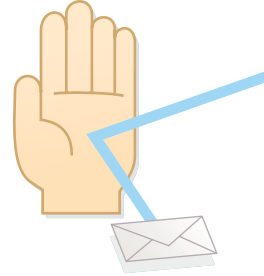

**Prevent transmission to the wrong destination**

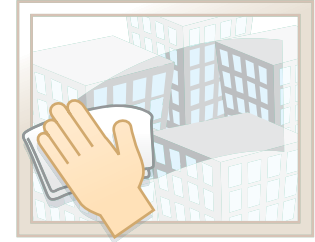

**Send a clear document**



**Save trouble**



**Security is important**



**Other convenient functions**

# Conserve



**Send when the rate is lowest**



**Check received data before printing**

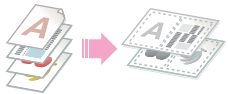

**Send two original pages as a single page**



**Relay a transmission through a branch office**

# Send this type of document

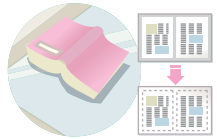

**Bulky original (shadows appear at edges)**

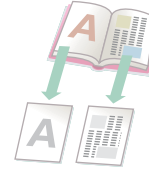

**Bound original such as a book (one page at a time)**



**More original pages than can be loaded at once**



**Mixed-size originals**



**Original printed on both sides**



**ID card or other card**

# Prevent transmission to the wrong destination



**Check the destination once more before sending**



**Check the result of transmission**



**Check the log of previous transmissions**



**Stamp scanned original pages**

# Send a clear document

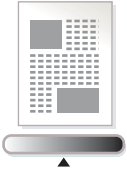

**Adjust the exposure**

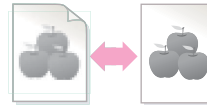

**Adjust the image quality**

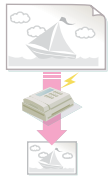

**Specify the size before sending**

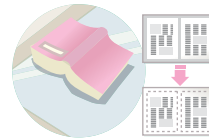

**Send without shadows at the edges**

# Save trouble

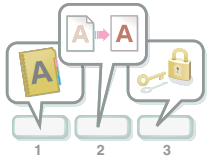

**Store frequently used settings**

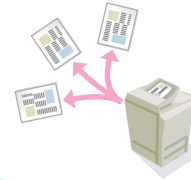

**Send to multiple destinations**

☎ XXXX-6789
☎ XXXX-9874
☎ XXXX-4567
☎ XXXX-5432
☎ XXXX-9999

**View the transmission log**

☎ XXXX-6789
☎ XXXX-9874
☎ XXXX-4567
☎ XXXX-5432
☎ XXXX-9999

**Easily specify an address (search number)**

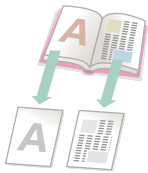

**Bound original such as a book (one page at a time)**

# Security is important



**Check the destination once more before sending**



**Send confidentially**



**Print protected reception data**

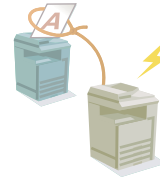

**Initiate reception of a document from a sending machine**

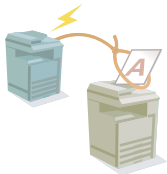

**Send a document at the other machine's request**





# Other convenient functions

## Convenient management functions

- Forward a received fax to a network address
- Print a list of addresses

## Convenient functions

- Send a thin original
- Select a transmission destination from a global address book
- Give priority to a transmission
- Use an extension phone

# SCAN AN IMAGE / SEND AN INTERNET FAX

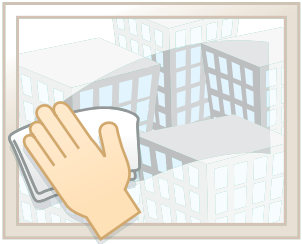

**Send a clear image**



**Send this type of document**

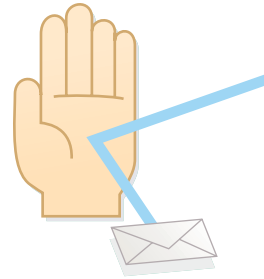

**Prevent transmission to the wrong destination**

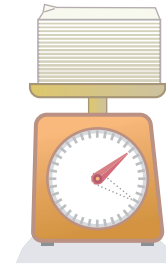

**Send a smaller file**



**Save trouble**

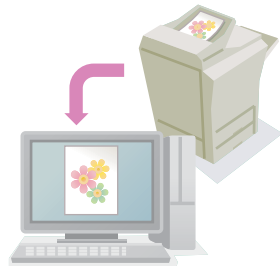

**Scan from my computer**



**Other convenient functions**

# Send a clear image

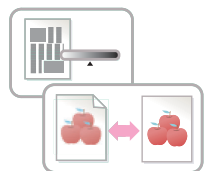

**Adjust the contrast or image quality**



**Adjust the resolution before sending**

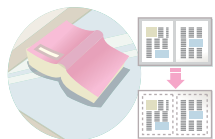

**Send without shadows at the edges**

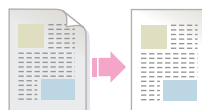

**Suppress the background of a transmitted document**

# Send this type of document

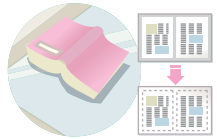

**Bulky original (shadows appear at edges)**

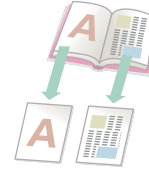

**Bound original such as a book (one page at a time)**



**More original pages than can be loaded at once**



**Mixed-size originals**



**Original printed on both sides**

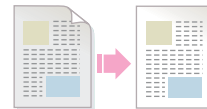

**Original with background**

# Prevent transmission to the wrong destination



**Check the result of transmission**



**Check the log of previous transmissions**



**Stamp scanned original pages**

# Send a smaller file

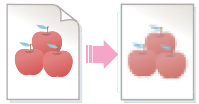

**Send at low resolution**

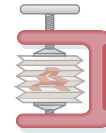

**Compress a file before sending**

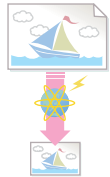

**Reduce an image before sending**

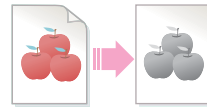

**Send an image in black & white**

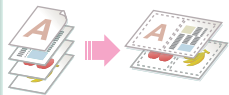

**Send two original pages as a single page**



**ID or other card**

# Save trouble

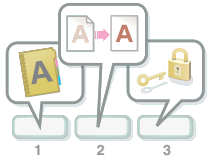

**Store frequently used settings**

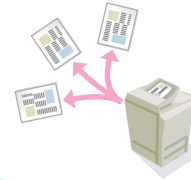

**Send to multiple destinations**



**View the transmission log**



**Easily specify an address (search number)**



**Send an Internet fax from a computer**

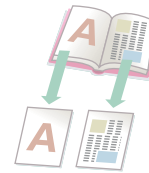

**Bound original such as a book (one page at a time)**



## Other convenient functions

### Convenient management functions

- Forward a received fax to a network address
- Print a list of transmission destinations

### Convenient functions

- Scan a thin original
- Select a transmission destination from a global address book
- Send at a specified time
- Give priority to a transmission
- Send in USB memory mode



# SAVE A JOB AND REUSE IT LATER



**Search for a file**

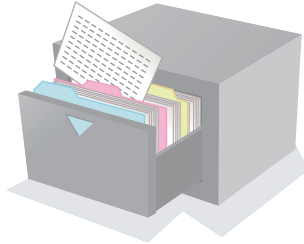

**Organize my files**

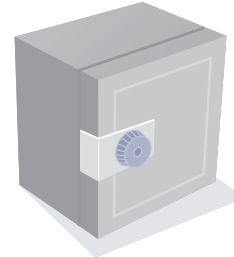

**Save an important document**

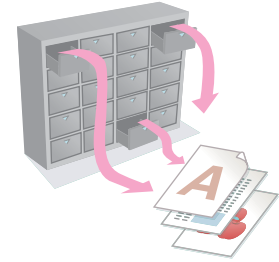

**Print a batch of files**

# Search for a file

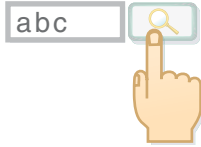

**Search for a file using a keyword**



**Search by checking the contents of files**

# Organize my files



**Delete a file**



**Delete all files**



**Periodically delete files**

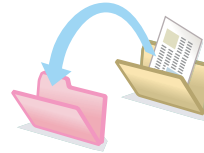

**Change the folder**

# MAINTAIN THE MACHINE



**Clean the machine**

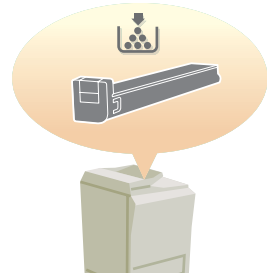

**Replace a toner cartridge**

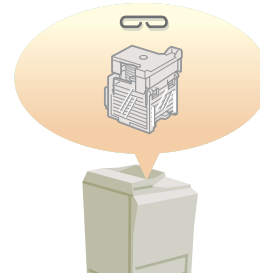

**Replace the staple cartridge**

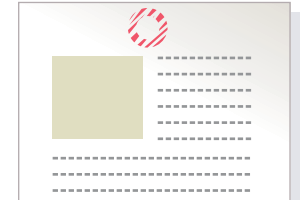

**Replace the stamp cartridge**

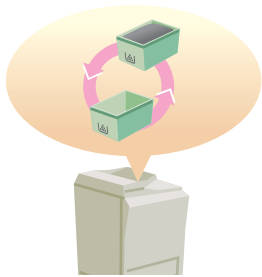

**Replace the waste toner box**

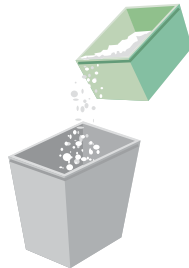

**Dispose of punch waste**

# Clean the machine



**Clean the document glass and  
automatic document feeder**

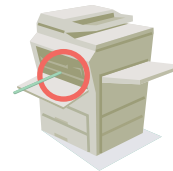

**Clean the main charger of  
the photoconductive drum**



**Clean the original feed  
roller**

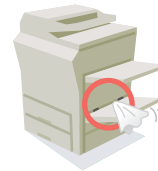

**Clean the bypass feed  
roller**

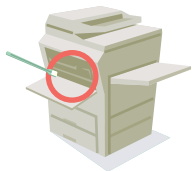

**Clean the laser unit**

# ABOUT OPERATION GUIDE

There are two ways to search for a topic in this guide: you can use an "I want to..." menu, or you can use a regular table of contents.

The following explanation assumes that Adobe Reader 8.0 is being used (Some buttons do not appear in the default state.).

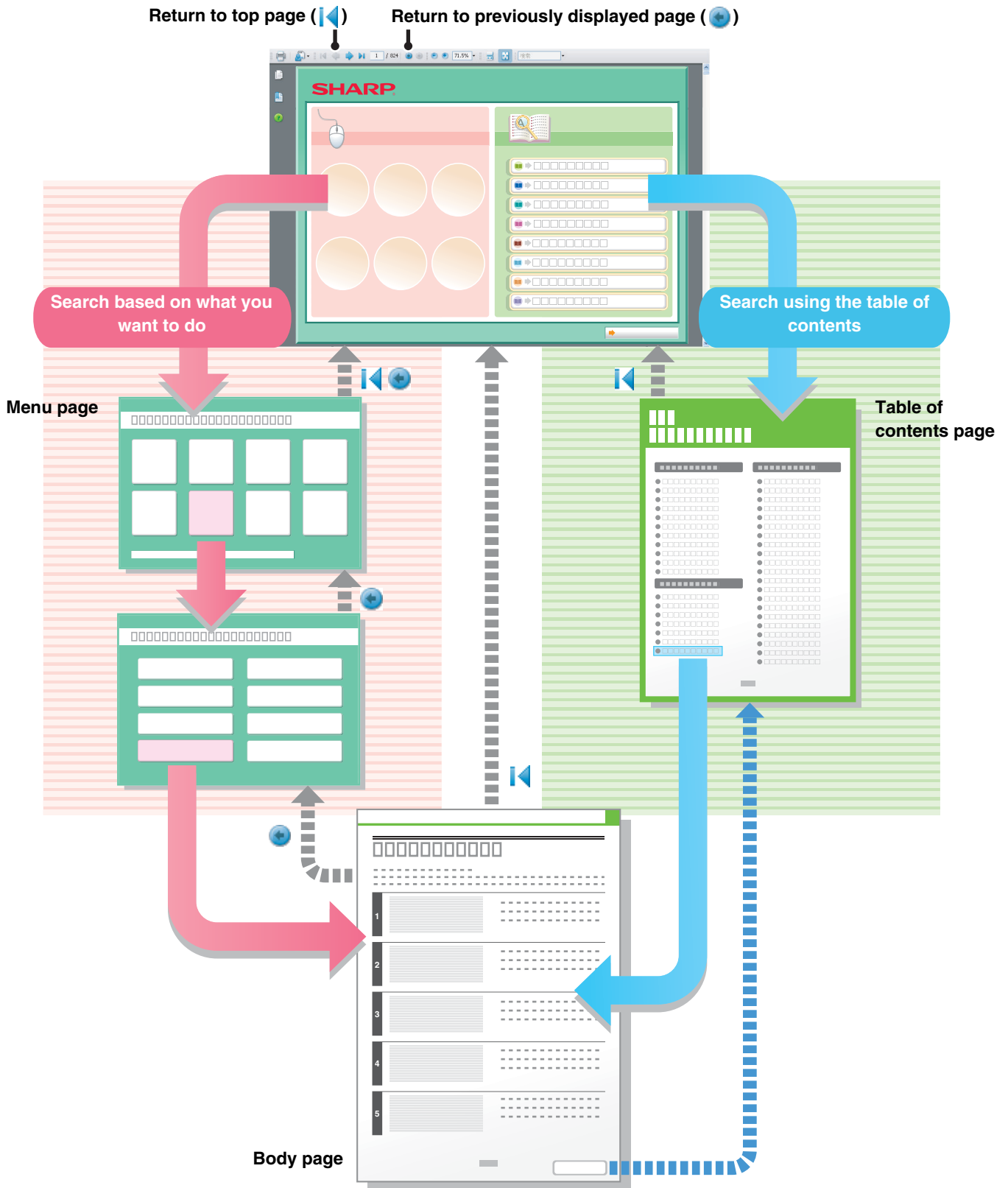

# HOW TO USE THIS MANUAL

Click a button below to move to the page that you wish to view.

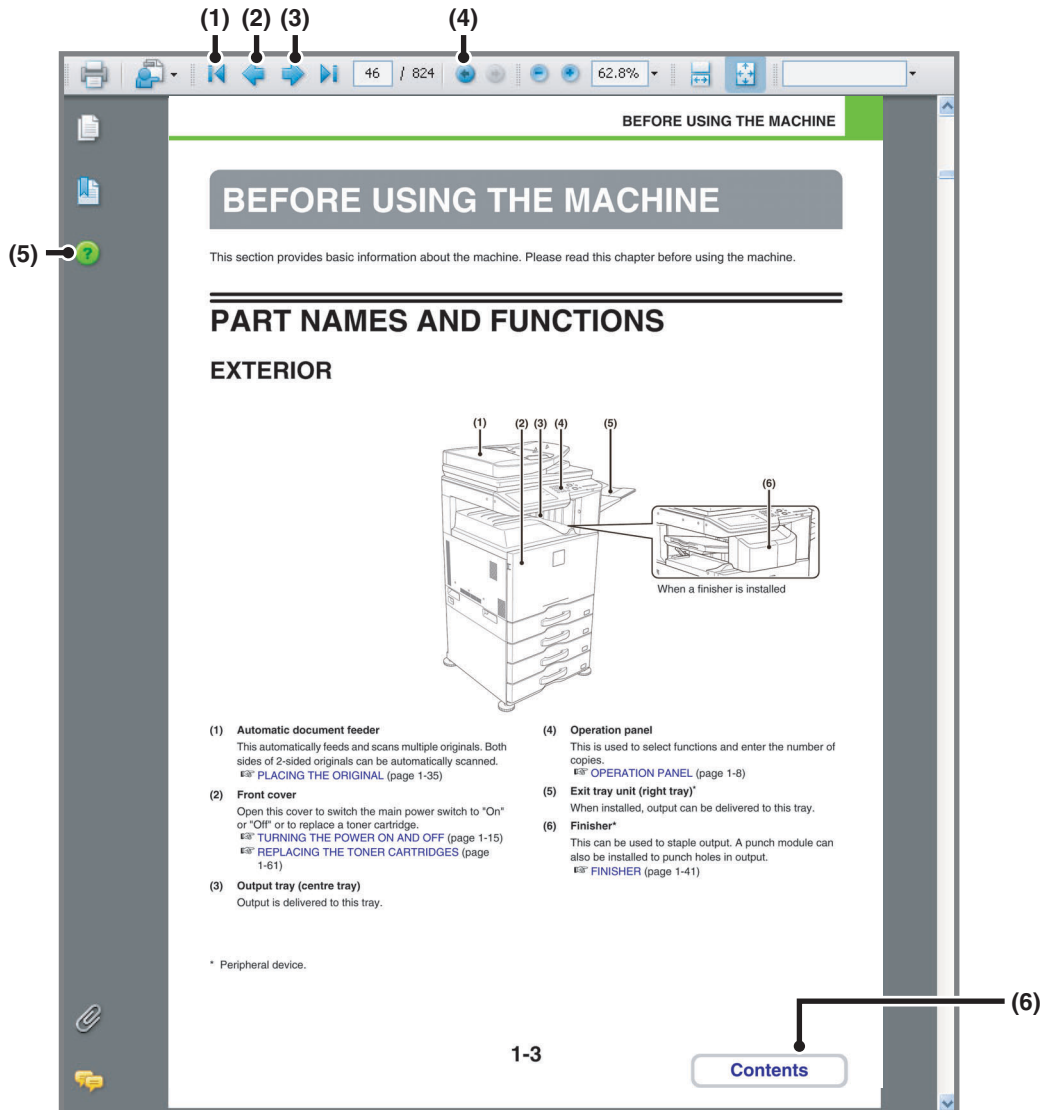

**(1) Return to top page button**

If an operation does not proceed as expected, click this button to start over again.

**(2) Back one page button**

Displays the previous page.

**(3) Forward one page button**

Displays the next page.

**(4) Return to previously displayed page button**

Displays the page that was displayed before the current page.

**(5) Adobe Reader Help button**

Opens Adobe Reader Help.

**(6) Contents button**

Displays the contents of each chapter.

For example, if the current page is a page in the body of the printer chapter, this button shows the contents of the printer chapter.



• If a button does not appear, refer to Adobe Reader Help to display the button.

**• Caution when printing**

If all pages are printed, the menu pages of the "I want to..." menu will also be printed. To print only the pages that contain the explanation of a function, specify a page range.

# MANUALS PROVIDED WITH THE MACHINE

## Operation manuals in PDF format (this manual)

The manuals in PDF format provide detailed explanations of the procedures for using the machine in each mode. To view the PDF manuals, download them from the hard drive in the machine. The procedure for downloading the manuals is explained in "How to read the Operation Guide" in the Start Guide. Alternatively, refer to the accessory CD-ROM.



### 1. BEFORE USING THE MACHINE

This chapter provides information, such as basic operation procedures, how to load paper, and machine maintenance.



### 2. COPIER

This chapter provides detailed explanations of the procedures for using the copy function.



### 3. PRINTER

This chapter provides detailed explanations of the procedures for using the print function.



### 4. FACSIMILE

This chapter provides detailed explanations of the procedures for using the fax function.



### 5. SCANNER / INTERNET FAX

This chapter provides detailed explanations of the procedures for using the scanner function and the Internet fax function.



### 6. DOCUMENT FILING

This chapter provides detailed explanations of the procedures for using the document filing function. The document filing function allows you to save the document data of a copy or fax job, or the data of a print job, as a file on the machine's hard drive. The file can be called up as needed.



### 7. SYSTEM SETTINGS

This chapter explains the "System Settings", which are used to configure a variety of parameters to suit the aims and the needs of your workplace. Current settings can be displayed or printed out from the "System Settings".



### 8. TROUBLESHOOTING

This chapter explains how to remove paper misfeeds and provides answers to frequently asked questions regarding the operation of the machine in each mode. Refer to this manual when you have difficulty using the machine.

## Printed manual

Manual name	Contents
Start Guide	This manual contains instructions for using the machine safely, describes preparations that must be made before using the machine, and lists the specifications of the machine and its peripheral devices.



# ABOUT OPERATION MANUAL

This manual explains how to use the MX-2314N/2614N/3114N digital full colour multifunctional system.

## Please note

- For information on installing the drivers and software cited in this manual, please refer to the Software Setup Guide.
- For information on your operating system, please refer to your operating system manual or the online Help function.
- The explanations of screens and procedures in a Windows environment are primarily for Windows 7. The screens may vary depending on the version of the operating system or the software application.
- The explanations of screens and procedures in a Macintosh environment are based on Mac OS X v10.4 in the case of Mac OS X. The screens may vary depending on the version of the operating system or the software application.
- Wherever "MX-xxxx" appears in this manual, please substitute your model name for "xxxx".
- This manual contains references to the fax function. However, please note that the fax function is not available in some countries and regions.
- Considerable care has been taken in preparing this manual. If you have any comments or concerns about the manual, please contact your dealer or nearest authorised service representative.
- This product has undergone strict quality control and inspection procedures. In the unlikely event that a defect or other problem is discovered, please contact your dealer or nearest authorised service representative.
- Aside from instances provided for by law, SHARP is not responsible for failures occurring during the use of the product or its options, or failures due to incorrect operation of the product and its options, or other failures, or for any damage that occurs due to use of the product.

## Warning

- Reproduction, adaptation or translation of the contents of the manual without prior written permission is prohibited, except as allowed under copyright laws.
- All information in this manual is subject to change without notice.



## Illustrations and the operation panel and touch panel shown in this manual





The peripheral devices are generally optional, however, some models include certain peripheral devices as standard equipment. The explanations in this manual assume that a right tray and paper drawer are installed on the MX-2614N. For some functions and procedures, the explanations assume that devices other than the above are installed.

The display screens, messages, and key names shown in the manual may differ from those on the actual machine due to product improvements and modifications.

## Icons used in the manuals

The icons in the manuals indicate the following types of information:

 <b>Warning</b>	This alerts you to a situation where there is a risk of human death or injury.
 <b>Caution</b>	This alerts you to a situation where there is a risk of human injury or property damage.

	This alerts you to a situation where there is a risk of machine damage or failure.		This indicates the name of a system setting and provides a brief explanation of the setting. <b>When "System Settings:" appears:</b> A general setting is explained. <b>When "System Settings (Administrator):" appears:</b> A setting that can only be configured by an administrator is explained.
	This provides a supplemental explanation of a function or procedure.		
	This explains how to cancel or correct an operation.		

# CHAPTER 1

# BEFORE USING THE MACHINE

This chapter provides information, such as basic operation procedures, how to load paper, and machine maintenance.

## BEFORE USING THE MACHINE

<b>PART NAMES AND FUNCTIONS</b> .....	<b>1-3</b>
• EXTERIOR .....	1-3
• INTERIOR .....	1-5
• AUTOMATIC DOCUMENT FEEDER AND DOCUMENT GLASS .....	1-6
• SIDE AND BACK .....	1-7
• OPERATION PANEL .....	1-8
<b>TOUCH PANEL</b> .....	<b>1-10</b>
• STATUS DISPLAY .....	1-12
• SYSTEM BAR .....	1-13
<b>TURNING THE POWER ON AND OFF</b> .....	<b>1-15</b>
• ENERGY SAVE FUNCTIONS .....	1-16
• [POWER SAVE] KEY .....	1-16
<b>USER AUTHENTICATION</b> .....	<b>1-17</b>
• AUTHENTICATION BY USER NUMBER .....	1-17
• AUTHENTICATION BY LOGIN NAME / PASSWORD .....	1-19
<b>HOME SCREEN</b> .....	<b>1-22</b>
<b>REMOTE OPERATION OF THE MACHINE</b> .....	<b>1-23</b>
<b>ITEMS RECORDED IN THE JOB LOG</b> .....	<b>1-24</b>

## LOADING PAPER

<b>IMPORTANT POINTS ABOUT PAPER</b> .....	<b>1-27</b>
• NAMES AND LOCATIONS OF TRAYS .....	1-27
• THE MEANING OF "R" IN PAPER SIZES .....	1-27
• USEABLE PAPER .....	1-28
<b>TRAY SETTINGS FOR TRAY 1 TO 4</b> .....	<b>1-30</b>
• LOADING PAPER AND CHANGING THE PAPER SIZE .....	1-30
<b>TRAY SETTINGS FOR TRAY 3 TO 4 (Stand/500&amp;2000 Sheet Paper Drawer)</b> .....	<b>1-32</b>
• LOADING PAPER IN PAPER TRAY 3 - TRAY 4 .....	1-32
• CHANGING THE PAPER SIZE IN PAPER TRAY 3 - TRAY 4 .....	1-33
<b>LOADING PAPER IN THE BYPASS TRAY</b> .....	<b>1-35</b>
• IMPORTANT POINTS WHEN USING THE BYPASS TRAY .....	1-36

## ORIGINALS

<b>PLACING THE ORIGINAL</b> .....	<b>1-38</b>
• PLACING ORIGINALS IN THE AUTOMATIC DOCUMENT FEEDER .....	1-38
• PLACING THE ORIGINAL ON THE DOCUMENT GLASS .....	1-40

## PERIPHERAL DEVICES

<b>PERIPHERAL DEVICES</b> .....	<b>1-42</b>
<b>FINISHER</b> .....	<b>1-44</b>
• PART NAMES .....	1-44
• SUPPLIES .....	1-44
• FINISHER MAINTENANCE .....	1-45
<b>PUNCH MODULE</b> .....	<b>1-47</b>
• DISCARDING PUNCH WASTE .....	1-47
<b>SHARP OSA</b> .....	<b>1-49</b>
• APPLICATION COMMUNICATION MODULE (MX-AMX2) .....	1-49
• EXTERNAL ACCOUNT MODULE (MX-AMX3) .....	1-50



**MAINTENANCE**

<b>REGULAR MAINTENANCE</b> .....	<b>1-52</b>
• CLEANING THE DOCUMENT GLASS AND AUTOMATIC DOCUMENT FEEDER ...	1-52
• CLEANING THE MAIN CHARGER OF THE PHOTOCONDUCTIVE DRUM.....	1-54
• CLEANING THE PT CHARGER OF THE PRIMARY TRANSFER BELT.....	1-57
• CLEANING THE BYPASS FEED ROLLER ...	1-59
• CLEANING THE ORIGINAL FEED ROLLER.....	1-59
• CLEANING THE LASER UNIT.....	1-60
<b>REPLACING THE TONER CARTRIDGES</b> .....	<b>1-64</b>
<b>REPLACING THE WASTE TONER BOX</b> .....	<b>1-67</b>
<b>REPLACING THE STAMP CARTRIDGE</b> .....	<b>1-69</b>

**ENTERING TEXT**

<b>FUNCTIONS OF THE MAIN KEYS</b> .....	<b>1-70</b>
• KEYBOARD .....	1-71

# BEFORE USING THE MACHINE

This section provides basic information about the machine. Please read this chapter before using the machine.

## PART NAMES AND FUNCTIONS

### EXTERIOR

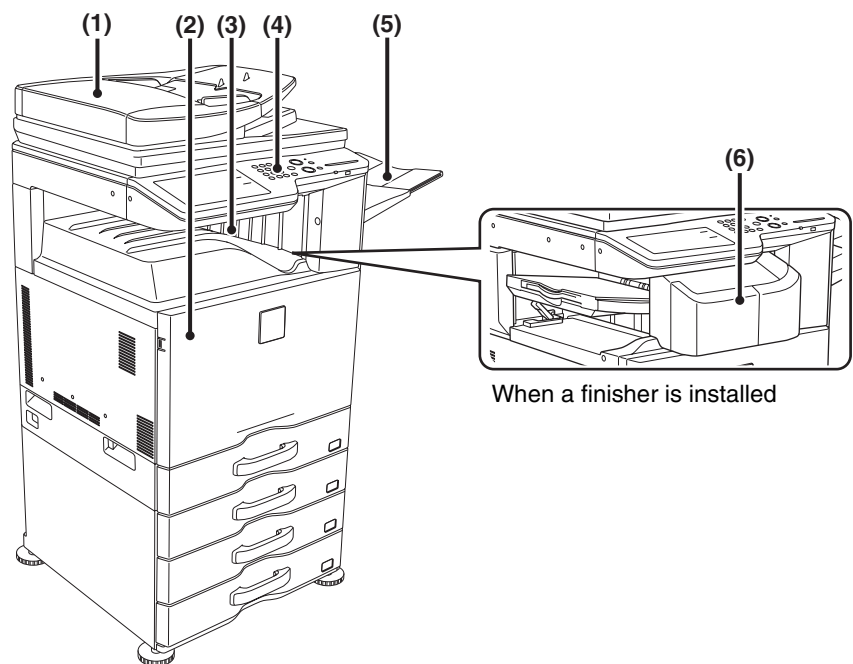

- |   |   |
|---|---|
| <p><b>(1) Automatic document feeder</b><br/>This automatically feeds and scans multiple originals. Both sides of 2-sided originals can be automatically scanned.<br/>➤ <a href="#">PLACING THE ORIGINAL</a> (page 1-38)</p> <p><b>(2) Front cover</b><br/>Open this cover to switch the main power switch to "On" or "Off" or to replace a toner cartridge.<br/>➤ <a href="#">TURNING THE POWER ON AND OFF</a> (page 1-15)<br/>➤ <a href="#">REPLACING THE TONER CARTRIDGES</a> (page 1-64)</p> <p><b>(3) Output tray (centre tray)</b><br/>Output is delivered to this tray.</p> | <p><b>(4) Operation panel</b><br/>This is used to select functions and enter the number of copies.<br/>➤ <a href="#">OPERATION PANEL</a> (page 1-8)</p> <p><b>(5) Exit tray unit (right tray)*</b><br/>When installed, output can be delivered to this tray.</p> <p><b>(6) Finisher*</b><br/>This can be used to staple output. A punch module can also be installed to punch holes in output.<br/>➤ <a href="#">FINISHER</a> (page 1-44)</p> |
|---|---|

\* Peripheral device.

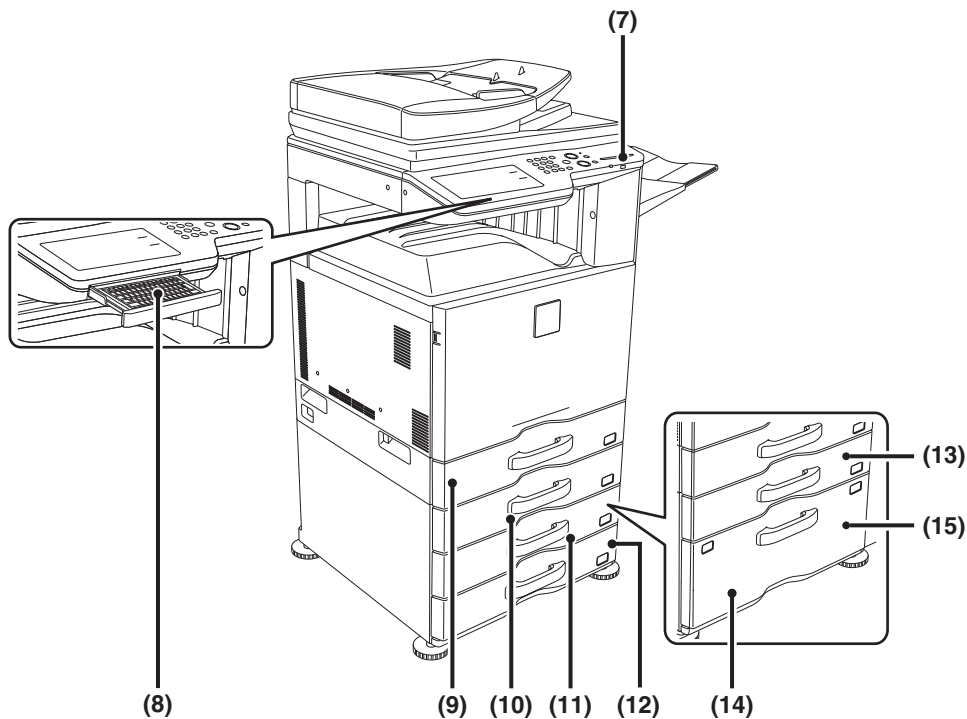
**(7) USB connector (A type)**

Supports USB 2.0 (Hi-Speed).  
This is used to connect a USB device such as USB memory to the machine.  
For the USB cable, use a shielded cable.

**(8) Keyboard\***

Use this as a substitute for the soft keyboard displayed on the touch panel. When not being used, it can be stored under the operation panel.  
➤ [KEYBOARD](#) (page 1-71)

**(9) Tray 1**

This holds paper.  
➤ [TRAY SETTINGS FOR TRAY 1 TO 4](#) (page 1-30)

**(10) Tray 2 (when a paper drawer is installed)\***

This holds paper.  
➤ [TRAY SETTINGS FOR TRAY 1 TO 4](#) (page 1-30)

**(11) Tray 3 (when a paper drawer is installed)\***

This holds paper.  
➤ [TRAY SETTINGS FOR TRAY 1 TO 4](#) (page 1-30)

**(12) Tray 4 (when a paper drawer is installed)\***

This holds paper.  
➤ [TRAY SETTINGS FOR TRAY 1 TO 4](#) (page 1-30)

**(13) Tray 2 (when a stand/500&2000 sheet paper drawer is installed)\***

This holds paper.  
➤ [TRAY SETTINGS FOR TRAY 1 TO 4](#) (page 1-30)

**(14) Tray 3 (when a stand/500&2000 sheet paper drawer is installed)\***

This holds paper.  
➤ [TRAY SETTINGS FOR TRAY 3 TO 4 \(Stand/500&2000 Sheet Paper Drawer\)](#) (page 1-32)

**(15) Tray 4 (when a stand/500&2000 sheet paper drawer is installed)\***

This holds paper.  
➤ [TRAY SETTINGS FOR TRAY 3 TO 4 \(Stand/500&2000 Sheet Paper Drawer\)](#) (page 1-32)

\* Peripheral device.

# INTERIOR

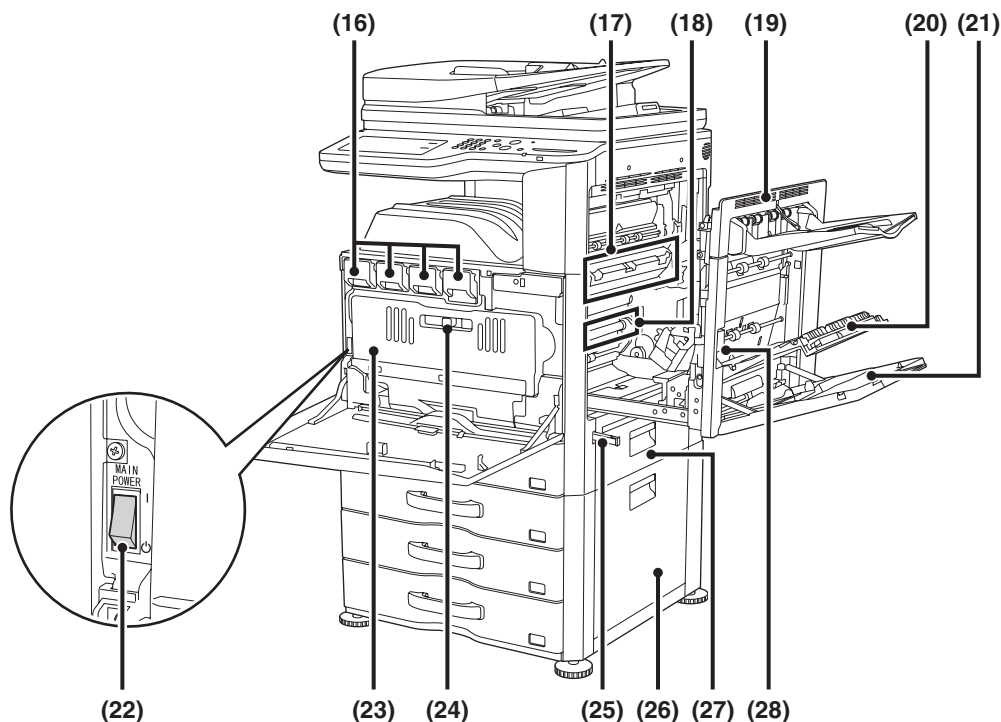

## (16) Toner cartridges

These contain toner for printing. When the toner runs out in a cartridge, the cartridge of the colour that ran out must be replaced.

➤ [REPLACING THE TONER CARTRIDGES](#) (page 1-64)

## (17) Fusing unit

Heat is applied here to fuse the transferred image onto the paper.



### Caution

The fusing unit is hot. Take care not to burn yourself when removing a paper misfeed.

## (18) Transfer belt

During full colour printing, the toner images of each of the four colours on each of the photoconductive drums are combined together on the transfer belt. During black and white printing, only the black toner image is transferred onto the transfer belt.



Do not touch or damage the transfer belt. This may cause a defective image.

## (19) Right side cover

Open this cover to remove a misfeed.

## (20) Paper reversing section cover

This is used when 2-sided printing is performed. Open this cover to remove a paper misfeed.

## (21) Bypass tray

Use this tray to feed paper manually. When loading a large sheet of paper, be sure to pull out the bypass tray extension.

➤ [LOADING PAPER IN THE BYPASS TRAY](#) (page 1-35)

## (22) Main power switch

This is used to power on the machine.

When using the fax or Internet fax functions, keep this switch in the "on" position.

➤ [TURNING THE POWER ON AND OFF](#) (page 1-15)

## (23) Waste toner box

This collects excess toner that remains after printing.

➤ [REPLACING THE WASTE TONER BOX](#) (page 1-67)



Your service technician will collect the waste toner box.

## (24) Waste toner box release lever

Move this lever when you need to release the waste toner box lock to replace the waste toner box or clean the laser unit.

➤ [CLEANING THE LASER UNIT](#) (page 1-60)

➤ [REPLACING THE WASTE TONER BOX](#) (page 1-67)

## (25) Handle

Pull this out and grasp it when moving the machine.

## (26) Right cover of paper drawer (when a paper drawer is installed)

Open this to remove a paper misfeed in tray 2, tray 3 or tray 4.

## (27) Paper tray right side cover

Open this to remove a paper misfeed in tray 1.

## (28) Right side cover release lever

To remove a paper misfeed, pull and hold this lever up to open the right side cover.

# AUTOMATIC DOCUMENT FEEDER AND DOCUMENT GLASS

## Automatic document feeder

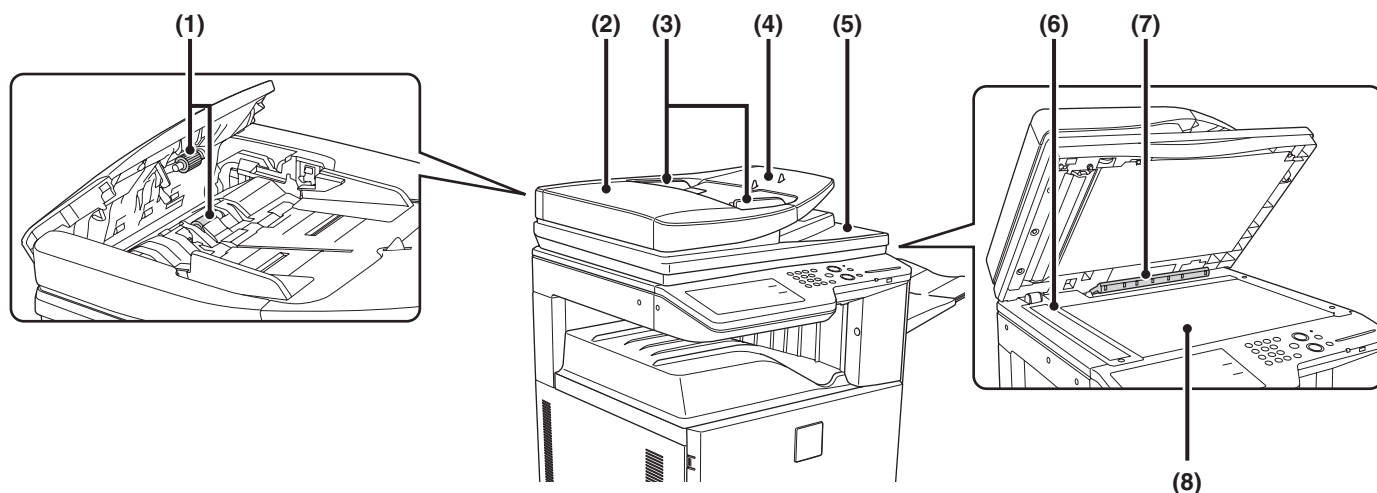

**(1) Paper feed roller**

This roller rotates to automatically feed the original.

**(2) Document feeding area cover**

Open this cover to remove an original misfeed or clean the paper feed roller.

**(3) Original guides**

These help ensure that the original is scanned correctly. Adjust the guides to the width of the original.

➤ [PLACING THE ORIGINAL](#) (page 1-38)

**(4) Document feeder tray**

Place originals in this tray. 1-sided originals must be placed face up.

➤ [PLACING THE ORIGINAL](#) (page 1-38)

**(5) Original exit tray**

Originals are delivered to this tray after scanning.

**(6) Scanning area**

Originals placed in the document feeder tray are scanned here.

➤ [REGULAR MAINTENANCE](#) (page 1-52)

**(7) Original size detector**

This detects the size of an original placed on the document glass.

➤ [PLACING THE ORIGINAL ON THE DOCUMENT GLASS](#) (page 1-40)

**(8) Document glass**

Use this to scan a book or other thick original that cannot be fed through the automatic document feeder.

➤ [PLACING THE ORIGINAL ON THE DOCUMENT GLASS](#) (page 1-40)

## SIDE AND BACK

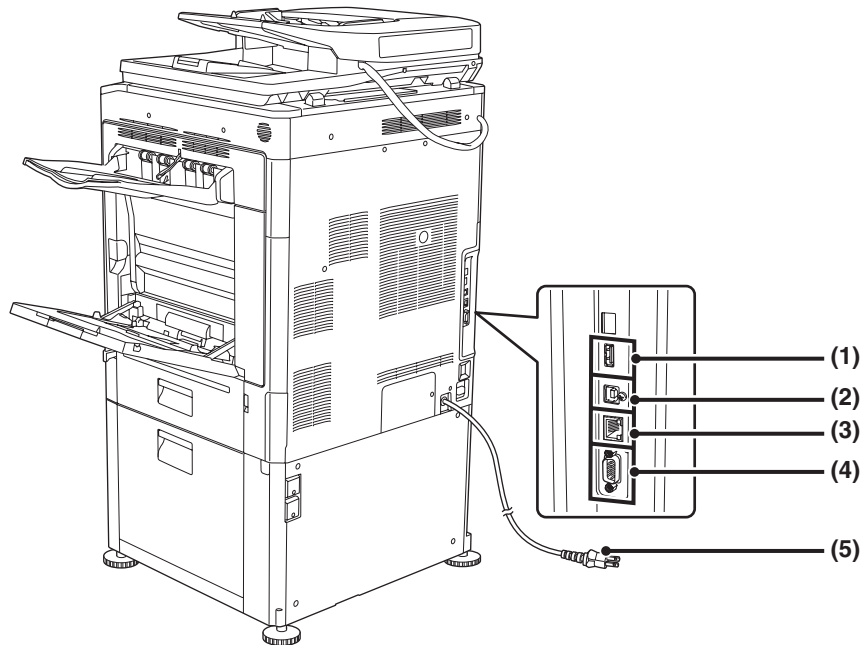

**(1) USB connector (A type)**

Supports USB 2.0 (Hi-Speed).  
This is used to connect a USB device such as USB memory to the machine.

**(2) USB connector (B type )**

Supports USB 2.0 (Hi-Speed).  
A computer can be connected to this connector to use the machine as a printer.  
For the USB cable, use a shielded cable.

**(3) LAN connector**

Connect the LAN cable to this connector when the machine is used on a network.  
For the LAN cable, use a shielded type cable.

**(4) Service-only connector**

**When the fax expansion kit is installed**

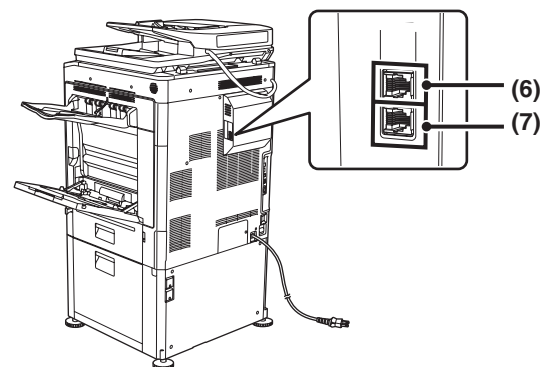

**⚠ Caution**

This connector is for use only by service technicians.  
Connecting a cable to this connector may cause the machine to malfunction.

**Important note for service technicians:**  
The cable connected to the service connector must be less than 3 m (118") in length.

**(5) Power plug**

**(6) Extension phone socket**

When the fax function of the machine is used, an extension phone can be connected to this socket.

**(7) Telephone line socket**

When the fax function of the machine is used, the telephone line is connected to this socket.



# OPERATION PANEL

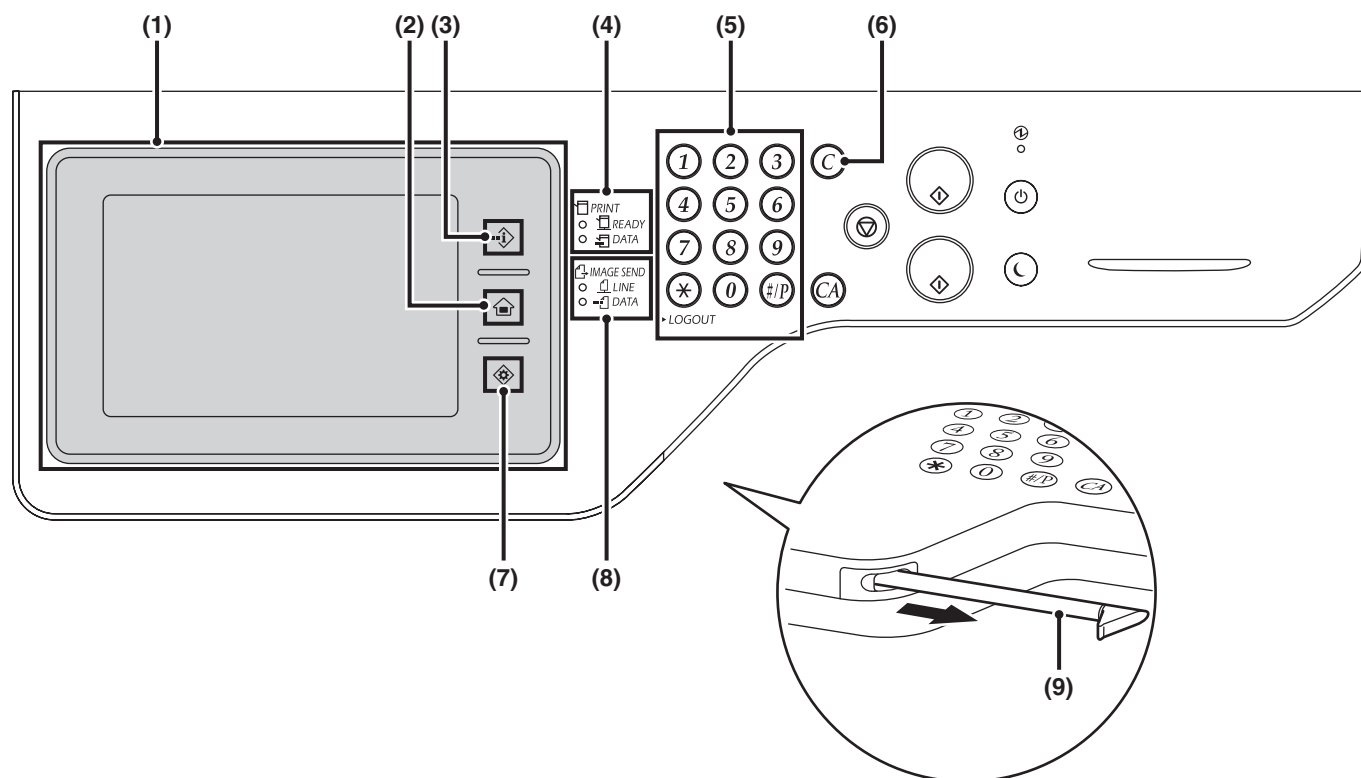

## (1) Touch panel

Messages and keys appear in the touch panel display. Touch the displayed keys to perform a variety of operations. The [HOME] (🏠), [JOB STATUS] (📄), and [SYSTEM SETTINGS] (⚙️) keys are also available here. When a key is touched, a beep sounds and the selected item is highlighted. This provides confirmation as you perform an operation.

📖 [TOUCH PANEL](#) (page 1-10)

## (2) [HOME] key (🏠)

Touch this key to display the home screen. Frequently used settings can be registered in the home screen to enable quick and easy operation of the machine.

📖 [HOME SCREEN](#) (page 1-22)

## (3) [JOB STATUS] key (📄)

Touch this key to display the job status screen. The job status screen is used to check information on jobs and to cancel jobs.

For details, see the chapters for each of the functions in this manual.

## (4) PRINT mode indicators (📄)

### • READY indicator

Print jobs can be received when this indicator is lit.

### • DATA indicator

This blinks while print data is being received and lights steadily while printing is taking place.

## (5) Numeric keys

These are used to enter the number of copies, fax numbers, and other numerical values. These keys are also used to enter numeric value settings (except for the system settings).

## (6) [CLEAR] key (⊘)

Press this key to return the number of copies to "0".

## (7) [SYSTEM SETTINGS] key (⚙️)

Touch this key to display the system settings menu screen. The system settings are used to configure paper tray settings, store addresses for transmission operations, and adjust parameters to make the machine easier to use.

## (8) IMAGE SEND mode indicators (📄)

### • LINE indicator

This lights up during transmission or reception of a fax or Internet fax. This also lights during transmission of an image in scan mode.

### • DATA indicator

This blinks when a received fax or Internet fax cannot be printed because of a problem such as out of paper. This lights up when there is a transmission job that has not been sent.

## (9) Stylus pen

This can be used to touch a key displayed on the touch panel.

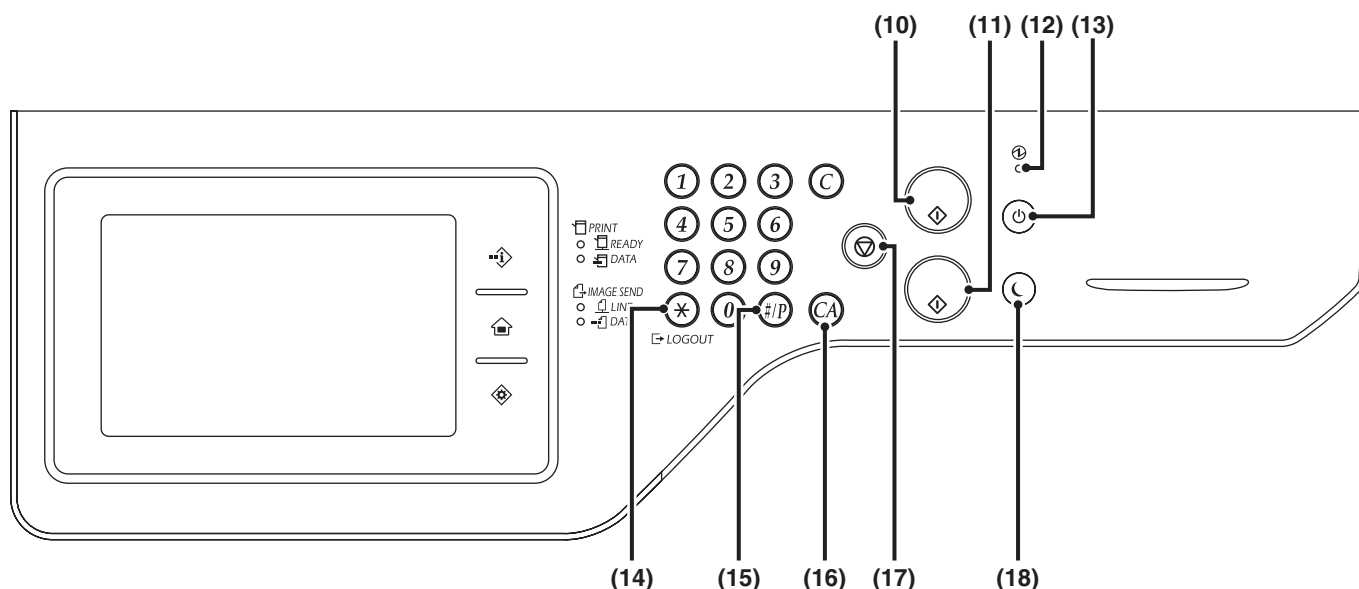
**(10) [COLOUR START] key**

Press this key to copy or scan an original in colour.  
This key cannot be used for fax or Internet fax.

**(11) [BLACK & WHITE START] key**

Press this key to copy or scan an original in black and white. This key is also used to send a fax in fax mode.

**(12) Main power indicator**

This lights up when the machine's main power switch is in the "on" position.

➤ [TURNING THE POWER ON AND OFF](#) (page 1-15)

**(13) [POWER] key (⏻)**

Use this key to turn the machine power on and off.

➤ [TURNING THE POWER ON AND OFF](#) (page 1-15)

**(14) [LOGOUT] key (✖)**

Press this key to log out after you have logged in and used the machine. When using the fax function, this key can also be pressed to send tone signals on a pulse dial line.

➤ [USER AUTHENTICATION](#) (page 1-17)

**(15) [#]/P key (Ⓜ)**

When using the copy function, press this key to use a job program. When using the fax function, this key can be used when dialling.

**(16) [CLEAR ALL] key (CA)**

Press this key to return to the initial operation state. Use this key when you wish to cancel all settings that have been selected and start operation from the initial state.

**(17) [STOP] key (⏹)**

Press this key to stop a copy job or scanning of an original.

**(18) [POWER SAVE] key (⏻) / indicator**

Use this key to put the machine into auto power shut-off mode to save energy.

The [POWER SAVE] key (⏻) blinks when the machine is in auto power shut-off mode.

➤ [\[POWER SAVE\] KEY](#) (page 1-16)



The indicators of the operation panel may differ depending on the country and region.

# TOUCH PANEL

This section explains how to use the touch panel.

Messages and keys are displayed in the touch panel display to enable various operations to be performed.

The [JOB STATUS] (⇄), [HOME] (🏠), and [SYSTEM SETTINGS] (⬢) keys are also available on the touch panel.

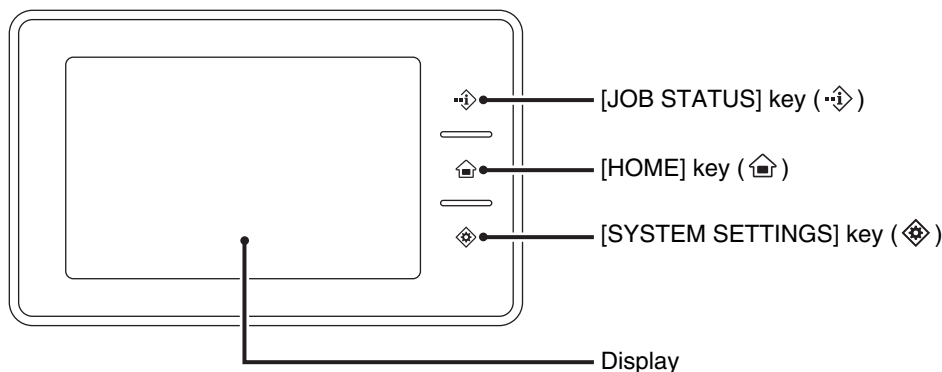

- To enter text, see "[ENTERING TEXT](#)" (page 1-70).
- Touch the [JOB STATUS] key (⇄) to display the job status screen. For details, see the chapters for each of the function in this manual.
- For details about the [HOME] key (🏠), see "[HOME SCREEN](#)" (page 1-22).
- Touch the [SYSTEM SETTINGS] key (⬢) to display the system settings menu screen. For information on the screens and procedures for using the system settings, see "[Common Operation Methods](#)" (page 7-4) in "7. SYSTEM SETTINGS".

 When you operate the touch panel, do not accidentally touch areas in the touch panel that are not necessary for the intended operations.  
If touched, the machine may malfunction.

## Using the touch panel display

### Example 1

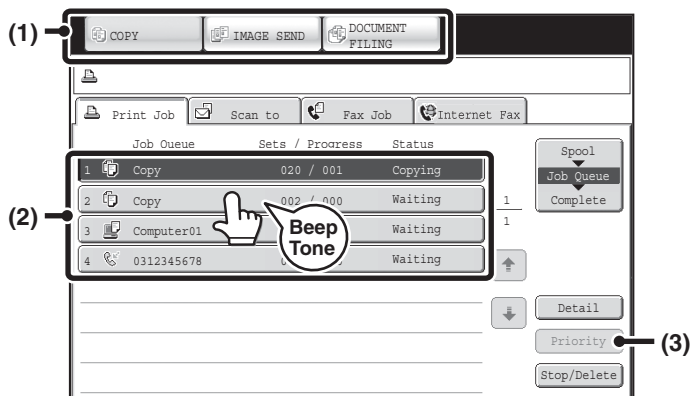

#### (1) Mode select keys

Use these keys to switch between copy, image send, and document filing modes\*.

\* On the MX-2314N, the productivity kit is required. If the productivity kit is not installed, the mode used will be print mode.

#### (2) Settings for each function are easily selected and cancelled by touching the keys on the screen with your finger.

When an item is selected, a beep will sound and the item will be highlighted to confirm the selection.

#### (3) Keys that are greyed out cannot be selected.

 If you touch a key that cannot be selected, a double beep will sound.

**Example 2**

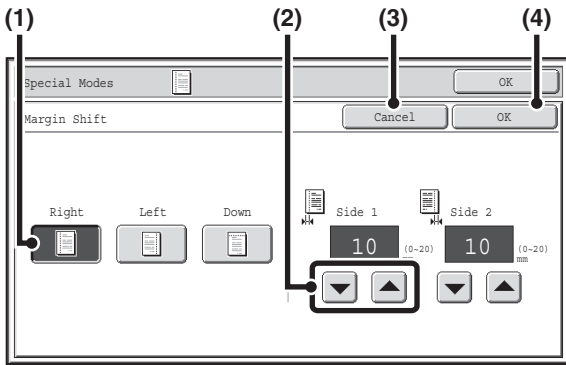

- (1) If the initial state of a key in a screen is highlighted, the key is selected. To change the selection, touch one of the other keys to highlight that key.
- (2) The keys can be used to increase or decrease a value. To make a value change quickly, keep your finger on the key.
- (3) Touch this key to cancel a setting.
- (4) Touch the [OK] key to enter and save a setting.

**Example 3**

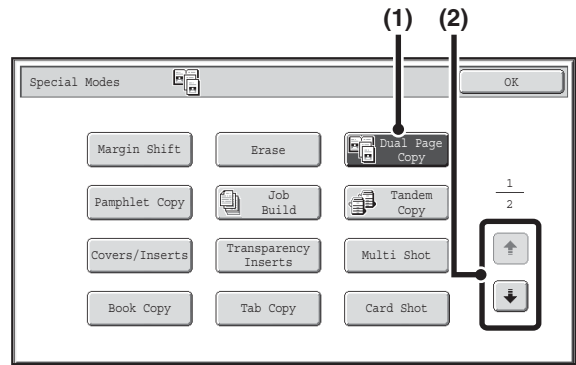

- (1) Some items in the special modes screen are selected by simply touching the key of the item. To cancel a selected item, touch the highlighted key once again so that it is no longer highlighted.
- (2) When settings extend over multiple screens, touch the key or the key to switch through the screens.

**Example 4**

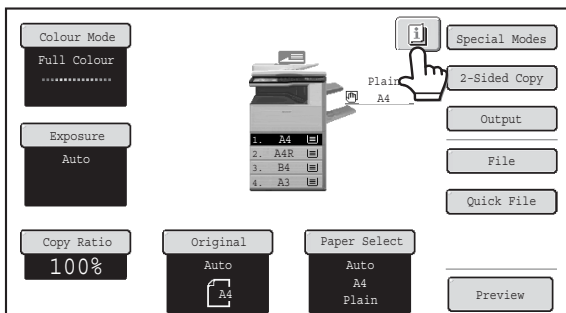

When at least one special mode is selected, the key appears in the base screen.

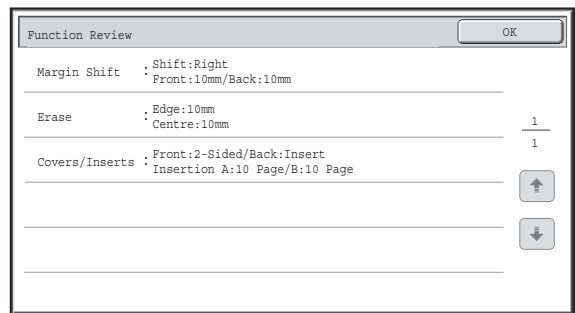

The key can be touched to display a list of the selected special modes.

**Example 5**

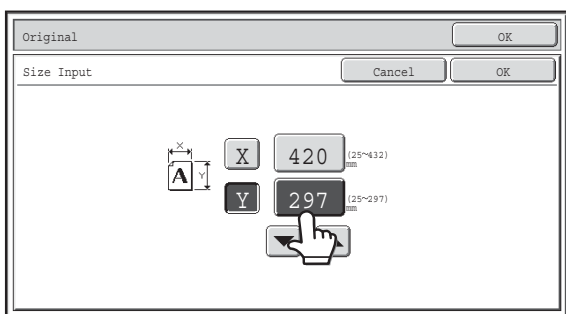

Touch a numeric value display key to directly enter a value with the numeric keys.

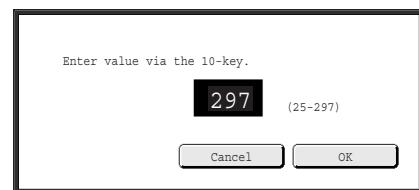

Press the numeric keys to enter any numeric value and then touch the [OK] key.

The touch panel (screen) shown in this manual is a descriptive image. The actual screen is slightly different.

**System Settings (Administrator): Keys Touch Sound**  
This is used to adjust the volume of the beep that sounds when keys are touched. The key touch sound can also be turned off.

# STATUS DISPLAY

When the base screen of a mode appears, the right side of the touch panel shows the machine's status. The information shown is explained below.

## Example: Basic screen of copy mode

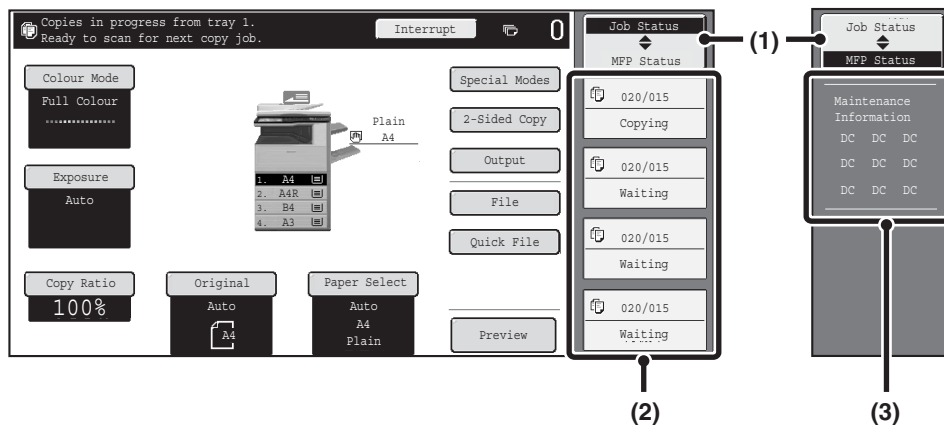

### (1) Display selection key

The status display can be switched between "Job Status" and "MFP Status".

If the job status screen is displayed, the status display automatically changes to "MFP Status".

### (2) "Job Status" display

This shows the first 4 print jobs in the print queue (the job in progress and jobs waiting to be printed). The type of job, the set number of copies, the number of copies completed, and the job status appear.

Jobs cannot be manipulated in this screen. Jobs can only be manipulated in the job status screen.

For details, see the chapters for each of the functions in this manual.

### (3) "MFP Status" display

This shows machine system information. "Maintenance Information"

This shows machine maintenance information by means of codes.

# SYSTEM BAR

The system bar appears at the bottom of the touch panel.  
The items that appear in the system bar are explained below.

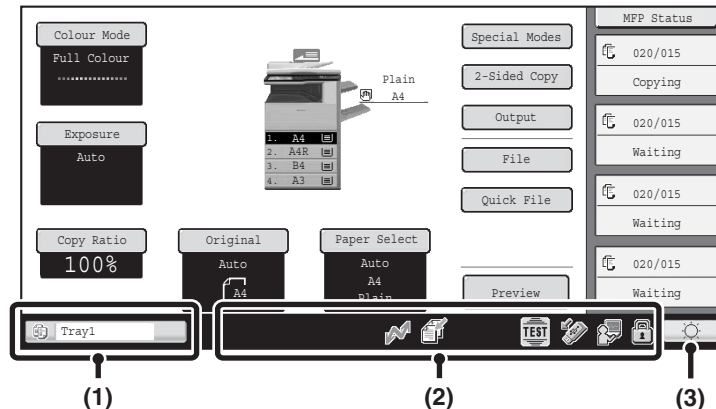

## (1) Job status display

The job in progress or reserved are indicated by icons.  
The icons are as follows.

	Print job		Copy job
	Scan to E-mail job		Scan to FTP job
	Scan to Network Folder job		Scan to Desktop job
	Fax transmission job		Fax reception job
	PC-Fax transmission job		Internet fax transmission job (Including Direct SMTP)
	Internet Fax reception job (Including Direct SMTP)		PC-I-Fax transmission job
	Broadcast job* Inbound routing job		Scan to HDD file print job
	Tandem copy/print job		Metadata send job

\* This appears in a multi-mode broadcast job.









When a base screen other than that of image send mode appears, the number of the tray being used to feed paper appears during paper feeding. The colour appearing in the job status display depends on the job status as indicated in the table below.

The job status display can be touched to show the job status screen.

Job status display	Machine Configuration
Green	A print, scan or other job is being executed normally.
Yellow	The machine is warming up or on standby, or a job is being cancelled.
Red	A paper misfeed or other error condition has occurred.
Grey	The machine has no jobs.

## (2) Icon display

	This icon appears when data is being sent or received.
	This icon appears when fax, scan, or Internet fax data is stored in the machine's memory. When data to be transmitted is stored,  appears. When received data is stored,  appears. When both data to be transmitted and received data are stored,  appears.
	This appears when a service technician has activated simulation mode.
	This appears when a USB memory or other USB device is connected to the machine.

	This appears when the data security kit is being used.
	The icon appears when the machine is communicating with an external application.
	This appears when the IC card reader is connected.
	This appears when the IC card reader is communicating with the machine.
	This appears when the IC card reader is not securely connected.
	When a wireless LAN USB adapter is connected to the machine <ul style="list-style-type: none"> <li>• : Connected to an access point</li> <li>• : Not connected to an access point</li> <li>• : Waiting in ad-hoc mode</li> </ul>

### (3) Brightness adjustment key

Touch this key to adjust the brightness of the touch panel.

When touched, the following screen appears next to the key.



Touch the [+] key or the [-] key to adjust the brightness.

When finished, touch the brightness adjustment key again to close the screen.

# TURNING THE POWER ON AND OFF

The machine has two power switches. The main power switch is at the lower left after the front cover is opened. The other power switch is the [POWER] key (⏻) on the operation panel at the top right.

## Main power switch

When the main power switch is switched on, the main power indicator on the operation panel lights up.

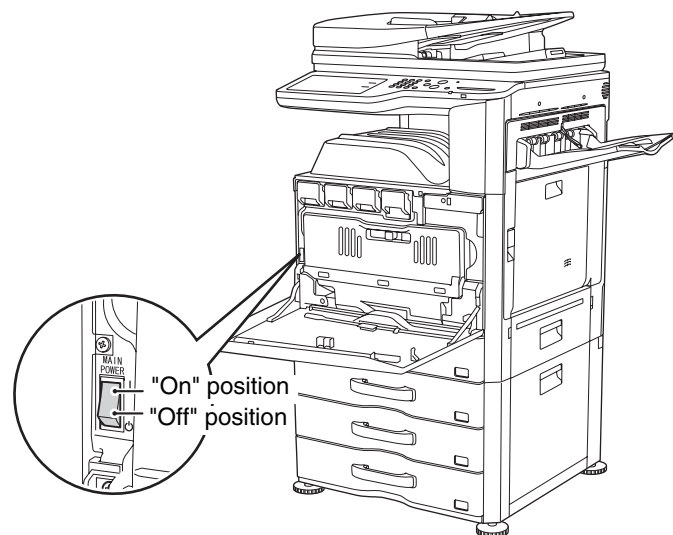

## [POWER] key

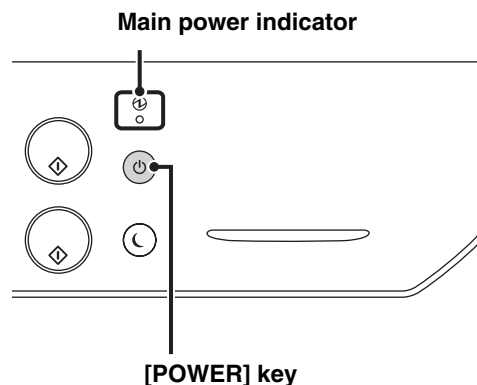

## Turning on the power

- (1) Switch the main power switch to the "on" position.
- (2) Press the [POWER] key (⏻) to turn on the power.

## Turning off the power

- (1) Press the [POWER] key (⏻) to turn off the power.
- (2) Switch the main power switch to the "off" position.

- ! If the main power indicator is blinking, press the [POWER] key (⏻) after it becomes steadily lit.
- When turning off the main power switch, ensure that each of the lamps on the operation panel has been turned off.
- In the event that the main power is suddenly interrupted due to a power failure or other reason, turn the machine power back on and then turn it off in the correct order. If the machine is left for a long time with the main power having been turned off prior to the [POWER] key (⏻), abnormal noises, degraded image quality, and other problems may result. Switching off the main power switch or removing the power cord from the outlet while any of the indicators are lit or blinking may damage the hard drive and cause data to be lost.
- Switch off both the [POWER] key (⏻) and the main power switch and unplug the power cord if you suspect a machine failure, if there is a bad thunderstorm nearby, or when you are moving the machine.

- ✎ When using the fax or Internet fax function, always keep the main power switch in the "on" position.

## Restarting the machine

In order for some settings to take effect, the machine must be restarted.

If a message in the touch panel prompts you to restart the machine, press the [POWER] key (⏻) to turn off the power and then press the key again to turn the power back on.

- ✎ In some states of the machine, pressing the [POWER] key (⏻) to restart will not make the settings take effect. In this case, use the main power switch to switch the power off and then on.



# ENERGY SAVE FUNCTIONS

This product has the following energy save functions that help conserve natural resources and reduce environmental pollution.

## Eco Scan Setting

Non-print functions such as image sending and document filing function can be executed while the fusing unit is kept Off.

## Power Management Setting

The power management setting includes preheat mode, auto power shut-off mode, and other functions that reduce power consumption while in a waiting state.

### Preheat Mode (Low power mode)

Preheat mode automatically lowers the temperature of the fusing unit and thereby reduces power consumption if the machine remains in the standby state for the interval of time set in "Preheat Mode Setting" in the system settings (administrator).

This keeps the fusing unit at a lower temperature and reduces power consumption while the machine is on standby. The machine automatically wakes up and returns to normal operation when a print job is received, a key is pressed on the operation panel, or an original is placed.

### Auto power shut-off mode (Sleep mode)

Auto power shut-off mode automatically shuts off power to the display and the fusing unit if the machine remains in the standby state for the interval of time set in "Auto Power Shut-Off Timer" in the system settings (administrator). This mode provides the lowest level of power consumption. Considerably more power is saved than in preheat mode, however, the wakeup time is longer. This mode can be disabled in the system settings (administrator).

The machine automatically wakes up and resumes normal operation when a print job is received or when the blinking [POWER SAVE] key (Ⓞ) is pressed.

## Power ON/OFF Schedule Setting

The power ON/OFF schedule setting is a function that sets the time to turn the machine on or off, helping reduce power consumption per day or per week. Configure this setting from [Power ON/OFF Schedule Setting] in the Web page menu.

## [POWER SAVE] KEY

Press the [POWER SAVE] key (Ⓞ) to put the machine in auto power shut-off mode or wake it up from auto power shut-off mode. The [POWER SAVE] key (Ⓞ) has an indicator that indicates whether or not the machine is in auto power shut-off mode.

<b>When the [POWER SAVE] key (Ⓞ) indicator is off in the standby state</b>	The machine is ready to be used. If the [POWER SAVE] key (Ⓞ) is pressed when the indicator is off, the indicator will blink and the machine will enter auto power shut-off mode after a brief interval.
<b>When the [POWER SAVE] key (Ⓞ) indicator is blinking</b>	The machine is in auto power shut-off mode. If the [POWER SAVE] key (Ⓞ) is pressed when the indicator is blinking, the indicator will turn off and the machine will return to the ready state after a brief interval.

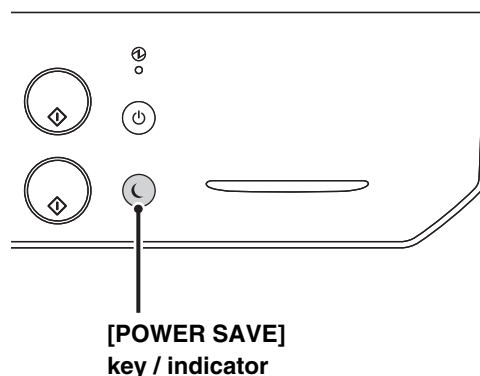

# USER AUTHENTICATION

User authentication restricts the use of the machine to users that have been registered. The functions that each user is allowed to use can be specified, allowing the machine to be customized to meet the needs of your workplace.

When the administrator of the machine has enabled user authentication, each user must log in to use the machine.

There are different types of user authentication, and each type has a different login method.

For more information, see the explanations of the login methods.

☞ [AUTHENTICATION BY USER NUMBER](#) (see below)

☞ [AUTHENTICATION BY LOGIN NAME / PASSWORD](#) (page 1-19)

## AUTHENTICATION BY USER NUMBER

The following procedure is used to log in using a user number received from the administrator of the machine.

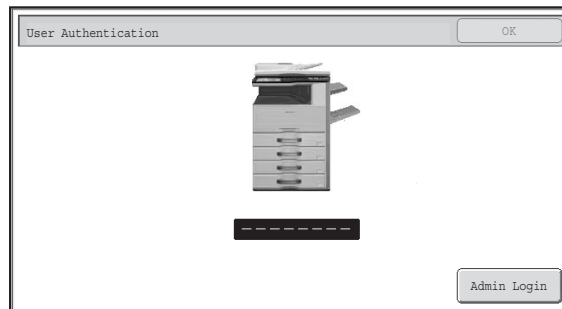

When controlled by user number

1

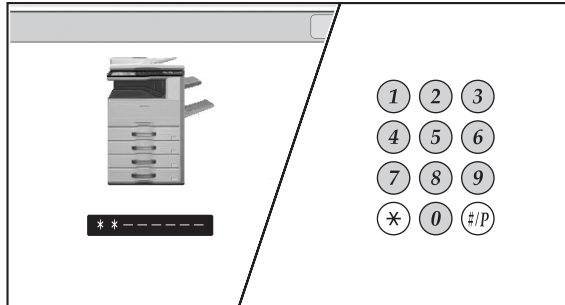

**Enter your user number (5 to 8 digits) with the numeric keys.**

Each entered digit will be displayed as "\*" .

2



### Touch the [OK] key.

After the entered user number is authenticated, the user count screen will appear briefly.

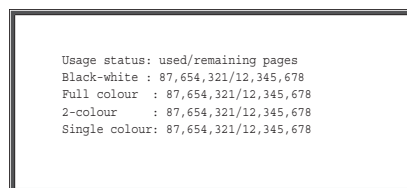

When page limits have been set in "Pages Limit Group List" in the system settings (administrator), the number of pages remaining will appear. (The remaining number of pages that the user can use in each mode (copy, scan, etc.) appears.) The amount of time that this screen appears can be changed using "Message Time Setting" in the system settings (administrator).



When the user number is an 8-digit number, this step is not necessary. (Login takes place automatically after the user number is entered.)

3

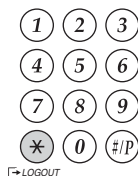

### When you have finished using the machine and are ready to log out, press the [LOGOUT] key (\*).



- However, note that the [LOGOUT] key (\*) cannot be used to log out when a fax number is being entered in fax mode, as the key is used for fax number entry.
- If a preset duration of time elapses after the machine is last used, the Auto Clear function will activate. When Auto Clear activates, logout takes place automatically. However, when PC Scan mode is used, logout does not take place when the [LOGOUT] key (\*) is pressed and Auto Clear does not operate. Change to a different mode on the machine and then log out.

### If an incorrect user number is entered 3 times in a row...

If "A Warning when Login Fails" is enabled in the system settings (administrator), the machine will lock for 5 minutes if an incorrect user number is entered 3 times in a row.

Verify the user number that you should use with the administrator of the machine.



The administrator can clear the locked state.  
This is done from [User Control] and then [Default Settings] in the Web page menu.

# AUTHENTICATION BY LOGIN NAME / PASSWORD

The following procedure is used to log in using a login name and password received from the administrator of the machine or the administrator of the LDAP server.

The screenshot shows a 'User Authentication' dialog box with the following elements:
 

- A title bar with 'User Authentication' and an 'OK' button.
- A 'Login Name' button and a user icon button.
- A text field labeled 'User Name :'. Below it is a 'Password' button.
- An 'Auth to:' dropdown menu currently set to 'Login Locally'.

## When controlled by login name and password

(Different items will appear in the screen when LDAP authentication is used.)

1

This screenshot is identical to the previous one, but a hand cursor is positioned over the 'Login Name' button, indicating the first step of the process.

## Touch the [Login Name] key or the key.

If the [Login Name] key is touched, a screen for selecting the user name appears. Go to the next step.

If the  key is touched, an area for entering a "Registration No." appears [---].

Use the numeric keys to enter your registration number that has been stored in "User List" in the system settings (administrator). After entering the registration number, go to step 3.

2

The screenshot shows a 'Device Account' screen with a 'Code User Selection' dialog box open. The dialog box has a 'Back' button and a list of users from 'User 0001' to 'User 0012'. Below the list is a keyboard with index tabs: 'All', 'ABCD', 'EFGH', 'IJKL', 'MNOP', 'QRSTU', 'VWXYZ', and 'etc.'. Labels (A) through (D) point to:
 

- (A) The 'Direct Entry' key on the left sidebar.
- (B) The user selection keys in the list.
- (C) The 'Back' button.
- (D) The 'All' index tab on the keyboard.

## Select the user name.

### (A) [Direct Entry] key

Use this key if you have not been stored in "User List" in the system settings (administrator) and are only using LDAP authentication.

A text entry screen will appear. Enter your login name.

### (B) User selection keys

Touch your user name that has been stored in "User List" in the system settings (administrator).

### (C) [Back] key

Touch this key to return to the login screen.

### (D) Index tabs

All users appear on the [All] tab. Users are grouped on the other tabs according to the search characters entered when each user was stored.



LDAP authentication can be used when the administrator of the server provides LDAP service on the LAN (local area network).

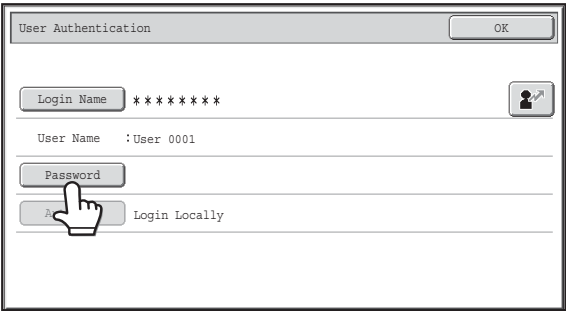

**Touch the [Password] key.**

A text entry screen for entering the password will appear. Enter your password that is stored in "User List" in the system settings (administrator).

If you are logging in to an LDAP server, enter the password that is stored with your LDAP server login name. Each entered character will be displayed as "\*". When you have finished entering the password, touch the [OK] key. When authentication is by LDAP server and you have different passwords stored in "User List" in the system settings (administrator) and in the LDAP server, use the password stored in the LDAP server.



- When an LDAP server has been stored, [Auth to:] can be changed.
- **If you are logging in using a user selection key...**  
The LDAP server was stored when your user information was stored, and thus the LDAP server will appear as the authentication server when you select your login name. Go to step 4.
- **When logging in using the [Direct Entry] key...**  
Touch the [Auth to:] key.

3

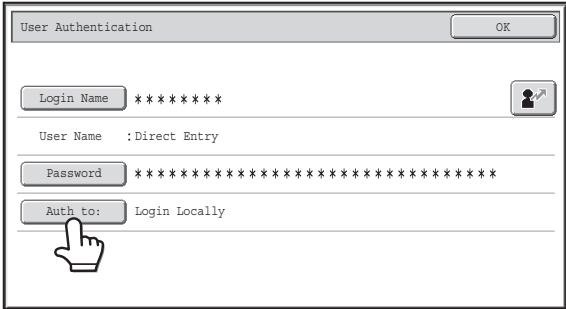

Select the LDAP server and touch the [OK] key.

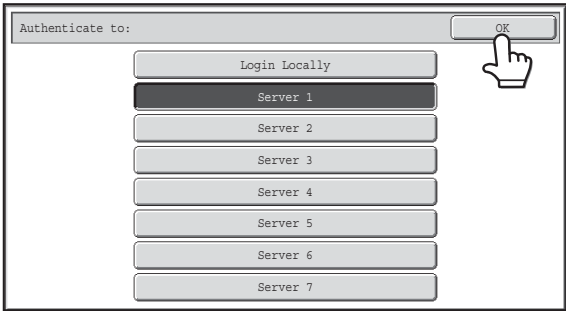

4

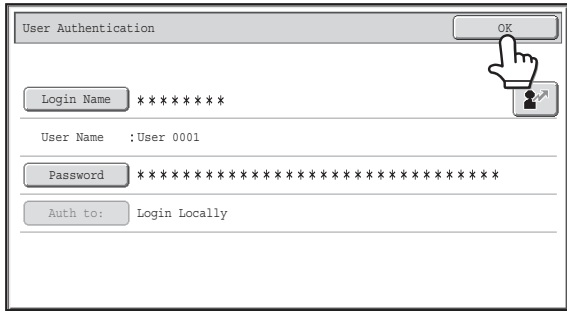

(Different items will appear in the screen when LDAP authentication is used.)

**Touch the [OK] key.**

After the entered login name and password are authenticated, the user count screen will appear briefly.

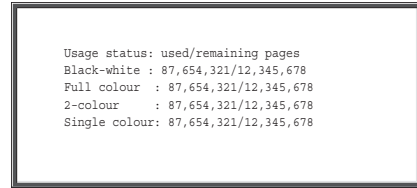

When page limits have been set in "Pages Limit Group List" in the system settings (administrator), the number of pages remaining will appear. (The remaining number of pages that the user can use in each mode (copy, scan, etc.) appears.) The amount of time that this screen appears can be changed using "Message Time Setting" in the system settings (administrator).

5



**When you have finished using the machine and are ready to log out, press the [LOGOUT] key (⊛).**



- However, note that the [LOGOUT] key (⊛) cannot be used to log out when a fax number is being entered in fax mode, as the key is used for fax number entry.
- If a preset duration of time elapses after the machine is last used, the Auto Clear function will activate. When Auto Clear activates, logout takes place automatically. However, when PC Scan mode is used, logout does not take place when the [LOGOUT] key (⊛) is pressed and Auto Clear does not operate. Change to a different mode on the machine and then log out.

**If an incorrect login name or password is entered 3 times in a row...**

If "A Warning when Login Fails" is enabled in the system settings (administrator), the machine will lock for 5 minutes if an incorrect login name or password is entered 3 times in a row.

Verify the login name and password that you should use with the administrator of the machine.



- The administrator can clear the locked state. This is done from [User Control] and then [Default Settings] in the Web page menu.
- When LDAP authentication is used, the [E-mail Address] key may appear, depending on the authentication method. If the [E-mail Address] key appears in step 3, touch the key. A text entry screen will appear. Enter your e-mail address.

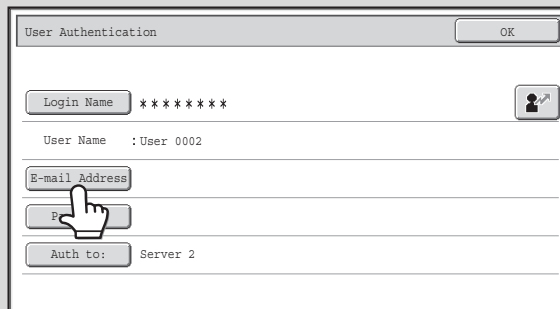

**System Settings (Administrator): User List**

This is used to store names of users of the machine. Detailed information such as the login name, user number, and password are also stored. Ask the administrator of the machine for the information that you need to use the machine.

# HOME SCREEN

When the [HOME] key (  ) is touched on the touch panel, the home screen appears in the touch panel. Mode selection keys appear in the home screen. These keys can be touched to open the base screen of each mode. The [My Menu] key can be touched to display shortcuts to functions stored in "My Menu".

1st screen

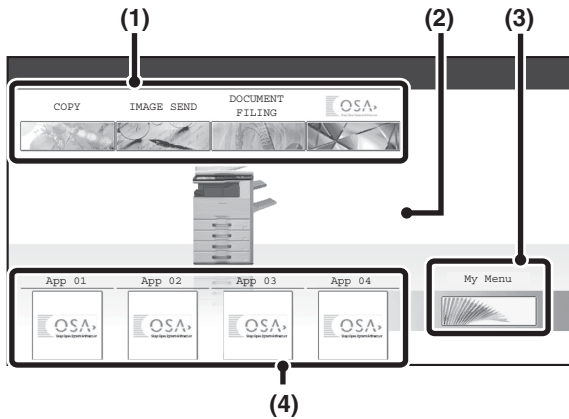

2nd screen

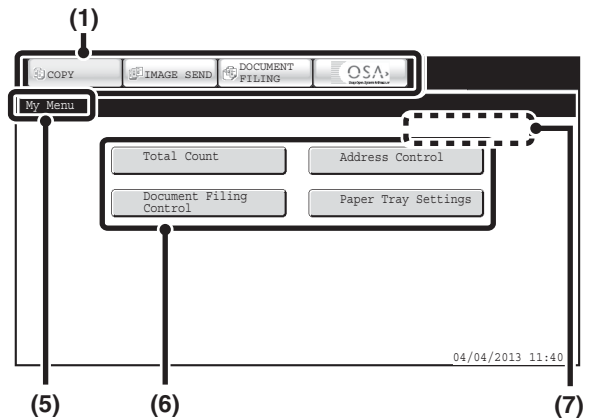

**(1) Mode select keys**

Use these keys to switch between copy, image send, document filing, and Sharp OSA modes. Key names and images can be changed. (1st screen only)

**(2) Background Image**

Background image of the home screen. The background image can be changed.

**(3) [My Menu] key**

Touch to go to your my menu screen. Key names and images can be changed.

**(4) Application Keys\***

It is possible to display a combined total of eight Sharp OSA application shortcuts and my menu shortcuts.

\* On the MX-2314N, the productivity kit is required.

**(5) Title**

This shows the title of the my menu screen.

**(6) Shortcut key**

A registered function appears as a shortcut key. The key can be touched to select the registered function.

**(7) User name**

This shows the name of the logged in user. The user name appears when user authentication is enabled on the machine.

Shortcuts to functions can be registered as keys in the my menu screen. When a shortcut key is touched, the screen for that function appears. Register frequently used functions in the my menu screen to quickly and conveniently access those functions. When user authentication is used, the my menu screen of "Favourite Operation Group" can be displayed.

Use the Web page to configure the following settings:

- Changing the name of the home screen key, changing the image, storing an application key
- Storing keys that appear in the my menu screen.



**• System Settings (Administrator): My Menu Settings**

Registration is performed in [System Settings] - [Operation Settings] - [My Menu Settings] in the Web page menu.

**• System Settings (Administrator): My Menu List**

When user authentication is enabled, a my menu screen can be set for each "Favourite Operation Group List". Registration is performed in "My Menu List" in [User Control] in the Web page menu.

# REMOTE OPERATION OF THE MACHINE

The remote operation function allows you to operate the machine from your computer.

When this function is added, the same screen as the operation panel screen appears on your computer. This allows you to operate the machine from your computer in the same way as if you were standing in front of the machine.

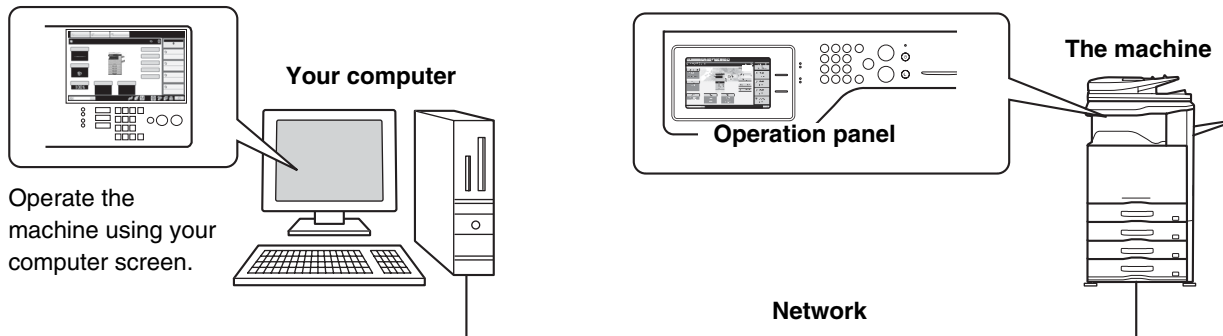

The remote operation function can only be used on one computer at a time.

## How to use the remote operation function

Before using this function, set "Operational Authority" to "Allowed" in "Remote Software Operation" of "Remote Operation Settings" in the system settings (administrator).

➤ 7. SYSTEM SETTINGS "Remote Operation Settings" (page 7-67)

To use the remote operation function, the machine must be connected to a network and a VNC application must be installed on your computer (recommended VNC software: RealVNC).

The procedure for using this function is as follows:

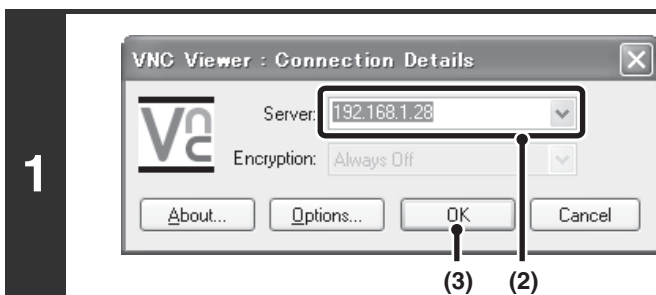

### Example: RealVNC





### Connect from the computer to the machine.

- (1) Start the VNC viewer
- (2) Enter the IP address of the machine in the "Server" entry box.
- (3) Click the [OK] button.

### 2 Follow the prompts on the operation panel of the machine to permit the connection.

When the machine is connected to the remote software,  appears on the system bar of the machine's touch panel. If you wish to disconnect, exit the remote software or touch .

 Use the operation panel in the same way as you would on the machine. Note that a key cannot be held down to continuously change a value being entered. For detailed procedures, see the chapters for each of the functions in this manual.

 **System Settings (Administrator): Remote Operation Settings**  
Set the operation authority for the remote operation function.



# ITEMS RECORDED IN THE JOB LOG

(On the MX-2314N, the productivity kit is required.)

The machine records the jobs that are performed in the job log.

The main information that is recorded in the job log is described below.



- To make it easy to total the usage counts of differently configured machines, the items recorded in the job log are fixed, regardless of what peripheral devices are installed or the objective of the recording.
- In some cases, job information may not be correctly recorded, such as when a power failure occurs during a job.

No.		Item name	Description
1	Main items	Job ID	The job ID is recorded. Job IDs appear in the log as consecutive numbers up to a maximum of 999999, after which the count resets to 1.
2		Job Mode	The job mode, such as copy or print.
3		Computer Name	The name of the computer that sent a print job.*
4		User Name	The user name when the user authentication function is used.
5		Login Name	The login name when the user authentication function is used.
6		Starting Date & Time	The date and time the job was started.
7		Completing Date & Time	The date and time the job was completed.
8		Black & White Total Count	For a print job, the total count is recorded. For a send job, the number of transmitted black & white pages is recorded. When a broadcast transmission is summarized, the total number of pages is recorded. For a scan to HDD job, the number of stored black & white pages is recorded.
9		Full Colour Total Count	For a print job, the total count is recorded. For a send job, the total number of transmitted full colour pages is recorded. When a broadcast transmission is summarized, the total number of pages is recorded. For a scan to HDD job, the number of stored full colour pages is recorded.
10		2-Colour Total Count	Indicates the total 2-colour count.
11		Single Colour Total Count	Indicates the total single colour count.
12		Count according to size	Counts by original/paper size in colour mode and black & white mode.
13		Number of sheets according to size	Indicates the sheet count by paper type.
14		Invalid Paper Count(Black & White)	Indicates the black & white invalid sheet count.
15		Invalid Paper Count(Colour)	Indicates the colour invalid sheet count.

No.		Item name	Description
16	Main items	Number of Reserved Sets	Number of specified sets or reserved destinations.
17		Number of Completed Sets	Number of completed sets or number of destinations to which transmission was successfully completed.
18		Number of Reserved Pages	Number of reserved original pages of a copy, print, scan job, or other job.
19		Number of Completed Pages	Number of completed pages of a set.
20		Result	The result of a job.
21		Error Cause	When an error occurs during a job, the cause of the error.
22	Print Job Related Item	Output	The output mode of a printed job.
23		Staple	The status of stapling.
24		Staple Count	The staple count.
25		Punch Count	The punch count.
26		Printer Tone	The tone used for a print job.
27	Image Send Related Item	Direct Address	Address of an image send job.
28		Sender Name	Sender name of an image send job.
29		Sender Address	Sender address of an image send job.
30		Transmission Type	Transmission type of an image send job.
31		Administrative Serial Number	Administrative serial number of an image send job.
32		Broadcast number	Broadcast number of an image send job.
33		Entry Order	Reservation order for broadcast transmission of an image send job. For a serial polling job, this is used to correlate communication with printing.
34		File Type	File format of an image send job.
35		Compression Mode/Compression Ratio	Compression mode and compression ratio of the file of an image send job.
36		Communication Time	Indicates the communication time of image send jobs.
37		Fax No.	Indicates the stored sender's number.
38	Document Filing Related Item	Document Filing	Status of document filing.
39		Storing Mode	Document filing storing mode.
40		File Name 2	File name of a file stored by document filing or retention print.*
41		Data Size [KB]	File size.
42	Common Functionality	Colour Setting	Colour mode selected by user.
43		Special Modes	Special modes selected when the job was executed.
44		File Name 2	Records the file names of print jobs.*

No.		Item name	Description	
45	Detailed Items	Original Size	Size of scanned original. For a document filing print job, the paper size of the file.	
46		Original Type	Original type (text, printed photo, etc.) set in the exposure settings screen.	
47		Paper Size	For a print job, the paper size. For a send job, the transmitted paper size. For a Scan to HDD job, the paper size of the stored file.	
48		Paper Type	The paper type used for printing.	
49		Paper Property: Disable Duplex	Indicates that duplex was disabled in "Paper Type".	
50		Paper Property: Fixed Paper Side	Indicates that fixed side was specified in "Paper Type".	
51		Paper Property: Disable Staple	Indicates that stapling was disabled in "Paper Type".	
52		Paper Property: Disable Punch	Indicates that punching was disabled in "Paper Type".	
53		Duplex Setup	Indicates the duplex setting.	
54		Resolution	Indicates the scanning resolution.	
55		Machine Item	Model Name	Indicates the model name of the machine.
56			Unit Serial Number	Indicates the serial number of the machine.
57			Name	Indicates the name of the machine that is set in the Web pages.
58			Machine Location	Indicates the installation location of the machine that is set in the Web pages.

\*In some environments this is not recorded.

# LOADING PAPER

## IMPORTANT POINTS ABOUT PAPER

This section provides information that you should know before loading paper in the paper trays. Be sure to read this section before loading paper.

### NAMES AND LOCATIONS OF TRAYS

The names of the trays are as follows.

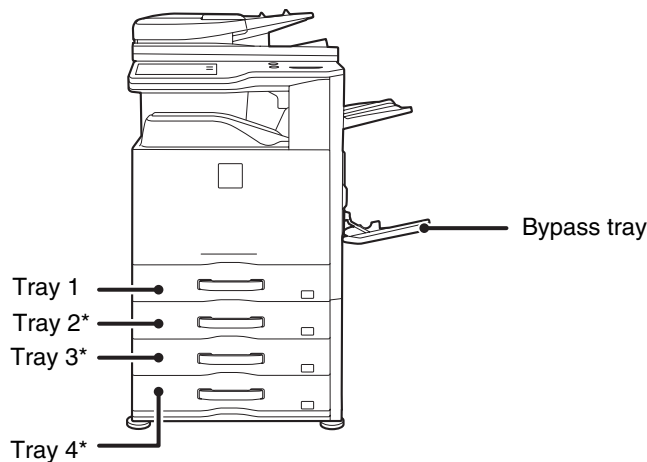

\*Optional paper drawer is installed.

### THE MEANING OF "R" IN PAPER SIZES

Some original and paper sizes can be placed in either the vertical or the horizontal orientation. To differentiate between vertical and horizontal orientations, paper sizes in the horizontal orientation will be followed by an "R" (for example, A4R, 8-1/2" x 11"R).

Sizes that can be placed only in the horizontal orientation (A3W, A3, B4, 12" x 18", 11" x 17", 8-1/2" x 14", 8-1/2" x 13") do not include the "R" in their size indication.

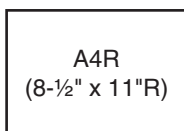

**Horizontal orientation**  
"R" is appended.

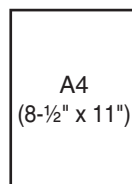

**Vertical orientation**  
"R" is not appended.

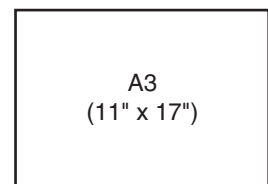

**Can be placed only in the horizontal orientation**  
"R" is not appended.

## USEABLE PAPER

Various types of paper are sold. This section explains what plain paper and what special media can be used with the machine. For detailed information on the sizes and types of paper that can be loaded in each tray of the machine, see the specifications in the Start Guide and "Paper Tray Settings" (page 7-13) in "7. SYSTEM SETTINGS".

### Plain paper, special media

#### Plain paper that can be used

- SHARP standard plain paper (80 g/m<sup>2</sup> (21 lbs.)). For paper specifications, see the specifications in the Start Guide.
- Plain paper other than SHARP standard paper (60 g/m<sup>2</sup> to 105 g/m<sup>2</sup> (16 lbs. to 28 lbs.))  
Recycled paper, coloured paper and pre-punched paper must meet the same specifications as plain paper. Contact your dealer or nearest authorised service representative for advice on using these types of paper.

#### Types of paper that can be used in each tray

The following types of paper can be loaded in each tray.

	Trays 1 to 4	Trays 3 to 4 (Stand/500&2000 sheet paper drawer)	Bypass tray
Plain paper	Permitted	Permitted	Permitted
Pre-printed	Permitted	Permitted	Permitted
Recycle Paper	Permitted	Permitted	Permitted
Letter head	Permitted	Permitted	Permitted
Pre-punched	Permitted	Permitted	Permitted
Colour	Permitted	Permitted	Permitted
Heavy paper 1*1	Permitted	–	Permitted
Heavy paper 2*2	–	–	Permitted
Heavy paper 3*3	–	–	Permitted
Labels	–	–	Permitted
Glossy paper	–	–	Permitted
Transparency film	–	–	Permitted
Tab paper	–	–	Permitted
Envelopes	–	–	Permitted
Thin paper*4	–	–	Permitted

\*1 Heavy Paper 1: 106 g/m<sup>2</sup> to 220 g/m<sup>2</sup> (28 lbs bond to 80 lbs cover) heavy paper

\*2 Heavy Paper 2: 221 g/m<sup>2</sup> to 256 g/m<sup>2</sup> (80 lbs cover to 140 lbs index) heavy paper

\*3 Heavy Paper 3: 257 g/m<sup>2</sup> to 300 g/m<sup>2</sup> (140 lbs index to 110 lbs cover) heavy paper

\*4 Thin paper from 55 g/m<sup>2</sup> to 59 g/m<sup>2</sup> (13 lbs. bond to 16 lbs. bond) can be used.

## Print side face up or face down

Paper is loaded with the print side face up or face down depending on the paper type and tray.

### Trays 1 to 4

Load the paper with the print side face up.

However, if the paper type is "Letter Head" or "Pre-Printed", load the paper with the print side face down\*.

### Trays 3 to 4 (Stand/500&2000 sheet paper drawer)

Load the paper with the print side face up.

However, if the paper type is "Letter Head" or "Pre-Printed", load the paper with the print side face down\*.

### Bypass tray

Load the paper with the print side face down.

However, if the paper type is "Letter Head" or "Pre-Printed", load the paper with the print side face up\*.

\* If "Disabling of Duplex" is enabled in the system settings (administrator), load the paper in the normal way (face up in trays 1 to 4; face down in the bypass tray).

## Paper that cannot be used

- Special media for inkjet printers (fine paper, glossy paper, glossy film, etc.)
- Carbon paper or thermal paper
- Pasted paper
- Paper with clips
- Paper with fold marks
- Torn paper
- Oil-feed transparency film
- Thin paper less than 55 g/m<sup>2</sup> (15 lbs.)
- Paper that is 300 g/m<sup>2</sup> (110 lbs.) or heavier
- Irregularly shaped paper
- Stapled paper
- Damp paper
- Curled paper
- Paper on which either the print side or the reverse side has been printed on by another printer or multifunction device.
- Paper with a wave-like pattern due to moisture absorption

## Non-recommended paper

- Iron-on transfer paper
- Japanese paper
- Perforated paper

-  Various types of plain paper and special media are sold. Some types cannot be used with the machine. Contact your dealer or nearest authorised service representative for advice on using these types of paper.
- The image quality and toner fusibility of paper may change due to ambient conditions, operating conditions, and paper characteristics, resulting in image quality inferior to that of SHARP standard paper. Contact your dealer or nearest authorised service representative for advice on using these types of paper.
  - The use of non-recommended or prohibited paper may result in skewed feeding, misfeeds, poor toner fusing (the toner does not adhere to the paper well and can be rubbed off), or machine failure.
  - The use of non-recommended paper may result in misfeeds or poor image quality. Before using non-recommended paper, check if printing can be performed properly.

# TRAY SETTINGS FOR TRAY 1 TO 4

## LOADING PAPER AND CHANGING THE PAPER SIZE

A maximum of 500 sheets of paper from size A5R to A3 (5-1/2" x 8-1/2"R to 11" x 17") can be loaded in trays 1 to 4.

1

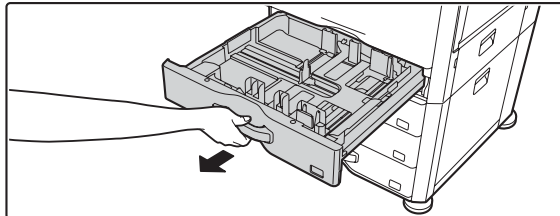

### Pull out the paper tray.

Gently pull the tray out until it stops.

To load paper, go to step 3. To load a different size of paper, go to the next step.

2

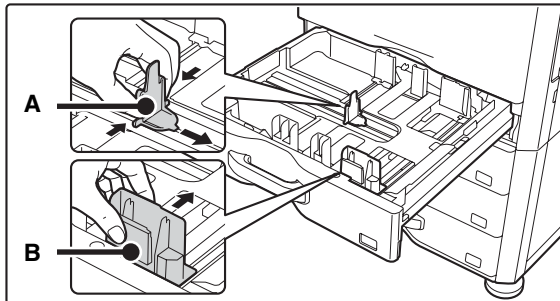

### Adjust the guide plates A and B by squeezing their lock levers and sliding them to match the vertical and horizontal dimensions of the paper to be loaded.

The guide plates A and B are slidable. Slide each guide plate while squeezing its lock lever.

3

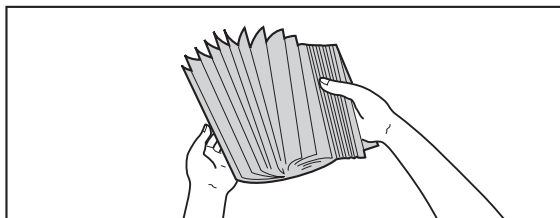

### Fan the paper.

Fan the paper well before loading it. If the paper is not fanned, multiple sheets may feed at once and cause a misfeed.

4

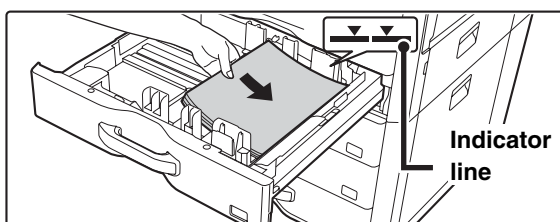

### Insert the paper into the tray.

Load the paper with the print side face up. The stack must not be higher than the indicator line (maximum of 500 sheets).

5

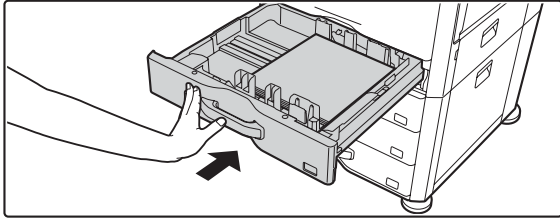
**Gently push the paper tray into the machine.**

Push the tray firmly all the way into the machine.



If you loaded a different type or size of paper than was loaded previously, be sure to change the "Paper Tray Settings" in the system settings. If these settings are not configured correctly, automatic paper selection will not operate correctly and printing may take place on the wrong size or type of paper, or a misfeed may occur.



Do not place heavy objects on the tray or press down on the tray.



**System Settings:** [Paper Tray Settings](#) (page 7-13)

Change these settings when you change the size or type of paper loaded in a tray.



# TRAY SETTINGS FOR TRAY 3 TO 4 (Stand/500&2000 Sheet Paper Drawer)

## LOADING PAPER IN PAPER TRAY 3 - TRAY 4

A4 or 8-1/2" x 11" size paper can be loaded in tray 3 and tray 4. These are parallel large-capacity trays that allow a total of approximately 2000 sheets of SHARP standard paper (80 g/m<sup>2</sup> (20lbs.)) to be loaded. If you wish to change the paper size of tray 3 or tray 4, see "[CHANGING THE PAPER SIZE IN PAPER TRAY 3 - TRAY 4](#)" on the next page.

For information on how to load paper and change the paper size for a single tray, see "[TRAY SETTINGS FOR TRAY 1 TO 4](#)" (page 1-30).

1

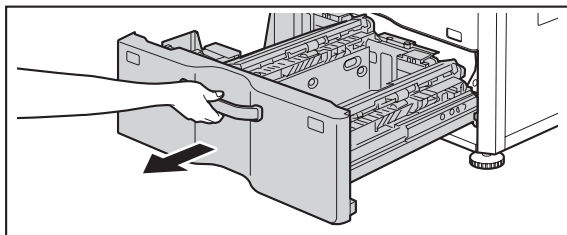

### Pull out paper tray 3-tray 4.

Gently pull the tray out until it stops.

2

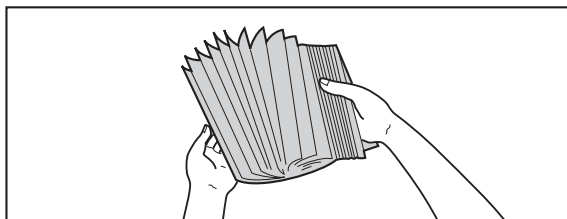

### Fan the paper.

Fan the paper well before loading it. If the paper is not fanned, multiple sheets may feed at once and cause a misfeed.

3

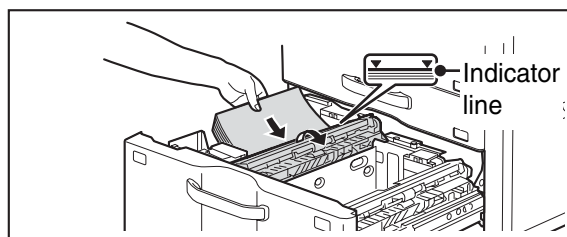

### Load paper in the left and right trays.

Lift the paper guide and load paper in tray 3.\*1

Approximately 1150 sheets of SHARP standard paper (80 g/m<sup>2</sup> (20lbs.)) can be loaded.

Be sure to return the paper guide to its original position after loading the paper.

Lift the paper guide and load paper in tray 4.\*1

Approximately 850 sheets of SHARP standard paper (80 g/m<sup>2</sup> (20lbs.)) can be loaded.

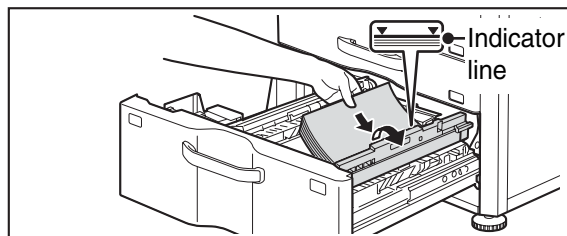

\*1 The paper stack must not be higher than the indicator line.

4

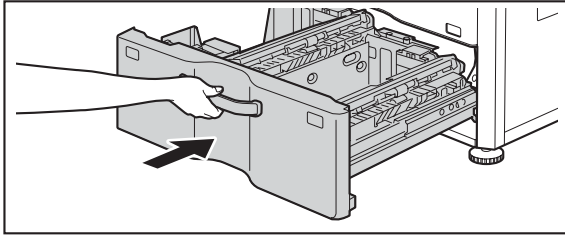

**Gently push tray 3-tray 4 into the machine.**

Push the tray firmly all the way into the machine.

5

### Set the paper type.

If the paper size was changed from an AB size to an inch size, or from an inch size to an AB size, or if the paper type was changed, be sure to change the appropriate settings as explained in "Paper Tray Settings" (page 7-13) in the System Settings.

6

Loading paper in paper tray 3/tray 4 is now complete.

## CHANGING THE PAPER SIZE IN PAPER TRAY 3 - TRAY 4

To change the paper size of tray 3 - tray 4, follow the steps below.

This section only explains how to change the paper size. For the procedures for opening/closing the tray and loading paper, see "LOADING PAPER IN PAPER TRAY 3 - TRAY 4" (page 1-32).

1

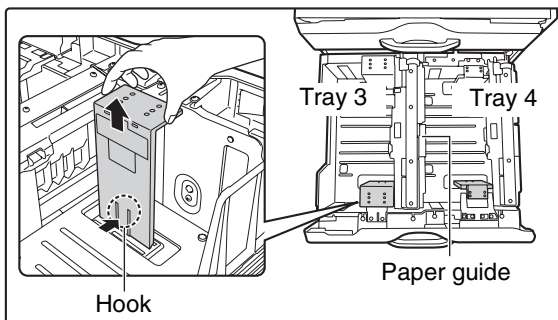

### Remove the paper size guide.

With the base of the tray pressed all the way down, hold down the hook at the bottom on the paper size guide and pull the paper size guide up slightly.



- Do not place heavy objects on the tray or press down on the tray.
- Before changing the paper size of tray 1, raise the paper guide.

2

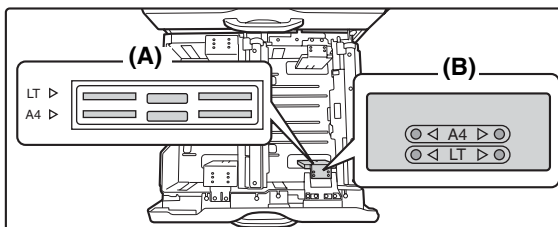

### Adjust the paper size guide to the paper size to be used.

Paper sizes are inscribed at the slot (A) on the bottom of the tray and at the hole (B) at the top of the paper size guide. ("LT" indicates 8-1/2" x 11" size.)

Align the bottom of the paper size guide with the slot, and align the hole at the top with the locking tab.



- When attaching the paper size guide, make sure that the top and bottom of the guide are aligned to the same paper size.
- If the top and bottom of the paper size guide are not aligned to the same paper size, skewed feeding and misfeeds will result.

3

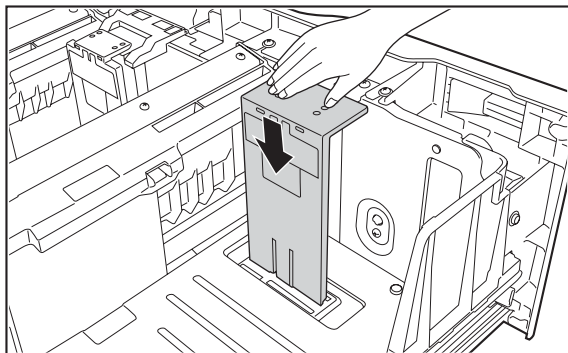

**Push in the paper guide so that it locks into place.**

Push the paper size guide in until the hook at the bottom locks into place. (You will hear a "click" when the hook locks.) Move the paper size guide slightly to verify that it has locked into place.

4

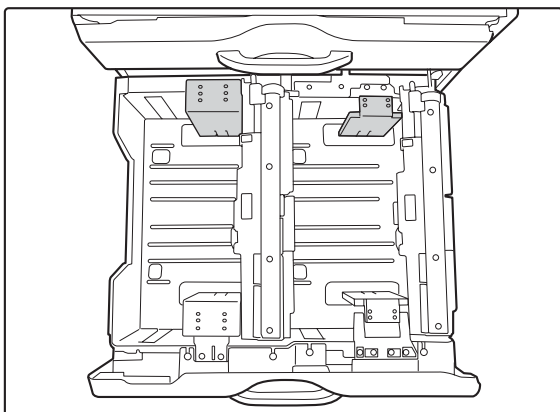

**Repeat steps 1 to 3 to adjust the far paper guide to the paper size to be used.**

Be sure to adjust the far paper guide to the same size as the near paper guide.



- When removing and attaching the far paper size guide, take care not to hit the front cover of the machine.
- Adjust both the front and back guides. If only one guide is adjusted, skewed feeding and misfeeds may result.

5

**Set the paper type and paper size.**

For the procedure for configuring these settings, see "[Paper Tray Settings](#)" (page 7-13) in the System Settings. An incorrect paper type or paper size setting may cause automatic selection of the wrong type or size of paper, and result in a misfeed or otherwise prevent printing.

<b>Model</b>	MX-DE20
<b>Paper sizes</b>	Tray 2: A3 (11" x 17") to A5R (5-1/2" x 8-1/2"R) Tray 3: A4 (8-1/2" x 11") Tray 4: A4 (8-1/2" x 11")
<b>Paper capacity</b>	Tray 2: 500 Tray 3: 1150 Tray 4: 850
<b>Dimensions</b>	583 mm (W) x 577 mm (D) x 382 mm (H) (22-61/64" (W) x 22-46/64" (D) x 15-1/64" (H))
<b>Weight</b>	Approx. 30 kg (66.2 lbs.)

# LOADING PAPER IN THE BYPASS TRAY

The bypass tray can be used to print on plain paper, envelopes, label sheets, tab paper, and other special media. Up to 100 sheets of paper can be loaded (up to 40 sheets of heavy paper) for continuous printing similar to the other trays.

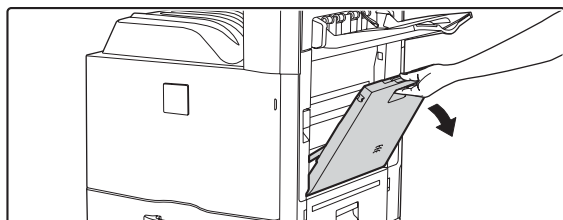

**Open the bypass tray.**

1

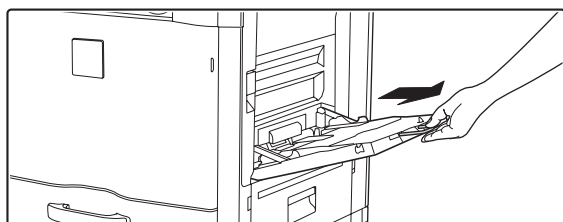

When loading a large sheet of paper, be sure to pull out the bypass tray extension. Pull the bypass tray extension all the way out.



Do not place heavy objects on the bypass tray or press down on the tray.

2

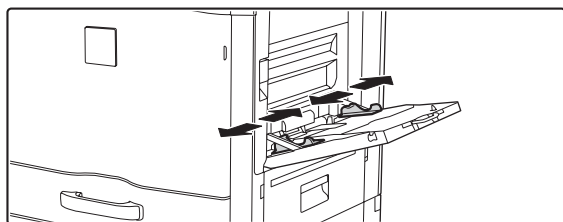

**Set the bypass tray guides to the width of the paper.**

3

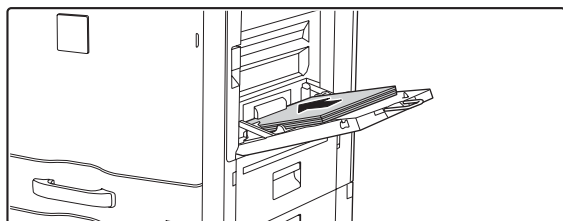

**Insert the paper along the bypass tray guides all the way into the bypass tray until it stops.**

Load the paper with the print side face down.



- Do not force the paper in.
- If the bypass tray guides are set wider than the paper, move the bypass tray guides in until they correctly fit the width of the paper. If the bypass guides are set too wide, the paper may skew or be creased.

## IMPORTANT POINTS WHEN USING THE BYPASS TRAY

- When using plain paper other than SHARP standard paper or special media other than SHARP-recommended transparency film, or when printing on the reverse side of previously used paper, the paper must be loaded one sheet at a time. Loading more than one sheet at a time will cause misfeeds.
- Before loading paper, straighten any curling in the paper.
- When adding paper, remove any paper remaining in the bypass tray, combine it with the paper to be added, and reload as a single stack. If paper is added without removing the remaining paper, a misfeed may result.

### Inserting paper

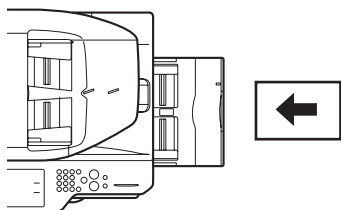

Place paper that is A5 (7-1/4" x 10-1/2") or smaller in the horizontal orientation.

### Inserting tab paper

To print on tab paper, load tab paper in the bypass tray with the print side face down.

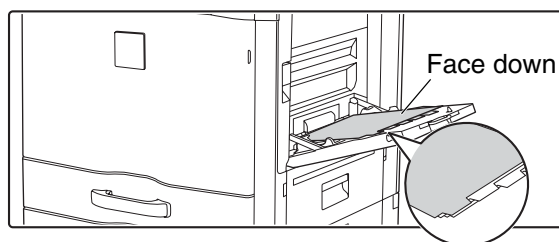

- Use only tab paper that is made of paper. Tab paper made of a material other than paper (film, etc.) cannot be used.
- **To print on the tabs of tab paper...**  
In copy mode, use "Tab Copy" in the special modes. In print mode, use the tab print function.

### Inserting transparency film

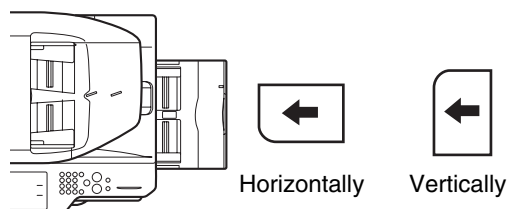

- Use SHARP-recommended transparency film. When inserting transparency film in the bypass tray, the rounded corner should be at the front left when the film is oriented horizontally, or at the far left when the film is oriented vertically.
- When loading multiple sheets of transparency film in the bypass tray, be sure to fan the sheets several times before loading.
- When printing on transparency film, be sure to remove each sheet as it exits the machine. Allowing sheets to stack in the output tray may result in curling.

## Loading envelopes

When inserting envelopes in the bypass tray, place them aligned to the left side in the orientation shown below. Only the front side of envelopes can be printed on. Be sure to place the front side face down.

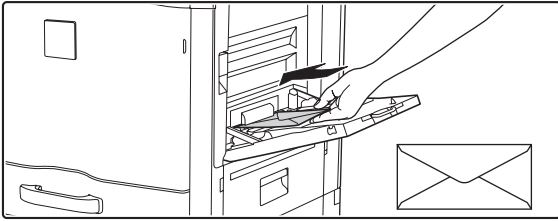

## Important points when using envelopes

- Do not print on both sides of an envelope. This may result in misfeeds or poor print quality.
- Restrictions apply to some types of envelopes. For more information, consult a qualified service technician.
- Some operating environments may cause creasing, smudging, misfeeds, poor toner fusing, or machine failure.
- Do not use the following envelopes:  
 Envelopes with metal clasps, plastic hooks, or ribbon hooks; envelopes closed with string, envelopes with windows or backing, envelopes with an uneven front surface due to embossing, double-layer envelopes, envelopes with an adhesive for sealing, hand-made envelopes, envelopes with air inside, envelopes with creases or fold marks, torn or damaged envelopes
- Envelopes with an incorrectly aligned corner gluing position on the back cannot be used as creasing may result.
- Print quality is not guaranteed in the area 10 mm (13/32") around the edges of the envelope.
- Print quality is not guaranteed on parts of envelopes where there is a large step-like change of thickness, such as on four-layer parts or parts less than three layers.
- Print quality is not guaranteed on envelopes having peel off flaps for sealing the envelopes.

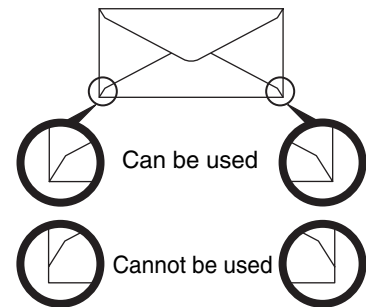

# ORIGINALS

This section explains how to place originals in the automatic document feeder and on the document glass.

## PLACING THE ORIGINAL

### PLACING ORIGINALS IN THE AUTOMATIC DOCUMENT FEEDER

This section explains how to place originals in the automatic document feeder.

#### Allowed original sizes

Minimum original size	Maximum original size
<p><b>Standard sizes</b> (Minimum size that can be automatically detected) A5: 148 mm (height) x 210 mm (width) 5-1/2" (height) x 8-1/2" (width)</p> <p><b>Non-standard sizes</b> (Minimum size that can be specified manually) 131 mm (height) x 140 mm (width) 5-1/8" (height) x 5-1/2" (width)</p>	<p><b>Standard sizes</b> (Maximum size that can be automatically detected) A3: 297 mm (height) x 420 mm (width) 12" x 18" size paper (A3W) cannot be used. 11" (height) x 17" (width)</p> <p><b>Non-standard sizes</b> (Maximum size that can be specified manually) Copy mode: 297 mm (height) x 432 mm (width) 11-5/8" (height) x 17" (width) Image send mode: 297 mm (height) x 1000 mm (width) 11" (height) x 39-3/8" (width)</p>

When the original is a non-standard size, see the appropriate explanation below for the mode you are using.

- ☞ 2. COPIER "[SPECIFYING THE ORIGINAL SIZE](#)" (page 2-29)
- ☞ 4. FACSIMILE "[IMAGE SETTINGS](#)" (page 4-46)
- ☞ 5. SCANNER / INTERNET FAX "[IMAGE SETTINGS](#)" (page 5-53)

#### Allowed original weights

<p>1-sided copying: 35 g/m<sup>2</sup> to 128 g/m<sup>2</sup> (9 lbs. to 34 lbs.) 2-sided copying: 50 g/m<sup>2</sup> to 105 g/m<sup>2</sup> (15 lbs. to 28 lbs.)</p>
---

To scan originals from 35 g/m<sup>2</sup> to 49 g/m<sup>2</sup> (9 lbs. to 14 lbs.), use "Slow Scan Mode" in the special modes. Scanning without using "Slow Scan Mode" may result in original misfeeds.

When "Slow Scan Mode" is selected, automatic 2-sided scanning is not possible.

1

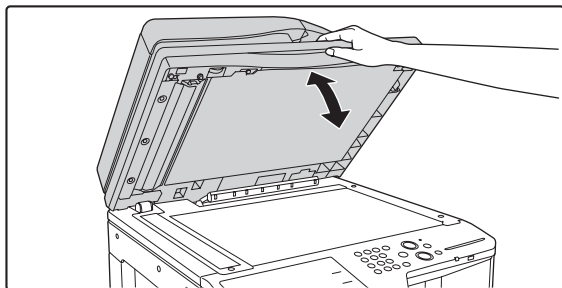

### Make sure an original does not remain on the document glass.

Open the automatic document feeder, make sure that an original is not on the document glass, and then gently close the automatic document feeder.

2

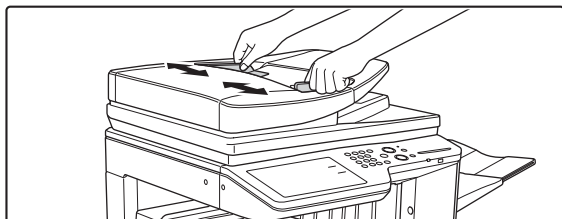

### Adjust the original guides to the size of the originals.

3

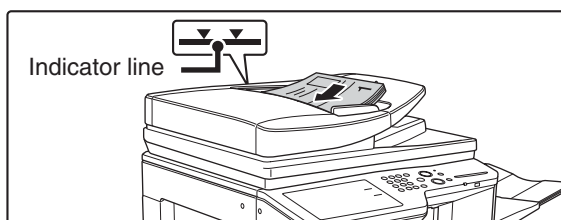

### Place the original.

Make sure the edges of the originals are even. Insert the originals face up all the way into the document feeder tray.

Insert a number of originals that does not exceed the indicator line on the document feeder tray.

Up to 100 sheets can be inserted.

Be sure to remove originals that have been finished scanning from the original exit tray.



- Originals of different sizes can be placed together in the automatic document feeder. In this case, select "Mixed Size Original" in the special modes of the mode you are using.
- Before inserting originals into the document feeder tray, be sure to remove any staples or paper clips.
- If originals have damp spots due to correction fluid, ink or pasteup glue, wait until the originals are dry before making copies. Otherwise the interior of the document feeder or the document glass may be soiled.
- Do not use the following originals. Incorrect original size detection, original misfeeds, and smudges may result. Transparency film, tracing paper, carbon paper, thermal paper or originals printed with thermal transfer ink ribbon should not be fed through the document feeder. Originals to be fed through the feeder should not be damaged, crumpled, folded, loosely pasted together, or have cut-out holes. Originals with multiple punched holes other than two-hole or three-hole punched paper may not feed correctly.
- When using originals with two or three holes, place them so that the punched edge is at a position away from the feed slot of the document feeder tray.

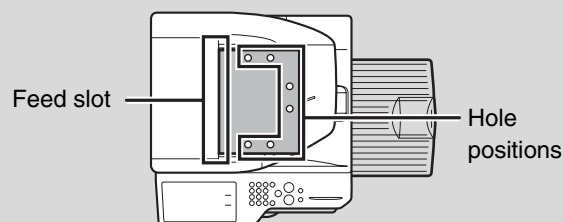



# PLACING THE ORIGINAL ON THE DOCUMENT GLASS

This section explains how to place the original on the document glass.

## Allowed original sizes

Maximum original size
<b>Standard sizes</b> A3: 297 mm (height) x 420 mm (width) 11" (height) x 17" (width)
<b>Non-standard sizes</b> 297 mm (height) x 432 mm (width) 11-5/8" (height) x 17" (width)

When the original is a non-standard size, see the appropriate explanation below for the mode you are using.

- ☞ 2. COPIER "SPECIFYING THE ORIGINAL SIZE" (page 2-29)
- ☞ 4. FACSIMILE "IMAGE SETTINGS" (page 4-46)
- ☞ 5. SCANNER / INTERNET FAX "IMAGE SETTINGS" (page 5-53)

1

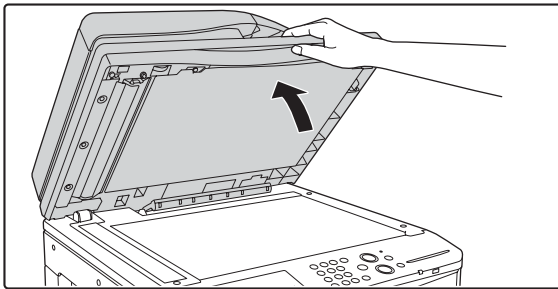

Open the automatic document feeder.

2

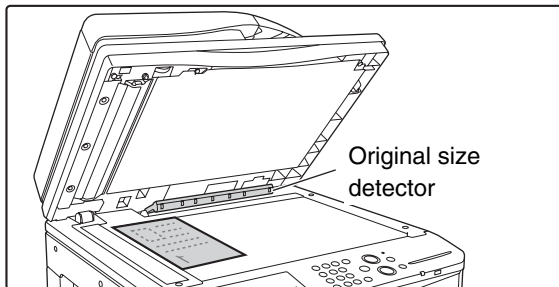

## Place the original.

Place the original face down in the far left corner of the document glass.

Document glass scale

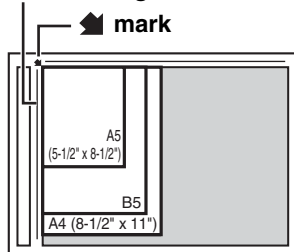

Document glass scale

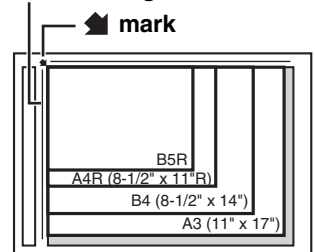

The original should always be placed in the far left corner, regardless of its size.

Align the top left corner of the original with the tip of the  mark.



Do not place any objects under the original size detector.

Closing the automatic document feeder with an object underneath may damage the original size detector and prevent correct detection of the original size.



If you are placing a small non-standard size original on the document glass, it is convenient to place a blank sheet of A4 or B5 (8-1/2" x 11" or 5-1/2" x 8-1/2") paper on top of the original to facilitate detection of the original size.

3

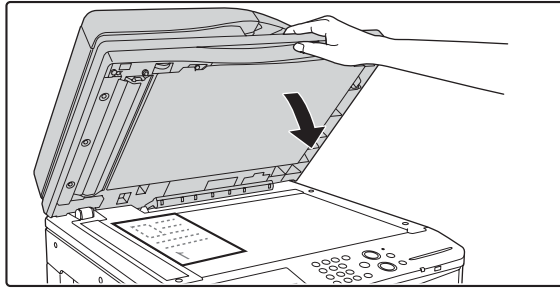

### Close the automatic document feeder.

After placing the original, be sure to close the automatic document feeder. If left open, parts outside of the original will be copied black, causing excessive use of toner.

## Placing a thick book

When scanning a thick book or other thick original, follow the steps below to press the book down.

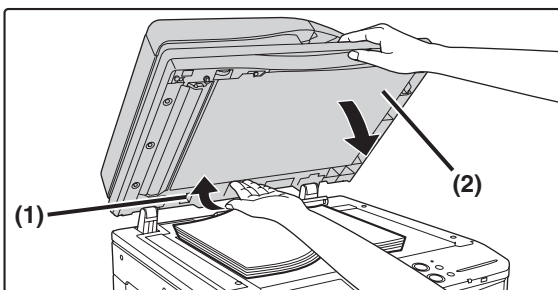

### (1) Push up the far side of the automatic document feeder.

The hinges supporting the automatic document feeder will release and the rear side of the automatic document feeder will rise.

### (2) Slowly close the automatic document feeder.

### Caution

- Close the automatic document feeder slowly. Abruptly closing the automatic document feeder may damage it.
- Take care that your fingers are not pinched when closing the automatic document feeder.



The automatic document feeder cannot be closed correctly in this state. To return the automatic document feeder to its normal state, open it completely and then close it.

# PERIPHERAL DEVICES

This section describes the peripheral devices that can be used with the machine and explains how to use the finisher, as well as Sharp OSA (application communication module and external account module).

## PERIPHERAL DEVICES

Peripheral devices can be installed on the machine to increase its range of functionality.

The peripheral devices are generally optional, however, some models include certain peripheral devices as standard equipment.

(As of Nov, 2012)

Product name	Product number	Description
Stand/1x500 sheet paper drawer	MX-DE12	Additional tray. A maximum 500 sheets of paper can be loaded in each tray.
Stand/2x500 sheet paper drawer	MX-DE13	
Stand/3x500 sheet paper drawer	MX-DE14	
Stand/500&2000 sheet paper drawer	MX-DE20	Additional paper trays. Tray 2 can hold a maximum of 500 sheets of paper, tray 3 can hold a maximum of 1150 sheets, and tray 4 can hold a maximum of 850 sheets.
Exit tray unit (Right tray)	MX-TR13 N MX-TR12*	This can be added to the right side of the machine.
Long paper feeding tray	MX-LT10	Long paper with a size up to 1200 mm can be loaded.
Finisher	MX-FN17	Output device that enables the use of the staple function and offset function.
Punch module	MX-PN11A MX-PN11B MX-PN11C MX-PN11D	Punches holes in copies and other output. Requires a finisher.
Barcode font kit	MX-PF10	Adds barcode fonts to the machine.
PS3 expansion kit	MX-PK11	Enables the machine to be used as a Postscript compatible printer.
XPS expansion kit	MX-PUX1	The machine can be used as an XPS compatible printer. For details, consult your dealer.
Internet fax expansion kit	MX-FWX1	Enables Internet Fax.
Facsimile expansion kit	MX-FX11	Adds a fax function.
Application integration module	MX-AMX1	The application integration module can be combined with the network scanner function to append a metadata file to a scanned image file.
Application communication module	MX-AMX2	This allows the machine to be linked over a network to an external software application.
External account module	MX-AMX3	This is required to use an external account application on the machine.
Productivity Kit	MX-EB16*	The range of available functions can be expanded by installing this kit.

Product name	Product number	Description
Keyboard	MX-KB14 N	This is a keyboard that is integrated with the machine. When not in use, it can be stored under the operation panel.
Wireless LAN USB adapter	MX-EB13	Adds the wireless LAN function to the machine.
Sharpdesk 1 licence kit	MX-USX1	This software enables integrated management of documents and computer files.
Sharpdesk 5 licence kit	MX-USX5	
Sharpdesk 10 licence kit	MX-US10	
Sharpdesk 50 licence kit	MX-US50	
Sharpdesk 100 licence kit	MX-USA0	
Sharp OSA Network Scanner Tool 1 Licence Kit	MX-UN01A	This is an application that streamlines scan operations, such as the automatic sorting of scanned data into folders.
Sharp OSA Network Scanner Tool 5 Licence Kit	MX-UN05A	
Sharp OSA Network Scanner Tool 10 Licence Kit	MX-UN10A	
Sharp OSA Network Scanner Tool 50 Licence Kit	MX-UN50A	
Sharp OSA Network Scanner Tool 100 Licence Kit	MX-UN1HA	
Stamp unit	AR-SU1	This stamps each original page after it is scanned in image send mode.

\* MX-2314N only



Some options may not be available in some countries and regions.

# FINISHER

The finisher is equipped with the offset function, which offsets each set of output from the previous set.

In addition, each set of sorted output can be stapled.

An optional hole punching unit can also be installed to punch holes in output.

## PART NAMES

The following parts can be accessed when the finisher is open.

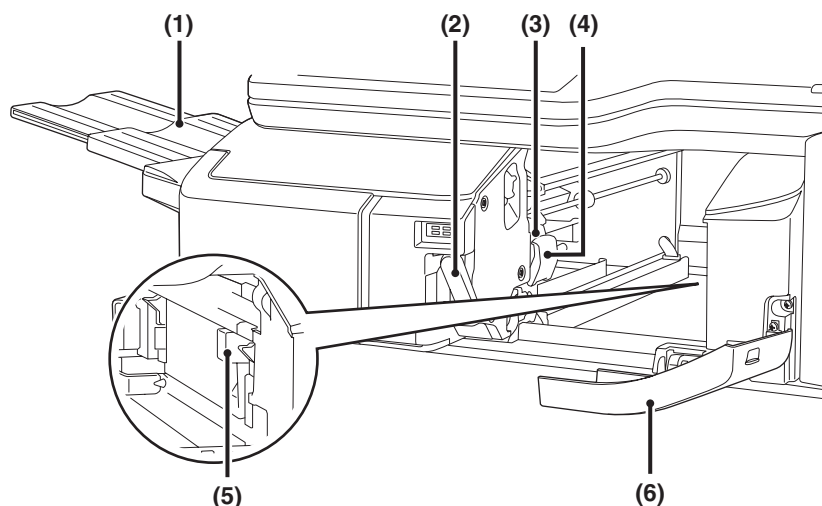

**(1) Output tray**

Stapled and offset output is delivered to this tray. The tray is slidable. Extend the tray for large output (A3W, A3, A4R, B4, B5R, 12" x 18", 11" x 17", 8-1/2" x 14", 8-1/2" x 13", 8-1/2" x 13-1/2", 8-1/2" x 13-2/5", 8-1/2" x 11"R, 7-1/4" x 10-1/2"R, 8K and 16KR sizes).

**(2) Lever**

Use this to move the finisher in order to remove a paper misfeed, replace staples, or remove a staple jam.

**(3) Staple case**

This holds the staple cartridge. Pull the case out to replace the staple cartridge, remove a staple jam, or remove the punch scrap case.

**(4) Staple case release lever**

Use this to remove the staple case.

**(5) Punch waste box (when a punch module is installed)**

This holds punch waste.

**(6) Front cover**

Open this cover to remove a paper misfeed, replace staples, remove a staple jam, or remove the punch scrap case.



Use caution when you turn on the power and when printing is taking place, as the tray may move up and down.

## SUPPLIES

The finisher requires the following staple cartridge:

Staple cartridge  
(approx. 5000 staples per cartridge x 3 cartridges)  
MX-SCX1

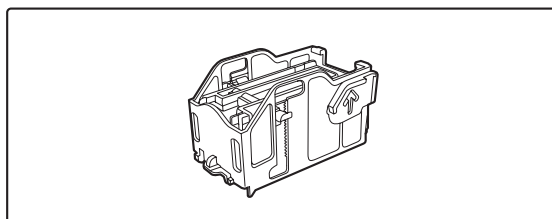

# FINISHER MAINTENANCE

When the staple cartridge runs out of staples, a message will appear in the operation panel. Follow the procedure below to replace the staple cartridge.

## Replacing the staple cartridge

1



**Open the cover.**

2

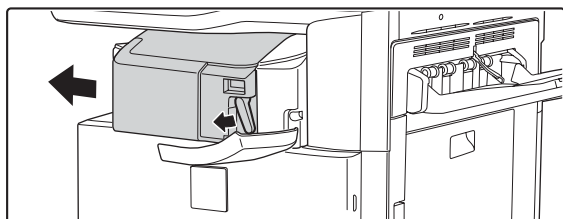

**While pressing the lever over to the left, slide the finisher to the left until it stops.**

Gently slide the finisher until it stops.

3

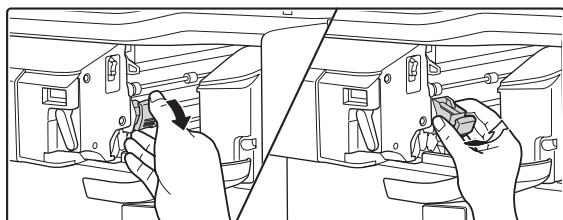

**Lower the staple case release lever and remove the staple case.**

Pull the staple case out to the right.

4

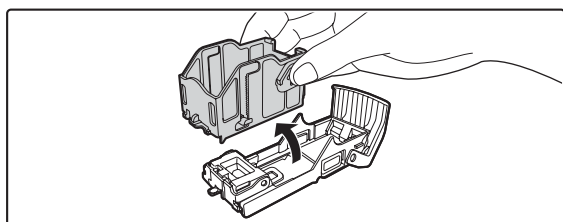

**Remove the empty staple cartridge from the staple case.**

5

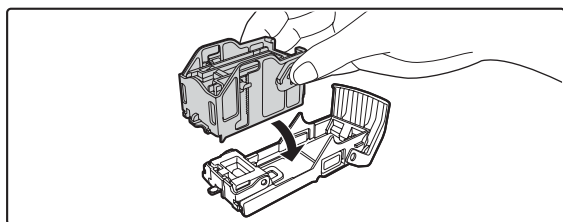

**Insert a new staple cartridge into the staple case as shown.**

Push the staple cartridge in until it clicks into place.

6

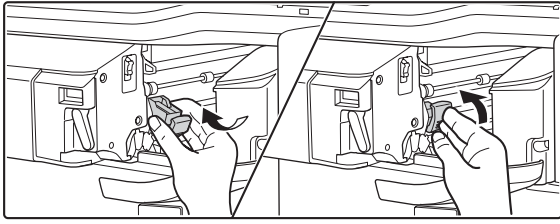

**Replace the staple case.**

Push the staple case in until it clicks into place.

7

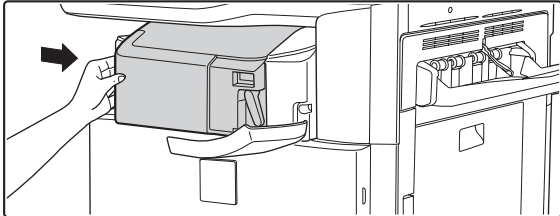

**Slide the finisher back to the right.**

Gently slide the finisher back to the right until it locks into its original position.

8

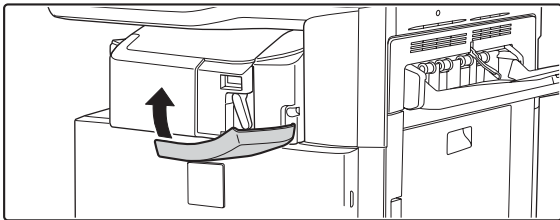

**Close the cover.**



Make a test print or copy in staple sort mode to verify that stapling takes place correctly.

# PUNCH MODULE

A punch module can be installed to punch holes in output. To install a punch module, a finisher is required.

## DISCARDING PUNCH WASTE

Punch waste from punched holes is collected in the punch waste box.

Follow the steps below to discard the punch waste.

### Finisher

1

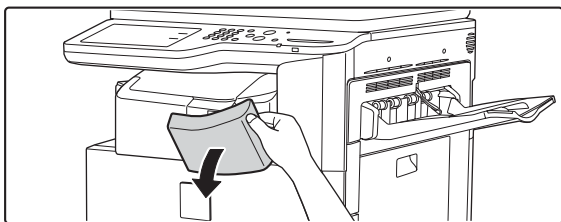

Open the cover.

2

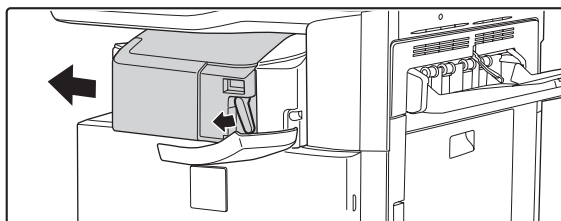

While pressing the lever over to the left, slide the finisher to the left until it stops.

Gently slide the finisher until it stops.

3

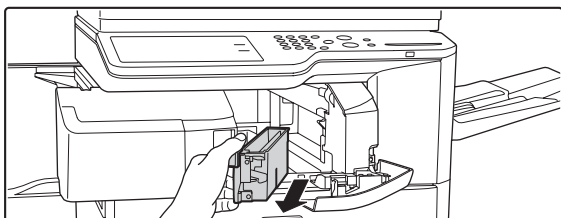

Grasp the punch waste box handle, gently pull out the box, and discard the punch waste.

Discard the punch waste in a plastic bag or other container, taking care not to let the waste scatter.

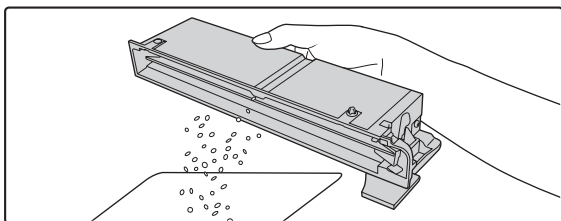

4

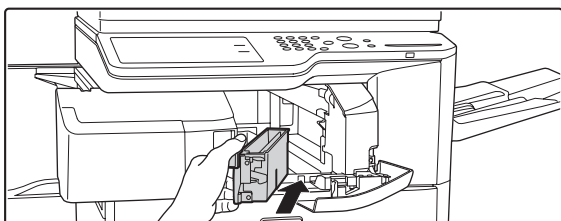

Gently push the box back in.



5

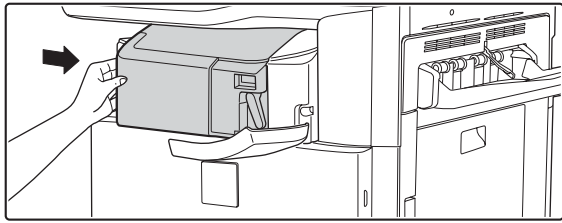

**Slide the finisher back to the right.**

Gently slide the finisher back to the right until it locks into its original position.

6

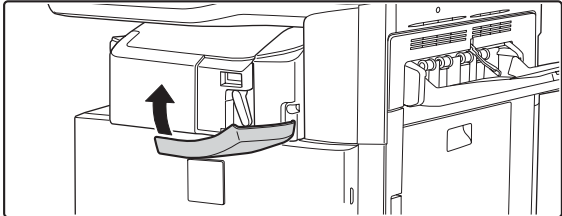

**Close the cover.**

# SHARP OSA

(On the MX-2314N, the productivity kit is required.)

Sharp OSA (Open Systems Architecture) is an architecture that enables external applications to be directly connected to a digital multifunction machine over a network.

When a digital multifunction machine that supports Sharp OSA is used, the operation panel controls and functions of the machine such as scan send can be linked to an external application.

There are two types of external applications: "standard application" and "external account application". An "external account application" is used for centralized account management of a multifunction machine on a network. A "standard application" refers to all other applications.

## APPLICATION COMMUNICATION MODULE (MX-AMX2)

The application communication module is required to use a "standard application" on the machine.

When a previously registered standard application is selected in the Web pages of the machine, the machine retrieves the operation screen from the registered URL. Control of the operation screen is performed by the standard application, and Scan to FTP, Scan to Network Folder, and HTTPS transmission can be executed.

### Standard application setup

To enable a general application in the Web pages of the machine, click [Application Settings] in the administrator menu frame, and then [External Applications Settings] and [Standard Applications]. Configure settings for the standard application in the screen that appears.

### Selecting a standard application

The procedure for selecting a general application that has been enabled in the Web pages of the machine is explained below.

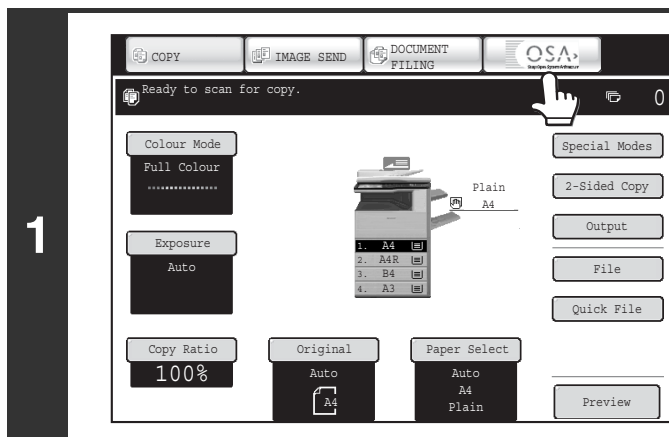

### Touch the [Sharp OSA] key in the mode select keys.

If no standard applications have been stored in the Web pages, the key cannot be touched.

2

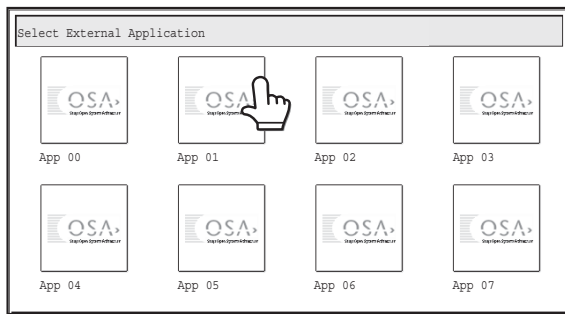

### Select the standard application.

If two or more standard applications have been stored in the Web pages, the screen to select the standard application will appear. Touch the standard application that you wish to use. If only one standard application has been stored in the Web pages, connection to the standard application will begin.

3

### The machine connects to the standard application.

The message "Connecting to the external application." appears while the machine communicates with the standard application.



The mode select key cannot be used during scanning.

## EXTERNAL ACCOUNT MODULE (MX-AMX3)

The external account module is required to use a "external account application" on the machine.

An external account application can be used in "external authentication mode" or "external count mode". When external authentication mode is used, the login screen is retrieved from the application when the machine is started. When a job ends, a job notification screen is sent to the application to enable counts to be kept for each authenticated user.

When "external count mode" is used, the login screen is not displayed when the machine is started. Only a job result notification is sent to the application. User authentication by the external account application cannot be used, however, the external account application can be used in combination with the internal account function.

### External account application setup

To enable an external account application in the Web pages of the machine, click [Application Settings] in the administrator menu frame, and then [External Applications Settings] and [External Accounting Application Settings]. Configure settings for the external account application in the screen that appears. The setting change will take effect after the machine is restarted. To restart the machine, see "[TURNING THE POWER ON AND OFF](#)" (page 1-15).

### Operation in external account mode

The two modes for using an external account application operate as explained below.

#### External authentication mode

When the [Enable Authentication by External Server] checkbox is selected in "External Account Setting" of "Sharp OSA Settings" in the system settings (administrator), the machine enters external authentication mode. When the machine is powered on in external authentication mode, the machine accesses the external account application and displays the login screen. The login screen also appears when the [Call] key is touched to run a job in the job status complete screen. (The login screen does not appear if the user has already logged in by the normal method.)

The [JOB STATUS] key (↔) can be touched while the login screen appears to show the job status screen. To return to the previous state, press the mode select key.



- The user control function of the machine cannot be used in external authentication mode. However, "User Registration", "User Count Display", "User Count Reset", "User Information Print", and "The Number of User Name Displayed Setting" can be used.
- The mode select key cannot be used while the login screen appears.

## If login fails

If the login screen fails to appear or the application does not operate correctly, the machine may also stop operating correctly. In this event, it is recommended that you quit external account mode from the Web pages of the machine. For more information, see [Help] in the Web pages.

If it is necessary to forcibly terminate external account mode using the operation panel of the machine, follow the steps below.

Touch the [SYSTEM SETTINGS] key (  ) and change "External Account Setting" in the system settings (administrator). The setting change will take effect after the machine is restarted. To restart the machine, see "[TURNING THE POWER ON AND OFF](#)" (page 1-15).

## External count mode

When only the [External Account Control] setting is enabled in "External Account Setting" of "Sharp OSA Settings" in the system settings (administrator), the machine enters external count mode.

Unlike external authentication mode, when the machine is started in "external count mode", the login screen of the external account application is not displayed. Only the job result is sent to the external account application. External count mode can be used together with the user control function of the machine. (External count mode can also be used when the user control function is disabled.)

# MAINTENANCE

This section explains how to clean the machine and replace the toner cartridges and the waste toner box.

## REGULAR MAINTENANCE

To ensure that the machine continues to provide top quality performance, periodically clean the machine.

### Warning

**Do not use a flammable spray to clean the machine. If gas from the spray comes in contact with hot electrical components or the fusing unit inside the machine, fire or electrical shock may result.**

-  Do not use thinner, benzene, or similar volatile cleaning agents to clean the machine. These may degrade or discolour the housing.
- Use a soft cloth to gently wipe off dirt from the area on the operation panel with a mirror-like finish (shown at right). If you use a stiff cloth or rub hard, the surface may be damaged.

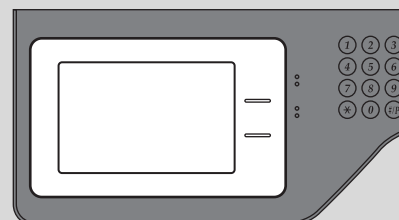

The area with a mirror-like finish is the area that is .

## CLEANING THE DOCUMENT GLASS AND AUTOMATIC DOCUMENT FEEDER

If the document glass or document backplate sheet becomes dirty, the dirt will appear as dirty spots, coloured lines, or white lines in the scanned image. Always keep these parts clean.

Wipe the parts with a clean, soft cloth.

If necessary, moisten the cloth with water or a small amount of neutral detergent. After wiping with the moistened cloth, wipe the parts dry with a clean dry cloth.

### Document glass

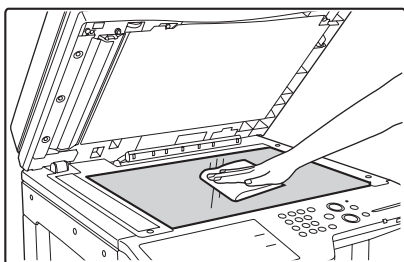

### Document backplate sheet

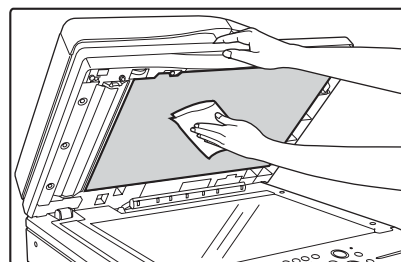

### Scanning area

If coloured lines or white lines appear in images scanned using the automatic document feeder, clean the scanning area (the thin long glass next to the document glass).

To clean this area, use the glass cleaner that is stored in the automatic document feeder. After using the glass cleaner, be sure to return it to its storage position.

### Examples of lines in the image

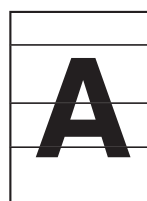

Black lines



White lines

1

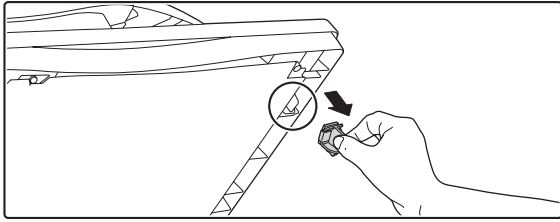

Open the automatic document feeder and remove the glass cleaner.

2

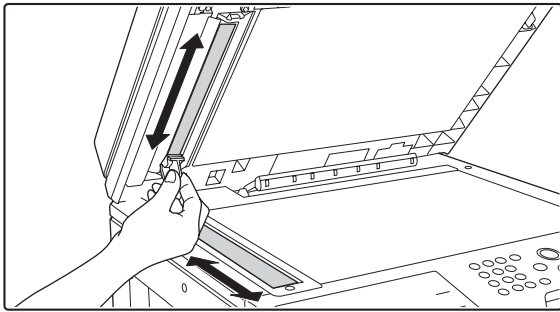

Clean the document scanning area on the document glass with the glass cleaner.

3

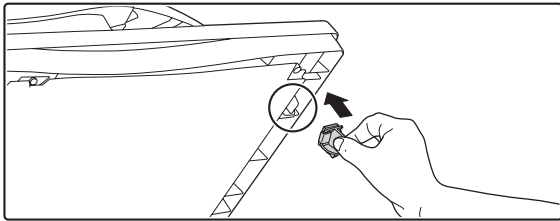

Replace the glass cleaner.

# CLEANING THE MAIN CHARGER OF THE PHOTOCONDUCTIVE DRUM

If black lines or coloured lines appear even after you have cleaned the document glass and automatic document feeder, use the charger cleaner to clean the main charger that charges the drum.

1

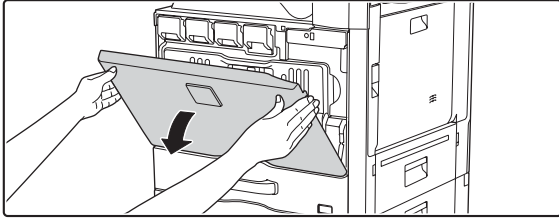

**Open the front cover.**

2

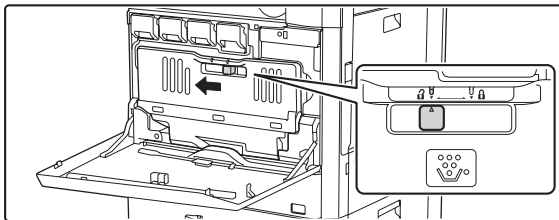

**Release the waste toner box.**

Move the lock of the waste toner box to the release position.

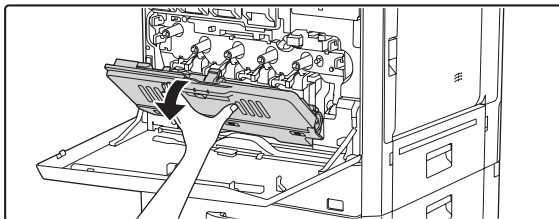

Release the lock of the waste toner box and let it fall forward as far as it will go as shown in the figure.

3

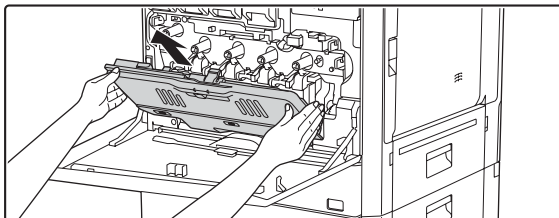

**Remove the waste toner box.**

Hold the box by both hands and lift it up slowly.

If the waste toner box falls too far forward, it will not be possible to remove it. (Remove the box when it is at an angle of about 30 degrees.)

4

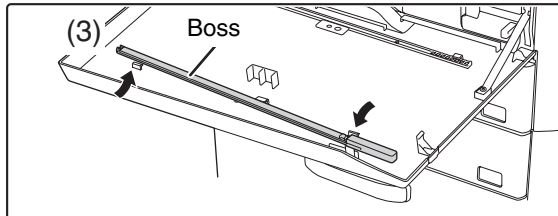
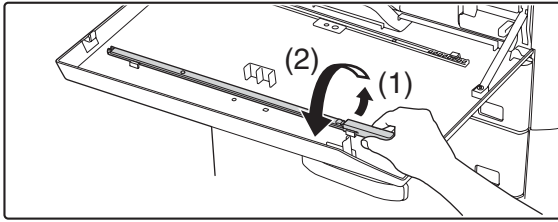

### Remove the charger cleaner

The charger cleaner is attached to the front cover of the machine.

- (1) Unfasten it from the claw by pressing the right side of the charger cleaner.
- (2) Place it in the front spread across the top of the claw.
- (3) Unfasten the charger cleaner rotating around the boss from the claw on the left side.

5

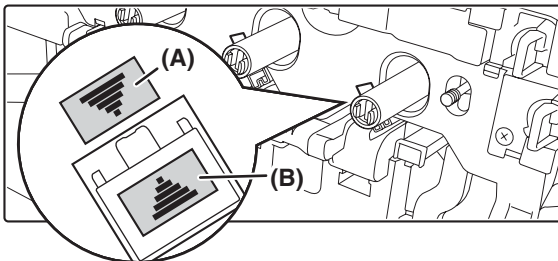
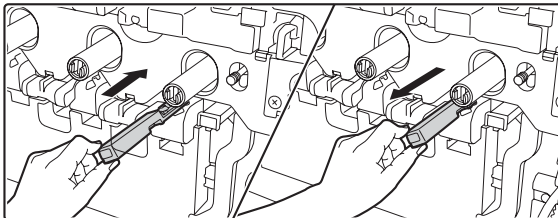

### Clean the main charger.

- (1) Gently push the charger cleaner all the way in.
- (2) Gently pull the charger cleaner out.

Insert so that the cleaning location label (A) and the charger cleaner label (B) are oriented as shown.

6

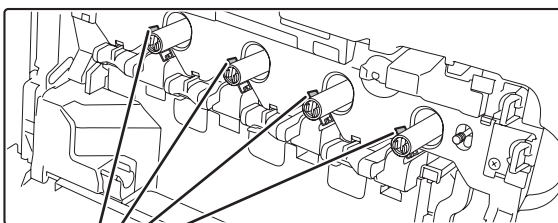

Main charger

### Repeat step 4 with each of the other main chargers.

There are a total of 4 places to be cleaned in the machine as shown.



7

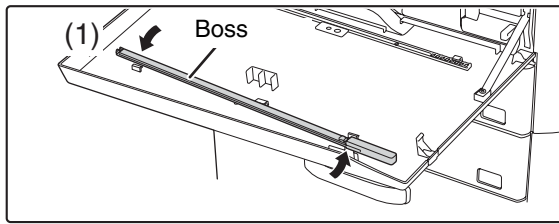

**Replace the charger cleaner in its original position.**

(1) Rotate the charger cleaner after putting it on the boss and hook its edge (the side that does not have a handle) to the claw on the left side.

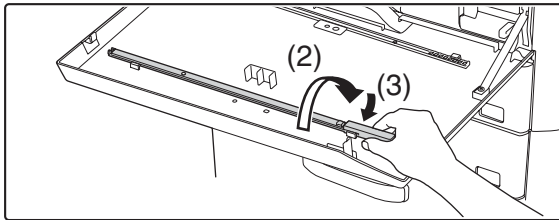

(2) Place the right-hand side of the charger cleaner on the inner side, spread across the top of the claw.

(3) Hook the charger cleaner to the claw.

8

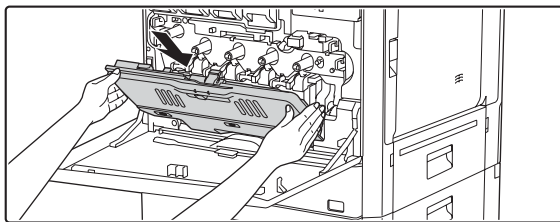

**Mount the waste toner box.**

Insert it in a direction slanting from the top towards the bottom. (A direction opposite to that at the time of mounting it.)

9

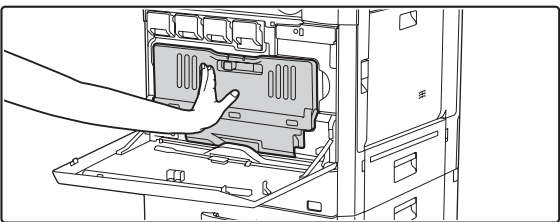

**Push the waste toner box into the machine.**

Push the waste toner box firmly in until it clicks into place.

10

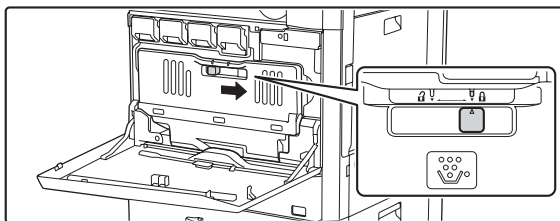

**Lock the waste toner box.**

Move the lock of the waste toner box to the lock position.

11

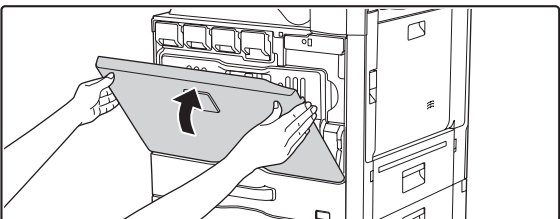

**Close the front cover.**



- If this does not solve the problem, pull the knob out and push it back in 3 more times.
- When pulling and pushing the knob to clean the charger, pull and push the knob slowly from one end to the other.

# CLEANING THE PT CHARGER OF THE PRIMARY TRANSFER BELT

If black lines or coloured lines appear even after you have cleaned the document glass, automatic document feeder and the main charger, use the PT charger cleaner to clean the PT charger.

1

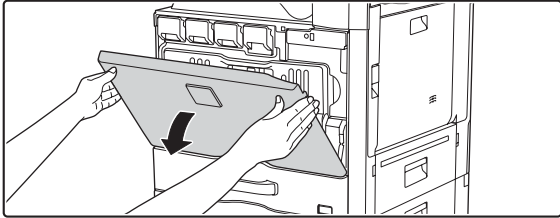

**Open the front cover.**

2

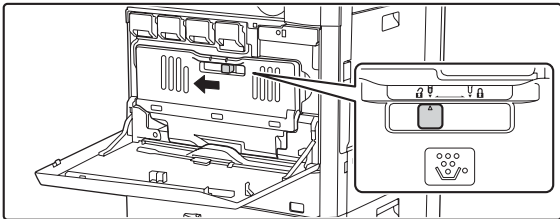

**Release the lock of the waste toner box.**

Move the lock of the waste toner box to the release position.

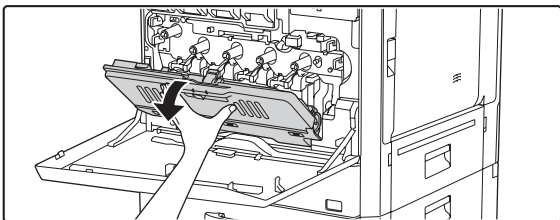

Release the lock of the waste toner box and let it fall forward as far as it will go as shown in the figure.

3

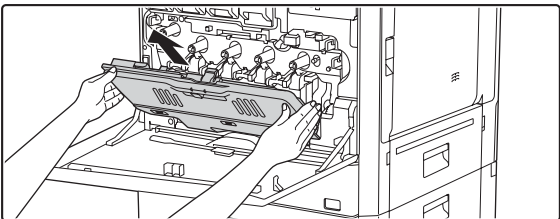

**Remove the waste toner box.**

Hold the box by both hands and lift it up slowly.

If the waste toner box falls too far forward, it will not be possible to remove it. (Remove the box when it is at an angle of about 30 degrees.)

4

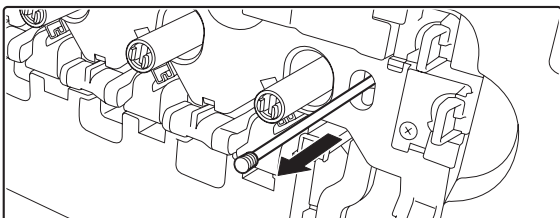

**Clean the PT charger**

(1) Slowly pull out the PT charger cleaner till a point where it offers resistance.

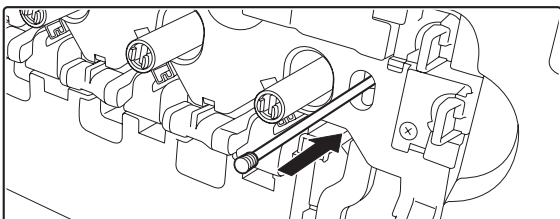

(2) Slowly push the PT charger cleaner back till the end.

(3) Repeat the steps (1) and (2) three times.

5

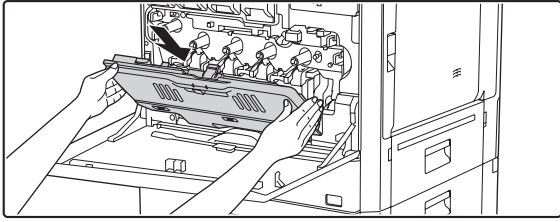
**Mount the waste toner box.**

Insert it in a direction slanting from the top towards the bottom.  
(A direction opposite to that at the time of mounting it.)

6

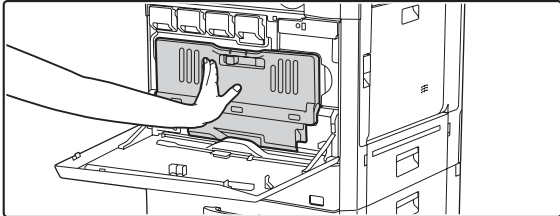
**Push the waste toner box in till the innermost point.**

Push it in until it clicks into place.

7

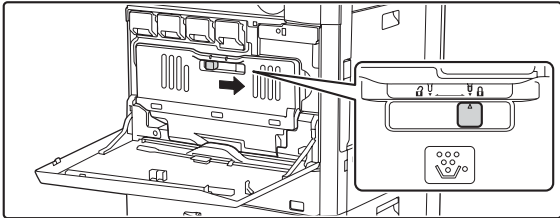
**Lock the waste toner box.**

Move the lock of the waste toner box to the lock position.

8

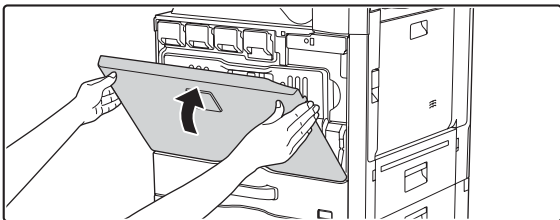
**Close the front cover.**

## CLEANING THE BYPASS FEED ROLLER

If paper misfeeds frequently occur when feeding envelopes or heavy paper through the bypass tray, wipe the surface of the feed roller with a clean soft cloth moistened with water or a neutral detergent.

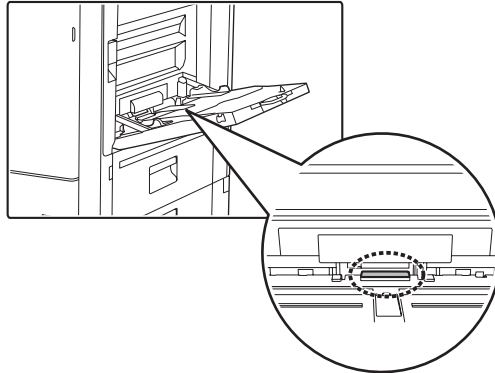

## CLEANING THE ORIGINAL FEED ROLLER

If lines or other dirt appear on the scanned original when the automatic document feeder is used, wipe the surface of the roller with a clean soft cloth moistened with water or a neutral detergent.

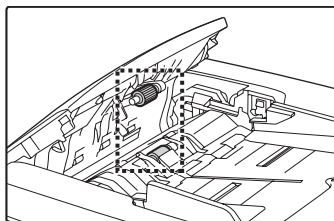

# CLEANING THE LASER UNIT

When the laser unit inside the machine becomes dirty, line patterns (coloured lines) may form in the printed image.

## Identifying lines (coloured lines) caused by a dirty laser unit

- Coloured lines always appear in the same place. (The lines are never black.)
- The coloured lines are parallel to the direction of paper feeding.
- Coloured lines appear not only on copies but also on print jobs from a computer. (The same lines appear on both copies and print jobs.)

If the above problems occur, follow the steps below to clean the laser unit.

1

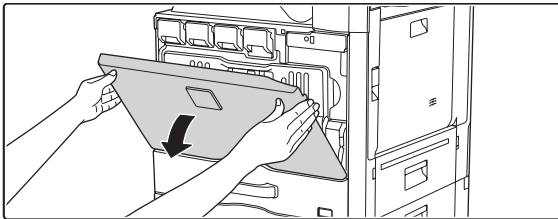

**Open the front cover.**

2

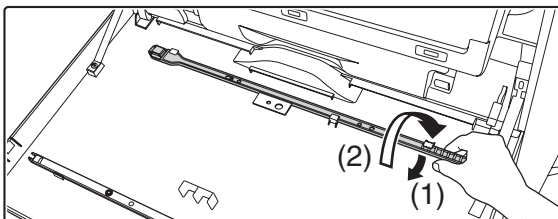

**Take out the cleaning tool for the laser unit.**

The cleaning tool is attached to the front cover.

- (1) Pull the right side of the cleaning instrument and unfasten it from the claw.
- (2) Place it in the front spread across the top of the claw.
- (3) Unfasten the cleaning instrument rotating around the boss from the claw on the left side.

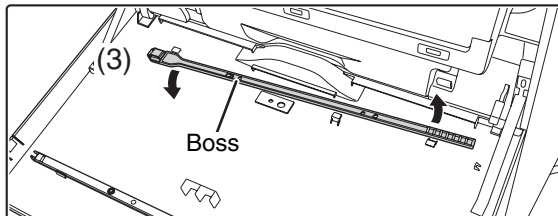

3

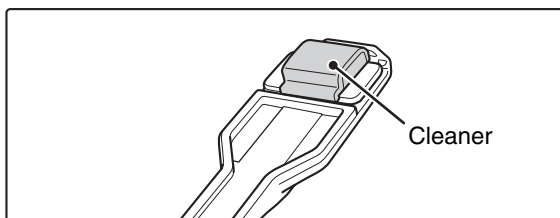

**Make sure that the cleaner at the tip of the cleaning tool is not dirty.**

If the cleaner is dirty, remove the cleaner and replace it with a clean one. For the procedure for replacing the cleaner, see steps 4 through 6. If the cleaner is not dirty, go to step 7.

4

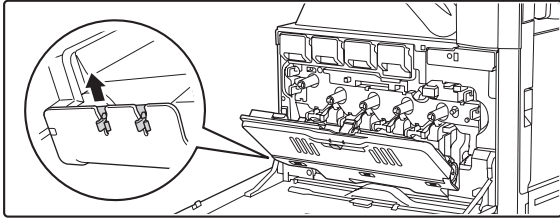

### Open the inner cover and take out a replacement cleaner.

Replacement cleaners are stored on the inner cover. Grasp the end of the cleaner and pull it out of the cover.

5

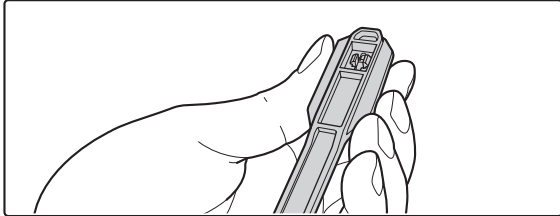

### Remove the dirty cleaner from the tip of the cleaning tool.

(1) Firmly grasp the tool close to where the cleaner is attached.

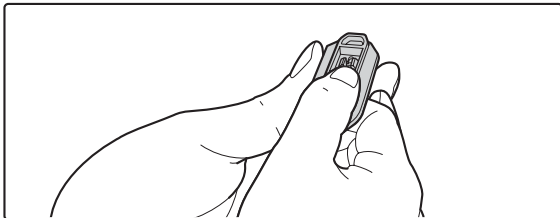

(2) Use your other hand to press down on the hook that secures the cleaner and remove the cleaner.



Put the removed cleaner back on the inner cover. After replacing the cleaner, be sure to close the inner cover.

6

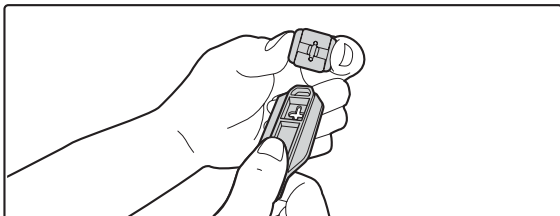

### Attach the new cleaner to the cleaning tool.

(1) Align the cleaner hook with the attachment hole in the cleaning tool.

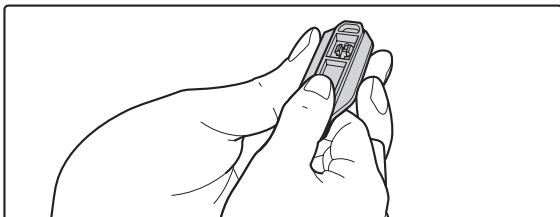

(2) Hold the cleaner firmly and push the cleaning tool in.

7

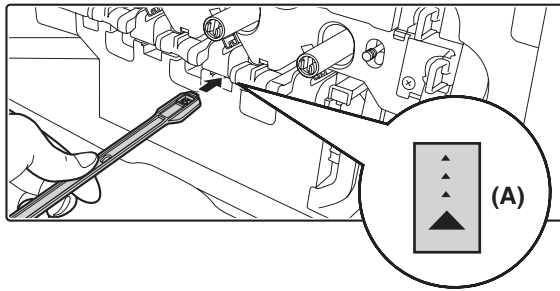

### Open the inner cover and clean the laser unit.

- (1) **Point the cleaner down and slowly insert the tool into the hole that you wish to clean.**

Be sure to point the cleaner down.

Labels similar to (A) are attached to areas that require cleaning.

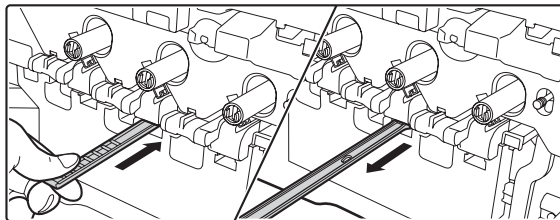

- (2) **Insert the cleaning tool all the way into the hole and then pull it back out.**

Pull the cleaning tool out until you feel the tip of the tool leave the cleaning surface of the laser unit.

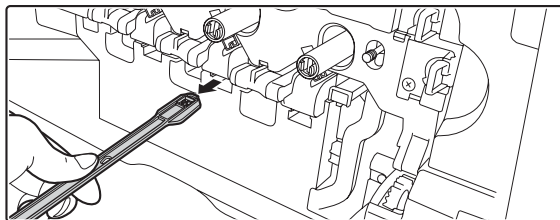

- (3) **Repeat step (2) two or three times and then remove the cleaning tool.**

8

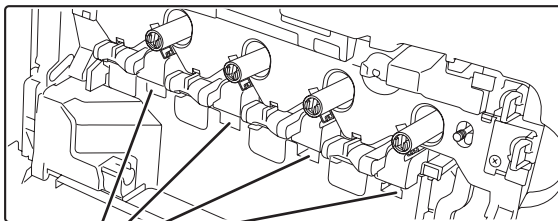

Holes to be cleaned

### Repeat step 7 to clean all holes in the laser unit (4 holes).

There are a total of 4 holes to be cleaned in the laser unit, including the hole cleaned in step 7. Clean all holes.

9

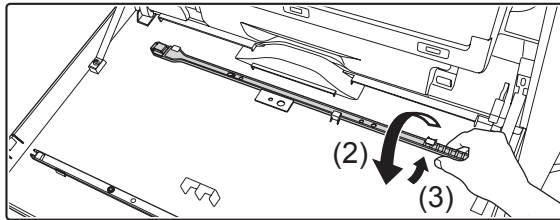
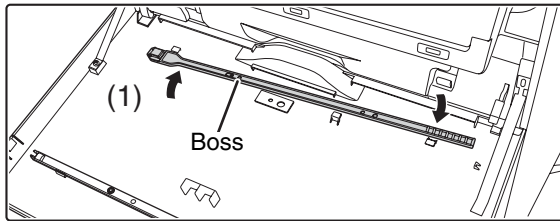
**Replace the cleaning tool.**

- (1) Rotate the cleaning instrument after putting it on the boss and hook its edge (the side where the cleaner is fixed) to the claw on the left side.
- (2) Place the right-hand side of the cleaning instrument on the front side, spread across the top of the claw.
- (3) Hook the cleaning instrument to the claw.

10

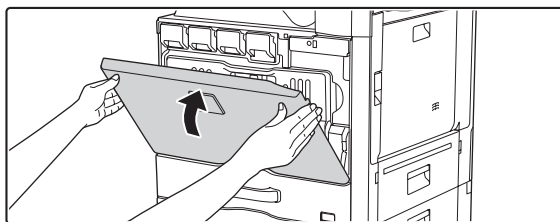
**Close the inner cover and the front cover.**



# REPLACING THE TONER CARTRIDGES

Be sure to replace the toner cartridge when the message "Change the toner cartridge." appears.

## In copy mode

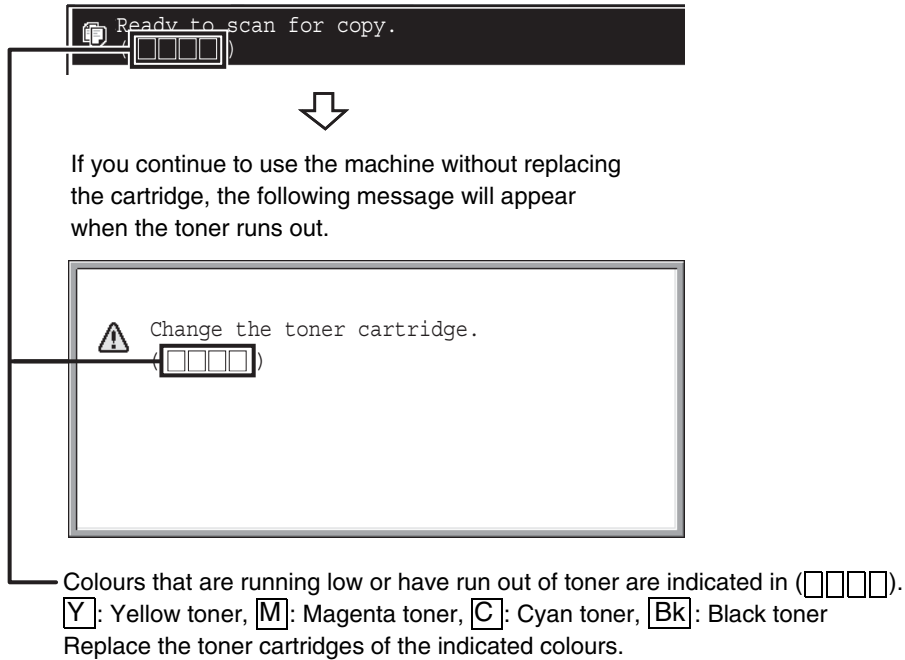

- If any one of the toner colours runs out (including black toner), colour printing will not be possible. If Y, M, or C toner runs out but Bk toner remains, black and white printing will still be possible.
- Be sure to install 4 toner cartridges (Y/M/C/Bk).

1

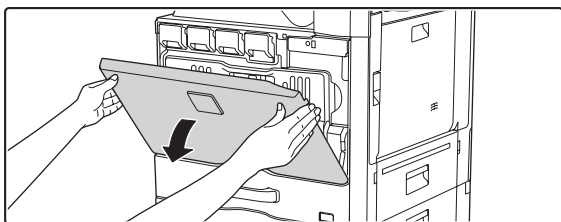

**Open the front cover.**

**Locations of colour toner cartridges**

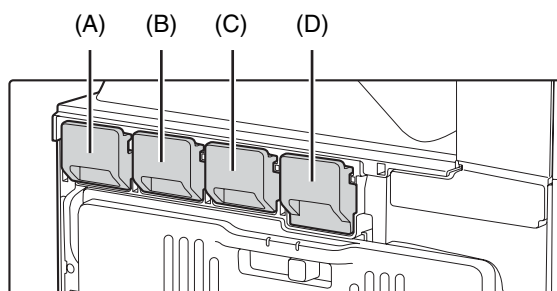

(A): Yellow (B): Magenta  
(C): Cyan (D): Black

2

**Example: Replacing the yellow toner cartridge**

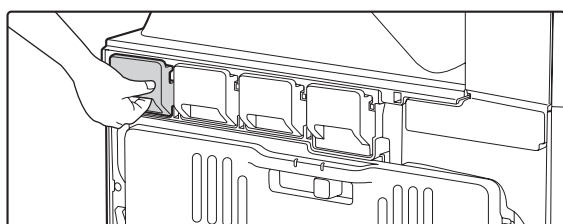

**Pull the toner cartridge toward you.**

Gently pull the toner cartridge horizontally toward you.  
If the cartridge is pulled out abruptly, toner may spill out.

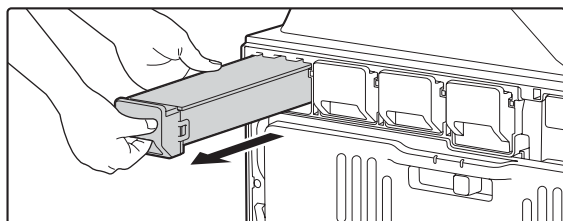

Hold the toner cartridge with both hands as shown and pull it out of the machine.

3

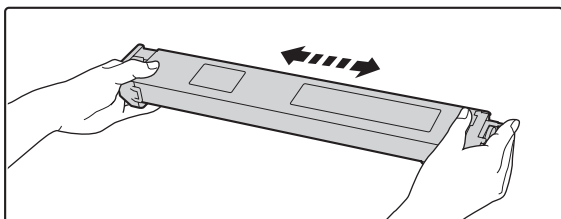

**Remove a new toner cartridge from its package and shake it horizontally five or six times.**

4

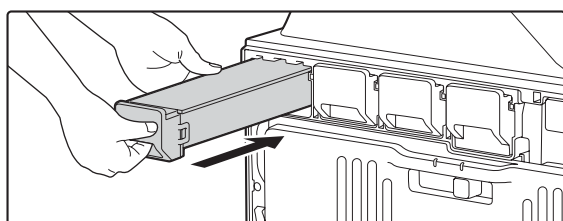

**Gently insert the new toner cartridge horizontally.**



A toner cartridge of a different colour cannot be installed. Be sure to install a toner cartridge of the same colour.

5

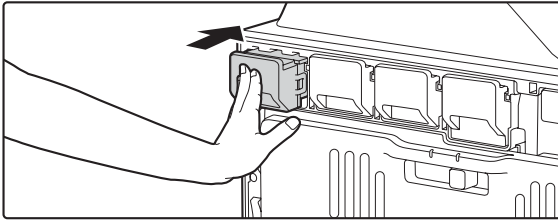

### Push the cartridge in until it locks securely in place.

Push the cartridge firmly in until it clicks into place.

6

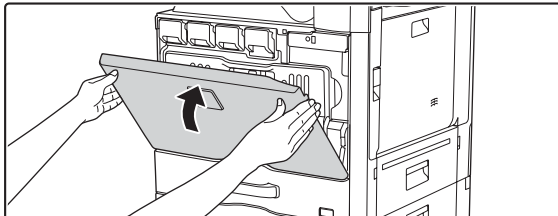

### Close the front cover.

After the toner cartridge is replaced, the machine automatically enters image adjustment mode.

### Caution

- Do not throw a toner cartridge into a fire. Toner may fly and cause burns.
- Store toner cartridges out of the reach of small children.
- If a toner cartridge is stored on end, the toner may harden and become unusable. Always store toner cartridges on their side.
- If a toner cartridge other than a SHARP-recommended toner cartridge is used, the machine may not attain full quality and performance and there is a risk of damage to the machine. Be sure to use a SHARP-recommended toner cartridge.



- Keep the used toner cartridge in a plastic bag (do not discard it). Your service technician will collect the used toner cartridge.
- To view the approximate amount of toner remaining, continually touch the [COPY] key during printing or when the machine is idle. The percentage of toner remaining will appear in the display while the key is touched. When the percentage falls to "25-0%", obtain a new toner cartridge and keep it ready for replacement.
- Depending on your conditions of use, the colour may become faint or the image blurred.

# REPLACING THE WASTE TONER BOX

The waste toner box collects excess toner that is produced during printing. When the waste toner box becomes full, "Replace used toner container." will appear. Follow the procedure below to replace the waste toner box.

1



**Open the front cover.**

2

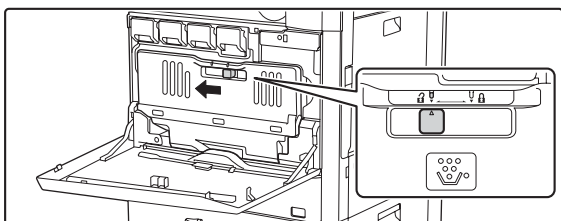

**Release the used waste toner box.**

Move the lock of the waste toner box to the release position.

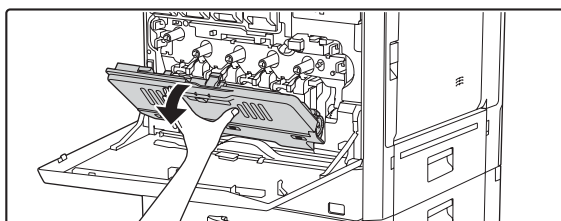

Release the lock of the waste toner box and let it fall forward as far as it will go as shown in the figure.

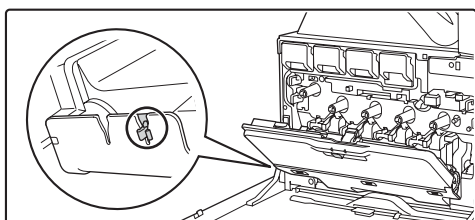

Keep the replacement cleaner that has not been used.  
Store it on the left of the new waste toner box.

3

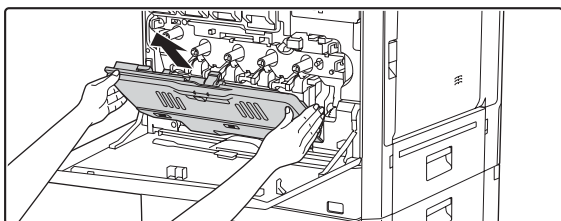

**Remove the waste toner box.**

Hold the box by both hands and lift it up slowly.  
If the waste toner box falls too far forward, it will not be possible to remove it. (Remove the box when it is at an angle of about 30 degrees.)

4

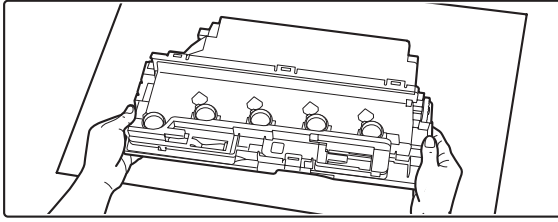

### Place the box on a flat surface.

Place a sheet of newspaper on the surface before placing the box.



- Do not point the holes down as used toner will spill out.
- Do not discard the removed waste toner box. Store it in a plastic bag. The person in charge shall collect it for maintenance.

5

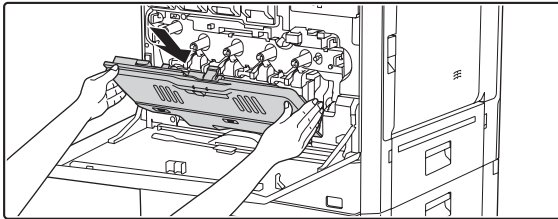

### Install the new waste toner box.

Insert the box from above at a slant. (The direction opposite to when you removed it.)

6

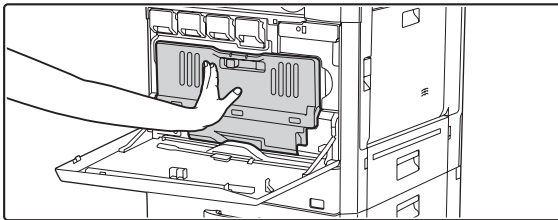

### Push the waste toner box into the machine.

Push the box in until it clicks into place.

7

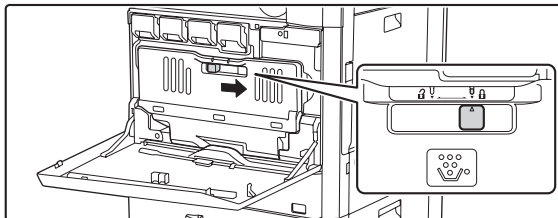

### Lock the waste toner box.

Move the lock of the waste toner box to the lock position.

8

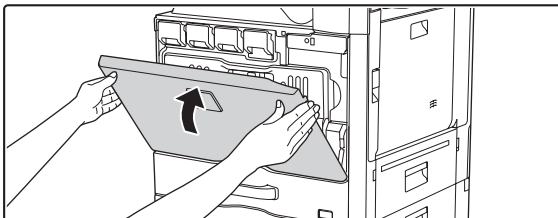

### Close the front cover.

#### Caution

- Do not throw the waste toner box into a fire. Toner may fly and cause burns.
- Store the waste toner box out of the reach of small children.



When replacing the waste toner box, be aware that it may soil your clothes or the immediate surroundings.

# REPLACING THE STAMP CARTRIDGE

If a stamp unit (AR-SU1) is installed on the automatic document feeder and the stamp has become faint, replace the stamp cartridge (AR-SV1).

## Supplies

Stamp cartridge (2 in package) AR-SV1

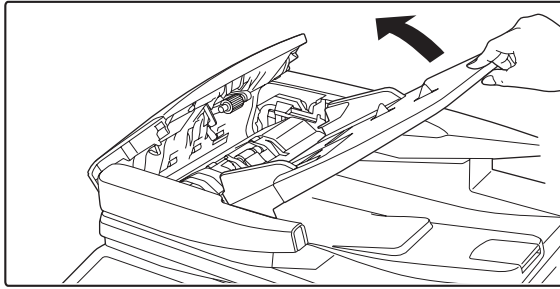
**1**

Open the document feeder tray

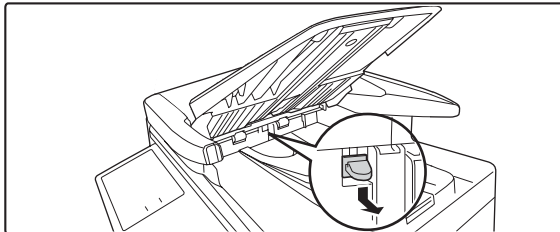
**2**

Remove the stamp cartridge while pushing it downwards

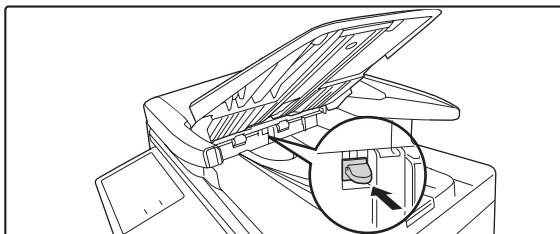
**3**

Install a new stamp cartridge.

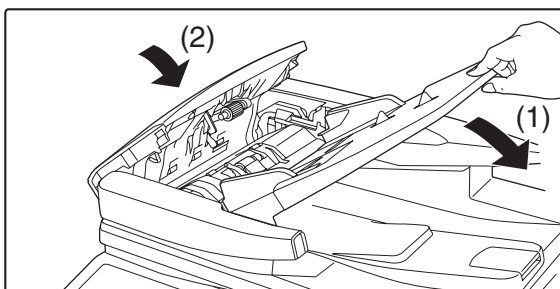











**4**









Close the document feeder tray then close the document feeding area cover.

# ENTERING TEXT



This section explains the text entry screen.

## FUNCTIONS OF THE MAIN KEYS

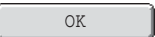
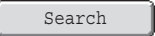
Key	Description
	<p>This changes the text entry screen from the lower case screen to the upper case screen. The upper case screen will continue to appear until the [Caps] key is touched again so that it is no longer highlighted. The [Caps] key is convenient when you wish to enter all capital letters. (This key will vary depending on your country or region.)</p>
	<p>This key temporarily changes the keys in the text entry screen to upper case when lower case letters appear, or to lower case when upper case letters appear. Touch a letter key after touching the [Shift] key to enter that letter. After the letter is entered, the [Shift] key will no longer be highlighted and the original text entry screen will appear. The [Shift] key is convenient when you only need to enter one upper case letter or one lower case letter, or when you need to enter one of the symbols assigned to the numeric keys. To cancel selection of the [Shift] key, touch the [Shift] key again. The [Shift] key will no longer be highlighted. (This key will vary depending on your country or region.)</p>
	<p>Touch this key to enter a line break when entering the body text of an e-mail message. (This key will vary depending on your country or region.)</p>
	<p>Touch this key to delete the characters to the left of the cursor one character at a time.</p>
	<p>Touch this key to temporarily change the key layout of character entry mode to a different language. Select the key layout that you wish to use.</p>
	<p>Touch this key to enter a space between letters.</p>
	<p>This temporarily changes the entry screen to the accented letter and symbol entry screen. Touch a letter key after touching the [AltGr] key to enter that letter. After the letter is entered, the [AltGr] key will no longer be highlighted and the original text entry screen will appear. To cancel selection of the [AltGr] key, touch the [AltGr] key again. The [AltGr] key will no longer be highlighted.</p>
	<p>These keys move the cursor left and right.</p>
	<p>These keys move the cursor to the line above or below the current line during entry of the body text of an e-mail message.</p>
	<p>Touch this key to select character entry mode.</p>
	<p>Touch this key to select symbol entry mode. Symbol mode is used to enter symbols and accented letters.</p>
	<p>Use this to retrieve a previously stored subject for e-mail or other pre-set text.</p>

Key	Description
	Shows explanations of each key.
     	Use this to enter a previously stored text string such as ".com". Text strings are stored in the system settings.  7. SYSTEM SETTINGS " <a href="#">Soft Keyboard Template Setting</a> " (page 7-67)
	Touch this key to return to the previous setting screen without entering text.
	Touch this key to enter the text that currently appears and return to the previous setting screen.
	Search results will appear based on the entered characters.



- Some keys described above may not appear in certain key layouts or in the keyboards of certain countries or regions.
- "◀" in the text entry screen indicates how many characters can be entered. A number of characters greater than "◀" cannot be entered.
- On some keyboards that show the English alphabet, the [AltGr] screen continues to appear until the [AltGr] key is touched to remove the highlighting.
- The  key is only displayed in limited countries and regions. The  key is a shortcut key to switch the keyboard between the language of your region and English.
- The key layouts that can be selected vary depending on the language selected in "Display Language Setting" in the system settings (administrator).
- The following symbols cannot be used when entering a file name or folder name.  
\ ? / " ; : , < > ! \* | & #  
Some computer environments may not allow the use of spaces and the symbols indicated below. For example, hyperlinks will not operate correctly or nonsense characters may appear.  
\$ % ' ( ) + - . = @ [ ] ^ ` { } \_ ~

## KEYBOARD

### Entering text from an external keyboard

An external keyboard can only be used as an alternative for the text entry screen that appears in the machine's touch panel. The layout of the keys in the text entry screen in the touch panel differs slightly from the layout of the keys on the external keyboard.

Use a SHARP-recommended external keyboard.

For the recommended keyboards, please contact your dealer or nearest authorised service representative.

### Entering text from a keyboard (MX-KB14 N)

A keyboard can only be used as an alternative for the text entry screen that appears in the machine's touch panel. The layout of the keys in the text entry screen in the touch panel differs slightly from the layout of the keys on the keyboard. For details on using the keys, press the F1 key to view an explanation of each key.

To use the keyboard, pull it out from under the operation panel. When not in use, store the keyboard under the operation panel.

Always hold the keyboard by the handle when storing it. You may pinch your fingers if you hold the keyboard elsewhere.



- MX-KB14 N may not be available in some countries and regions.
- Do not place heavy objects on the keyboard or press down on the keyboard.



# CHAPTER 2

# COPIER

This chapter provides detailed explanations of the procedures for using the copy function.

## BEFORE USING THE MACHINE AS A COPIER

BASE SCREEN OF COPY MODE .....	2-3
COPYING SEQUENCE .....	2-6
ORIGINALS .....	2-9
• CHECKING THE ORIGINAL SIZE .....	2-9
PAPER TRAYS.....	2-11

## BASIC PROCEDURE FOR MAKING COPIES

MAKING COPIES.....	2-12
• USING THE AUTOMATIC DOCUMENT FEEDER TO MAKE COPIES .....	2-12
• MAKING A COPY USING THE DOCUMENT GLASS .....	2-14
AUTOMATIC 2-SIDED COPYING .....	2-16
• USING THE AUTOMATIC DOCUMENT FEEDER TO MAKE 2-SIDED COPIES .....	2-16
• AUTOMATIC 2-SIDED COPYING USING THE DOCUMENT GLASS .....	2-18
COPY COLOUR MODES.....	2-21
CHANGING THE EXPOSURE AND ORIGINAL IMAGE TYPE .....	2-23
• AUTOMATIC ADJUSTMENT OF THE EXPOSURE AND ORIGINAL TYPE .....	2-23
• SELECTING THE ORIGINAL TYPE AND MANUALLY ADJUSTING THE EXPOSURE .....	2-23
REDUCTION/ENLARGEMENT/ZOOM .....	2-25
• AUTOMATIC RATIO SELECTION (Auto Image) .....	2-25
• MANUALLY SELECTING THE RATIO (Preset ratios/Zoom).....	2-26
• ENLARGING/REDUCING THE LENGTH AND WIDTH SEPARATELY (XY Zoom) .....	2-28
ORIGINAL SIZES .....	2-29
• SPECIFYING THE ORIGINAL SIZE .....	2-29
• STORING FREQUENTLY USED ORIGINAL SIZES.....	2-30

OUTPUT .....	2-33
• OUTPUT MODES.....	2-35
MAKING COPIES USING THE BYPASS TRAY .....	2-38

## SPECIAL MODES

SPECIAL MODES .....	2-41
ADDING MARGINS (Margin Shift) .....	2-44
ERASING PERIPHERAL SHADOWS (Erase) .....	2-46
COPYING EACH FACING PAGE OF A BOUND DOCUMENT (Dual Page Copy).....	2-48
MAKING COPIES IN PAMPHLET FORMAT (Pamphlet Copy) .....	2-50
COPYING A LARGE NUMBER OF ORIGINALS AT ONCE (Job Build) .....	2-53
USING TWO MACHINES TO MAKE A LARGE NUMBER OF COPIES (Tandem Copy) .....	2-56
USING A DIFFERENT PAPER TYPE FOR COVERS (Covers/Inserts).....	2-59
• INSERTING COVERS IN COPIES (Cover Settings) .....	2-60
• INSERTING INSERT SHEETS IN COPIES (Insert Settings) .....	2-63
• CHANGING COVER/INSERT SETTINGS (Page Layout).....	2-67
ADDING INSERTS WHEN COPYING ON TRANSPARENCY FILM (Transparency Inserts) .....	2-70
COPYING MULTIPLE ORIGINALS ONTO ONE SHEET (Multi Shot).....	2-72
COPYING A PAMPHLET (Book Copy).....	2-74
COPYING CAPTIONS ONTO TAB PAPER (Tab Copy) .....	2-78
• RELATION BETWEEN THE ORIGINALS AND THE TAB PAPER.....	2-78

<b>COPYING BOTH SIDES OF A CARD ON ONE SHEET OF PAPER (Card Shot)</b> .....	<b>2-81</b>
<b>PRINTING THE DATE AND A STAMP ON COPIES (Stamp)</b> .....	<b>2-84</b>
• GENERAL PROCEDURE FOR USING STAMP .....	2-85
• ADDING THE DATE TO COPIES (Date) .....	2-88
• STAMPING COPIES (Stamp) .....	2-90
• PRINTING PAGE NUMBERS ON COPIES (Page Numbering) .....	2-92
• PRINTING TEXT ON COPIES (Text) .....	2-96
• CHECKING THE STAMP LAYOUT (Layout) .....	2-100
• ADDING A WATERMARK TO A COPY (Watermark) .....	2-102
<b>[Image Edit] KEY</b> .....	<b>2-104</b>
• REPEATING PHOTOS ON A COPY (Photo Repeat) .....	2-105
• CREATING A LARGE POSTER (Multi-Page Enlargement) .....	2-107
• REVERSING THE IMAGE (Mirror Image) ...	2-110
• COPYING A3 (11" x 17") ORIGINALS WITH NO EDGE CUT-OFF (A3 (11" x 17") Full Bleed) .....	2-111
• COPYING IN THE CENTRE OF THE PAPER (Centring) .....	2-113
<b>[Colour Adjustments] KEY</b> .....	<b>2-115</b>
• ADJUSTING RED/GREEN/BLUE IN COPIES (RGB Adjust) .....	2-116
• ADJUSTING THE SHARPNESS OF AN IMAGE (Sharpness) .....	2-117
• WHITENING FAINT COLOURS IN COPIES (Suppress Background) .....	2-118
• ADJUSTING THE COLOUR (Colour Balance) .....	2-120
• ADJUSTING THE BRIGHTNESS OF A COPY (Brightness) .....	2-122
• ADJUSTING THE INTENSITY OF A COPY (Intensity) .....	2-123
<b>CHECKING COPIES BEFORE PRINTING (Proof Copy)</b> .....	<b>2-124</b>
<b>CHECKING THE NUMBER OF SCANNED ORIGINAL SHEETS BEFORE COPYING (Original Count)</b> .....	<b>2-127</b>
<b>COPYING ORIGINALS OF DIFFERENT SIZES (Mixed Size Original)</b> .....	<b>2-129</b>
<b>COPYING THIN ORIGINALS (Slow Scan Mode)</b> .....	<b>2-132</b>

## CONVENIENT COPY FUNCTIONS

<b>INTERRUPTING A COPY RUN (Interrupt copy)</b> .....	<b>2-134</b>
<b>CHECKING A PREVIEW IMAGE OF A COPY (Preview)</b> .....	<b>2-136</b>
• PREVIEW SCREEN .....	2-138
<b>JOB STATUS SCREEN</b> .....	<b>2-139</b>
• JOB QUEUE SCREEN AND COMPLETED JOB SCREEN .....	2-140
• CANCELLING A JOB THAT IS WAITING IN THE QUEUE .....	2-142
• GIVING PRIORITY TO A JOB IN THE QUEUE .....	2-143
• CHECKING INFORMATION ON A COPY JOB WAITING IN THE QUEUE .....	2-144
<b>STORING COPY OPERATIONS (Job Programs)</b> .....	<b>2-145</b>
• STORING (EDITING/DELETING) A JOB PROGRAM .....	2-146
<b>APPENDIX</b> .....	<b>2-148</b>

# BEFORE USING THE MACHINE AS A COPIER

This section provides information that you should know before using the machine as a copier.

## BASE SCREEN OF COPY MODE

Touch the [COPY] key in the touch panel to open the base screen of copy mode.

The base screen shows messages and keys necessary for copying, and settings that have been selected.

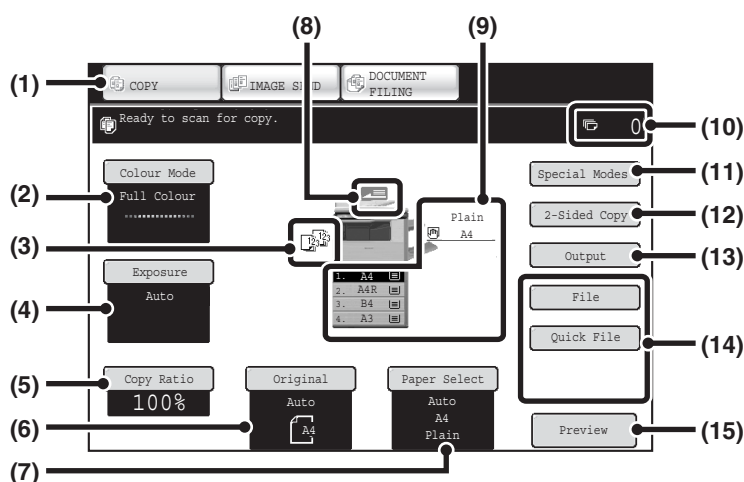

### (1) Mode Select keys

Use these keys to switch between copy, image send, and document filing modes.

If you wish to switch to copy mode, touch the [COPY] key.

### (2) [Colour Mode] key

Touch this to change the colour mode.

➤ [COPY COLOUR MODES](#) (page 2-21)

### (3) Output display

When one or more output functions such as sort, group, or staple sort have been selected, this shows the icons of the selected functions.

➤ [OUTPUT](#) (page 2-33)

### (4) [Exposure] key

This shows the current copy exposure and original type settings. Touch this key to change the exposure or original type setting.

➤ [CHANGING THE EXPOSURE AND ORIGINAL IMAGE TYPE](#) (page 2-23)

### (5) [Copy Ratio] key

This shows the current copy ratio. Touch this key to adjust the copy ratio.

➤ [REDUCTION/ENLARGEMENT/ZOOM](#) (page 2-25)

### (6) [Original] key

Touch this key to enter the original size manually.

When an original is placed, the detected original size is displayed. If the original size is set manually, the set size appears.

➤ [ORIGINAL SIZES](#) (page 2-29)

### (7) [Paper Select] key

Touch this key to change the paper (tray) that is used.

The tray, paper size, and paper type will appear. Trays 1 to 4 can also be touched in the paper size display to open the same screen.

➤ [PAPER TRAYS](#) (page 2-11)

### (8) Original feed display

This appears when an original is inserted in the automatic document feeder.

**(9) Paper select display**

This shows the size of paper loaded in each tray.  
For the bypass tray, the paper type appears above the paper size.

The selected tray is highlighted.

The approximate amount of paper in each tray is indicated by . Trays 1 to 4 can be touched to open the same screen as when the [Paper Select] key is touched.

[PAPER TRAYS](#) (page 2-11)

**(10) Number of copies display**

This shows the number of copies set.

**(11) [Special Modes] key**

Touch this key to select special modes such as Margin Shift, Edge Erase, and Dual Page Copy.

[SPECIAL MODES](#) (page 2-41)

**(12) [2-Sided Copy] key**

Touch this key to select the 2-sided copying function.

[AUTOMATIC 2-SIDED COPYING](#) (page 2-16)

**(13) [Output] key**

Touch this to select an output function such as sort, group, offset, staple sort, or punch.

[OUTPUT](#) (page 2-33)

**(14) Customized keys**

The keys that appear here can be changed to show settings or functions that you prefer. The following keys appear by factory default:

[Customizing displayed keys](#) (page 2-5)

**[File] key, [Quick File] key**

Touch one of these keys to use the File function or Quick File function of document filing mode. These are the same [File] and [Quick File] keys that appear when the [Special Modes] key is touched. For information on the document filing function, see "6. DOCUMENT FILING". (On the MX-2314N, the productivity kit is required.)

**(15) [Preview] key**

Touch to view a preview image of a copy in the touch panel before printing the copy.

[CHECKING A PREVIEW IMAGE OF A COPY \(Preview\)](#) (page 2-136)

(On the MX-2314N, the productivity kit is required.)

The screen explained in this section appears when a paper drawer, right tray, finisher, and punch module are installed. The image will vary depending on the equipment installed.

## Tray during paper feeding

Do not pull out a tray while paper is being fed from the tray. This will cause a paper misfeed.

### Identifying the tray that is being used to feed paper

- (1) While paper is feeding, the job status display of the system bar on the touch panel screen will show the number of the tray that is being used to feed paper.
- (2) The tray being used to feed paper also appears in green in the paper size display in the base screen on the touch panel.

**Base screen**

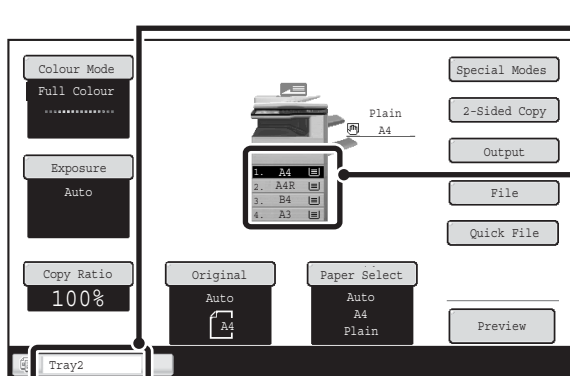

- (1) **Job status display on the system bar**  
Shows the number of the tray being used to feed paper.
- (2) **Paper size display**  
Shows the tray being used to feed paper in green.

## Customizing displayed keys

Special mode keys and other keys can be displayed in the base screen. By assigning frequently used functions to these keys, you can access the functions with a single touch. To change the function that is assigned to a key, use "Customize Key Setting" in the Web pages.

### When "Erase", "Margin Shift", and "Brightness" are assigned to the customized keys

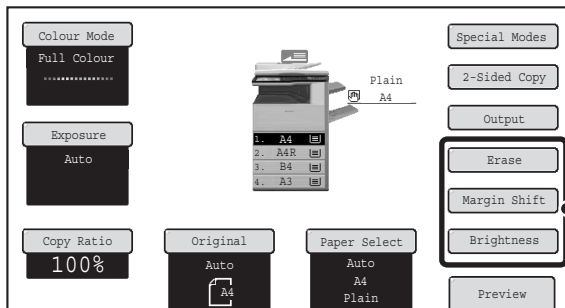

These 3 keys can be changed as desired.



#### System Settings (Administrator): Customize Key Setting

Registration is performed in [System Settings] - [Operation Settings] - "Customize Key Setting" in the Web page menu.

## Checking what special modes are selected

The  key appears in the base screen when one or more special modes are selected.

The  key can be touched to display the selected special modes. To close the screen, touch the [OK] key.

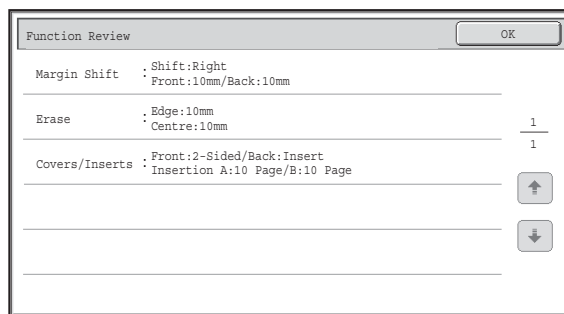
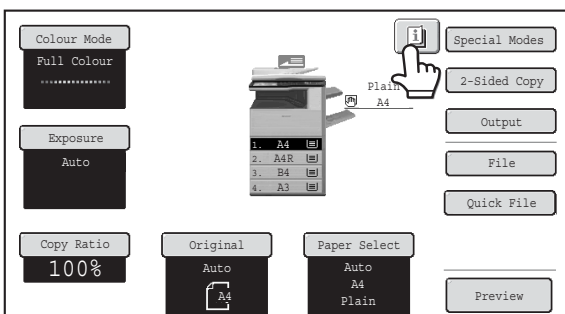

# COPYING SEQUENCE

This section explains the basic procedure for copying. Select settings in the order shown below to ensure that the copy operation takes place smoothly.

For detailed procedures for selecting the settings, see the explanation of each setting in this chapter.

## Place the original.

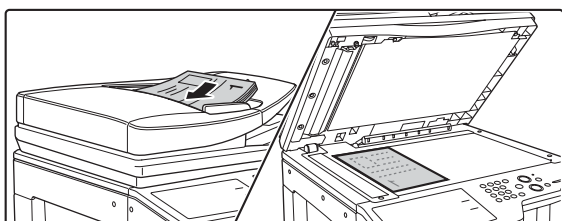

Place the original in the document feeder tray of the automatic document feeder, or on the document glass.

\* Depending on the copy functions used, there are also cases where functions are selected before the original is placed.



## Basic copy settings

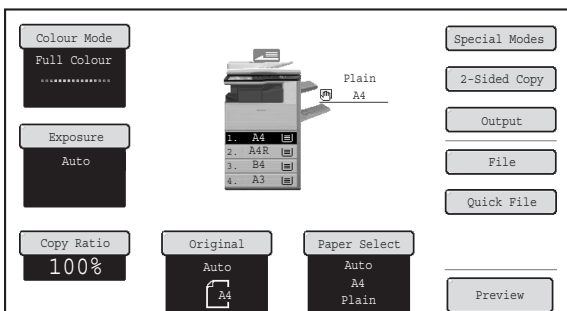

Select the basic copy settings.

The main settings are as follows:

- Colour mode [COPY COLOUR MODES](#) (page 2-21)
- Exposure and original type [CHANGING THE EXPOSURE AND ORIGINAL IMAGE TYPE](#) (page 2-23)
- Copy ratio [REDUCTION/ENLARGEMENT/ZOOM](#) (page 2-25)
- Original size [ORIGINAL SIZES](#) (page 2-29)
- Paper Settings [PAPER TRAYS](#) (page 2-11)



## 2-sided copy settings



Select settings as needed for 2-sided copying and 2-sided scanning of the original.

- [AUTOMATIC 2-SIDED COPYING](#) (page 2-16)



## Output settings

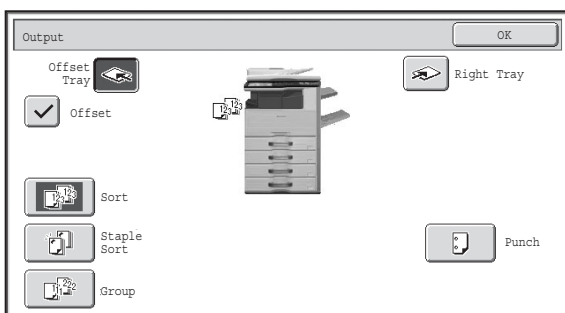

Select copy output settings.

The main settings are as follows:

- Sort mode [Sort mode](#) (page 2-35)
- Group mode [Group mode](#) (page 2-35)
- Offset mode [Offset function](#) (page 2-35)
- Staple sort mode
  - [Staple sort function](#) (page 2-36)
- Punch function [Punch function](#) (page 2-37)



## Special mode settings

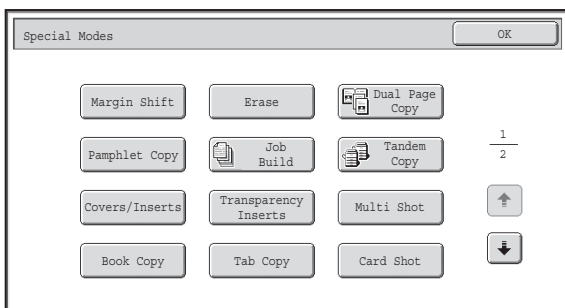

Select special modes such as "Margin Shift" and "Erase".

[SPECIAL MODES](#) (page 2-41)



## Number of copies (sets) setting

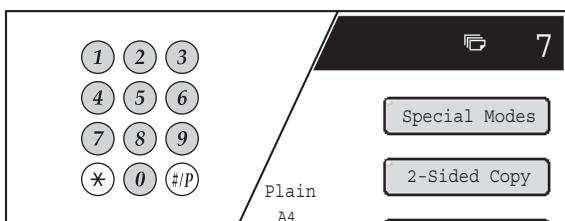

Set the number of copies (number of sets).





## Start copying.

Start scanning the original(s) and making copies.

Press the [COLOUR START] key or the [BLACK & WHITE START] key.





- When one or more special modes are selected, the  key appears in the base screen. Touch the  key to display a list of the selected special modes. This lets you check what special modes are selected and the settings of each mode.  
➤ [Checking what special modes are selected](#) (page 2-5)
- To store a copy job using the document filing function, select copy settings and then touch the [File] key or the [Quick File] key.



**To cancel all settings, press the [CLEAR ALL] key (  ).**

When the [CLEAR ALL] key (  ) is pressed, all settings selected to that point are cleared and you will return to the base screen.

**To stop scanning of the original and copying, press the [STOP] key (  ).**

When the [STOP] key (  ) is pressed, a message will appear asking you if you want to cancel the job. Touch the [Yes] key in the message screen.



# ORIGINALS

## CHECKING THE ORIGINAL SIZE

When [Auto] appears in the [Original] key, the size of the placed original is automatically detected. The machine automatically detects the original size when an original is placed and displays the size in the [Original] key in the base screen.

### Example of base screen

The original size is displayed.

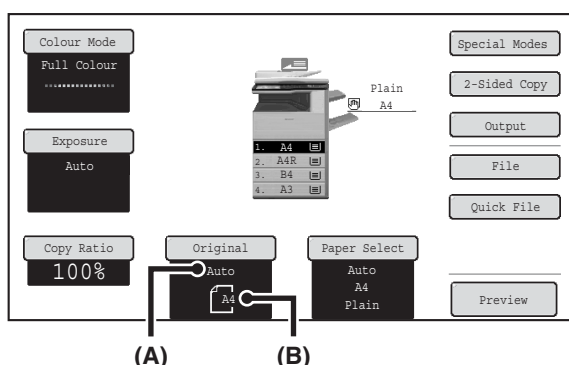



- (A) "Auto" appears when the automatic original detection function is operating.
- (B) The original size is displayed. An icon shows the orientation of the original.

## Standard sizes

Standard sizes are sizes that the machine can automatically detect. The standard sizes are set in "Original Size Detector Setting" in the system settings (administrator). The factory default setting is "AB-1 (Inch-1)".

### List of original size detector settings

Selections	Standard sizes (detected original sizes)	
	Document glass	Document feeder tray (automatic document feeder)
AB-1	A3, A4, A4R, A5, B4, B5, B5R	A3, A4, A4R, A5, B4, B5, B5R, 8-1/2" x 11", 8-1/2" x 14", 11" x 17"
AB-2	A3, A4, A4R, A5, B5, B5R, 216 mm x 330 mm (8-1/2" x 13")	A3, A4, A4R, A5, B4, B5, B5R, 8-1/2" x 11", 11" x 17", 216 mm x 330 mm (8-1/2" x 13")
AB-3	A4, A4R, A5, B4, 8K, 16K, 16KR	A3, A4, A4R, A5, B4, 8K, 16K, 16KR, 8-1/2" x 11", 11" x 17", 216 mm x 330 mm (8-1/2" x 13")
AB-4	A3, A4, A4R, A5, B5, B5R, 216 mm x 340 mm (8-1/2" x 13-2/5")	A3, A4, A4R, A5, B4, B5, B5R, 8-1/2" x 11", 11" x 17", 216 mm x 340 mm (8-1/2" x 13-2/5")
AB-5	A3, A4, A4R, A5, B5, B5R, 216 mm x 343 mm (8-1/2" x 13-1/2")	A3, A4, A4R, A5, B4, B5, B5R, 8-1/2" x 11", 11" x 17", 216 mm x 343 mm (8-1/2" x 13-1/2")
Inch-1	11" x 17", 8-1/2" x 14", 8-1/2" x 11", 8-1/2" x 11"R, 5-1/2" x 8-1/2"	11" x 17", 8-1/2" x 14", 8-1/2" x 11", 8-1/2" x 11"R, 5-1/2" x 8-1/2", A4, A3
Inch-2	11" x 17", 8-1/2" x 13" (216 mm x 330 mm), 8-1/2" x 11", 8-1/2" x 11"R, 5-1/2" x 8-1/2"	11" x 17", 8-1/2" x 13" (216 mm x 330 mm), 8-1/2" x 11", 8-1/2" x 11"R, 5-1/2" x 8-1/2", A4, A3
Inch-3	11" x 17", 8-1/2" x 13-2/5" (216 mm x 340 mm), 8-1/2" x 11", 8-1/2" x 11"R, 5-1/2" x 8-1/2"	11" x 17", 8-1/2" x 13-2/5" (216 mm x 340 mm), 8-1/2" x 11", 8-1/2" x 11"R, 5-1/2" x 8-1/2", A3, A4

- 
 When the automatic original detection function is operating and the original is a non-standard size (an inch size or special size), the closest standard size may be displayed or the original size may not appear. In this event, manually set the correct original size.
  -  [SPECIFYING THE ORIGINAL SIZE](#) (page 2-29)
- When placing a non-standard size original on the document glass, you can make it easier for the size to be detected by placing a blank sheet of A4 (8-1/2" x 11"), B5 (5-1/2" x 8-1/2"), or other standard size of paper on top of the original.

## Standard original placement orientations

Place originals in the document feeder tray or on the document glass so that the top and bottom of the original are oriented as shown in the illustration. If the original is not oriented correctly and a function such as stapling is selected, the staple positions may not be correct. For more information on placing the original, see "ORIGINALS" (page 1-38) in "1. BEFORE USING THE MACHINE".

### [Example 1]

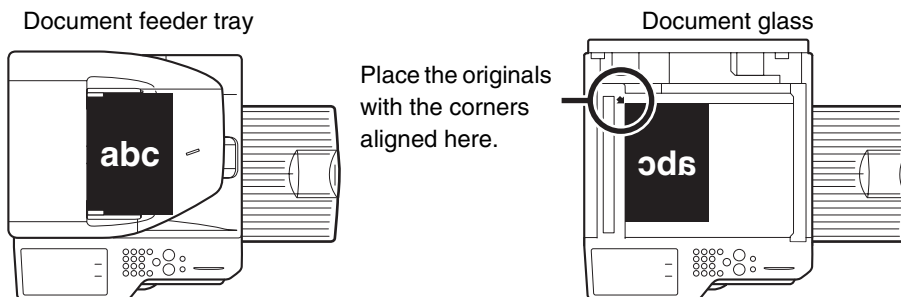

### [Example 2]

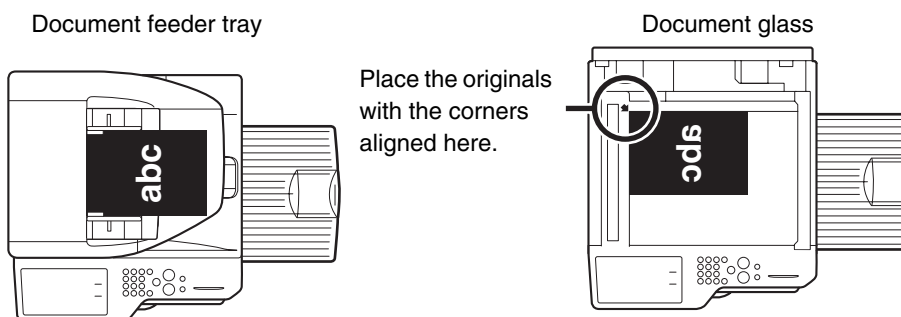

## Automatic copy image rotation (Rotation Copy)

If the orientation of the original and paper are different, the original image will be automatically rotated 90 degrees to match the paper. (When an image is rotated, a message is displayed.)

### [Example]

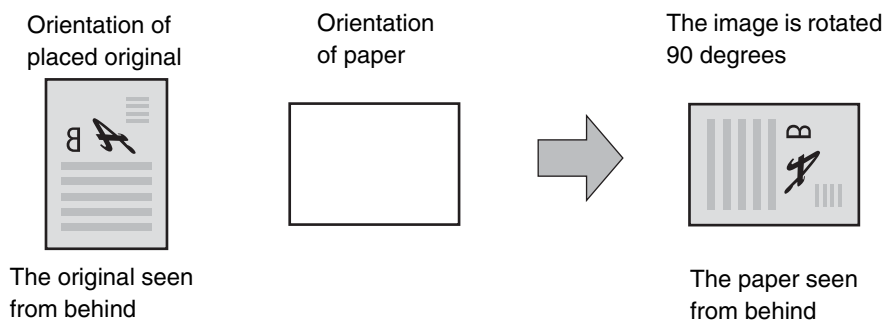

This function operates in both auto paper selection mode and auto image mode. Rotation can be disabled using "Rotation Copy Setting" in the System Settings (Administrator).

# PAPER TRAYS

The machine is set to automatically select a tray that has the same size of paper as the size of the placed original (automatic paper tray selection).

If the correct paper size is not selected or you wish to change the paper size, you can select the paper tray manually.

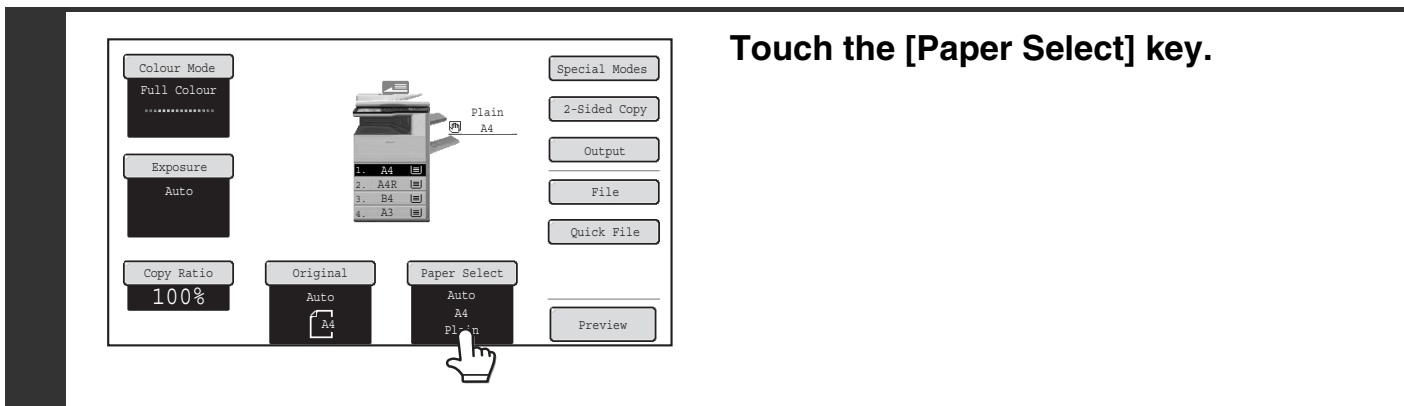

Touch the [Paper Select] key.

1



You can also touch the paper size display (A) to open the paper tray settings.

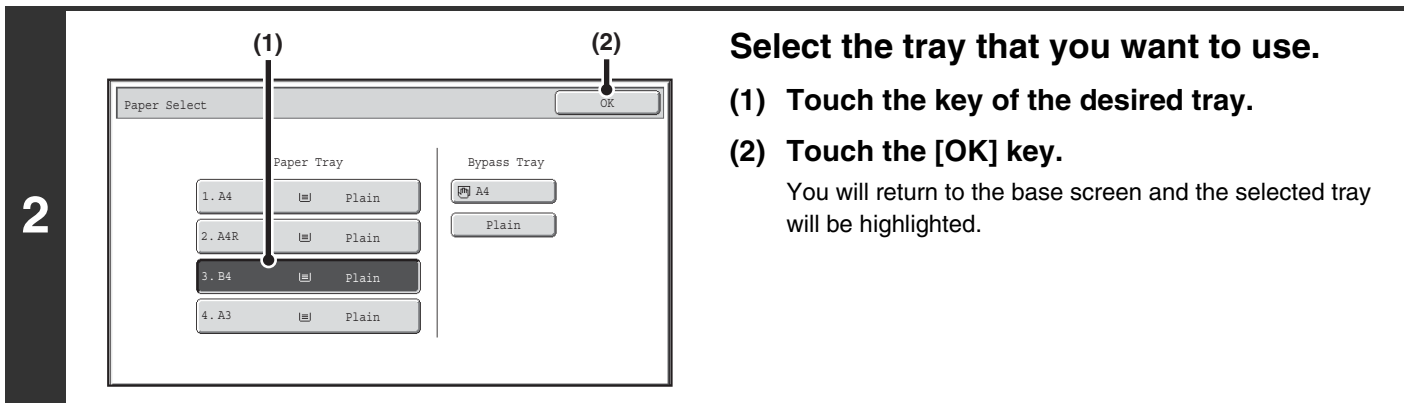
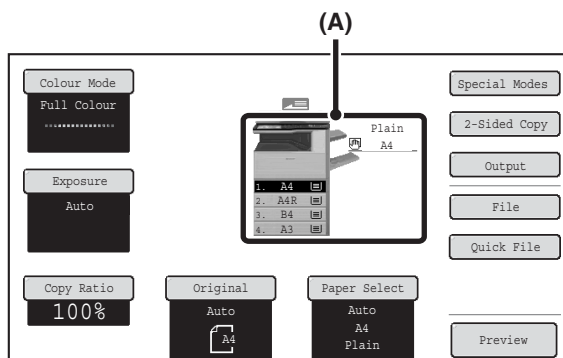

2

Select the tray that you want to use.

(1) Touch the key of the desired tray.

(2) Touch the [OK] key.

You will return to the base screen and the selected tray will be highlighted.

If the selected tray runs out of paper during a copy job and there is another tray that has the same size and type of paper, that tray will be automatically selected and the copy job will continue.

To return to automatic paper tray selection after selecting a tray manually, press the [CLEAR ALL] key (CA).

**System Settings (Administrator): Initial Status Settings (Paper Tray)**  
Use this setting to change the tray that is selected by default.

# BASIC PROCEDURE FOR MAKING COPIES

This section explains the basic procedures for making copies, including selection of the copy ratio and other copy settings.

## MAKING COPIES

### USING THE AUTOMATIC DOCUMENT FEEDER TO MAKE COPIES

This section explains how to make copies (1-sided copies of 1-sided originals) using the automatic document feeder.

1

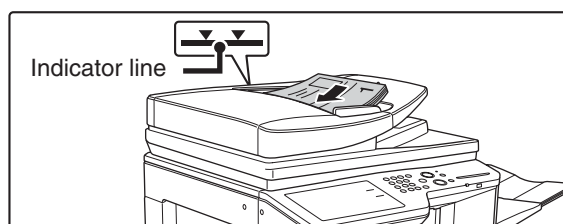

**Place the originals face up in the document feeder tray with the edges aligned evenly.**

Insert the originals all the way into the document feeder tray. Multiple originals can be placed in the document feeder tray. The stack of originals must not be higher than the indicator line on the tray.

2

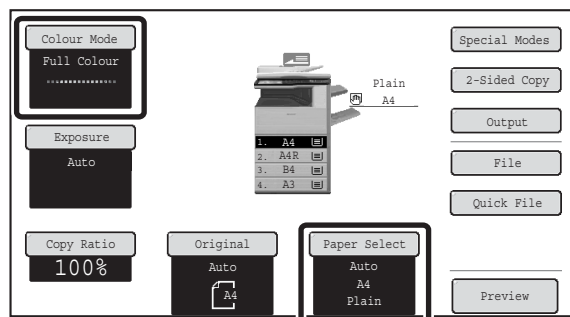

**Check the paper to be used and the colour mode.**

Make sure that the desired paper (tray) and colour mode are selected.

- To change the paper (tray), touch the [Paper Select] key.
  - ➔ [PAPER TRAYS](#) (page 2-11)
- To change the colour mode, touch the [Colour Mode] key.
  - ➔ [COPY COLOUR MODES](#) (page 2-21)



Depending on the size of the placed original, there may be cases where the same size of paper as the original is not selected automatically. In this event, change the paper size manually.

3

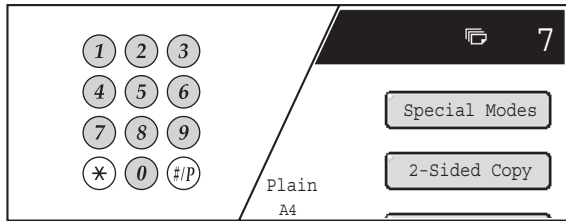

**Set the number of copies (number of sets) with the numeric keys.**



- Up to 999 copies (sets) can be set.
- A single copy can be made even if "0" appears for the number of copies.



**If an incorrect number of copies is set...**

Press the [CLEAR] key (C) and then enter the correct number.

4

**Press the [COLOUR START] key or the [BLACK & WHITE START] key.**



Even if a colour mode is selected, copying will take place in black and white if the [BLACK & WHITE START] key is pressed.



**To cancel scanning of the original and copying...**

Press the [STOP] key (⏹).

# MAKING A COPY USING THE DOCUMENT GLASS

To make a copy of a book or other thick original that cannot be scanned with the automatic document feeder, open the automatic document feeder and place the original on the document glass. This section explains how to make a copy (1-sided copy of a 1-sided original) using the document glass.

1

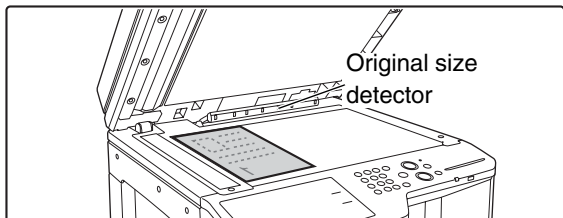

Open the automatic document feeder, place the original face down on the document glass, and then gently close the automatic document feeder.

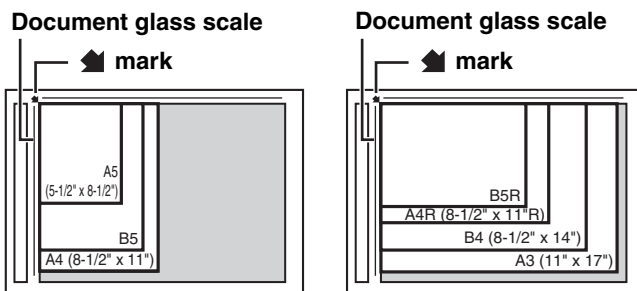

- Align the corner of the original with the tip of the arrow mark  on the document glass scale.
- Place the original in the appropriate position for its size as shown above.
- After placing the original, be sure to close the automatic document feeder. If left open, parts outside of the original will be copied black, causing excessive use of toner.



Do not place any objects under the original size detector. Closing the automatic document feeder with an object underneath may damage the original size detector plate and prevent correct detection of the document size.

2

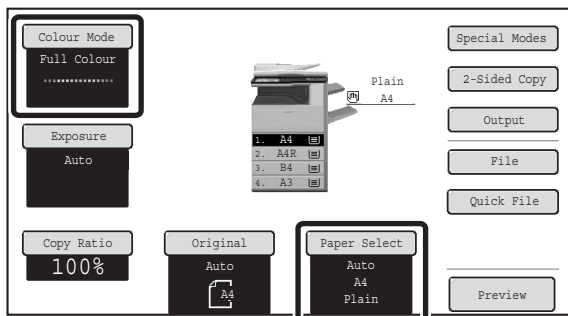

## Check the paper to be used and the colour mode.

Make sure that the desired paper (tray) and colour mode are selected.

- To change the paper (tray), touch the [Paper Select] key.
  - [PAPER TRAYS](#) (page 2-11)
- To change the colour mode, touch the [Colour Mode] key.
  - [COPY COLOUR MODES](#) (page 2-21)



Depending on the size of the placed original, there may be cases where the same size of paper as the original is not selected automatically. In this event, change the paper size manually.

3

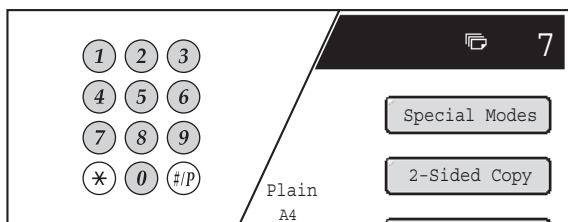

Set the number of copies (number of sets) with the numeric keys.



- Up to 999 copies (sets) can be set.
- A single copy can be made even if "0" appears for the number of copies.



**If an incorrect number of copies is set...**

Press the [CLEAR] key (Ⓢ) and then enter the correct number.

4

Press the [COLOUR START] key or the [BLACK & WHITE START] key.

Normally copying will start.

Depending on the copy settings (2-sided copying, etc.), copying may not begin until all originals have been scanned. In this case, go to the next step.



Even if a colour mode is selected, copying will take place in black and white if the [BLACK & WHITE START] key is pressed.

5

Remove the original and place the next original, and then press the [COLOUR START] key or the [BLACK & WHITE START] key.

Repeat this step until all originals have been scanned.

For the second original and following originals, use the same [START] key as you did for the first original.

6

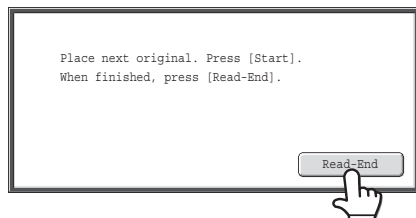

Touch the [Read-End] key.



**To cancel scanning of the original and copying...**

Press the [STOP] key (Ⓢ).

# AUTOMATIC 2-SIDED COPYING

## USING THE AUTOMATIC DOCUMENT FEEDER TO MAKE 2-SIDED COPIES

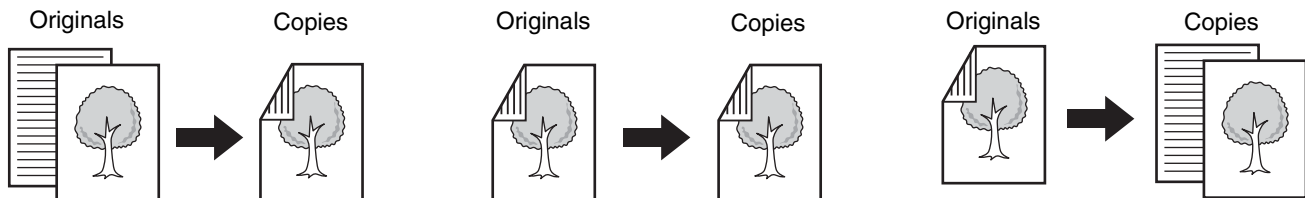

Automatic 2-sided copying of 1-sided originals

Automatic 2-sided copying of 2-sided originals

1-sided copying of 2-sided originals

Copying onto both sides of a sheet saves paper.

1

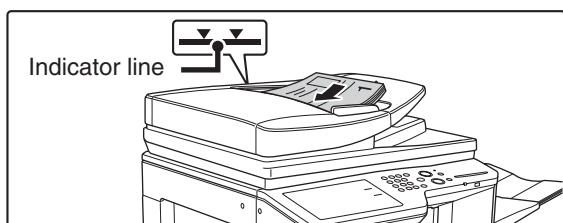

**Place the originals face up in the document feeder tray with the edges aligned evenly.**

Insert the originals all the way into the document feeder tray. Multiple originals can be placed in the document feeder tray. The stack of originals must not be higher than the indicator line on the tray.

2

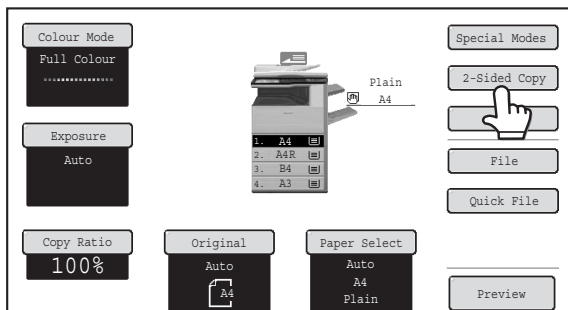

**Touch the [2-Sided Copy] key.**

3

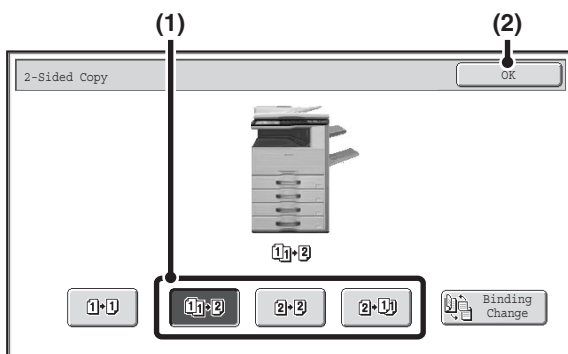

**Select the 2-sided copy mode.**

(1) Touch the key of the desired mode.

- : Automatic 2-sided copying of 1-sided originals
- : Automatic 2-sided copying of 2-sided originals
- : 1-sided copying of 2-sided originals

(2) Touch the [OK] key.



To make 2-sided copies of a 1-sided portrait original placed horizontally, or to invert the reverse side with respect to the front side when copying a 2-sided original, touch the [Binding Change] key.

Using the [Binding Change] key (page 2-17)



4

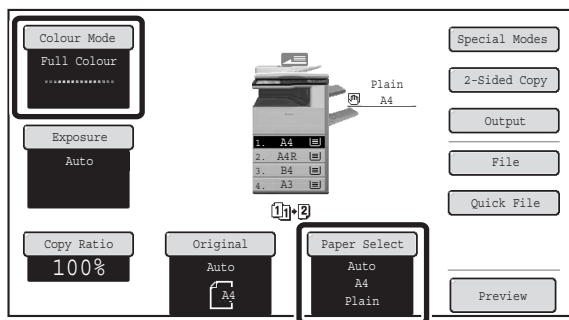

**Check the paper to be used and the colour mode.**

Make sure that the desired paper (tray) and colour mode are selected.

- To change the paper (tray), touch the [Paper Select] key.
  - PAPER TRAYS (page 2-11)
- To change the colour mode, touch the [Colour Mode] key.
  - COPY COLOUR MODES (page 2-21)



Depending on the size of the placed original, there may be cases where the same size of paper as the original is not selected automatically. In this event, change the paper size manually.

5

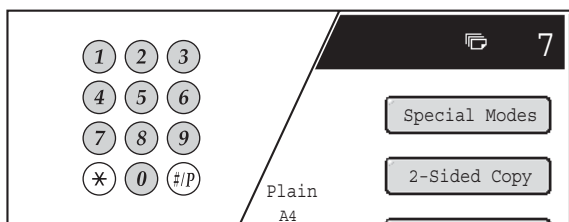

**Set the number of copies (number of sets) with the numeric keys.**



- Up to 999 copies (sets) can be set.
- If you are only making a single copy, the copy can be made with the copy number display showing "0".



**If an incorrect number of copies is set...**  
Press the [CLEAR] key (C) and then enter the correct number.

6

**Press the [COLOUR START] key or the [BLACK & WHITE START] key.**



**To cancel scanning of the original and copying...**  
Press the [STOP] key (⊘).

**Using the [Binding Change] key**

Originals	Binding Change is used	Binding Change is not used
	<p>The reverse side is upside down.</p> <p>Select this when the pages will be bound into a tablet.</p>	<p>The reverse side is not upside down.</p> <p>Select this when the pages will be bound into a booklet.</p>

# AUTOMATIC 2-SIDED COPYING USING THE DOCUMENT GLASS

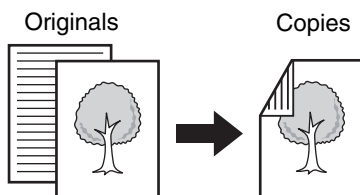

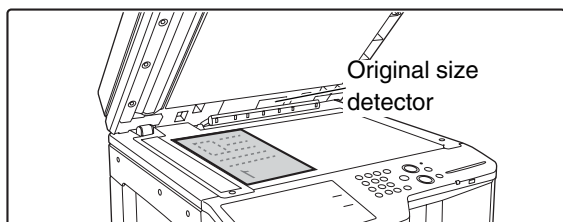

Automatic 2-sided copying of 1-sided originals

1

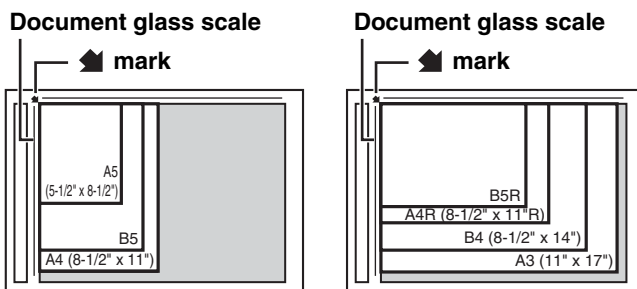

Open the automatic document feeder, place the original face down on the document glass, and then gently close the automatic document feeder.



- Align the corner of the original with the tip of the arrow mark  on the document glass scale.
- Place the original in the appropriate position for its size as shown above.
- After placing the original, be sure to close the automatic document feeder. If left open, parts outside of the original will be copied black, causing excessive use of toner.



Do not place any objects under the original size detector. Closing the automatic document feeder with an object underneath may damage the original size detector plate and prevent correct detection of the document size.

2

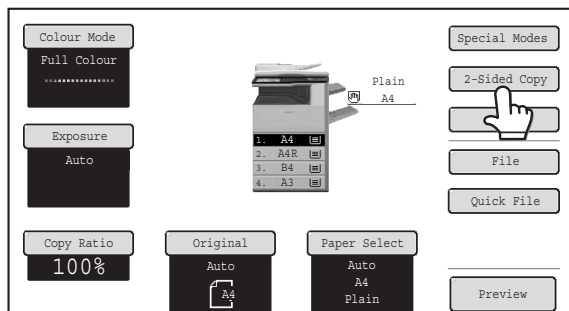

Touch the [2-Sided Copy] key.

3

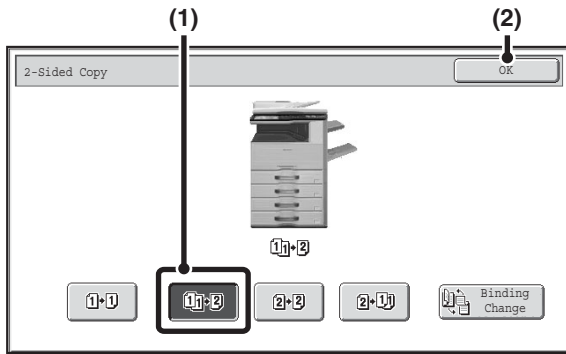

**Select the 2-sided copy mode.**

- (1) Touch the [1-Sided to 2-Sided] key.
- (2) Touch the [OK] key.



The [2-Sided to 2-Sided] key and [2-Sided to 1-Sided] key cannot be used when copying from the document glass.

4

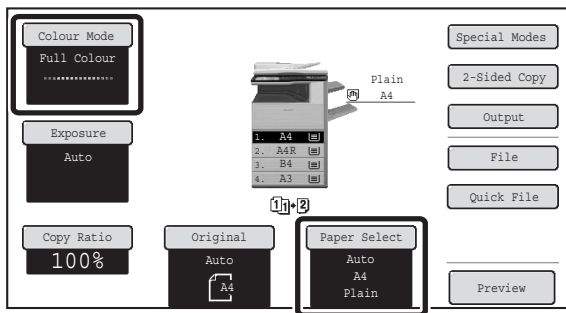

**Check the paper to be used and the colour mode.**

Make sure that the desired paper (tray) and colour mode are selected.

- To change the paper (tray), touch the [Paper Select] key.
  - [PAPER TRAYS](#) (page 2-11)
- To change the colour mode, touch the [Colour Mode] key.
  - [COPY COLOUR MODES](#) (page 2-21)



Depending on the size of the placed original, there may be cases where the same size of paper as the original is not selected automatically. In this event, change the paper size manually.

5

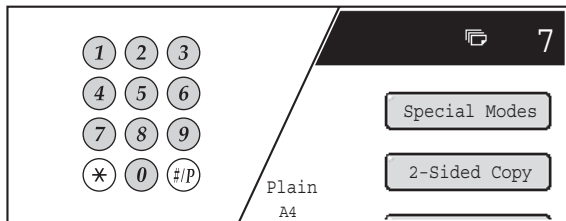

**Set the number of copies (number of sets) with the numeric keys.**



- Up to 999 copies (sets) can be set.
- A single copy can be made even if "0" appears for the number of copies.



**If an incorrect number of copies is set...**  
Press the [CLEAR] key (C) and then enter the correct number.

6

**Press the [COLOUR START] key or the [BLACK & WHITE START] key.**

Scanning begins.

7

**Remove the original and place the next original, and then press the [COLOUR START] key or the [BLACK & WHITE START] key.**

Repeat this step until all originals have been scanned.  
For the second original and following originals, use the same [START] key as you did for the first original.

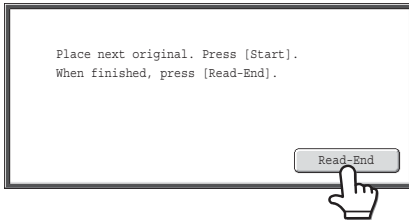

Touch the [Read-End] key.



**To cancel scanning of the original and copying...**

Press the [STOP] key (⏹).



**System Settings (Administrator): Initial Status Settings (2-Sided Copy)**

The default 2-sided copy mode can be changed.

# COPY COLOUR MODES

The colour mode of the [COLOUR START] key is normally set to [Full Colour] so that copying takes place in full colour mode when the [COLOUR START] key is pressed. If colour originals are mixed together with black & white originals, set the colour mode to [Auto] to have the colour mode change appropriately for each original.

Touch the [Colour Mode] key in the base screen to open the following screen.

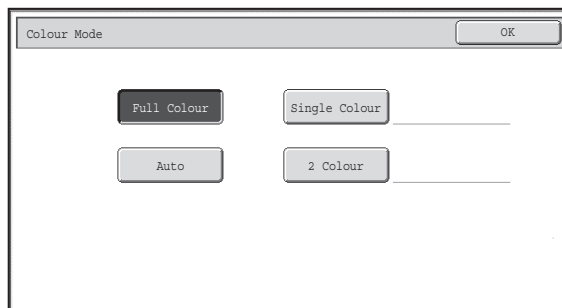

Touch the key of the desired colour mode and then touch the [OK] key.

<b>Full Colour</b>	The original is copied in full colour.
<b>Auto</b>	The machine automatically detects whether each original is colour or black & white and switches the mode appropriately (full colour for a colour original or black & white for a black & white original).
<b>Single Colour</b>	The original is copied in the selected colour only. All colours in the original are changed to the selected colour, which can be selected from red, green, blue, cyan, magenta, or yellow.
<b>2 Colour</b>	Only the red areas of the original are changed to the selected colour; colours other than red are copied in black. This lets you make copies that are more expressive than black and white copies. Red, green, blue, cyan, magenta, or yellow can be selected.

## Selecting single colour copying

When [Single Colour] is selected for the colour mode, the following screen appears. Touch the desired colour and touch the [OK] key.

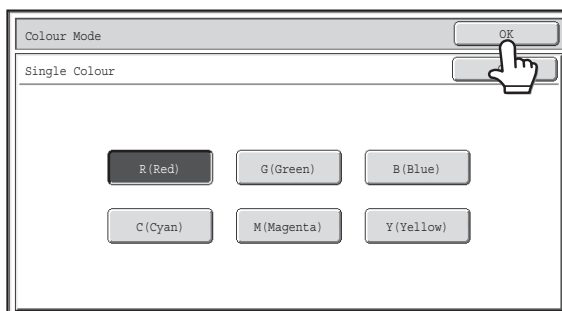

## Selecting 2 colour copying

When [2 Colour] is selected for the colour mode, the following screen appears. Touch the desired colour and touch the [OK] key.

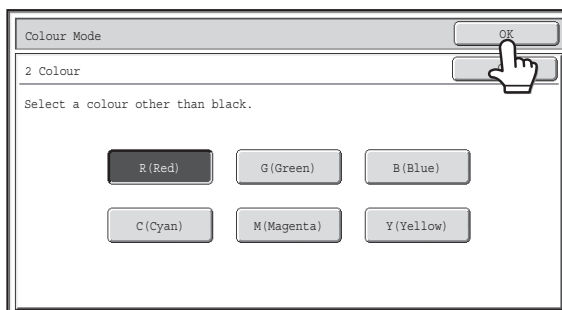

- When auto mode is used, there may be some originals for which switching between colour and black & white does not take place correctly. In this event, press the [COLOUR START] key or the [BLACK & WHITE START] key as appropriate to manually switch between colour and black & white.
- Copying takes place in black & white when the [BLACK & WHITE START] key is pressed, regardless of the colour mode setting.



### System Settings (Administrator): Initial Status Settings (Colour Mode)

This is used to change the default colour mode setting.

### System Settings (Administrator): Detect Standard in Auto Colour Mode

When the colour mode is set to auto, the discrimination point for detecting whether originals are colour or black and white can be set to one of 5 levels.

# CHANGING THE EXPOSURE AND ORIGINAL IMAGE TYPE

The exposure and original image type can be selected to obtain a clear copy.

## AUTOMATIC ADJUSTMENT OF THE EXPOSURE AND ORIGINAL TYPE

Automatic exposure adjustment operates by default to automatically adjust the exposure level and original type as appropriate for the original being copied. ("Auto" is displayed.)

This function automatically adjusts the image during black & white copying and full colour copying to obtain the most suitable copy.

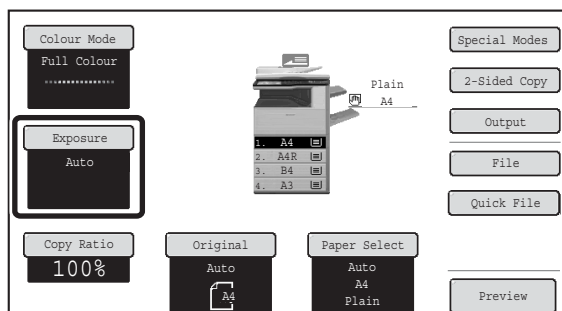

## SELECTING THE ORIGINAL TYPE AND MANUALLY ADJUSTING THE EXPOSURE

If you wish to select the original type or manually adjust the exposure, touch the [Exposure] key in the base screen of copy mode and follow the steps below.

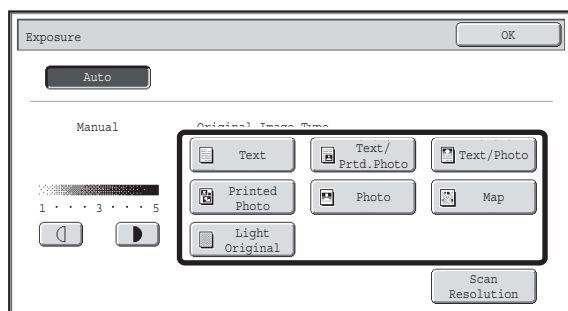

### Select the original image type.

Touch the appropriate original image type key for the original.

1

### ● Original image type select keys

Mode	Description
Text	Use this mode for regular text documents.
Text/Prt. Photo	This mode provides the best balance for copying an original which contains both text and printed photographs, such as a magazine or catalogue.
Text/Photo	This mode provides the best balance for copying an original which contains both text and photographs, such as a text document with a photo pasted on.
Printed photo	This mode is best for copying printed photographs, such as photos in a magazine or catalogue.
Photo	Use this mode to copy photos.
Map	This mode is best for copying the light colour shading and fine text found on most maps.
Light Original	Use this mode for originals with light pencil writing.

2

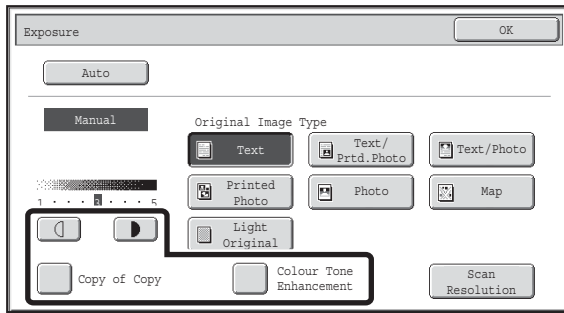

## Adjust the exposure level.

Touch the  key to make the copy darker.

Touch the  key to make the copy lighter.

### • Using a copy or printed page as an original

When using a copy or printed page from the machine as an original, touch the [Copy of Copy] checkbox so that a checkmark  appears.

When [Copy of Copy] is selected, only the [Text], [Printed Photo], and [Text/Printed Photo] original image type keys can be selected.

### • To enhance the colour of a colour copy...

Touch the [Colour Tone Enhancement] checkbox so that a checkmark  appears.



### • Guidelines for the exposure level when [Text] is selected:

- 1 to 2: Dark originals such as a newspaper
- 3: Normal density originals
- 4 to 5: Originals written in pencil or light coloured text

### • Restrictions when Colour Tone Enhancement is selected

When "Colour Tone Enhancement" is selected, the following functions cannot be used:

- [Copy of Copy]
- [Auto] and [Light Original] cannot be selected for the original image type.
- [Intensity] (in the special modes)

3

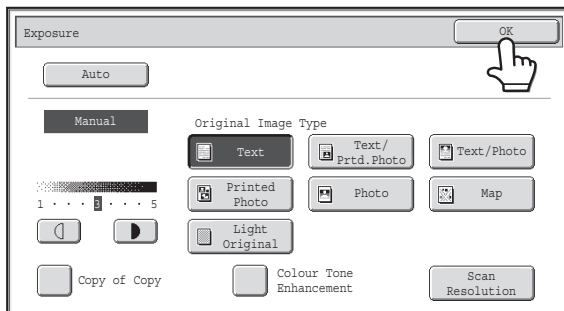

## Touch the [OK] key.



### • If [Auto] is selected but the darkness or lightness of the image does not seem quite right...

If the image seems too light or too dark when [Auto] is selected, the exposure level can be adjusted using "Copy Exposure Adjustment" in the system settings (administrator).

### • To change the resolution...

When making a full-size black & white copy, you can press the [Scan Resolution] key to select the scanning resolution. Numbers that can be selected for the document glass are different from numbers that can be selected for the automatic document feeder.



### • System Settings (Administrator): Initial Status Settings (Exposure Type)

This is used to change the default original image type.

### • System Settings (Administrator): Copy Exposure Adjustment

The exposure level used for automatic exposure adjustment can be adjusted.

### • System Settings (Administrator): B/W 600dpi x 600dpi Scanning Mode for Document Feeder / B/W Quick Scan from Document Glass

The default resolution setting can be changed.



# REDUCTION/ENLARGEMENT/ZOOM

## AUTOMATIC RATIO SELECTION (Auto Image)



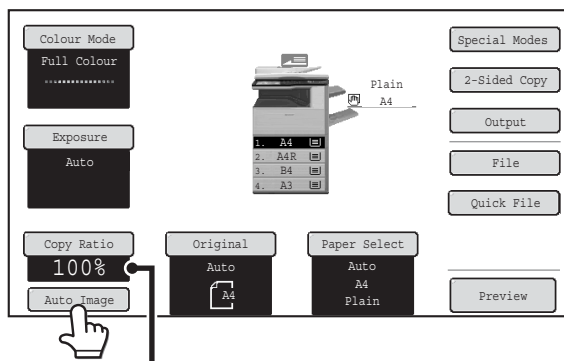

This section explains the automatic ratio selection function (Auto Image), which automatically selects the ratio to match the paper size.

When the paper tray is manually changed, the [Auto Image] key appears in the base screen of copy mode. Touch the [Auto Image] key to have the reduction or enlargement ratio automatically selected based on the original size and the selected paper size.

First place the original and select the paper tray, and then touch the [Auto Image] key.

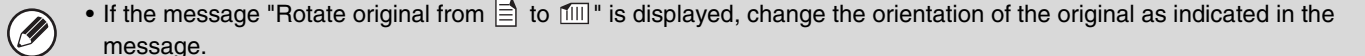

The selected ratio will appear in the ratio display.

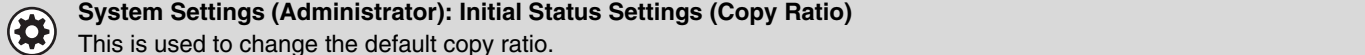

- 
  - If the message "Rotate original from  to  " is displayed, change the orientation of the original as indicated in the message.
  - For a non-standard size original, the size must be entered in order to use Auto Image.
- 
  - **To cancel automatic ratio selection...**  
Touch the [Auto Image] key so that it is no longer highlighted.
  - **To return the ratio to 100%...**  
To return the ratio setting to 100%, touch the [Copy Ratio] key to display the ratio menu and then touch the [100%] key.
- 
  - **System Settings (Administrator): Initial Status Settings (Copy Ratio)**  
This is used to change the default copy ratio.

# MANUALLY SELECTING THE RATIO (Preset ratios/Zoom)

Touch the [Copy Ratio] key in the base screen of copy mode to select one of five preset enlargement ratios or five (four) preset reduction ratios (maximum 400%, minimum 25%).

In addition, the zoom keys can be used to select any ratio from 25% to 400% in increments of 1%.

## Set the ratio.

Touch a preset ratio key and/or the zoom keys to set the ratio. There are two setting screens. Use the   keys to switch between the screens.

### ● 1st screen

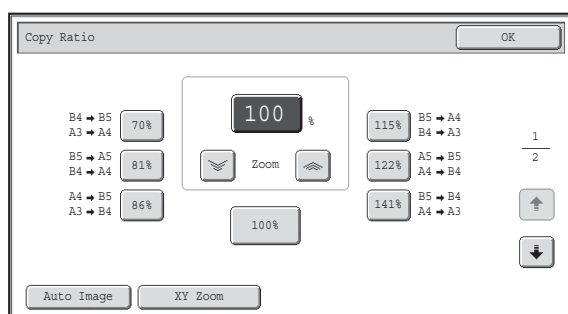

- Enlargement keys:
  - 115%, 122% and 141% (for the AB system).
  - 121% and 129% (for the inch system).
- Reduction keys:
  - 70%, 81% and 86% (for the AB system).
  - 64% and 77% (for the inch system).
- [100%] key

### ● 2nd screen

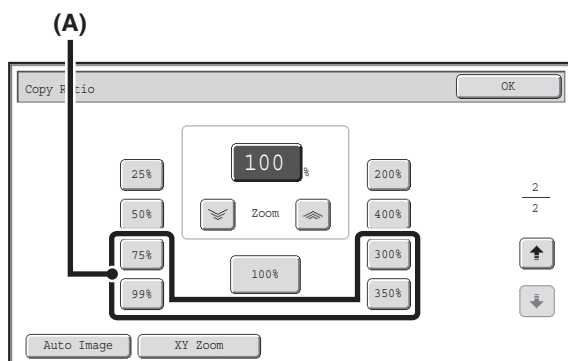







- Enlargement keys (2 to 4 ratios)
  - 200%, 400%, any ratio (max. of two)
- Reduction keys (2 to 4 ratios)
  - 25%, 50%, any ratio (max. of two)
- [100%] key



#### • (A) keys

The keys marked (A) can be set to show any ratio using "Add or Change Extra Preset Ratios" in the system settings (administrator).

- To quickly select a ratio, touch a reduction or enlargement key to select a ratio close to the desired ratio and then use the zoom keys for fine adjustment.
- The zoom keys can be used to select any ratio from 25% to 400% in increments of 1%. Touch the  key to increase the ratio, or the  key to decrease the ratio. (If you continue to touch the / key, the ratio will change automatically. After 3 seconds, the ratio will change rapidly.)
- As an alternative to touching the   keys, you can also directly touch the numeric value display key and change the value with the numeric keys.
- If the message "Image is larger than the copy paper." appears when an enlargement ratio is selected, the image may not fit on the paper.

2

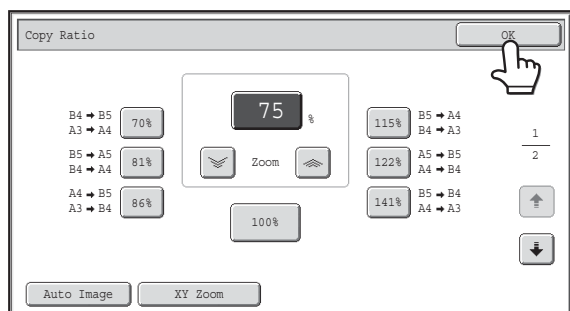

### Touch the [OK] key.

After touching the [OK] key, make sure that a paper size suitable for the ratio is selected.



When the automatic document feeder is used, the selectable ratio ranges from 25% to 200%.



#### To return the ratio to 100%...

To return the ratio setting to 100%, touch the [Copy Ratio] key to display the ratio menu and then touch the [100%] key.



#### System Settings (Administrator): Add or Change Extra Preset Ratios

Two enlargement preset ratios (101% to 400%) and two reduction preset ratios (25% to 99%) can be added. An added preset ratio can also be changed.

# ENLARGING/REDUCING THE LENGTH AND WIDTH SEPARATELY (XY Zoom)

The XY Zoom feature allows the horizontal and vertical copy ratios to be changed separately. Both the horizontal and vertical ratios can be set from 25% to 400% in increments of 1%. Touch the [Copy Ratio] key in the base screen of copy mode and then follow the steps below.

**When 50% is selected for the horizontal ratio and 70% is selected for the vertical ratio**

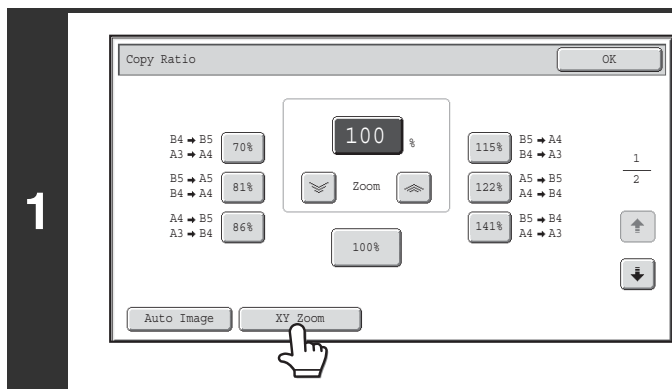
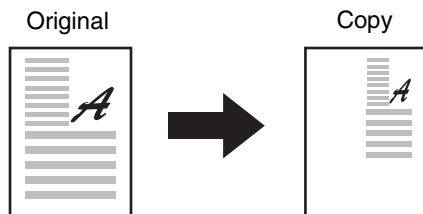

Touch the [XY Zoom] key.

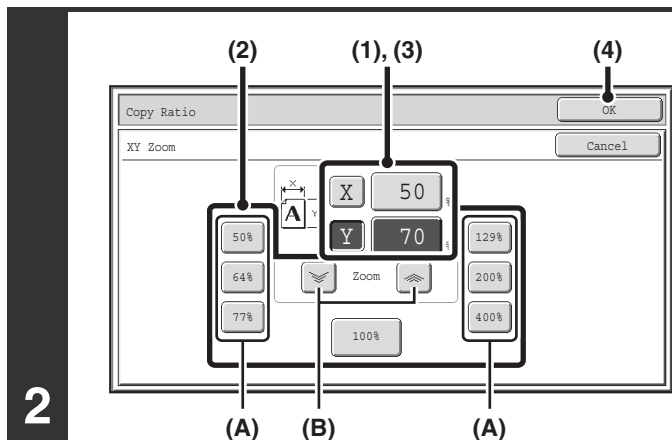

**Set the horizontal and vertical ratios.**

- (1) **Touch the [X] key.**  
The [X] key will be highlighted and the horizontal ratio can be set.
- (2) **Touch one of the preset ratio keys (A) and the zoom keys (B) to set the X (horizontal) ratio.**  
(A) A touched preset ratio key will not be highlighted.  
(B) The zoom keys can be touched to set the ratio from 25% to 400% in increments of 1%.
- (3) **Touch the [Y] key and set the Y (vertical) ratio in the same way as the [X] key.**
- (4) **Touch the [OK] key.**  
After touching the [OK] key, make sure that a paper size suitable for the ratio is selected.

- To quickly select a ratio, touch a preset ratio key (A) to select a ratio close to the desired ratio and then use the zoom keys (B) for fine adjustment.
- As an alternative to touching the keys, you can also directly touch the numeric value display key and change the value with the numeric keys.

When the automatic document feeder is used, the vertical and horizontal ratio selection ranges are both 25% to 200%.

**To cancel an XY zoom setting...**  
To cancel an XY Zoom setting, touch the [XY Zoom] key or the [Cancel] key.

# ORIGINAL SIZES

## SPECIFYING THE ORIGINAL SIZE

When the original size is a non-standard size or is not detected correctly, manually specify the original size. Touch the [Original] key in the base screen of copy mode and then follow the steps below.

### Specifying an AB original size

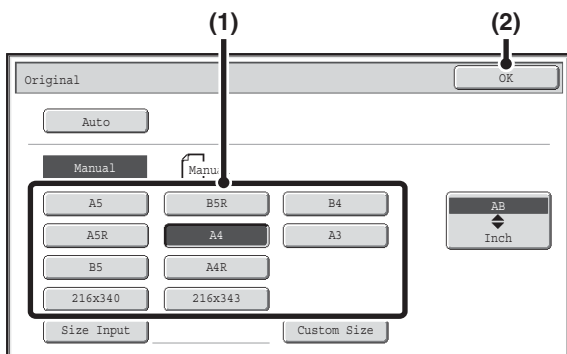

- (1) Touch the appropriate original size key.
- (2) Touch the [OK] key.

### Specifying an inch original size

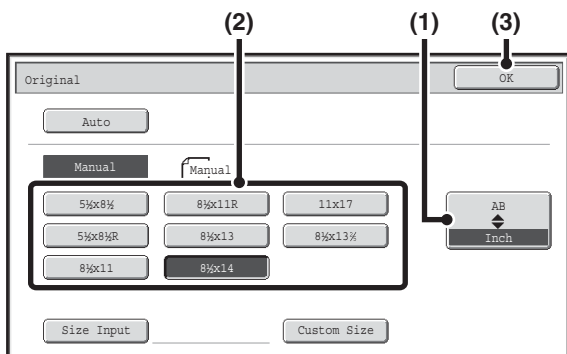

- (1) Touch the [AB  $\blacktriangle$  Inch] key.
- (2) Touch the appropriate original size key.
- (3) Touch the [OK] key.

### Specifying a non-standard original size

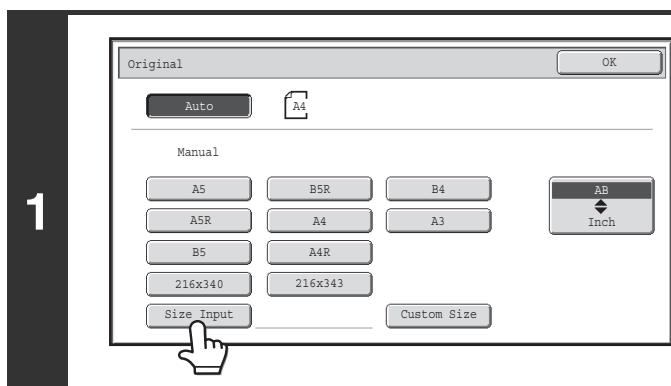

Touch the [Size Input] key.

1

2

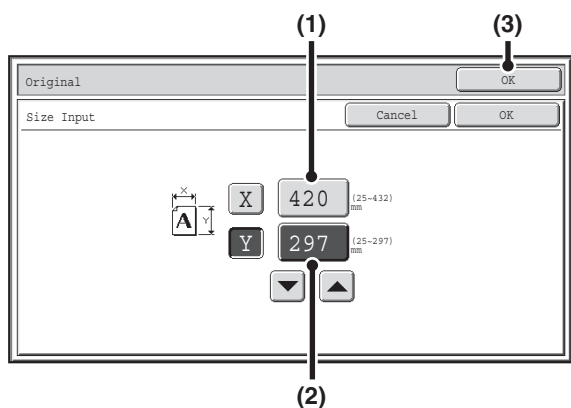

**Enter the original size.**

**(1) Enter the X (horizontal) dimension of the original.**

Touch the X (width) numeric value display key to open a number entry screen. Enter the width of the original with the numeric keys, and touch the [OK] key in the number entry screen. When the document glass is used, a number from 25 mm to 432 mm (1" to 17") can be entered.

When the automatic document feeder is used, a number from 140 mm to 432 mm (5-1/2" to 17") can be entered. If the horizontal dimension of the original is less than 140 mm (5-1/2"), use the document glass.

**(2) Enter the Y (vertical) dimension of the original.**

Touch the Y (height) numeric value display key to open a number entry screen. Enter the height of the original with the numeric keys, and touch the [OK] key in the number entry screen. When the document glass is used, a number from 25 mm to 297 mm (1" to 11-5/8") can be entered. When the automatic document feeder is used, a number from 131 mm to 297 mm (5-1/8" to 11-5/8") can be entered. If the vertical dimension of the original is less than 131 mm (5-1/8"), use the document glass.

**(3) Touch the [OK] key.**

You will return to the base screen. Make sure that the entered dimensions appear in the [Original] key.

You can also touch the keys to change the number.

**STORING FREQUENTLY USED ORIGINAL SIZES**

You can save special original sizes that you frequently use. This section explains how to store, retrieve, change, and delete special original sizes.

**Storing original sizes (editing/clearing)**

Up to 12 special original sizes can be stored.

Touch the [Original] key in the base screen of copy mode and then follow the steps below.

1

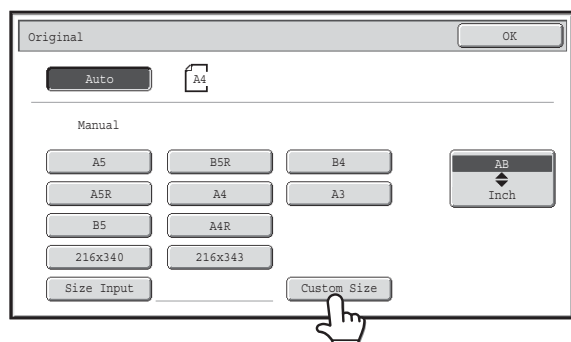

**Touch the [Custom Size] key.**

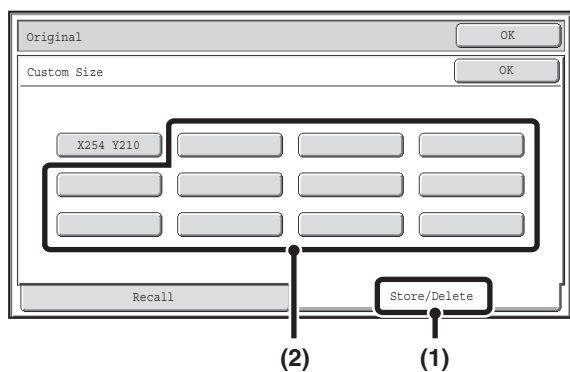

### Store the original size.

- (1) Touch the [Store/Delete] tab.
- (2) Touch a key for storing a custom original size.

Touch a key that does not show a size (  ).

2



#### If you wish to edit or clear a previously stored key...

Touch the key that you want to edit or clear. The following screen will appear.



- To edit the key, touch the [Amend] key and go to the next step.
- To clear the key, touch the [Delete] key. Make sure that the original size has been cleared and touch the [OK] key.

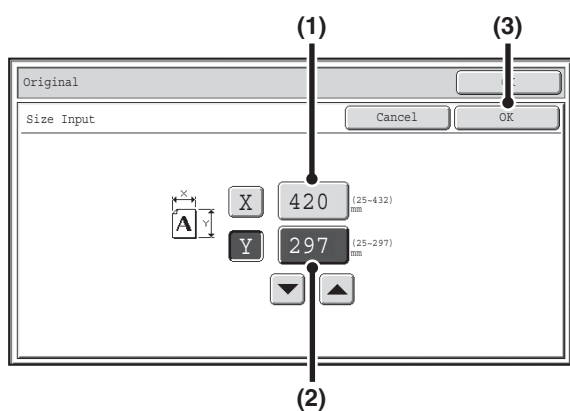

### Enter the original size.

- (1) Enter the X (horizontal) dimension of the original.

Touch the X (width) numeric value display key to open a number entry screen. Enter the width of the original with the numeric keys, and touch the [OK] key in the number entry screen. A dimension from 25 mm to 432 mm (1" to 17") can be entered.

- (2) Enter the Y (vertical) dimension of the original.

Touch the Y (height) numeric value display key to open a number entry screen. Enter the height of the original with the numeric keys, and touch the [OK] key in the number entry screen. A dimension from 25 mm to 297 mm (1" to 11-5/8") can be entered.

- (3) Touch the [OK] key.

3



You can also touch the   keys to change the number.



The stored original size will be retained even if the main power is turned off.



#### To cancel the operation...

Press the [CLEAR ALL] key (  ).

## Retrieving a stored original size

To retrieve a stored original size, touch the [Original] key in the base screen of copy mode and perform the steps below.

1

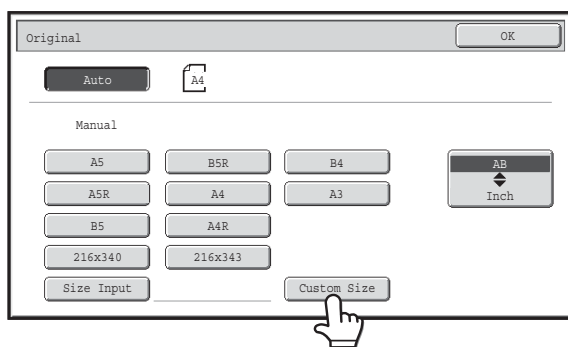

Touch the [Custom Size] key.

2

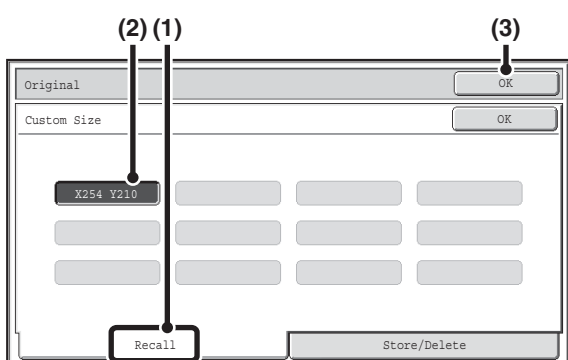

Retrieve the desired stored original size.

- (1) Touch the [Recall] tab.
- (2) Touch the key of the original size that you wish to retrieve.
- (3) Touch the [OK] key.



To cancel the operation...

Press the [CLEAR ALL] key (CA).



# OUTPUT

To select output functions and the output tray, touch the [Output] key in the base screen of copy mode. Output functions that can be selected are sort, group, offset, staple sort, and punch. All explanations of the settings below assume that a finisher and punch module are installed.

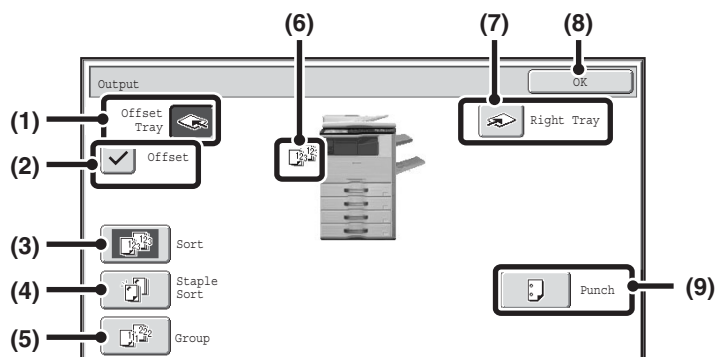

**(1) [Offset Tray] key ([Centre Tray] key\*)**

Output is delivered to the offset tray. The [Offset Tray] key is automatically selected when the [Staple Sort] key is selected.

\* When a finisher is not installed, this key is the [Centre Tray] key.

**(2) [Offset] key**

This is used to offset each set of output from the previous set.

The offset function operates when the checkbox is selected  and does not operate when the checkbox is not selected . (The offset checkmark is automatically cleared when the staple sort function is selected.)

[Offset function](#) (page 2-35)

**(3) [Sort] key**

This is used to sort (collate) output into sets.

[Sort mode](#) (page 2-35)

**(4) [Staple Sort] key**

This is used to sort output into sets, staple each set, and deliver the sets to the tray. (Note that the sets will not be offset in the output tray.) When this function is selected, three keys will appear for selecting the staple position.

[Staple sort function](#) (page 2-36)

**(5) [Group] key**

This is used to group copies by page.

[Group mode](#) (page 2-35)

**(6) Output display**

An icon will appear to indicate the output mode.

**(7) [Right Tray] key**

Select this key to have output delivered to the right tray. When the right tray is selected, offset, staple sort, and punch cannot be selected.

**(8) [OK] key**

Touch this key to close the output screen and return to the base screen.

**(9) [Punch] key**

This is used to punch holes in the output.

[Punch function](#) (page 2-37)



The above screen shows the keys that appear when a finisher and punch module are installed. The keys that appear will vary depending on what peripheral devices are installed.

In addition, it may not be possible to select some keys depending what peripheral devices are installed. If your screen is different from the screen of previous page, see the screens that follow.

**Example**

The screen when a finisher is not installed.



# OUTPUT MODES

This section explains the output modes.

## Sort mode

This is used to sort (collate) output into sets.

**Example: Sorting the output into 5 sets**

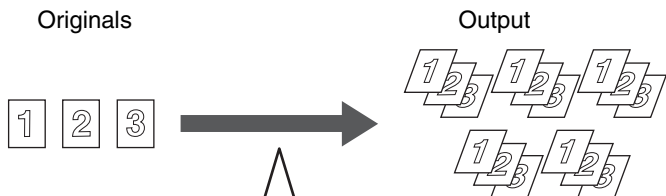

1 2 3  
4 5 6  
7 8 9  
\* 0 #/P

Set the number of copies (5).

↓

Output

Touch the [Output] key.

↓

Sort

Touch the [Sort] key.

↓

Press the [COLOUR START] key or the [BLACK & WHITE START] key.

- The sort function is automatically selected when originals are placed in the automatic document feeder.
- When the Quick File Folder for document filing is full, copying of a large number of originals using the sort function will be impeded. Delete unneeded files from the Quick File Folder.

## Group mode

This function groups copies by page.

**Example: Groups of 5 copies of each page**

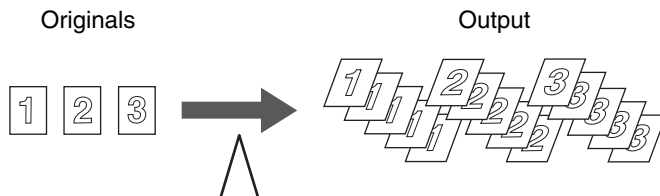

1 2 3  
4 5 6  
7 8 9  
\* 0 #/P

Set the number of copies (5).

↓

Output

Touch the [Output] key.

↓

Group

Touch the [Group] key.

↓

Press the [COLOUR START] key or the [BLACK & WHITE START] key.

- The group function is automatically selected when an original is placed on the document glass.

## Offset function

This function offsets each set of copies from the previous set in the output tray, making it easy to separate sets of copies.

Offset function "ON"

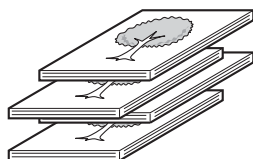

Offset function "OFF"

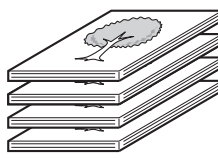

- The offset function cannot be used in the right tray.
- The offset function cannot be selected when the staple sort function is selected.

## Staple sort function





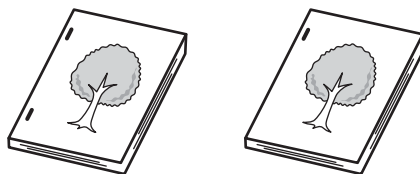

The staple sort function sorts output into sets, staples each set, and delivers the sets to the tray.

The relations between the stapling positions, paper orientation, permitted paper sizes for stapling, and number of sheets that can be stapled are shown below.

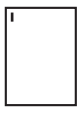
For original placement orientations, see "[Original placement orientation \(for the staple sort and punch functions\)](#)" (page 2-37).

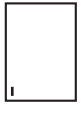

Staple sort

Stapling positions	Vertically-oriented paper	Horizontally-oriented paper
1 staple at top left corner 		
1 staple at bottom left corner 		
2 staples at left edge 		

**Applicable paper sizes**  
 A4, B5, 8-1/2" x 11", 16K  
**Number of sheets that can be stapled:**  
 Max. 50 sheets\*

• **Finisher**  
**Applicable paper sizes**  
 A3, B4, A4R, 11" x 17", 8-1/2" x 14",  
 8-1/2" x 13-1/2", 8-1/2" x 13-2/5",  
 8-1/2" x 13", 8-1/2" x 11"R, 8K, 16KR  
**Number of sheets that can be stapled**  
 A3, B4, 11" x 17", 8-1/2" x 14",  
 8-1/2" x 13-1/2", 8-1/2" x 13-2/5",  
 8-1/2" x 13", 8K:  
 Max. 30 sheets\*  
 A4R, 8-1/2" x 11"R, 16KR:  
 Max. 50 sheets\*

\* You can insert 2 sheets of maximum 256g/m<sup>2</sup> as cover sheets and staple them. In such cases, you can subtract 2 from the maximum number of sheets that can be stapled and use those many sheets.

- The number of sheets that can be stapled at once includes any covers and/or inserts that are inserted.
- When Mixed Size Original in the special modes is used with the "Same Width" setting, the maximum number of sheets that can be stapled is 30 for a finisher regardless of the paper size.

## Punch function

If an optional punch module is installed, holes can be punched in output.

Paper size that can be punched is B5R to A3 (7-1/4" x 10-1/2"R to 11" x 17"). However, A3W (12" x 18") sized paper and special media such as transparency film and tab paper cannot be used.

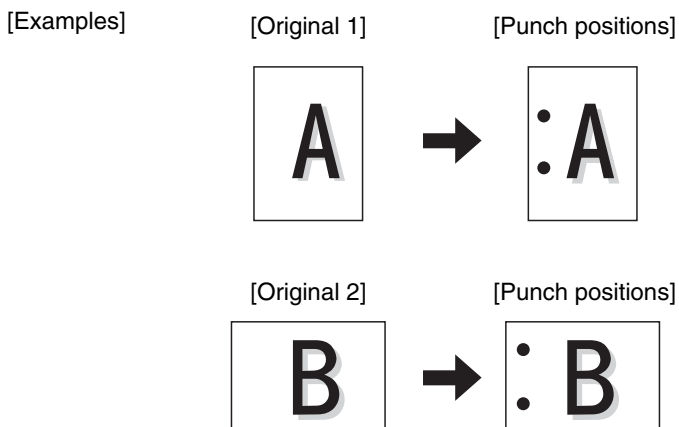

## Original placement orientation (for the staple sort and punch functions)

When using the staple sort function or the punch function, the original must be placed as shown below to enable stapling or punching in the desired position on the paper.

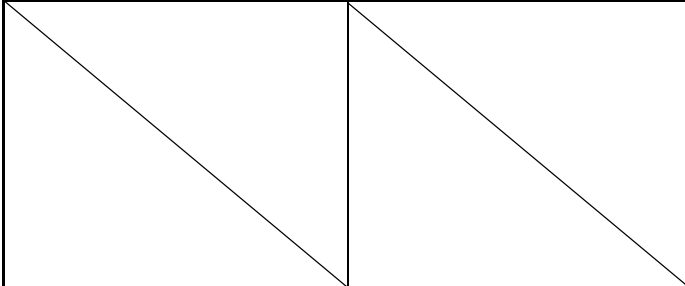
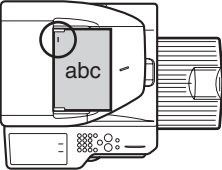
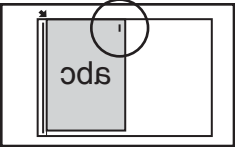
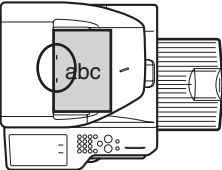
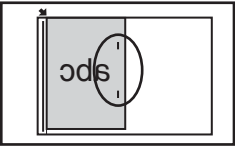
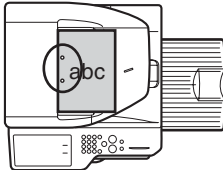
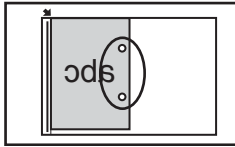
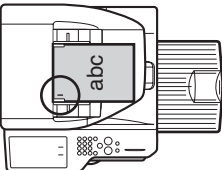
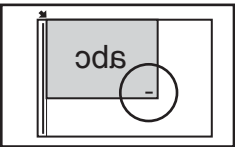
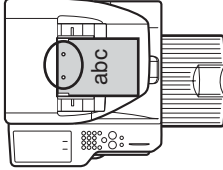
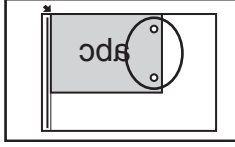
Staple sort		Punch			
Document feeder tray	Document glass	Document feeder tray	Document glass		
<b>One staple (top)</b>					
					
<b>Two staples</b>					
					
<b>One staple (bottom)</b>					

# MAKING COPIES USING THE BYPASS TRAY

In addition to plain paper, the bypass tray allows you to make copies on transparency film, envelopes, tab paper, and other special media.

For detailed information on paper that can be loaded in the bypass tray, see "[IMPORTANT POINTS ABOUT PAPER](#)" (page 1-27) in "1. BEFORE USING THE MACHINE". For precautions when loading paper in the bypass tray, see "[LOADING PAPER IN THE BYPASS TRAY](#)" (page 1-35) in "1. BEFORE USING THE MACHINE".

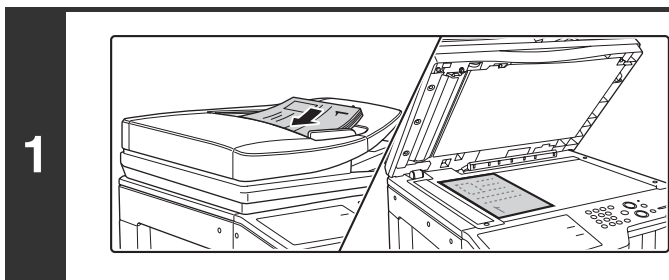

## Place the original.

Place the original face up in the document feeder tray, or face down on the document glass.

### When placing the originals on the document glass...

After placing the original, be sure to close the automatic document feeder. If left open, parts outside of the original will be copied black, causing excessive use of toner.

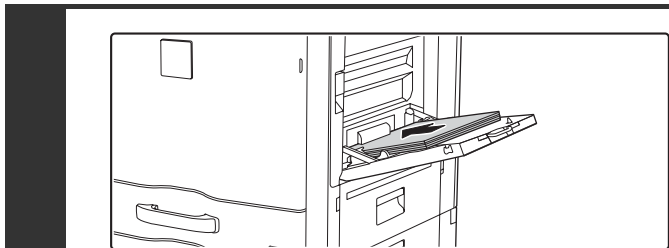

## Place paper in the bypass tray.

Insert the paper with print side face down. However, if the paper type is "Letter Head" or "Pre-Printed", load the paper with the print side face up\*.

\* If "Disabling of Duplex" is enabled in the system settings (administrator), load the paper in the normal way (face up in trays 1 to 5; face down in the bypass tray).

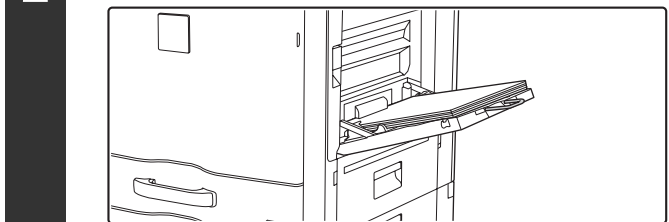

When loading a large sheet of paper, be sure to pull out the bypass tray extension. Pull the bypass tray extension all the way out. If the bypass tray extension is not pulled all the way out, the size of the loaded paper will not be correctly displayed.

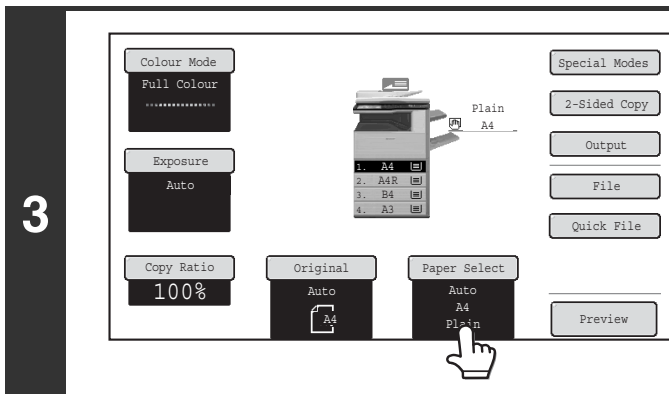

## Touch the [Paper Select] key.

4

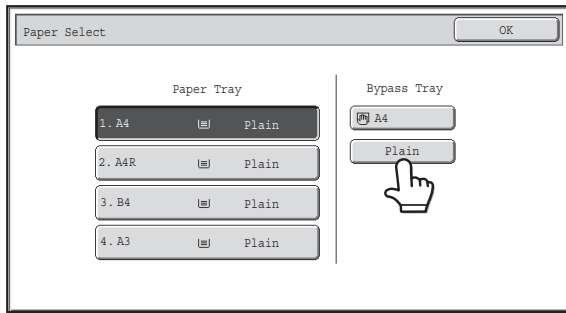

**Check the paper type setting for the bypass tray. If you need to change the setting, touch the paper type key.**

If you do not need to change the paper size and type that appear under "Bypass Tray", go to step 7.

5

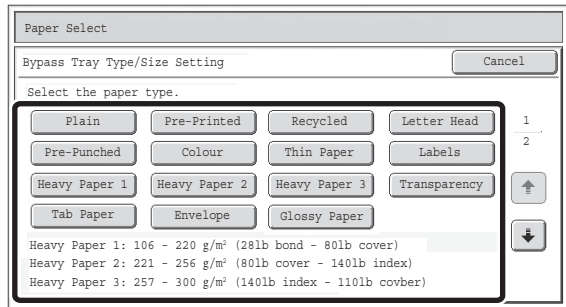

**Select the type of paper used in the bypass tray.**

Select the paper type that you will use.

6

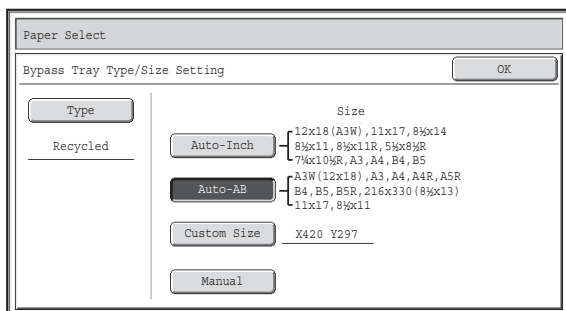

**Set the paper size.**

**(1) Select the paper size.**

**[Auto-Inch] key**

When the paper placed in the bypass tray is an inch size (8-1/2" x 11", etc.), the paper size will be detected automatically and an appropriate size set.

**[Auto-AB] key**

When the paper inserted in the bypass tray is an AB size (A4, etc.), the paper size will be detected automatically and an appropriate size set.

**[Custom Size] key**

Touch this key if you wish to enter numeric values for the size of the loaded paper.

[Enter the paper size of the bypass tray](#) (page 2-40)

**[Manual] key**

This key can be touched to display the [16K], [16KR], and [8K] keys. Touch one of these keys if you loaded the corresponding size of paper.

**(2) Touch the [OK] key.**



- When [Envelope] is selected, specify the size of the envelope. When finished, touch the [OK] key.
- If tab paper is selected, check the size. Touch the [Auto-Inch] key or the [Auto-AB] key. When you have finished checking/changing the setting, touch the [OK] key.

7

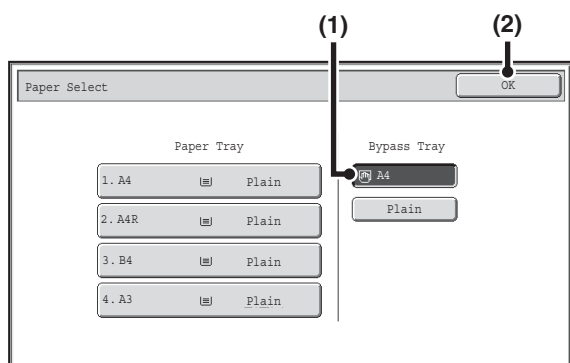

**Select the bypass tray.**

- (1) Touch the paper size key of the bypass tray.
- (2) Touch the [OK] key.

8

**Press the [COLOUR START] key or the [BLACK & WHITE START] key.**

Scanning begins.

- If the originals were placed in the document feeder tray, the originals are copied.
  - If you placed the originals on the document glass, scan each page one page at a time.
- When using sort mode, change originals and press the [START] key. Repeat until all pages have been scanned and then press the [Read-End] key. (For the second original and following originals, use the same [START] key as you did for the first original.

 **To cancel scanning of the original and copying...**  
Press the [STOP] key (  ).

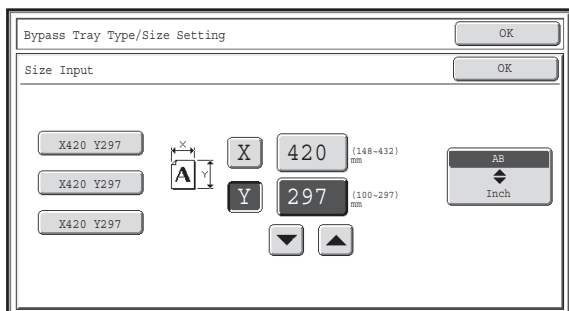

**Enter the paper size of the bypass tray**

When the [Custom Size] key is touched, the paper size entry screen appears.



Touch the X (width) numeric value display key to open a number entry screen. Enter the width of the paper with the numeric keys, and touch the [OK] key in the number entry screen.

Touch the Y (height) numeric value display key to open a number entry screen. Enter the height of the paper with the numeric keys, and touch the [OK] key in the number entry screen.



-  You can also touch the   keys to change the number.
- Stored custom paper sizes appear in the keys on the left side of the screen. Custom paper sizes are stored in the system settings. For details, see "[Paper Tray Settings](#)" (page 7-13) in "7. SYSTEM SETTINGS". If the key for the size that you wish to enter appears, touch that key.



# SPECIAL MODES

This chapter explains Margin Shift, Erase, Dual Page Copy, and other special modes.

## SPECIAL MODES

When the [Special Modes] key is pressed in the base screen, the special modes menu screen appears. The special modes menu consists of two screens. Touch the   keys to move between the screens. After selecting special mode settings, touch the [OK] key in the special modes menu screen to complete the settings and return to the base screen of copy mode.

### Special modes menu (1st screen)

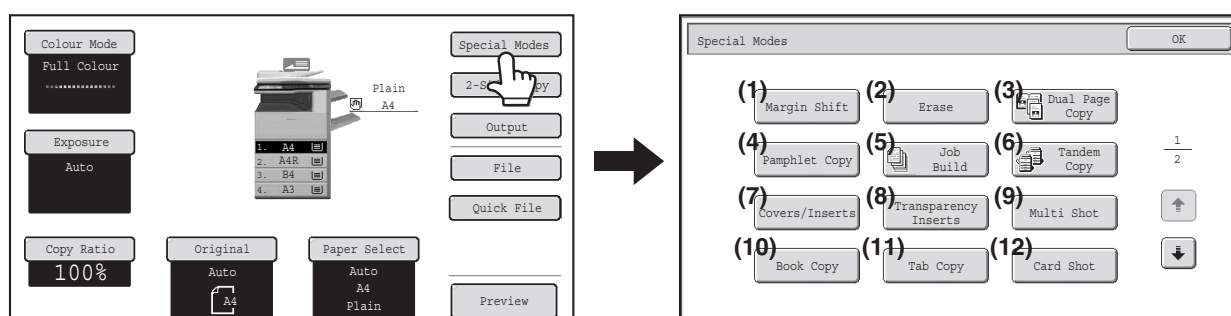

- (1) **[Margin Shift] key**  
 [ADDING MARGINS \(Margin Shift\)](#) (page 2-44)
- (2) **[Erase] key**  
 [ERASING PERIPHERAL SHADOWS \(Erase\)](#) (page 2-46)
- (3) **[Dual Page Copy] key**  
 [COPYING EACH FACING PAGE OF A BOUND DOCUMENT \(Dual Page Copy\)](#) (page 2-48)
- (4) **[Pamphlet Copy] key**  
 [MAKING COPIES IN PAMPHLET FORMAT \(Pamphlet Copy\)](#) (page 2-50)
- (5) **[Job Build] key**  
 [COPYING A LARGE NUMBER OF ORIGINALS AT ONCE \(Job Build\)](#) (page 2-53)
- (6) **[Tandem Copy] key\***  
 [USING TWO MACHINES TO MAKE A LARGE NUMBER OF COPIES \(Tandem Copy\)](#) (page 2-56)  
 \* On the MX-2314N, the productivity kit is required.
- (7) **[Covers/Inserts] key**  
 [USING A DIFFERENT PAPER TYPE FOR COVERS \(Covers/Inserts\)](#) (page 2-59)
- (8) **[Transparency Inserts] key**  
 [ADDING INSERTS WHEN COPYING ON TRANSPARENCY FILM \(Transparency Inserts\)](#) (page 2-70)
- (9) **[Multi Shot] key**  
 [COPYING MULTIPLE ORIGINALS ONTO ONE SHEET \(Multi Shot\)](#) (page 2-72)
- (10) **[Book Copy] key**  
 [COPYING A PAMPHLET \(Book Copy\)](#) (page 2-74)
- (11) **[Tab Copy] key**  
 [COPYING CAPTIONS ONTO TAB PAPER \(Tab Copy\)](#) (page 2-78)
- (12) **[Card Shot] key**  
 [COPYING BOTH SIDES OF A CARD ON ONE SHEET OF PAPER \(Card Shot\)](#) (page 2-81)

## Special modes menu (2nd screen)

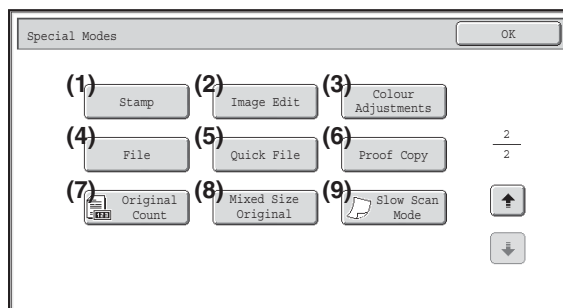

- |   |   |
|---|---|
| <p>(1) <b>[Stamp] key</b><br/> <a href="#">PRINTING THE DATE AND A STAMP ON COPIES (Stamp)</a> (page 2-84)</p> <p>(2) <b>[Image Edit] key</b><br/> <a href="#">[Image Edit] KEY</a> (page 2-104)</p> <p>(3) <b>[Colour Adjustments] key</b><br/> <a href="#">[Colour Adjustments] KEY</a> (page 2-115)</p> <p>(4) <b>[File] key*</b><br/>           This saves a job in a folder of the document filing function.</p> <p>(5) <b>[Quick File] key*</b><br/>           This saves a job in the Quick File folder of the document filing function.</p> | <p>(6) <b>[Proof Copy] key*</b><br/> <a href="#">CHECKING COPIES BEFORE PRINTING (Proof Copy)</a> (page 2-124)<br/>           The productivity kit is required.</p> <p>(7) <b>[Original Count] key</b><br/> <a href="#">CHECKING THE NUMBER OF SCANNED ORIGINAL SHEETS BEFORE COPYING (Original Count)</a> (page 2-127)</p> <p>(8) <b>[Mixed Size Original] key</b><br/> <a href="#">COPYING ORIGINALS OF DIFFERENT SIZES (Mixed Size Original)</a> (page 2-129)</p> <p>(9) <b>[Slow Scan Mode] key</b><br/> <a href="#">COPYING THIN ORIGINALS (Slow Scan Mode)</a> (page 2-132)</p> |
|---|---|

\* On the MX-2314N, the productivity kit is required.

- Special modes can generally be combined with other special modes, however, there are some combinations that are not possible. In this case, a message indicating that the combination is not possible will be displayed.
- The displayed menu will vary depending on the country and regions.

## [OK] key and [Cancel] key

In some cases two [OK] keys and one [Cancel] key will appear in the special mode screens. The keys are used as follows:

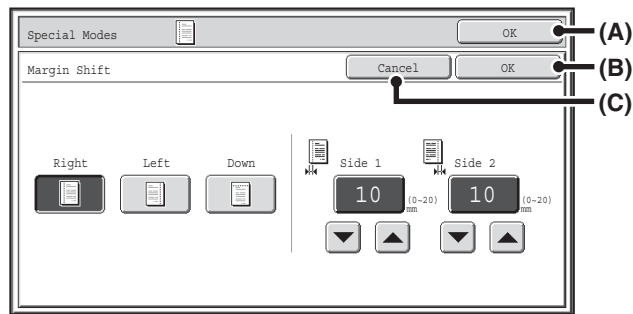

- (A) Enter the selected special mode settings and return to the base screen of copy mode.
- (B) Enter the selected special mode settings and return to the special modes menu screen. Touch this key when you wish to continue selecting other special mode settings.
- (C) During selection of special mode settings, this key returns you to the special modes menu screen without saving the settings. When settings have been completed, this cancels the settings and returns you to the special modes menu screen.

# ADDING MARGINS (Margin Shift)

This function is used to shift the copy image right, left or down to adjust the margin. This is convenient when you wish to bind the copies with a string or in a binder.

## Shifting the image to the right so the copies can be bound at the left edge with a string

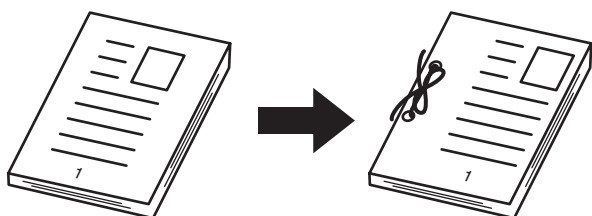

Not using margin shift	Using margin shift
<p>The punch holes cut off part of the image</p>	<p>The image is moved to allow space for the string holes so the image is not cut off.</p>

## Margin shift positions

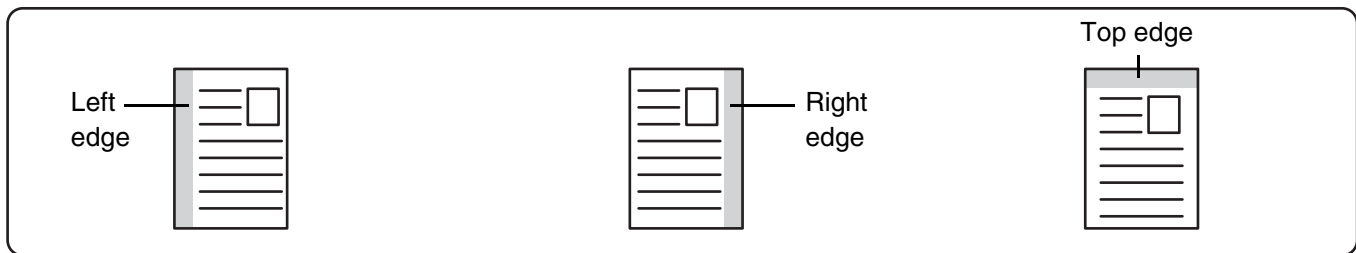

1

### Place the original.

Place the original face up in the document feeder tray, or face down on the document glass.

2

### Select the special modes.

(1) Touch the [Special Modes] key.

(2) Touch the [Margin Shift] key.

[Special modes menu \(1st screen\)](#) (page 2-41)

3

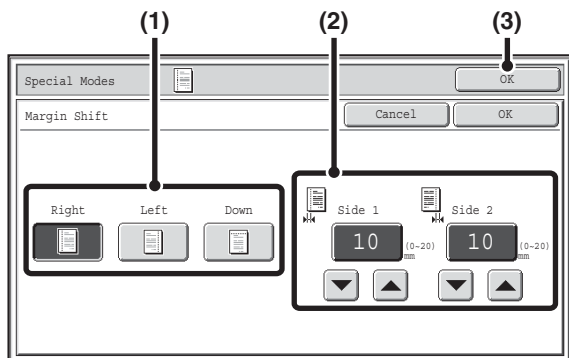

### Set the margin shift.

(1) Touch the margin shift position. Select one of the three positions.

(2) Set the amount of the margin shift with . 0 mm to 20 mm (0" to 1") can be entered.

(3) Touch the [OK] key. You will return to the base screen of copy mode.

4

**Press the [COLOUR START] key or the [BLACK & WHITE START] key.**

Copying will begin.

If you are using the document glass to copy multiple original pages, copying will take place as you scan each original. If you have selected sort mode, change originals and press the [START] key. Repeat until all pages have been scanned and then touch the [Read-End] key. (For the second original and following originals, use the same [START] key as you did for the first original.)

**To cancel scanning of the original and copying...**

Press the [STOP] key (⏹).



Rotation copy cannot be used in combination with margin shift.

**To cancel the margin shift setting...**

Touch the [Cancel] key in the screen of step 3.

**System Settings (Administrator): Initial Margin Shift Setting**

The default margin shift setting can be set from 0 mm to 20 mm (0" to 1"). The factory default setting is 10 mm (1/2").

# ERASING PERIPHERAL SHADOWS (Erase)

The erase function is used to erase shadows around the edges of copies that occur when copying thick originals or books.

When a thick book is copied

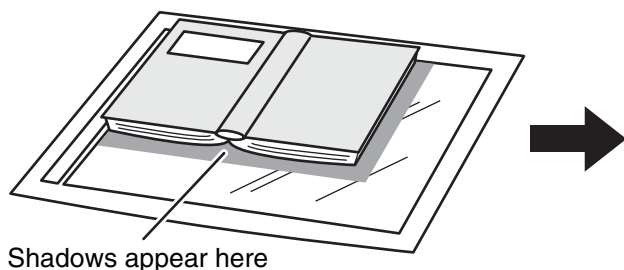

Not using the erase function	Using the erase function
<p>Shadows appear on the copy.</p>	<p>Shadows do not appear on the copy.</p>

Erase modes

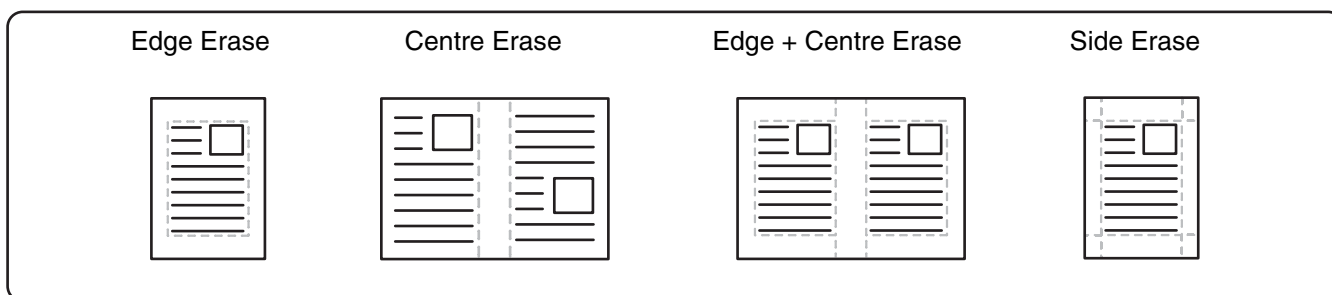

1

## Place the original.

Place the original face up in the document feeder tray, or face down on the document glass.

2

## Select the special modes.

- (1) Touch the [Special Modes] key.
- (2) Touch the [Erase] key.

[Special modes menu \(1st screen\)](#) (page 2-41)

3

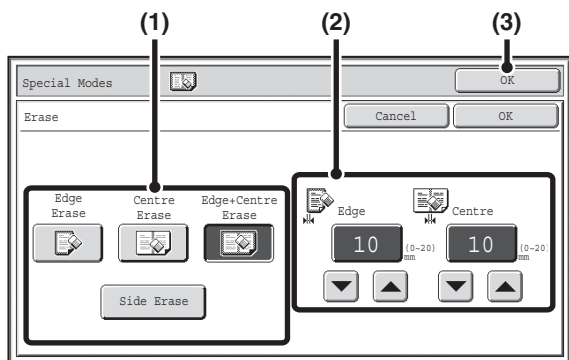

Select the erase settings.

(1) Touch the desired erase mode.

Select one of the four positions.  
Touch the [Side Erase] key to open the following screen.

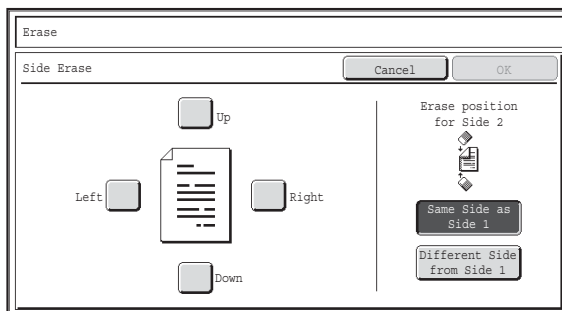

Touch the checkbox of the edge that you wish to erase and make sure that a checkmark appears.  
When performing 1-sided to 2-sided copying or 2-sided to 2-sided copying, set the erase edge on the reverse side.

- If you touch the [Same Side as Side 1] key, the edge in the same position as on the front side will be erased.
- If you touch the [Different Side from Side 1], the edge in the position opposite to the erased edge on the front side will be erased.

When you have completed the erase edge settings, touch the [OK] key.

(2) Set the erasure width with [▼] [▲].

0 mm to 20 mm (0" to 1") can be entered.

(3) Touch the [OK] key.

You will return to the base screen of copy mode.

4

Press the [COLOUR START] key or the [BLACK & WHITE START] key.

Copying will begin.

If you are using the document glass to copy multiple original pages, copying will take place as you scan each original. If you have selected sort mode, change originals and press the [START] key. Repeat until all pages have been scanned and then touch the [Read-End] key. (For the second original and following originals, use the same [START] key as you did for the first original.)

To cancel scanning of the original and copying...  
Press the [STOP] key ().

If a ratio setting is used in combination with an erase setting, the erase width will change according to the selected ratio. For example, if the erase width setting is 20 mm (1") and the image is reduced to 50%, the erase width will be 10 mm (1/2").

To cancel the erase setting...  
Touch the [Cancel] key in the screen of step 3.

System Settings (Administrator): Erase Width Adjustment  
The default erase width can be set from 0 mm to 20 mm (0" to 1"). The factory default setting is 10 mm (1/2").

# COPYING EACH FACING PAGE OF A BOUND DOCUMENT (Dual Page Copy)

The dual page copy function produces separate copies of two document pages that are placed side by side on the document glass. This function is useful when making copies of the facing pages of a book or other bound document.

## Copying the facing pages of a book or bound document

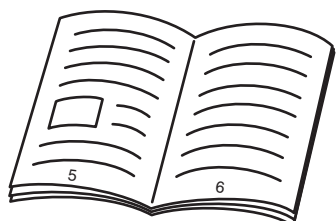

Book or bound document

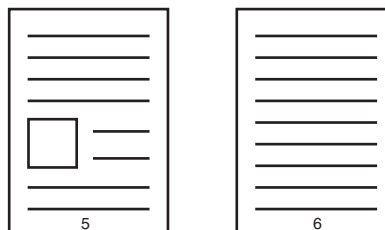

The facing pages are copied onto 2 separate pages.

1

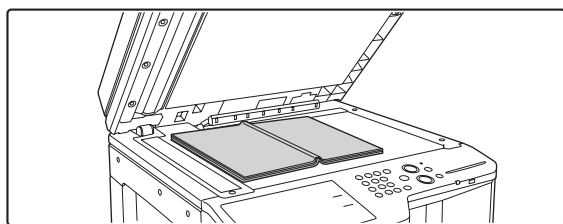

### Place the original on the document glass.

Align the centre of the original with the appropriate size mark ▼.

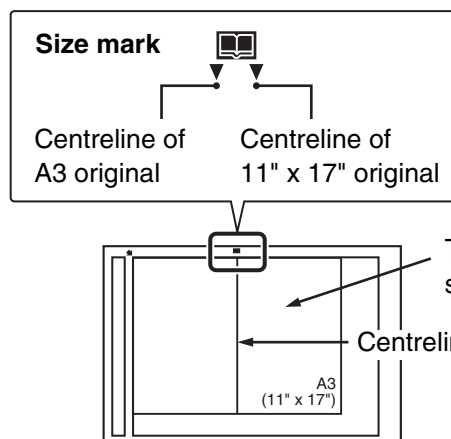

2

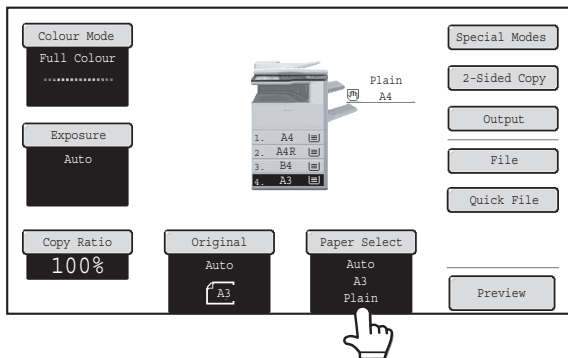

### Select A4 (8-1/2" x 11") size paper.

Select the paper as explained in "PAPER TRAYS" (page 2-11).



3

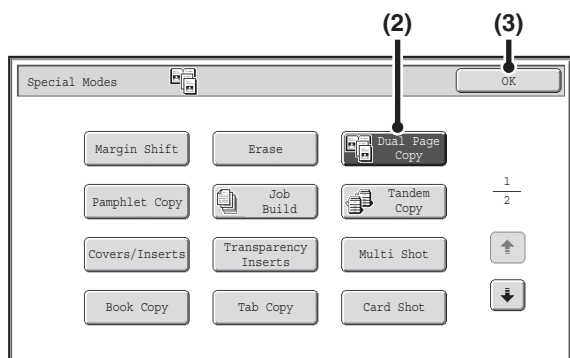

### Select Dual Page Copy.



- (1) Touch the [Special Modes] key.  
 ➔ [SPECIAL MODES](#) (page 2-41)
- (2) Touch the [Dual Page Copy] key so that it is highlighted.
- (3) Touch the [OK] key.  
 You will return to the base screen of copy mode.

4

### Press the [COLOUR START] key or the [BLACK & WHITE START] key.

Copying will begin.

If you have selected sort mode, change originals and press the [START] key. Repeat until all pages have been scanned and then touch the [Read-End] key. (For the second original and following originals, use the same [START] key as you did for the first original.)

-  **To cancel scanning of the original and copying...**  
 Press the [STOP] key (.



- When using dual page copy, the original must be placed on the document glass.
- To erase shadows caused by the binding of a book or other bound document, use the erase function. However, note that [Centre Erase] and [Edge + Centre Erase] cannot be used.



#### To cancel dual page copy...

Touch the [Dual Page Copy] key in the screen of step 3 so that it is not highlighted.

# MAKING COPIES IN PAMPHLET FORMAT (Pamphlet Copy)

This function copies 2 original pages onto the front side and 2 original pages onto the reverse side of each sheet of paper so that the copies can be folded at the centreline to form a pamphlet.

This function is convenient for arranging copies into an attractive booklet or pamphlet.

## Pamphlet copy using 8 original pages

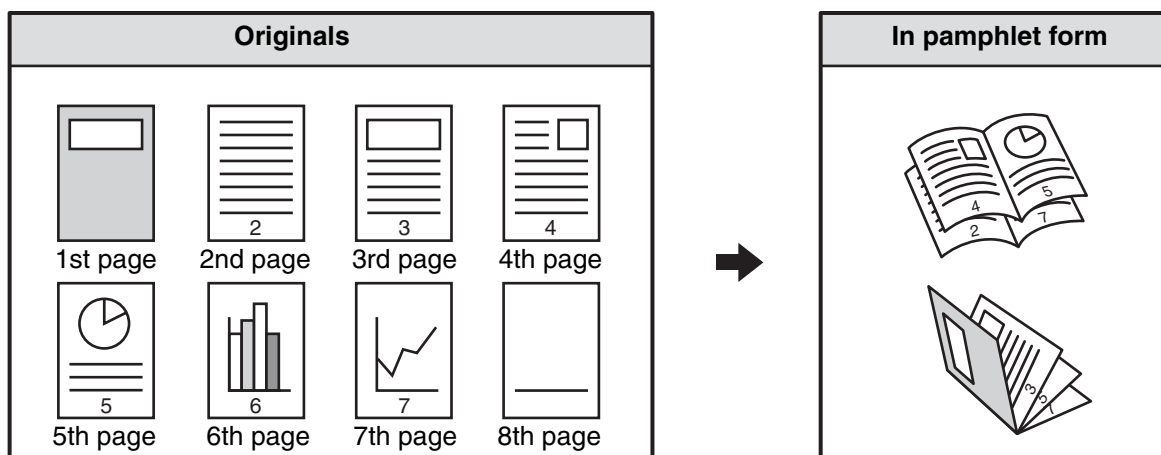

## Binding side

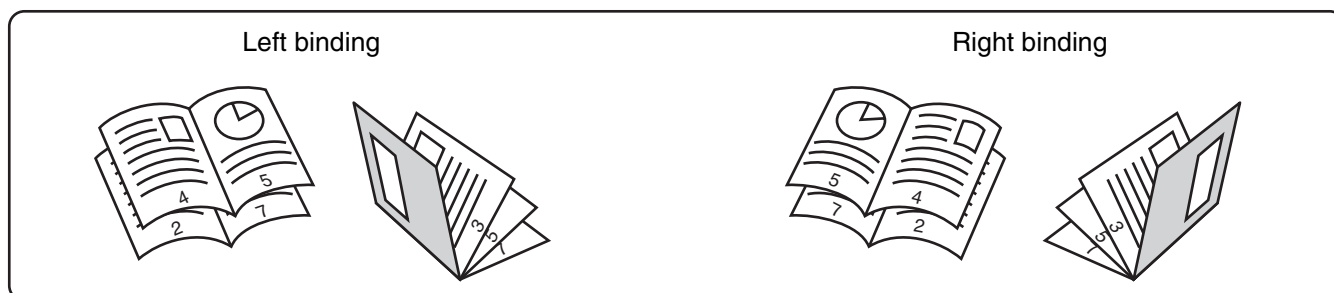

### 1 Place the original.

Place the original face up in the document feeder tray, or face down on the document glass.



If the originals are 2-sided, place them in the document feeder tray.

### 2 Select the special modes.

(1) Touch the [Special Modes] key.

(2) Touch the [Pamphlet Copy] key.

 [Special modes menu \(1st screen\)](#) (page 2-41)

3

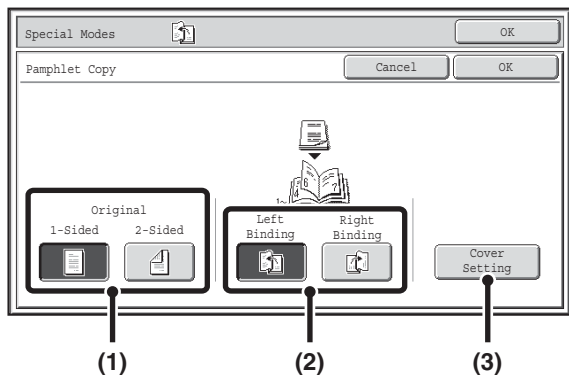

**Select pamphlet copy settings.**

- (1) If the original is 1-sided, touch the [1-Sided] key. If the original is 2-sided, touch the [2-Sided] key.
- (2) Select the binding edge ([Left Binding] or [Right Binding]).
- (3) To insert a cover, touch the [Cover Setting] key.

If you do not want to add a cover, go to step 5.

4

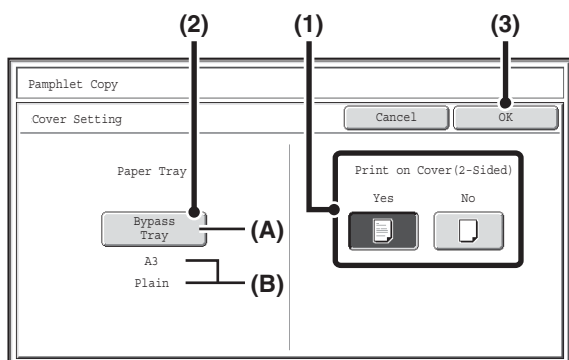

**Select cover settings.**

- (1) If the cover sheet will be copied on, touch the [Yes] key. Otherwise, touch the [No] key.
- (2) Select paper settings for the cover.

(A) The currently selected paper tray for the cover is displayed.

(B) The size and type of paper in the currently selected tray is displayed.

To change the paper tray for the cover, touch the "Paper Tray" key.

When the "Paper Tray" key is touched, a tray selection screen appears. Select the paper tray for the cover in the tray selection screen and touch the [OK] key.

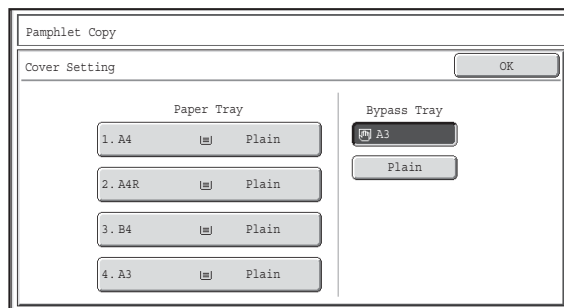

- (3) Touch the [OK] key.



If the cover will be copied on, label sheets, transparency film, and tab paper cannot be used.



**To cancel cover settings...**  
Touch the [Cancel] key.

5

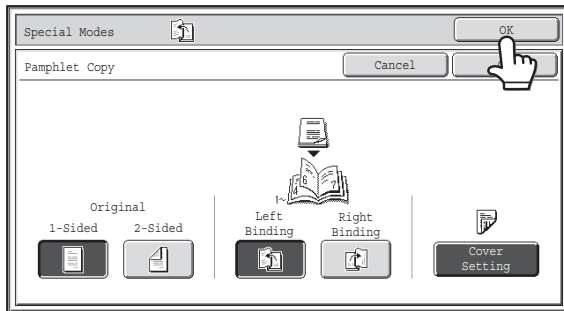

**Touch the [OK] key.**

You will return to the base screen of copy mode.

6

**Press the [COLOUR START] key or the [BLACK & WHITE START] key.**

Copying will begin.

If you are using the document glass, change originals and press the [START] key. Repeat until all pages have been scanned and then touch the [Read-End] key. (For the second original and following originals, use the same [START] key as you did for the first original.)



**To cancel scanning of the original and copying...**

Press the [STOP] key (⏹).



- To make pamphlet copies of a book or other bound original, use the book copy function.
- When the pamphlet copy function is selected, 2-sided copying mode is automatically selected. When settings are selected that prevent 2-sided copying, the pamphlet copy function cannot be used.
- Scan the originals in order from the first page to the last page. The order of copying will be automatically adjusted by the machine. Four original pages will be copied onto each sheet of paper. Blank pages will be automatically produced at the end if the number of original pages is not a multiple of four.



**To cancel pamphlet copy...**

Touch the [Cancel] key in the screen of step 3.

# COPYING A LARGE NUMBER OF ORIGINALS AT ONCE (Job Build)

This function requires the automatic document feeder to be installed.

When copying a very large number of originals, this function allows you to divide the originals into sets and feed each set through the automatic document feeder one set at a time.

Use this function when you wish to copy all of the originals as a single job but the number of originals exceeds the maximum number that can be inserted.

This function is convenient when you wish to sort copies of a large number of originals into multiple sets. Because all originals are copied as a single job, you are saved the trouble of sorting the copies that would be required if the originals were divided into separate copy jobs.

When scanning originals in sets, divide the sheets so that no set has more than the number of paper that can be loaded, and then scan from the set with the first page. The settings that you select for the first set can be used for all remaining sets.

## Sorting the copies of a large number of originals into 2 sets

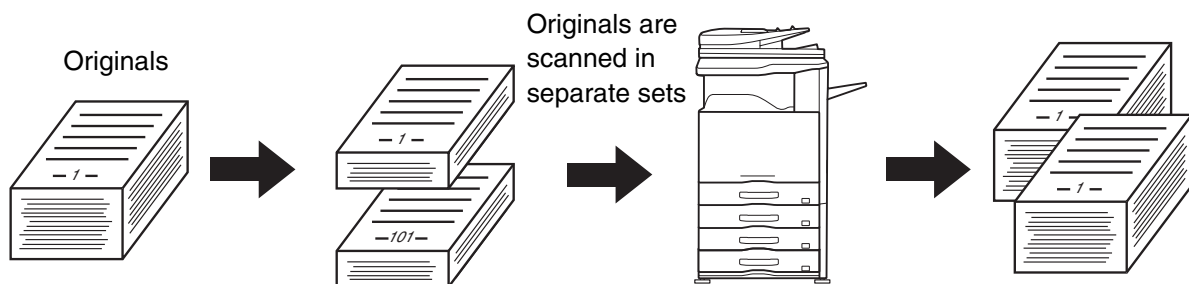

1

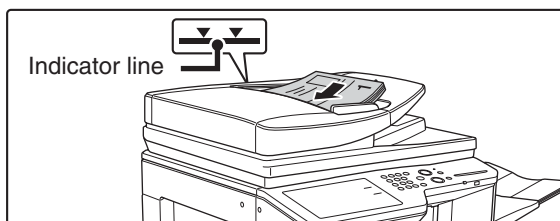

### Insert the originals face up in the document feeder tray.

Insert the originals all the way into the document feeder tray. Multiple originals can be placed in the document feeder tray. The stack of originals must not be higher than the indicator line on the tray.

2

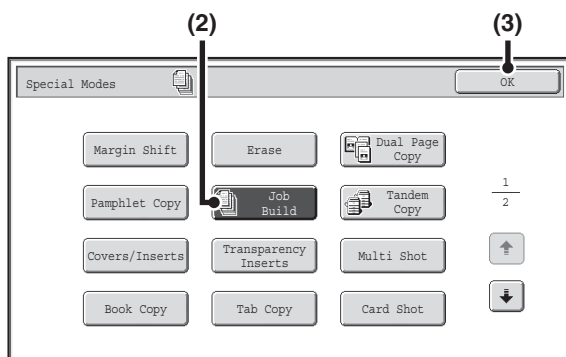

### Select Job Build.

- (1) Touch the [Special Modes] key.  
 ➔ [SPECIAL MODES](#) (page 2-41)
- (2) Touch the [Job Build] key so that it is highlighted.
- (3) Touch the [OK] key.  
 You will return to the base screen of copy mode.

**Press the [COLOUR START] key or the [BLACK & WHITE START] key to scan the first set of originals.**

3

Scanning begins.



**To cancel scanning...**

Press the [STOP] key (⏹).

**Insert the next set of originals and press the [COLOUR START] key or the [BLACK & WHITE START] key.**

4

Repeat this step until all originals have been scanned.



The copy settings (Exposure, Paper Select, and Copy Ratio only) can be changed for each set of originals. If you need to change the copy setting, follow the steps in "Changing the copy settings for each set of originals".



**To cancel scanning...**

Press the [STOP] key (⏹). All scanned data will be cleared.

5

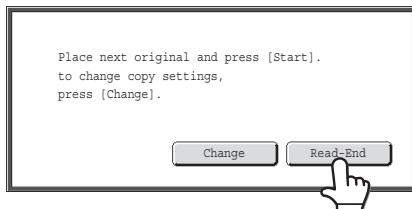

**Touch the [Read-End] key.**



**To cancel copying...**

Press the [STOP] key (⏹).



If the Quick File Folder of document filing mode is full, copying in job build mode will be impeded. Delete unneeded files from the Quick File Folder.



**To cancel job build mode....**

Touch the [Job Build] key in the screen of step 2 so that it is not highlighted.

## Changing the copy settings for each set of originals

The copy settings (Exposure, Paper Select, and Copy Ratio only) can be changed for each set of originals. Perform the step below before pressing the [Start] key to scan the originals in step 4 above.

1

Place next original and press [Start].  
to change copy settings,  
press [Change].

Change

Read-End



**Touch the [Change] key.**

2

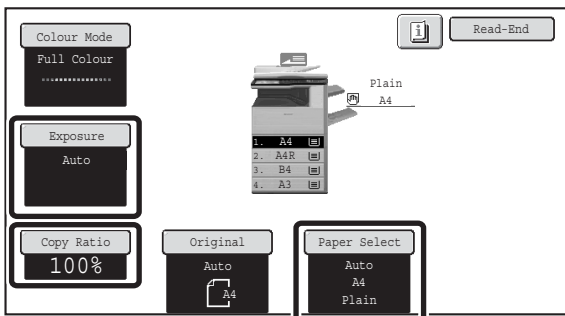

**Change the desired copy settings in the screen that appears and press the [Start] key.**

Scanning of the originals will begin using the changed copy settings.

To cancel the copy setting changes and begin copying without scanning the new originals, touch the [Read-End] key.

- The colour mode cannot be changed with the [Colour Mode] key.
  - The original size cannot be changed manually with the [Original] key. If the automatic original detection function is operating, the original size will be detected for each set of originals placed.
  - When the bypass tray is selected, it is not possible to change the paper type.
  - If "XY Zoom" was set for the ratio when the previous original was scanned, it will not be possible to change the ratio.
  - When "Job Build" is used in combination with the functions below, the [Change] key will not appear in the screen of step 1 above.
- Pamphlet copy, tandem copy, covers/inserts, transparency inserts, multi-shot, book copy, tab copy, staple sort

# USING TWO MACHINES TO MAKE A LARGE NUMBER OF COPIES (Tandem Copy)

(On the MX-2314N, the productivity kit is required.)

Two machines connected to the same network can be used to run a large copy job in parallel.

Each machine prints half of the copies, reducing the time required to complete the job.

## Master machine and slave machine

In the following explanation, the master machine is the machine that is used to scan the originals. The slave machine is another machine specified in the master machine that only helps print the copies; it is not used to scan the originals.

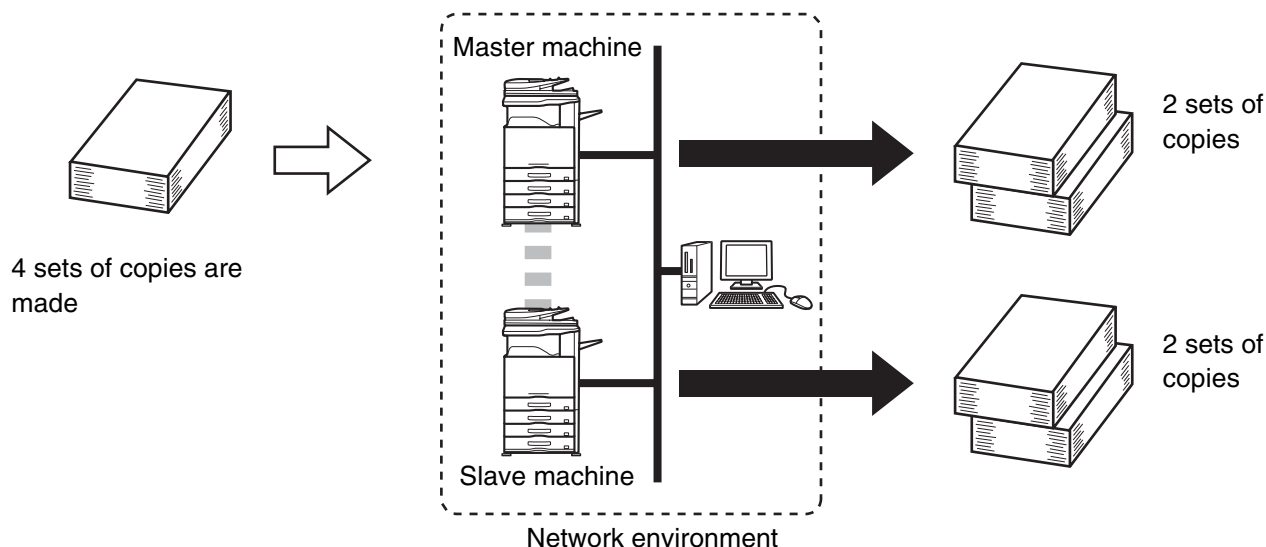

## Before using tandem copy

- To use this function, two machines must be connected to your network. Even if more machines are connected to the network, this function can only be used to have one other machine share a job.
- To use the tandem copy function, "Tandem Connection Setting" must be configured in the system settings (administrator).
- When configuring the system settings in the master machine, the IP address of the slave machine is required. For the port number, it is best to use the initial setting (50001). Unless you experience difficulty with this setting, do not change the port number. The tandem settings should be configured by your network administrator. If the master machine and slave machine will switch roles, configure the IP address of the master machine in the slave machine. The same port number can be used for both machines.

## 1 Place the original.

Place the original face up in the document feeder tray, or face down on the document glass.

## 2

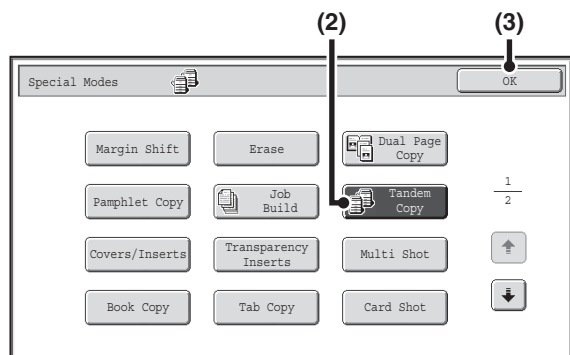

## Select tandem copy.

- (1) Touch the [Special Modes] key.  
 ➔ [SPECIAL MODES](#) (page 2-41)
- (2) Touch the [Tandem Copy] key so that it is highlighted.
- (3) Touch the [OK] key.  
 You will return to the base screen of copy mode.



3

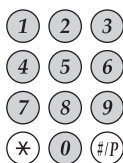

### Set the number of copies (number of sets) with the numeric keys.

Up to 999 copies (sets) can be set. When the [COLOUR START] key or the [BLACK & WHITE START] key is pressed, the copies will automatically be divided between the master and slave machines.

If an odd number of copies is set, the master machine will print the extra set.



#### If an incorrect number of copies is set...

Press the [CLEAR] key (C) and then enter the correct number.

4

### Press the [COLOUR START] key or the [BLACK & WHITE START] key.

Copying will begin.

If you are using the document glass, change originals and press the [START] key. Repeat until all pages have been scanned and then touch the [Read-End] key. (For the second original and following originals, use the same [START] key as you did for the first original.)

The following screen appears when the [START] key is pressed.

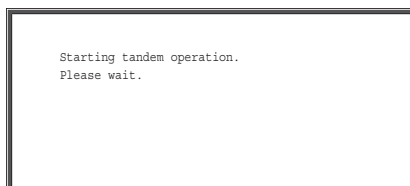

After the message appears, tandem copying begins.

If tandem copying is not possible, the following screen appears.

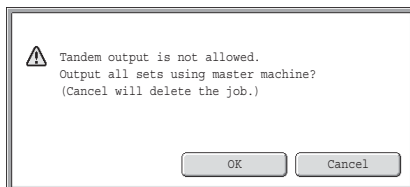

To have the master machine make all copies, touch the [OK] key. To cancel the job, touch the [Cancel] key.



- **To cancel scanning...**

Press the [STOP] key (⏹).

- **To cancel tandem copying...**

Touch the [STOP] keys (⏹) on both the master machine and the slave machine.

**In this situation...****If a machine runs out of paper**

If either the master machine or the slave machine run out of paper, the machine that ran out of paper will hold the job while the machine that still has paper continues the job. When paper is added to the machine that ran out, the job resumes.

**When user authentication is enabled**

User authentication is enabled in the master machine: tandem copying is possible.

User authentication is enabled in the slave machine but not in the master machine: tandem copying is not possible.

**If tandem copying is performed without setting the number of copies**

A message will appear and the master machine and slave machine will each make one set of copies (total of two sets).

**To cancel tandem copy...**

Touch the [Tandem Copy] key in the screen of step 2 so that it is not highlighted.

**System Settings (Administrator): Tandem Connection Setting**

This must be configured to use the tandem function. This can also be used to disable the tandem function.

# USING A DIFFERENT PAPER TYPE FOR COVERS (Covers/Inserts)

A different type of paper can be inserted in positions corresponding to front and back covers of a copy job when the automatic document feeder is used. A different type of paper can also be automatically added as an insert at specified pages.

Example of adding covers

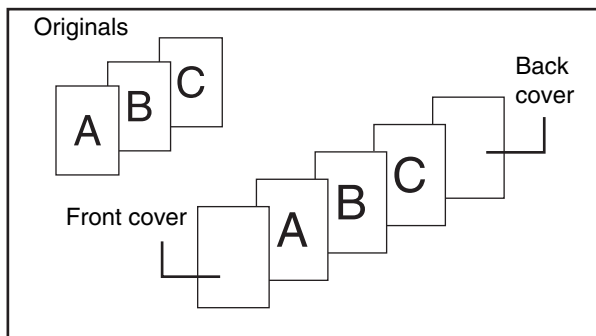

Example of adding inserts

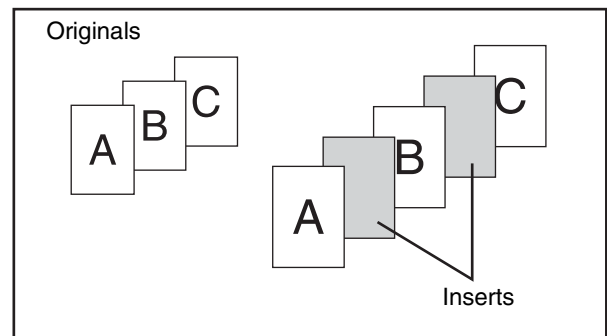

Example of adding covers/inserts

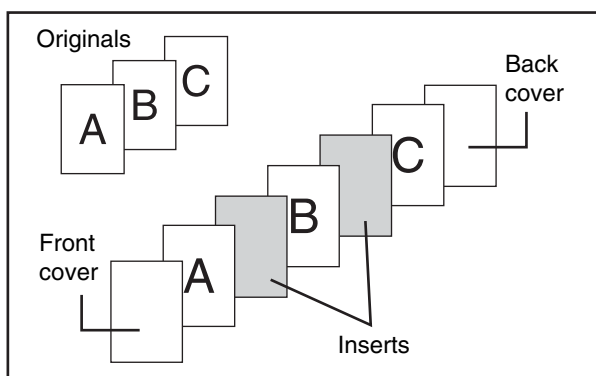

## About the explanations of covers and inserts

There are various ways of using covers and inserts. To keep the explanations simple, covers and inserts are explained separately. For specific examples, see "[Examples of covers and inserts](#)" (page 2-148).

## Preparations for using covers and inserts

- Load the cover/insert paper in the tray before using the cover/insert function.
- Before selecting the cover/insert function, place the originals in the document feeder tray, select 1-sided or 2-sided copying, and select the number of copies and any other desired copy settings. When these settings have been completed, perform the procedure to select covers/inserts.
- The originals must be scanned using the automatic document feeder. The document glass cannot be used.
- For covers, only one sheet can be inserted for the front cover and only one sheet can be inserted for the back cover. For inserts, up to 100 sheets can be inserted. Note that two insert sheets cannot be inserted between the same two pages.
- When performing 2-sided copying of 2-sided originals, an insert cannot be inserted between the front and reverse sides of an original.

# INSERTING COVERS IN COPIES (Cover Settings)

A different type of paper can be inserted at the positions corresponding to the front and back covers of a copy job. This is useful for arranging documents in an attractive format and for using a different type of paper as a cover on an estimate sheet or similar document.

Covers can be used in combination with inserts.

## Copying on a front cover and inserting together with a back cover

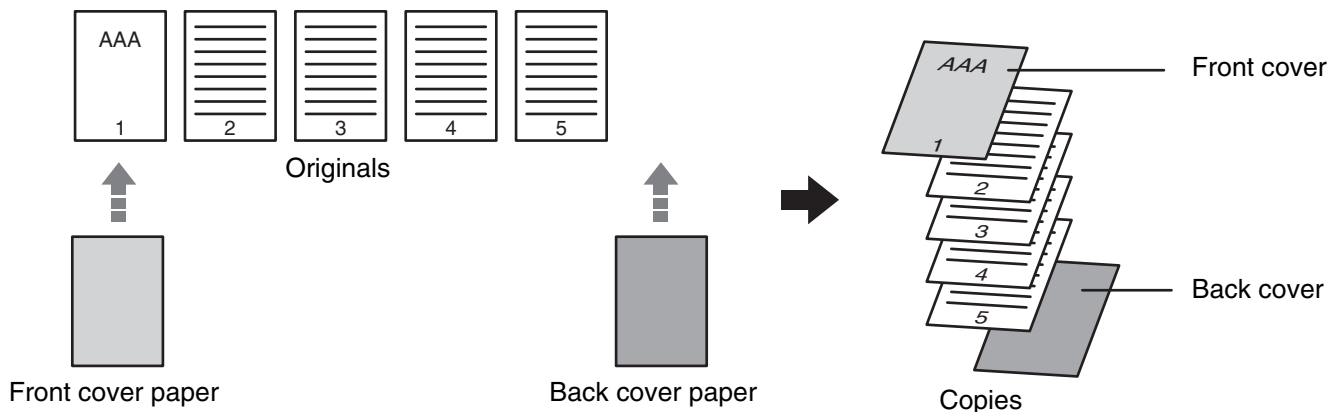

1

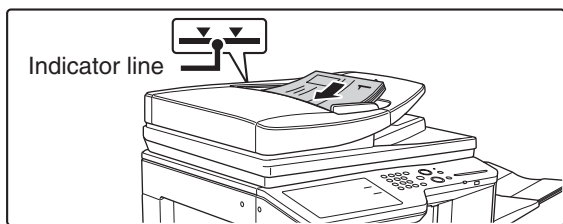

### Insert the originals face up in the document feeder tray.

Insert the originals all the way into the document feeder tray. Multiple originals can be placed in the document feeder tray. The stack of originals must not be higher than the indicator line on the tray.



The document glass cannot be used.

2

### Select the special modes.

(1) Touch the [Special Modes] key.

(2) Touch the [Covers/Inserts] key.

[Special modes menu \(1st screen\)](#) (page 2-41)

3

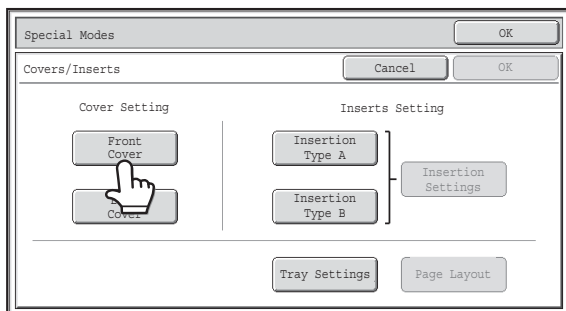

### Touch the [Front Cover] key.

4

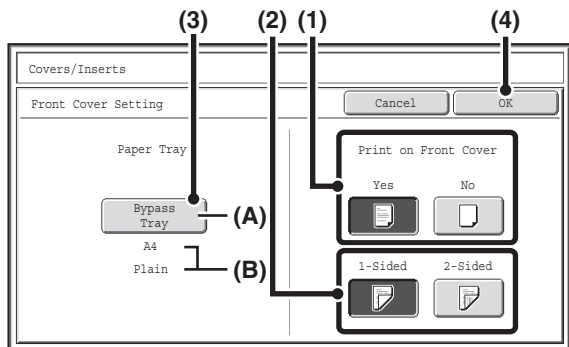

Select cover settings.

(1) If the cover sheet will be copied on, touch the [Yes] key. Otherwise, touch the [No] key.

If the [No] key is touched, only cover insertion will be performed.

In this case, go to step (3).

(2) To copy on one side of the cover, touch the [1-Sided] key. To copy on both sides of the cover, touch the [2-Sided] key.

(3) Select paper settings for the cover.

(A) The currently selected paper tray for the cover is displayed.

(B) The size and type of paper in the currently selected tray is displayed.

To change the paper tray for the cover, touch the "Paper Tray" key.

When the "Paper Tray" key is touched, a tray selection screen appears. Select the paper tray for the cover in the tray selection screen and touch the [OK] key.

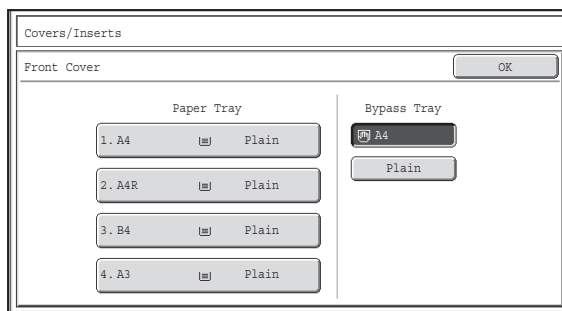

(4) Touch the [OK] key.



If the cover will be copied on, label sheets, transparency film, and tab paper cannot be used. If not copied on, tab paper can be inserted.



To cancel cover settings... Touch the [Cancel] key.

5

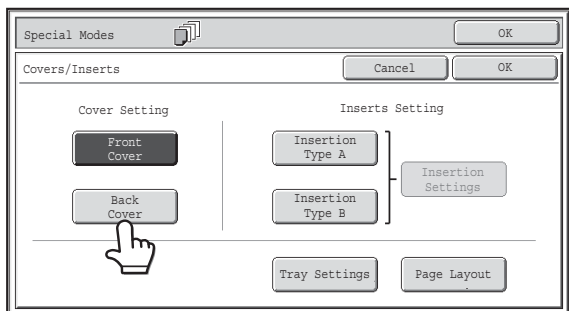

If you wish to insert a back cover, touch the [Back Cover] key.

The screen of step 4 appears. The procedures are the same as for the front cover. Follow the procedures in step 4.

When following the procedures, substitute "Back Cover" for "Front Cover".

6

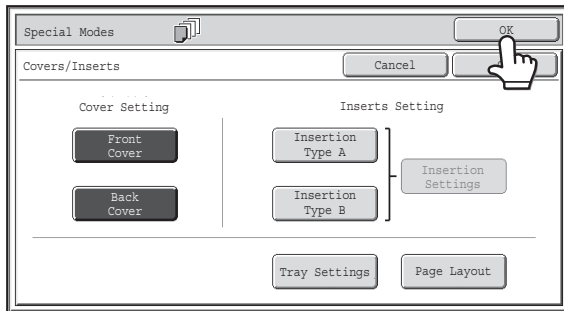

### Touch the [OK] key.

You will return to the base screen of copy mode.

You can touch the [Insertion Type A] key or the [Insertion Type B] key to select insert settings.

➤ [INSERTING INSERT SHEETS IN COPIES \(Insert Settings\)](#) (page 2-63)

To check your settings, touch the [Page Layout] key.

➤ [CHANGING COVER/INSERT SETTINGS \(Page Layout\)](#) (page 2-67)

7

### Press the [COLOUR START] key or the [BLACK & WHITE START] key.

Copying of the originals in the document feeder tray begins.



#### To cancel scanning and copying...

Press the [STOP] key (⏹).



- The document glass cannot be used.
- Cover settings cannot be selected if insertion of covers and inserts is disabled in the system settings (administrator).



#### To cancel cover sheet insertion...

Touch the [Cancel] key in the screen of step 3.

# INSERTING INSERT SHEETS IN COPIES (Insert Settings)

You can have different paper automatically inserted as inserts at specified pages of copies. Two types of paper can be used as inserts, and the insertion positions can be specified separately for each. Covers can be used in combination with inserts.

**Example: Insert A after page 3 and insert B after page 5.**

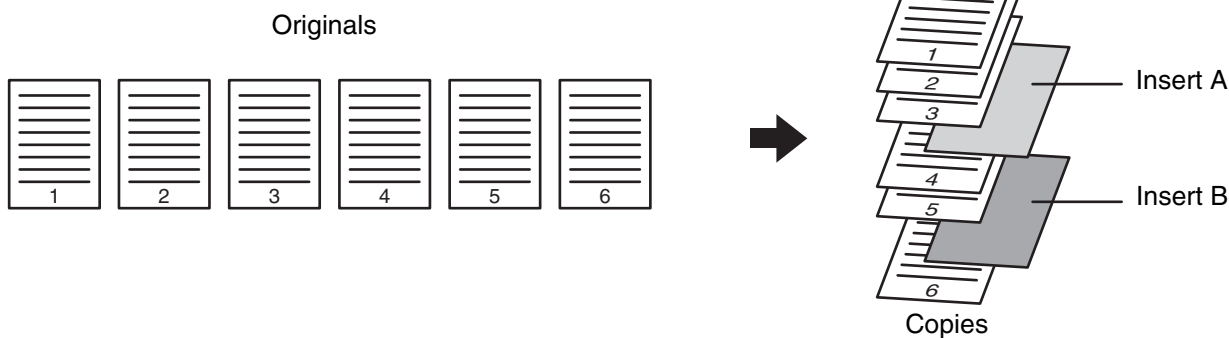

**1**

**Insert the originals face up in the document feeder tray.**

Insert the originals all the way into the document feeder tray. Multiple originals can be placed in the document feeder tray. The stack of originals must not be higher than the indicator line on the tray.

---

The document glass cannot be used.

2

**Select the special modes.**

(1) Touch the [Special Modes] key.

(2) Touch the [Covers/Inserts] key.

[Special modes menu \(1st screen\)](#) (page 2-41)

3

**Touch the [Insertion Type A] key.**

4

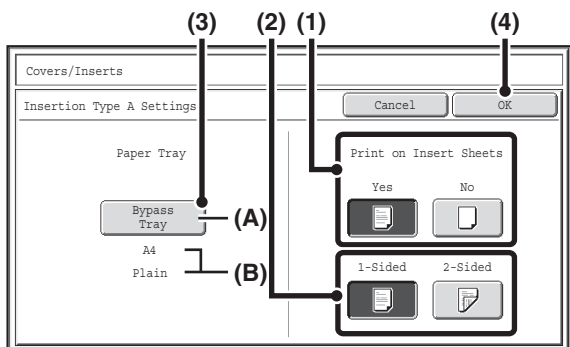

Select insert settings.

- (1) If the insert will be copied on, touch the [Yes] key. Otherwise, touch the [No] key. If the [No] key is touched, only insert sheet insertion will be performed. In this case, go to step (3).
- (2) To copy on one side of the insert, touch the [1-Sided] key. To copy on both sides, touch the [2-Sided] key.
- (3) Select insert paper settings.
  - (A) The currently selected paper tray for the insert is displayed.
  - (B) The size and type of paper in the currently selected tray is displayed.
 To change the paper tray for the inserts, touch the "Paper Tray" key. When the "Paper Tray" key is touched, a tray selection screen appears. Select the desired paper tray in the tray selection screen and touch the [OK] key.

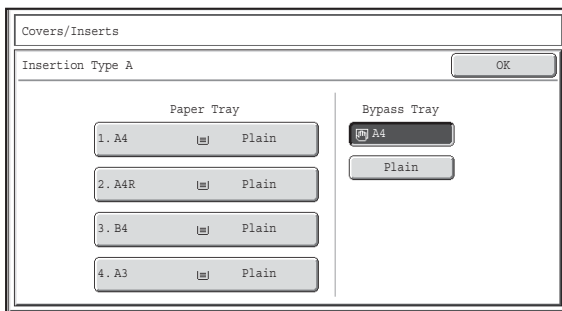

- (4) Touch the [OK] key.



If both sides of the insert will be copied on, label sheets, transparency film, and tab paper cannot be used. If not copied on, tab paper can be inserted.

5

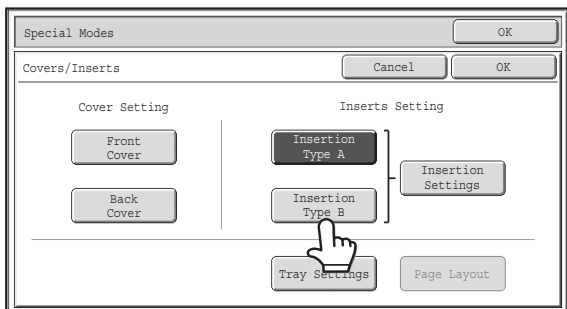

If you wish to insert a different type of insert sheet, touch the [Insertion Type B] key.

The screen of step 4 appears. Settings are selected in the same way as for insert type A. Follow the procedures in step 4. When following the procedures, substitute "Insert Type B" for "Insert Type A".



6

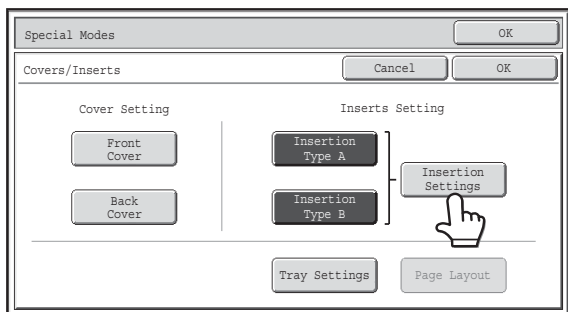

Touch the [Insertion Settings] key.

7

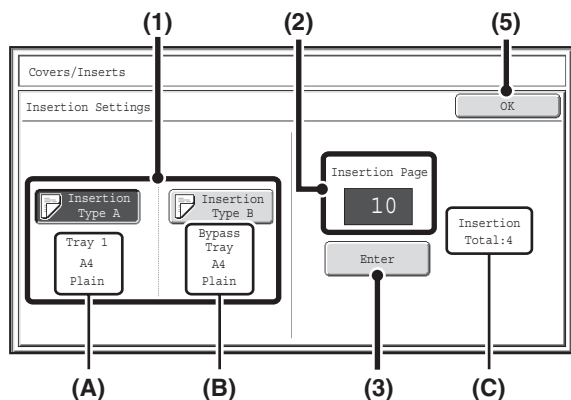

Specify the pages where inserts A and B will be inserted.

(1) Touch the [Insertion Type A] key or the [Insertion Type B] key.

Specify the page where the highlighted insert will be inserted.

- (A) This shows the tray selected for insert type A and the paper size and type.
- (B) This shows the tray selected for insert type B and the paper size and type.

When the [Insertion Type A] key is highlighted, the insert sheet insertion settings are applied to [Insertion Type A]. When the [Insertion Type B] key is highlighted, the insert settings are applied to [Insertion Type B].

(2) Enter the page number where the insert sheet will be inserted with the numeric keys.

For more information, see "[Inserts \(copying of 1-sided originals\)](#)" (page 2-153) and "[Inserts \(copying of 2-sided originals\)](#)" (page 2-153).

The [CLEAR] key (Ⓢ) can be pressed to return the setting of the selected item to the default value. If you make a mistake, press the [CLEAR] key (Ⓢ) and then enter the correct number.

(3) Touch the [Enter] key.

(C) This shows the total number of inserts. Up to 100 insert sheets can be inserted. To insert multiple inserts, touch the [Enter] key after entering each insertion page number (insertion position) with the numeric keys.

(4) To insert another insert sheet, repeat steps (1) to (3).

(5) Touch the [OK] key.



If both sides of the insert will be copied on, label sheets, transparency film, and tab paper cannot be used. If not copied on, tab paper can be inserted.

8

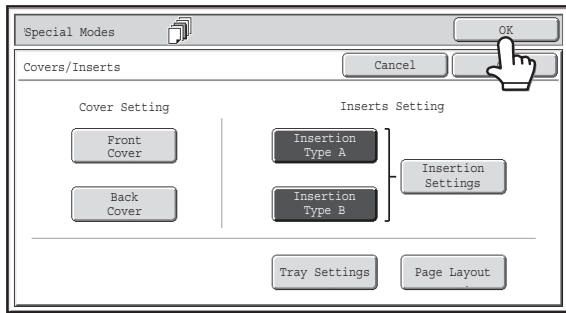

### Touch the [OK] key.

You will return to the base screen of copy mode.

To select cover settings, touch the [Front Cover] key or the [Back Cover] key.

➤ [INSERTING COVERS IN COPIES \(Cover Settings\)](#) (page 2-60)

To check your settings, touch the [Page Layout] key.

➤ [CHANGING COVER/INSERT SETTINGS \(Page Layout\)](#) (page 2-67)

9

### Press the [COLOUR START] key or the [BLACK & WHITE START] key.

Copying of the originals in the document feeder tray begins.



#### To cancel scanning and copying...

Press the [STOP] key (⏹).



- Use the same size of paper for the inserts as for the copies.
- Up to 100 insert sheets can be added. Note that two insert sheets cannot be inserted between the same two pages.
- When performing 2-sided copying of 2-sided originals, an insert cannot be added between the front and reverse sides of an original page.
- Cover/insert settings cannot be selected if insertion of covers and inserts is disabled in the system settings (administrator).



#### To cancel cover sheet insertion...

Touch the [Cancel] key in the screen of step 3.

# CHANGING COVER/INSERT SETTINGS (Page Layout)

Cover settings and insert settings can be combined.

This section explains how to check completed cover and insert insertion page settings, and change or delete insertion pages.

## Changing insert A from page 4 to page 5

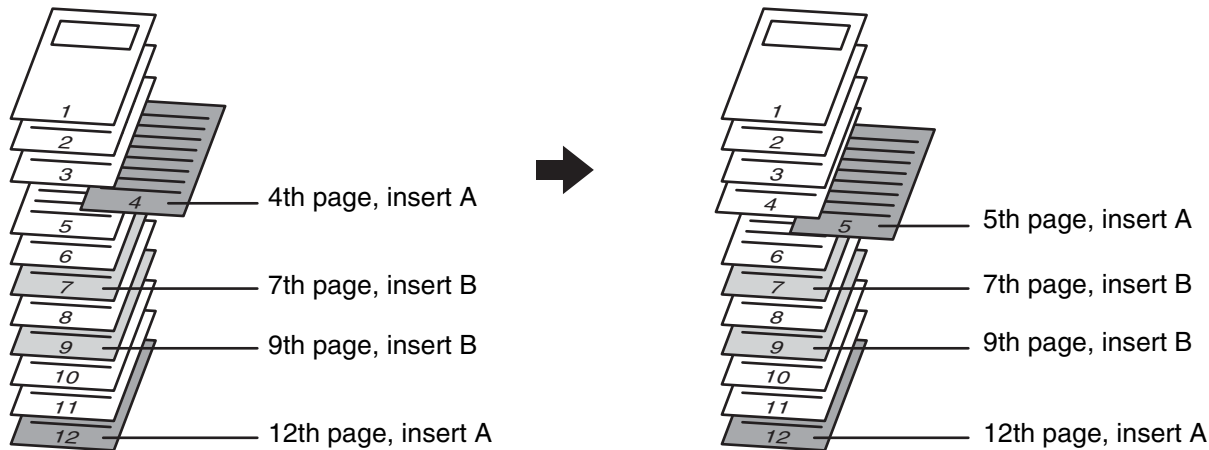

1

### Select the special modes.

- (1) Touch the [Special Modes] key.
  - (2) Touch the [Covers/Inserts] key.
- ☞ [Special modes menu \(1st screen\)](#) (page 2-41)

2

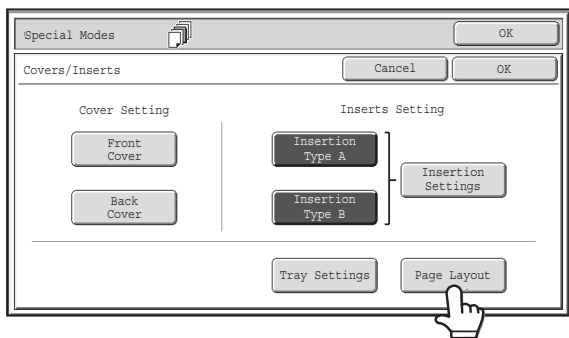

Touch the [Page Layout] key.

**Example: Touch insert A at page 4**

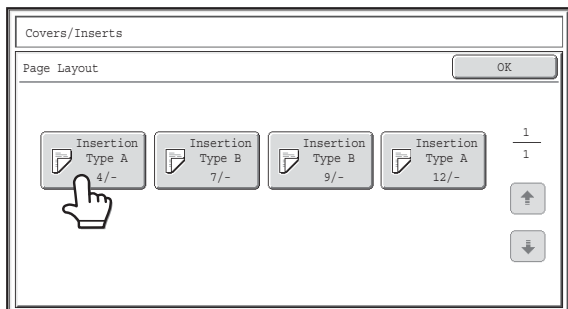

3

**Touch the key of the page that you wish to delete or change.**

If you do not need to change the setting, touch the [OK] key and go to step 6.

- Each key shows a print image icon and the insertion page.
- If there are multiple screens, touch the [↓] [↑] keys to move through the screens.

To edit a cover, touch the [Front Cover] key or the [Back Cover] key and go to step 4.

Touch the key of the insertion page that you want to edit or clear. The following screen will appear.

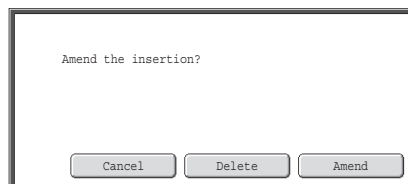

- To delete the page, touch the [Delete] key. After deleting the key, touch the [OK] key and go to step 6.
- To edit the page, touch the [Amend] key.  
To edit an insert, touch the [Insertion Type A] key or the [Insertion Type B] key and go to step 5.
- To cancel, touch the [Cancel] key.



**Icons**

- : Copy on front side only
- : Copy on reverse side only
- : 2-sided copy
- : Do not copy

For inserts, the insertion page also appears.

- \* represents a page number.
- \*/-: Copy only on front side at page \*
- \*/\*: 2-sided copy at page \*/\*
- <\*: Insert without copying at page \*

4

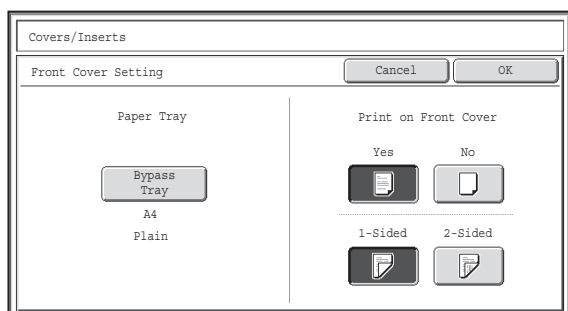

**Change the front/back cover settings.**

The settings are changed in the same way as they are initially configured. See step 4 of "INSERTING COVERS IN COPIES (Cover Settings)" (page 2-60) to change the cover settings. After changing the settings, touch the [OK] key and return to step 3.



**To cancel cover settings...**

Touch the [Cancel] key.

5

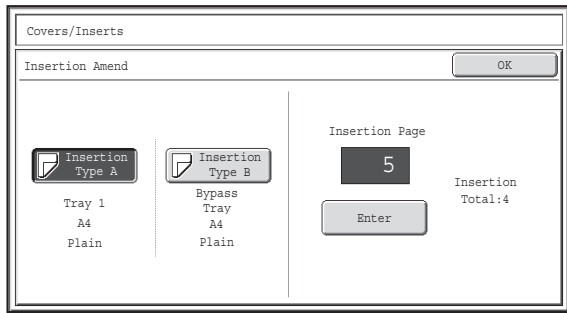

**Change the settings for insert type A/B.**

The settings are changed in the same way as they are initially configured. See step 7 of "INSERTING INSERT SHEETS IN COPIES (Insert Settings)" (page 2-63) to change the insert settings.

After changing the settings, touch the [OK] key and return to step 3.

6

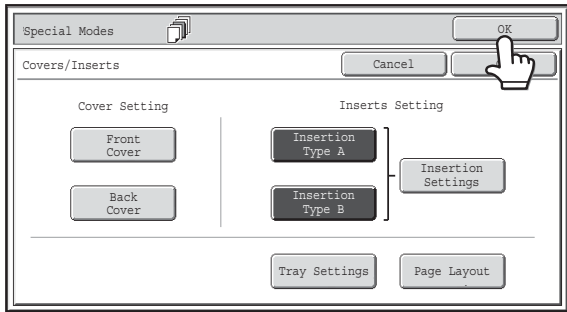

**Touch the [OK] key.**

You will return to the base screen of copy mode.

# ADDING INSERTS WHEN COPYING ON TRANSPARENCY FILM

## (Transparency Inserts)

When copying on transparency film, the sheets may stick together due to static electricity. The transparency inserts function can be used to automatically insert a sheet of paper between each sheet of transparency film, making the sheets easy to handle.

It is also possible to copy on the inserts.

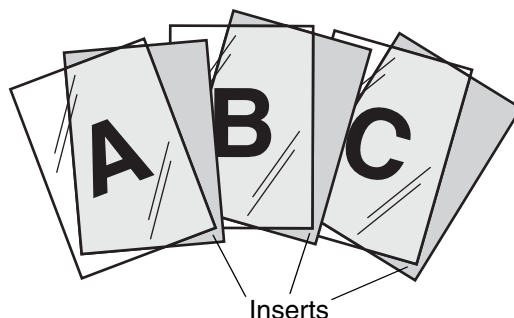

1

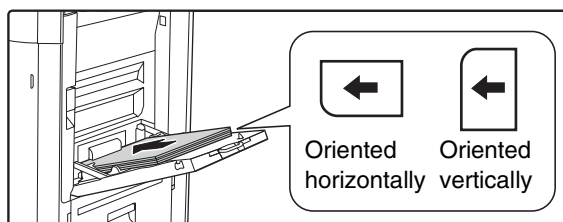

### Place the transparency film in the bypass tray.

- Transparency film can only be placed in the bypass tray.
- Place the transparency film face down on the bypass tray. When placing the transparency film, the rounded corner of the film should be:
  - At the front and left if the film is oriented horizontally.
  - At the back and left if the film is oriented vertically.
- After loading the transparency film, configure the bypass tray settings as explained in "[MAKING COPIES USING THE BYPASS TRAY](#)" (page 2-38).

2

### Place the original.

Place the original face up in the document feeder tray, or face down on the document glass.

3

### Select the special modes.

- (1) Touch the [Special Modes] key.
- (2) Touch the [Transparency Inserts] key.

 [Special modes menu \(1st screen\)](#) (page 2-41)

4

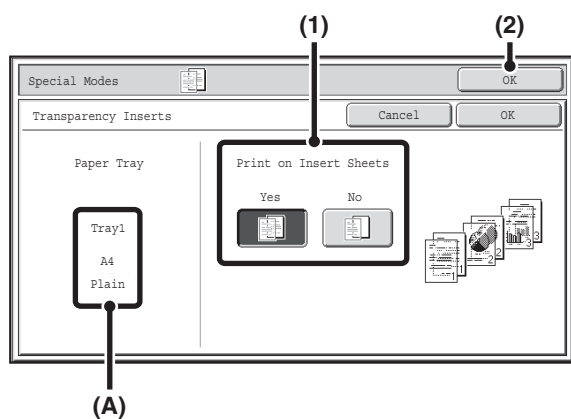

### Select insert settings.

(1) Select whether or not the insert paper will be copied on ([Yes] or [No]).

(2) Touch the [OK] key.

You will return to the base screen of copy mode.



#### Explanation of (A)

When transparency inserts is selected, paper suitable for the inserts is automatically selected. The automatically selected paper tray, paper size, and paper type are indicated here.

5

### Press the [COLOUR START] key or the [BLACK & WHITE START] key.

Copying will begin.

 **To cancel scanning and copying...**  
Press the [STOP] key (.



- The number of copies cannot be selected in this mode.
- When performing 2-sided copying, only "2-sided to 1-sided" mode can be used.



**To cancel the transparency inserts setting...**  
Touch the [Cancel] key in the screen of step 4.

# COPYING MULTIPLE ORIGINALS ONTO ONE SHEET (Multi Shot)

Multiple original pages can be copied onto a single sheet of paper in a uniform layout. Select 2in1 to copy two original pages onto one sheet, or 4in1 to copy four original pages onto one sheet. This function is convenient when you wish to present multiple pages in a compact format, or show a view of all pages in a document.

## 2in1 copying

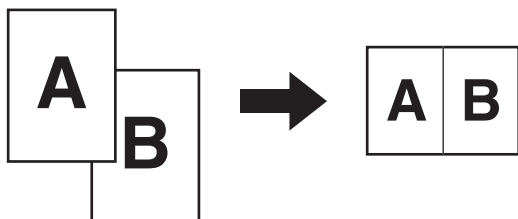

## 4in1 copying

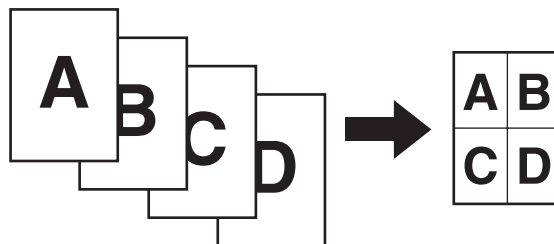

### 1 Place the original.

Place the original face up in the document feeder tray, or face down on the document glass.

### 2

#### Select the special modes.

(1) Touch the [Special Modes] key.

(2) Touch the [Multi Shot] key.

 [Special modes menu \(1st screen\)](#) (page 2-41)



3

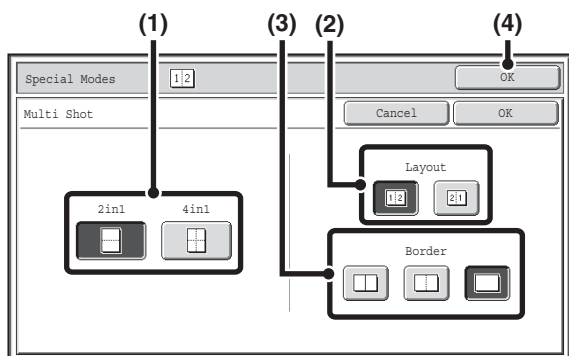

Select the number of originals to be copied onto one sheet of paper, the layout, and the border.

(1) Touch the [2in1] key or the [4in1] key.

If needed, the images will be rotated.

(2) Select the layout.

Select the order in which the originals will be arranged on the copy.

Number of pages	Layout
2in1	
4in1	

The arrows in the above diagram indicate how the images are arranged.

(3) Select the border.

Solid lines, broken lines, or no lines can be selected.

(4) Touch the [OK] key.

You will return to the base screen of copy mode.

4

Press the [COLOUR START] key or the [BLACK & WHITE START] key.

Copying will begin.

If you are using the document glass, change originals and press the [START] key. Repeat until all pages have been scanned and then touch the [Read-End] key. (For the second original and following originals, use the same [START] key as you did for the first original.)

To cancel scanning and copying...  
Press the [STOP] key ().

When using the multi shot function, the appropriate copy ratio will be automatically set based on the original size, paper size, and the number of originals to be copied onto one sheet. The minimum possible reduction ratio is 25%. The original size, paper size, and selected number of original pages may require that the ratio be less than 25%. As copying will take place at 25% in this case, part of the original images may be cut off.

To cancel a multi shot setting...  
Touch the [Cancel] key in the screen of step 3.

# COPYING A PAMPHLET (Book Copy)

This function is used to make a copy of the two facing pages of an open book or other bound document.

Copies made with this function can be folded at the centre to create a booklet.

This function is convenient for arranging copies into an attractive booklet or pamphlet.

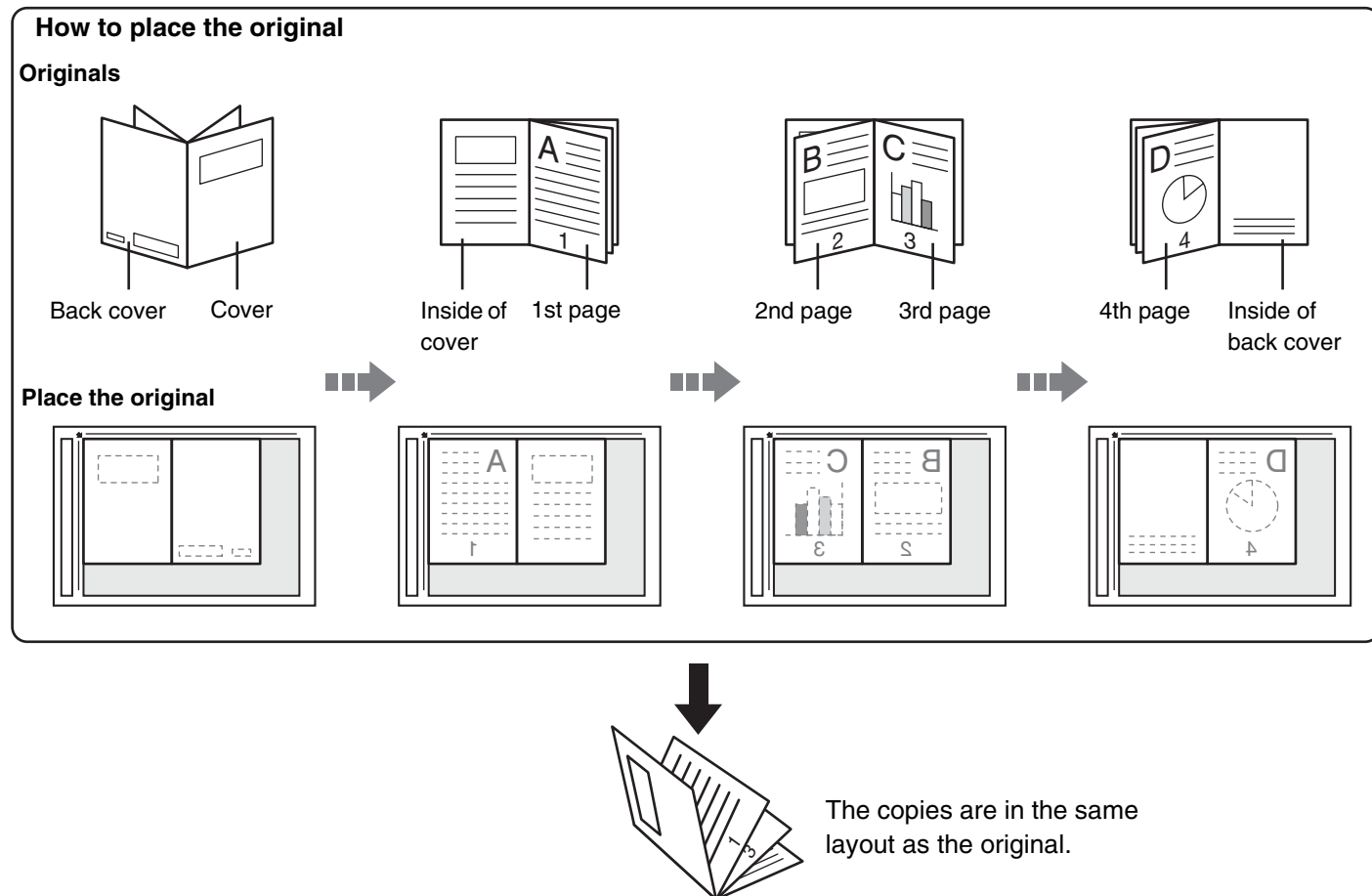

## Select the special modes.

1

(1) Touch the [Special Modes] key.

(2) Touch the [Book Copy] key.

 [Special modes menu \(1st screen\)](#) (page 2-41)

2

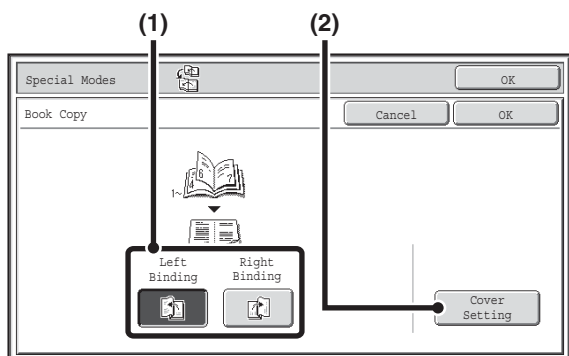

**Select book copy settings.**

- (1) Select the binding position ([Left Binding] or [Right Binding]).
- (2) To insert a cover, touch the [Cover Setting] key.

If a cover will not be added, go to step 4.



Cover settings cannot be selected if insertion of covers and inserts is disabled in the system settings (administrator).

3

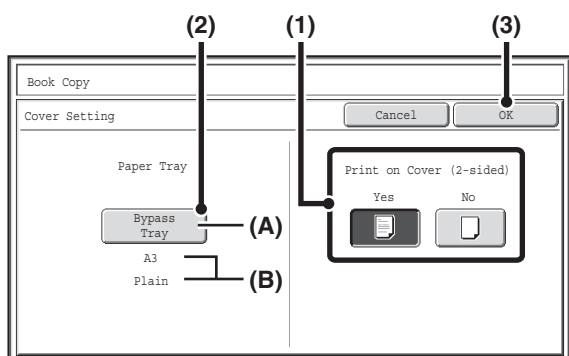

**Select cover settings.**

- (1) If the cover sheet will be copied on, touch the [Yes] key. Otherwise, touch the [No] key.
- (2) Select paper settings for the cover.

(A) The currently selected paper tray for the cover is displayed.

(B) The size and type of paper in the currently selected tray is displayed.

In the example screen, A3 (11" x 17") size plain paper is loaded in the bypass tray.

To change the paper tray for the cover, touch the "Paper Tray" key.

When the "Paper Tray" key is touched, a tray selection screen appears. Select the desired paper tray in the tray selection screen and touch the [OK] key.

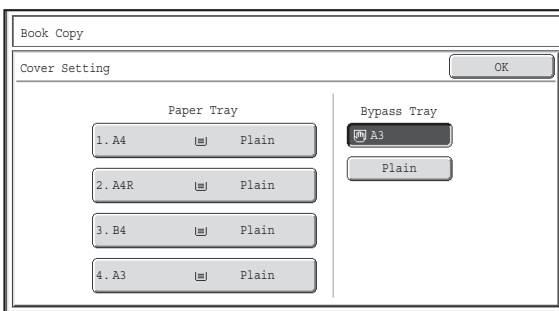

- (3) Touch the [OK] key.



If the cover will be copied on, label sheets, transparency film, and tab paper cannot be used.



**To cancel cover settings...**  
Touch the [Cancel] key.

4

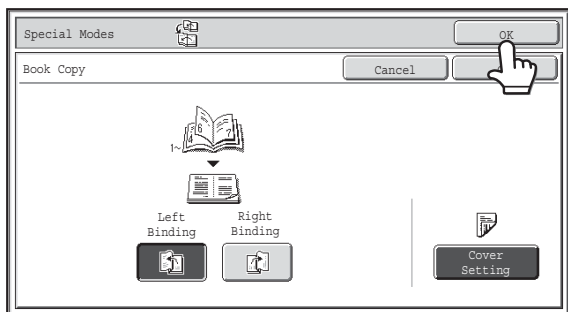

**Touch the [OK] key.**

You will return to the base screen of copy mode.

5

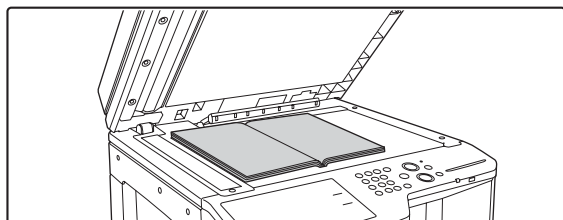

**Place the original face down on the document glass.**

Place the opened front cover and back cover face down.

6

**Press the [COLOUR START] key or the [BLACK & WHITE START] key to scan the first original.**

Scanning begins.

Scan the remaining original pages in the following order:

Opened inside of front cover and 1st page

Opened 2nd and 3rd page

⋮

Opened last page and inside of back cover



**To cancel scanning...**

Press the [STOP] key (⏹).

7

**Place the next pair of opened pages and press the [COLOUR START] key or the [BLACK & WHITE START] key.**

Repeat this step until all original pages have been scanned.

For the second original and following originals, use the same [START] key as you did for the first original.



**To cancel scanning...**

Press the [STOP] key (⏹).

8

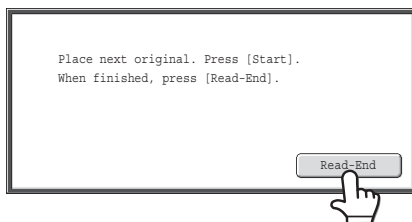
**Touch the [Read-End] key.**

Copying will begin.

**To cancel scanning and copying...**

Press the [STOP] key (⏹).



- Four original pages will be copied onto each sheet of paper. Blank pages will be automatically added at the end if the total number of original pages is not a multiple of four.
- When book copy is selected, 2-sided copying is automatically selected. When settings are selected that prevent 2-sided copying, the book copy function cannot be used.

**To cancel book copy...**

Touch the [Cancel] key in the screen of step 2.

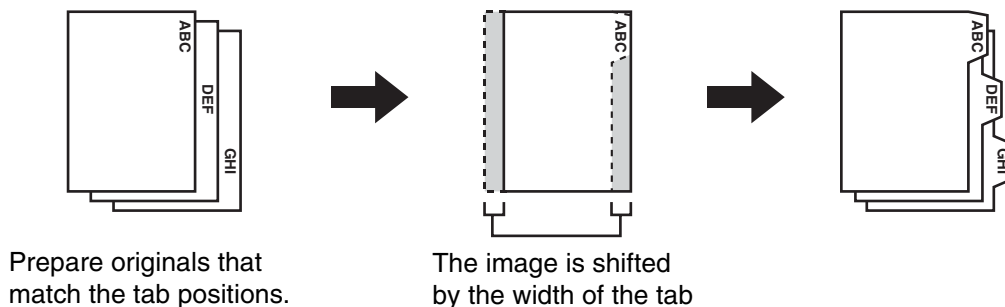

# COPYING CAPTIONS ONTO TAB PAPER (Tab Copy)

Captions can be copied onto the tabs of tab paper. Prepare appropriate originals for the tab captions.  
Tab copy is possible from the bypass tray.



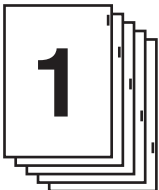
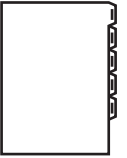
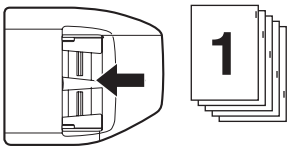

## RELATION BETWEEN THE ORIGINALS AND THE TAB PAPER

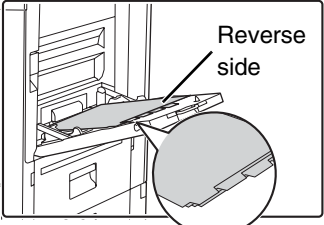
### Tab copying with a left binding

Originals	Placing the originals	Loading tab paper
<p>Originals</p>  <p>Final image</p> 	<ul style="list-style-type: none"> <li>Document feeder tray</li> </ul>  <p>Insert the originals so that the side with no tab text enters first.</p> <ul style="list-style-type: none"> <li>Document glass</li> </ul>  <p>Place so that the side with the tab text is on the left.</p>	 <p>Reverse side</p> <p>Load the tab paper so that the tab on the first sheet is toward you.</p>

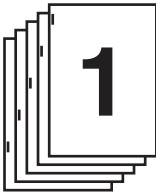
## Tab copying with a right binding

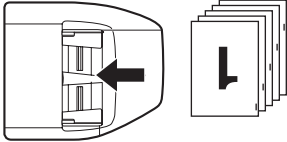
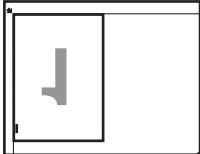
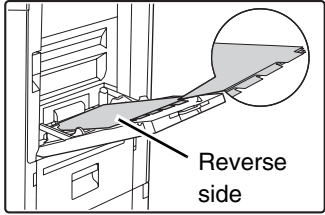
Originals	Placing the originals	Loading tab paper
<p>Originals</p>  <p>Final image</p> 	<ul style="list-style-type: none"> <li>• Document feeder tray</li> </ul>  <p>Insert the originals so that the side with no tab text enters first.</p> <ul style="list-style-type: none"> <li>• Document glass</li> </ul>  <p>Place so that the side with the tab text is on the left.</p>	 <p>Reverse side</p> <p>Load the tab paper so that the tab on the first sheet is away from you.</p>

1

### Place the original.

Place the original face up in the document feeder tray, or face down on the document glass.

2

### Select the special modes.

(1) Touch the [Special Modes] key.

(2) Touch the [Tab Copy] key.

 [Special modes menu \(1st screen\)](#) (page 2-41)

3

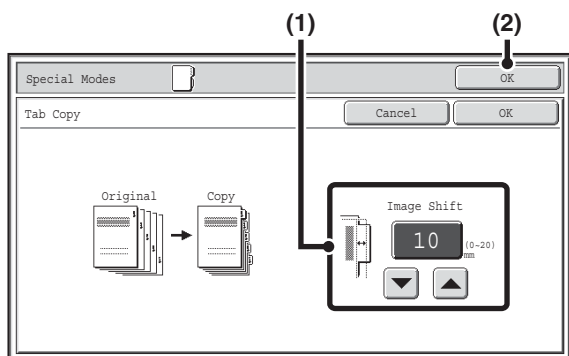

### Set the tab width.

(1) Set the image shift width (tab width) with the   keys.

0 mm to 20 mm (0" to 5/8") can be entered.

You can also directly touch a numeric value display key to change a number with the numeric keys.

(2) Touch the [OK] key.

You will return to the base screen of copy mode.

4

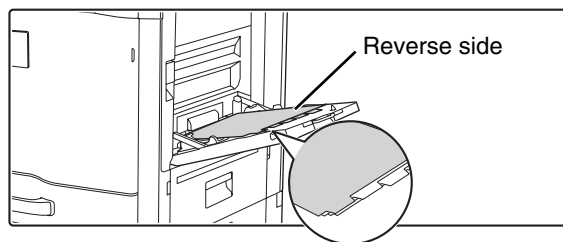

### Load the tab paper.

When using the bypass tray, place the paper with the print side down.

Place the paper so that the sides with the tabs enter the machine last.

After loading the tab paper, configure the bypass tray settings as explained in "[MAKING COPIES USING THE BYPASS TRAY](#)" (page 2-38).



The width of the tab paper can be as wide as A4 width (210 mm) plus 20 mm (or 8-1/2" x 11" paper (8-1/2") plus 5/8").

5

### Press the [COLOUR START] key or the [BLACK & WHITE START] key.

Copying will begin.

If you are using the document glass to copy multiple original pages, copying will take place as you scan each original. If you have selected sort mode, change originals and press the [START] key. Repeat until all pages have been scanned and then touch the [Read-End] key. (For the second original and following originals, use the same [START] key as you did for the first original.)



#### To cancel scanning and copying...

Press the [STOP] key (⏹).



#### To cancel tab copy...

Touch the [Cancel] key in the screen of step 3.



#### System Settings (Administrator): Initial Tab Copy Setting

The default image shift width can be set from 0 mm to 20 mm (0" to 5/8"). The factory default setting is "10 mm (1/2)".



# COPYING BOTH SIDES OF A CARD ON ONE SHEET OF PAPER (Card Shot)

When copying a card, this function allows you to copy the front and reverse sides together onto a single sheet of paper. This function is convenient for making copies for identification purposes and helps save paper.

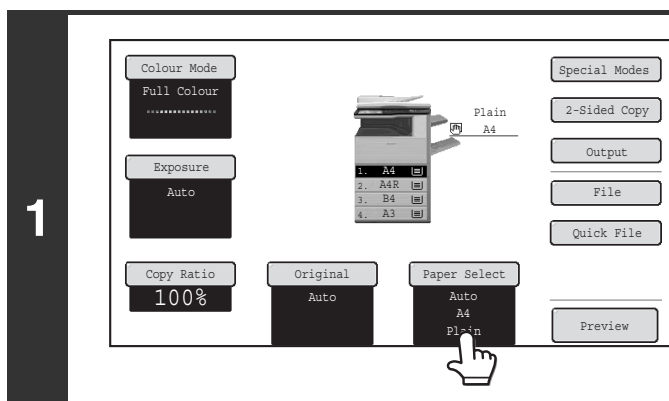
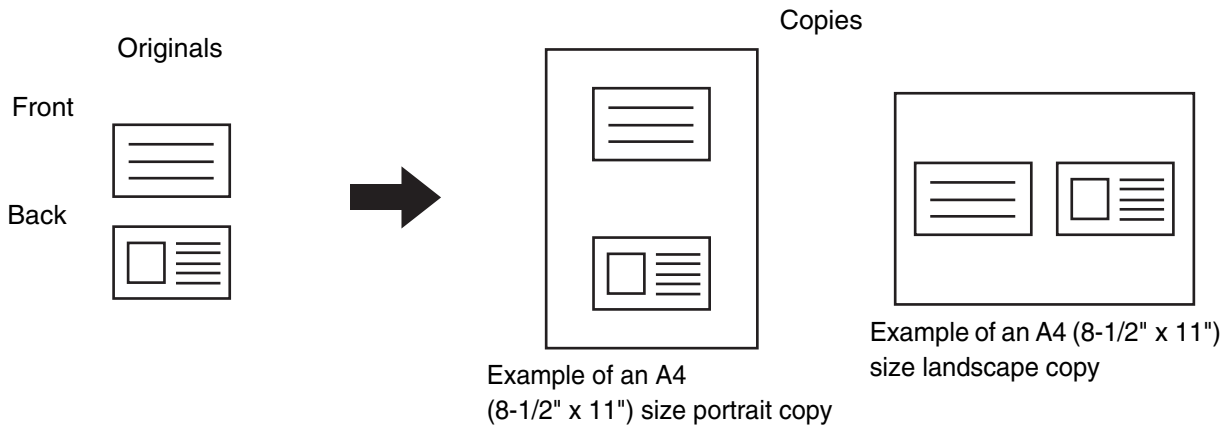

## Select the paper to be used for card shot.

Select the paper as explained in "[PAPER TRAYS](#)" (page 2-11).

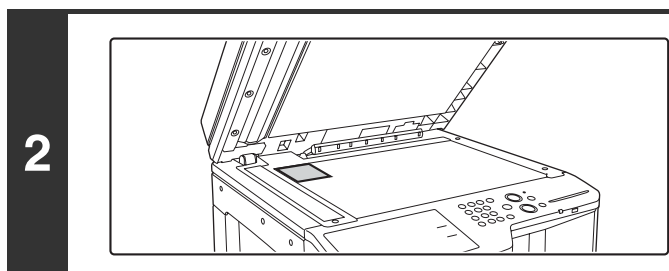

## Place the original face down on the document glass.

- 3
- Select the special modes.**
- (1) Touch the [Special Modes] key.
  - (2) Touch the [Card Shot] key.
- 👉 [Special modes menu \(1st screen\)](#) (page 2-41)

4

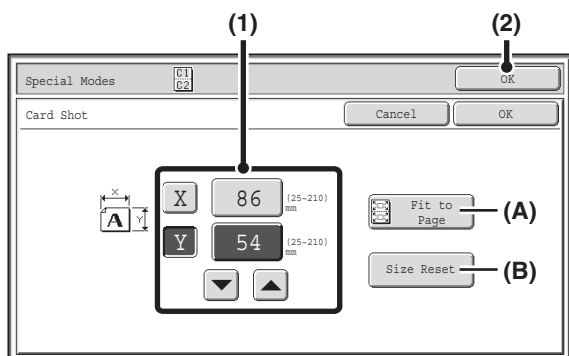

**Select card shot settings.**

**(1) Enter the original size.**

With the [X] key highlighted, enter the X (horizontal) dimension of the original with the keys. Touch the [Y] key and enter the Y (vertical) dimension of the original with the keys. You can also directly touch a numeric value display key to change a number with the numeric keys.

(A) To enlarge or reduce the images to fit the paper based on the entered original size, touch the [Fit to Page] key.

(B) The [Size Reset] key can be pressed to return the horizontal and vertical dimensions to the values set in "Card Shot Settings" in the system settings (administrator).

**(2) Touch the [OK] key.**

You will return to the base screen of copy mode. Make sure that the entered dimensions appear in the [Original] key.

5

**Press the [COLOUR START] key or the [BLACK & WHITE START] key to scan the front side of the card.**

**To cancel scanning...**  
Press the [STOP] key ().

6

**Turn the card over and press the [COLOUR START] key or the [BLACK & WHITE START] key to scan the reverse side of the card.**

Use the same [START] key that you used for the front side of the card.

**To cancel scanning...**  
Press the [STOP] key ().

7

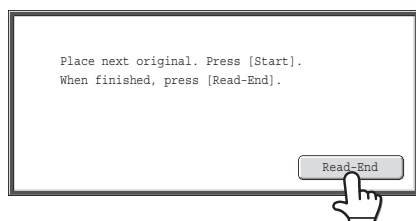

**Touch the [Read-End] key.**

Copying will begin.

**To cancel copying...**  
Press the [STOP] key ().



- The original must be placed on the document glass.
- Copying is only possible on standard size paper.
- XY Zoom cannot be used when using this function.
- The image cannot be rotated when using this function.

**To cancel card shot...**

Touch the [Cancel] key in the screen of step 4.

**System Settings (Administrator): Card Shot Settings**

This is used to set the values to which the size returns when the [Size Reset] key is pressed. 25 mm to 210 mm (1" to 8-1/2") can be entered for both the horizontal and vertical dimensions.

The factory default settings are 86 mm (3-3/8") for X (the width) and 54 mm (2-1/8") for Y (the height).

# PRINTING THE DATE AND A STAMP ON COPIES (Stamp)

Use this function to print the date, a stamp, the page number, and text on copies. In addition, specific text can be added to a copy as a watermark. (Watermark)\*

Six printing positions are available: top left, top centre, top right, bottom left, bottom centre, and bottom right.

The printing positions are separated into areas that are used for the date, page number and text (A below), and areas that are used for a stamp (B below). The watermark is printed at the centre of the paper.

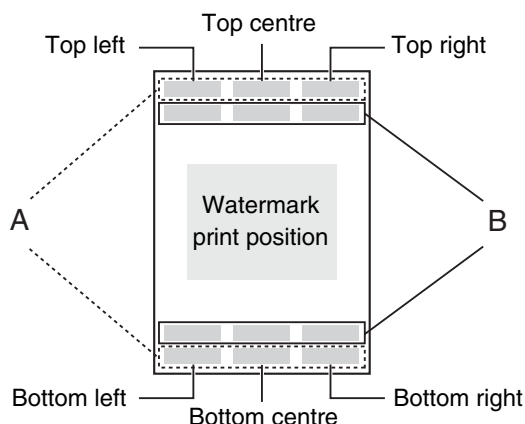

Stamp	Print area	Maximum number of positions
Date	A	1 position only
Stamp	B	6 positions
Page Numbering	A	1 position only
Text	A	6 positions
Watermark*	Centre of paper	—

\* On the MX-2314N, the productivity kit is required.

-  If the selected stamp content of one position overlaps the stamp content of another position, priority will be given in the following order: watermark, right side, left side, centre. Content that is hidden due to overlapping will not be printed.
- Text will be printed at the preset size regardless of the copy ratio or paper size setting.
- Text will be printed at the preset exposure regardless of the exposure setting.
- Depending on the size of the paper, some printed content may be cut off or shifted out of position.

## When used in combination with other special modes

When Stamp is used in combination with the following special modes, the special modes are reflected in the stamp content.



Special Modes	Printing
Margin Shift	Together with the image, the stamp content is shifted the amount of the margin width.
Tab Copy Centring	Unlike a copy image that moves, the image will be printed in the position set in the stamp.
Dual Page Copy Card Shot	The stamp is printed on each copy sheet.
Multi Shot	The print content is printed on each original page.
Pamphlet Copy Book Copy	The stamp is printed on each page of the resulting pamphlet or book.
Covers/Inserts	Use the stamp settings to select whether or not the item is printed on inserted covers and inserts.

# GENERAL PROCEDURE FOR USING STAMP

To select stamp settings, follow the steps below.

**1 Place the original.**  
Place the original face up in the document feeder tray, or face down on the document glass.

**2 Select the special modes.**

- (1) Touch the [Special Modes] key.
- (2) Touch the   keys to switch through the screens.
- (3) Touch the [Stamp] key.

 [Special modes menu \(2nd screen\)](#) (page 2-42)

**3 Select the print position.**

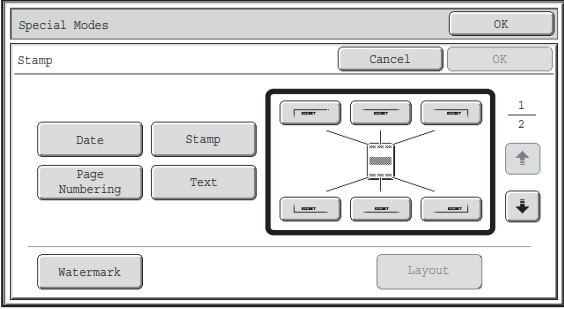

Select from 6 positions: top left, top centre, top right, bottom left, bottom centre, bottom right.



You can also skip this step and go directly to the next step. In this case, the stamp items will be printed in the following positions:

**Date:** Top right                      **Stamp:** Top left  
**Page number:** Bottom centre      **Text:** Top left

The position of a watermark cannot be selected. Proceed to the next step.

**Print positions**

The keys that show the print positions will appear as follows depending on the state of the settings.

	Not selected, stamp setting has not been selected.
	Selected during selection of the stamp setting.
	Not available, stamp setting has already been allocated.

The above key is the top left key. The appearance of each key varies depending on the position of the key.

-  "Date" and "Page Numbering" cannot be selected in multiple positions. If the [Date] key or [Page Numbering] key is touched when "Date" or "Page Numbering" has already been selected for a position, a message will appear asking you if you wish to move that item to the selected position. To move the item, touch the [Yes] key. Otherwise, press the [No] key.
- If you attempt to set "Date", "Text", or "Page Numbering" in a position where one of these items is already set, a message will appear. To change the previously selected item to the new item, touch the [Yes] key. To keep the previous item, touch the [No] key.

4

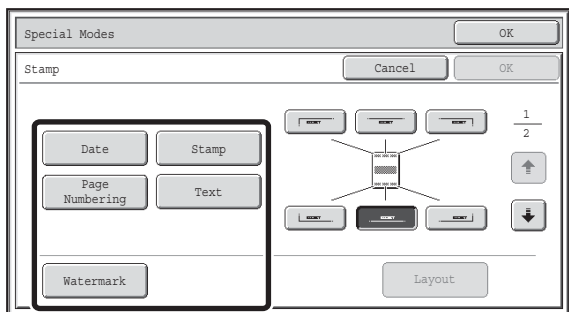

### Select Stamp.

For detailed information on each of the stamp items, see the following sections:

- Date:** [ADDING THE DATE TO COPIES \(Date\)](#) (page 2-88)
- Stamp:** [STAMPING COPIES \(Stamp\)](#) (page 2-90)
- Page numbering:** [PRINTING PAGE NUMBERS ON COPIES \(Page Numbering\)](#) (page 2-92)
- Text:** [PRINTING TEXT ON COPIES \(Text\)](#) (page 2-96)
- Watermark:** [ADDING A WATERMARK TO A COPY \(Watermark\)](#) (page 2-102)

5

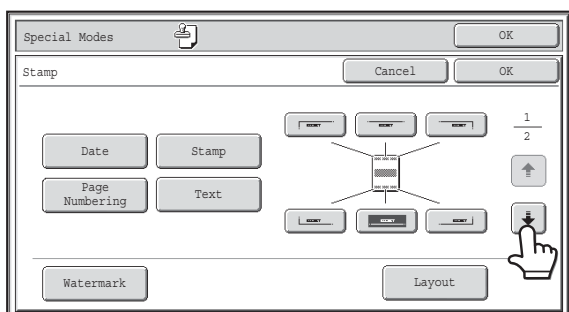

When you have finished selecting stamp settings, touch the key.

6

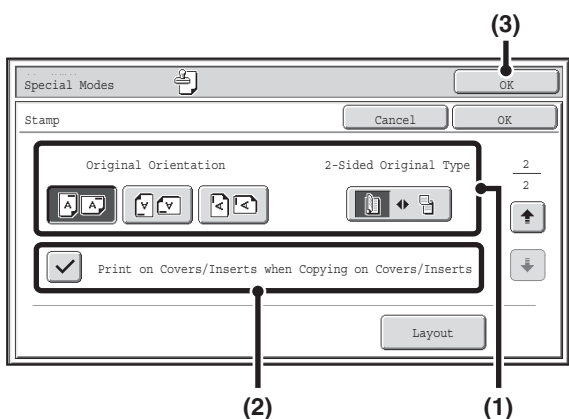

### Select settings for the original and covers/inserts.

(1) Touch the [Original Orientation] key and specify the orientation of the placed original.

If 2-sided originals have been placed, touch the key and specify the binding position (booklet binding or tablet binding) of the originals.

(2) Select stamp settings for covers/inserts.

If you do not want to print the stamp items on covers/inserts, touch the checkbox to remove the checkmark .

(3) Touch the [OK] key.

You will return to the base screen of copy mode. To edit a stamp position or delete a stamp item, touch the [Layout] key.

[CHECKING THE STAMP LAYOUT \(Layout\)](#) (page 2-100)



- When copying on covers/inserts is not selected, printing will not take place even if a checkmark appears.
- This setting cannot be selected if insertion of covers and inserts is disabled in the system settings (administrator).

7

**Press the [COLOUR START] key or the [BLACK & WHITE START] key.**

Copying will begin.

If you are using the document glass to copy multiple original pages, copying will take place as you scan each original. If you have selected sort mode, change originals and press the [START] key. Repeat until all pages have been scanned and then touch the [Read-End] key. (For the second original and following originals, use the same [START] key as you did for the first original.



- If you selected printing in colour, press the [COLOUR START] key. Even if a colour is selected, pressing the [BLACK & WHITE START] key will print the stamp items in black and white.
- If a colour print setting is selected, the copy will be counted as a full colour copy even if it is black & white.

**To cancel scanning and copying...**

Press the [STOP] key (⏹).

**To cancel Stamp...**

Touch the [Cancel] key in the screen of step 3.

# ADDING THE DATE TO COPIES (Date)

The date can be printed on copies. The position of the date, colour, format, and page (first page only or all pages) can be selected.

**Example: Printing APRIL 4, 2013 in the top right corner of the paper.**



1

## Touch the [Date] key in the stamp selection screen.

See steps 1 to 4 of "GENERAL PROCEDURE FOR USING STAMP" (page 2-85).

2

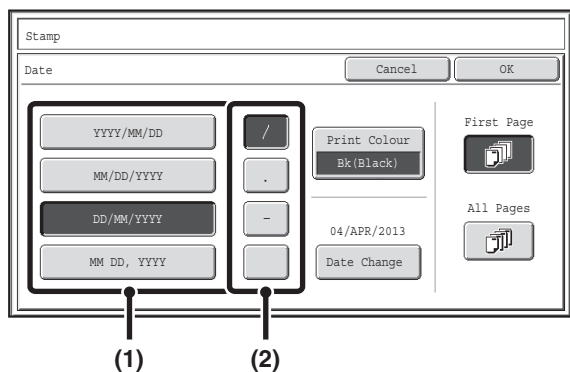

## Set the date format.

- (1) Touch the key that shows the desired date format.
- (2) If you selected [YYYY/MM/DD], [MM/DD/YYYY], or [DD/MM/YYYY], touch the [/], [.] , [-], or [ ] key to select the separator.

3

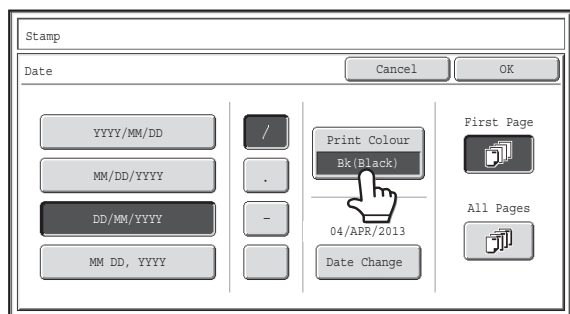

## Touch the [Print Colour] key and select the print colour.

Touch the desired colour and touch the [OK] key.

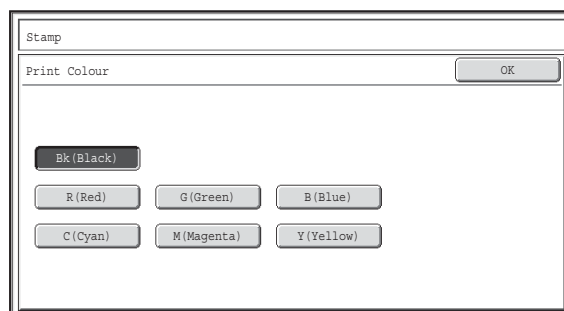

- If you selected a colour other than [Bk (Black)], press the [COLOUR START] key. Pressing the [BLACK & WHITE START] key will print the date in black and white.
- If the date is printed in colour on a black and white copy, the copy will be included in the full colour count.



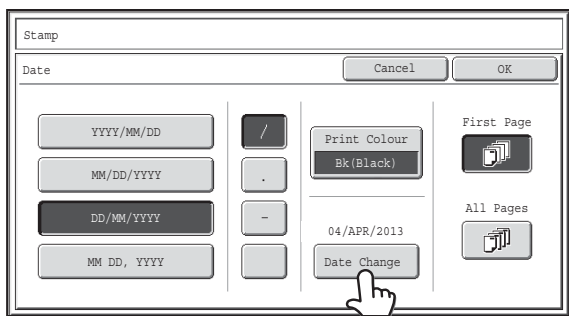

4

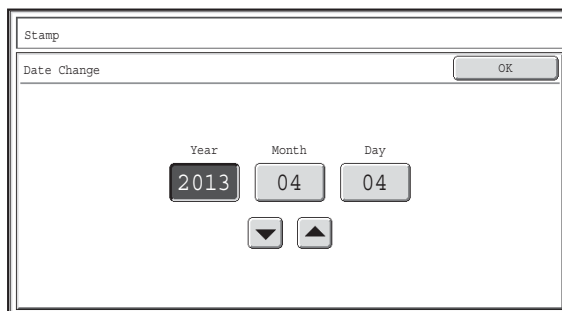

**Check the displayed date. If you need to change the date, touch the [Date Change] key.**

Set the date that you wish to use and touch the [OK] key.



As an alternative to touching the   keys, you can also directly touch the numeric value display key and change the value with the numeric keys.



- If you select a date that does not exist (such as Feb. 30), the [OK] key will be greyed out to prevent entry.
- Changing the date here will not change the date that is set in the machine using "Clock" in the system settings.

5

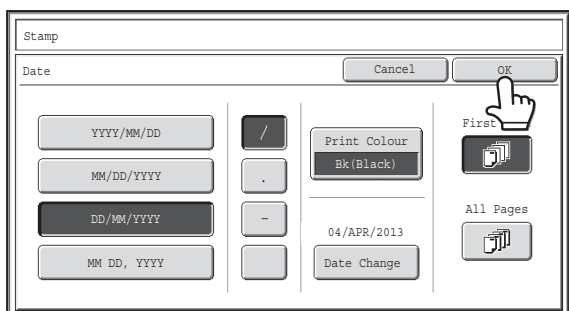

**Select the pages that the date will be printed on and touch the [OK] key.**

Select printing on the first page only, or printing on all pages. After touching the [OK] key, continue from step 5 of "[GENERAL PROCEDURE FOR USING STAMP](#)" (page 2-85) to complete the copy procedure.



**To cancel the date print setting...**

Touch the [Cancel] key in the screen of step 2.

# STAMPING COPIES (Stamp)

Text such as "CONFIDENTIAL" can be printed in white on a dark background as a "stamp" on copies. The position, colour, size, density, and pages (first page only or all pages) can be selected for a stamp.

## Printing "CONFIDENTIAL" in the top left corner of a copy



The following 12 selections are available for the stamp text.

CONFIDENTIAL	PRIORITY	PRELIMINARY	FINAL
FOR YOUR INFO.	DO NOT COPY	IMPORTANT	COPY
URGENT	DRAFT	TOP SECRET	PLEASE REPLY

Three levels can be selected for the density of the stamp background.  
 Seven colours can be selected for the stamp colour.  
 Two stamp sizes can be selected.

**1** Touch the [Stamp] key in the stamp selection screen.  
 See steps 1 to 4 of "[GENERAL PROCEDURE FOR USING STAMP](#)" (page 2-85).

**2**

**Touch the key of the stamp that you wish to use.**

3

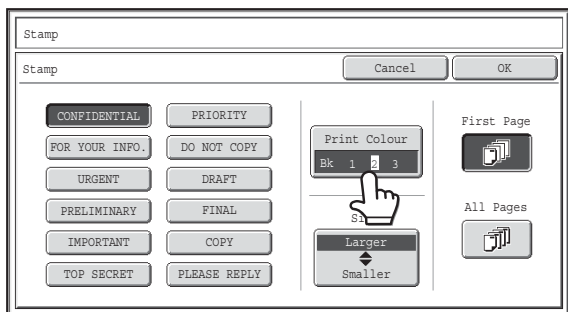

**Touch the [Print Colour] key and set the colour and density.**

Touch the colour that you wish to use. If you wish to darken the selected colour, touch the key. If you wish to lighten the selected colour, touch the key. When you have finished selecting the settings, touch the [OK] key.

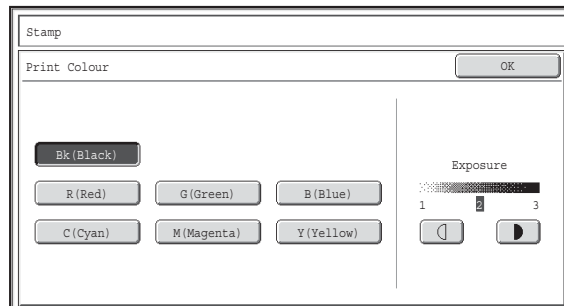

- If you selected a colour other than [Bk (Black)], press the [COLOUR START] key. Pressing the [BLACK & WHITE START] key will print the stamp in black and white.
- If the stamp is printed in colour on a black and white copy, the copy will be included in the full colour count.

4

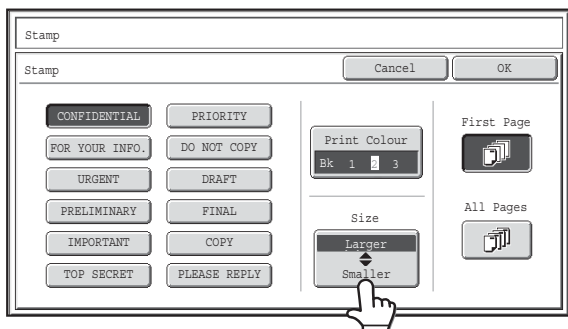

**Touch the [Larger] or [Smaller] key to select the size of the stamp.**

5

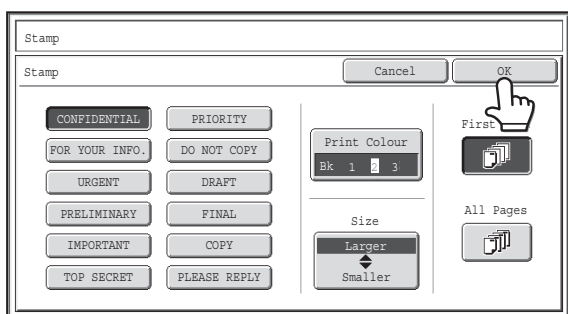

**Select the pages that the date will be printed on and touch the [OK] key.**

Select printing on the first page only, or printing on all pages. After touching the [OK] key, continue from step 5 of "GENERAL PROCEDURE FOR USING STAMP" (page 2-85) to complete the copy procedure.



The stamp text cannot be edited.



**To cancel a stamp setting...**  
Touch the [Cancel] key in the screen of step 2.

# PRINTING PAGE NUMBERS ON COPIES (Page Numbering)

Page numbers can be printed on copies.

The position, colour, format, and page number can be selected for page numbering.

Printing the page number at the bottom centre of the paper.

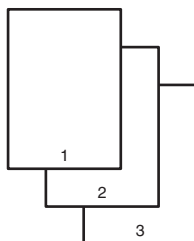

## 1 Touch the [Page Numbering] key in the stamp selection screen.

See steps 1 to 4 of "GENERAL PROCEDURE FOR USING STAMP" (page 2-85).

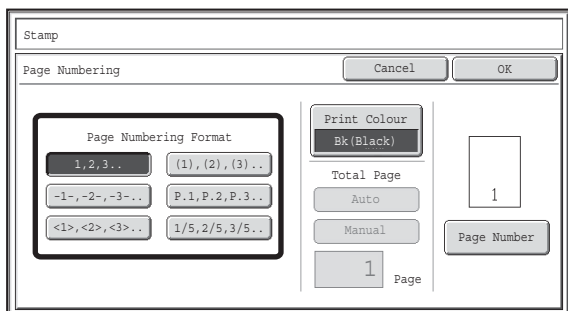

## Select a format for the page number.

If the [1/5, 2/5, 3/5] key is selected, "Page number / total pages" will be printed. "Auto" is initially selected for the total pages, which means that the number of scanned original pages is automatically set as the total pages. If you need to set the total pages manually, such as when a large number of originals are divided into sets for scanning, touch the [Manual] key to display the total pages entry screen.

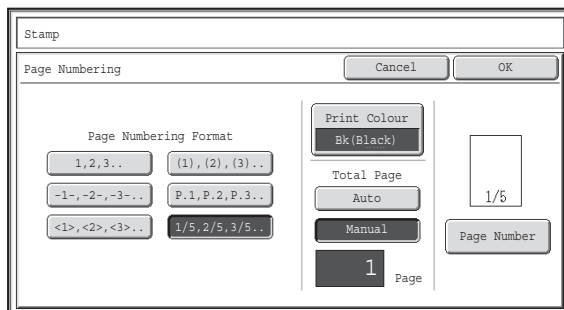

## 2

Enter the total pages (1 to 999) with the numeric keys and touch the [OK] key.

The [CLEAR] key (⊙) can be pressed to return the setting of the selected item to the default value. If you make a mistake, press the [CLEAR] key (⊙) and then enter the correct number.



- When 2-sided copying is performed, the total pages is the total number of sides of the paper. If the final page is blank, it is not counted. However, if a back cover will be added and the [Count Back Cover] checkbox is selected , the final page is counted. (See step 7.)
- When used in combination with "Dual Page Copy", "Multi Shot", or "Card Shot", the number of sides of the paper copied on is the total pages.
- When used in combination with "Pamphlet Copy" or "Book Copy", the total number of pages in the resulting pamphlet or booklet is the total pages.

3

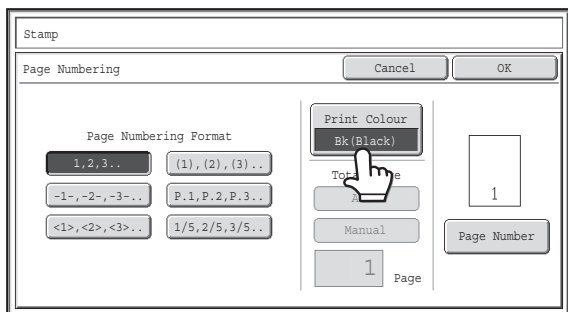

**Touch the [Print Colour] key.**

Touch the colour that you wish to use. When you have finished selecting the settings, touch the [OK] key.

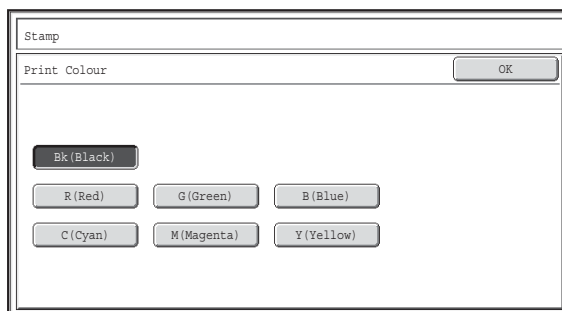

- If you selected a colour other than [Bk (Black)], press the [COLOUR START] key. Pressing the [BLACK & WHITE START] key will print the page numbers in black and white.
- If page numbers are printed in colour on black and white copies, the copies will be included in the full colour count.

4

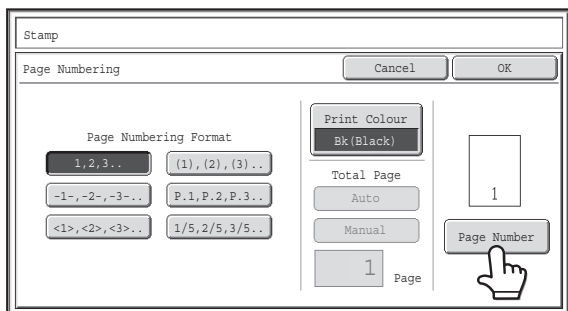

**To configure page number settings, touch the [Page Number] key.**

If you do not need to configure page number settings, go to step 9.

5

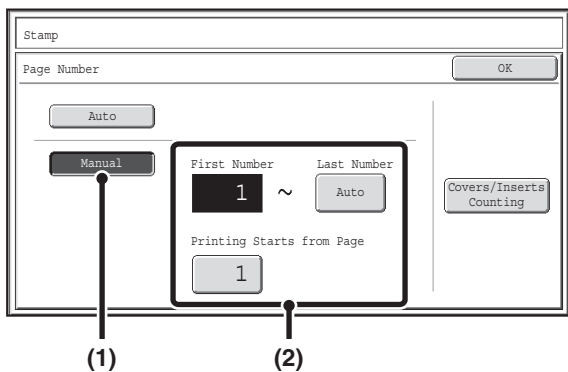

**Select page number settings.**

- (1) Touch the [Manual] key.
- (2) Set the first number, the last number, and the "Printing Starts from Page" number.

Touch each key and enter a number with the numeric keys (1 to 999).

The [CLEAR] key (Ⓢ) can be pressed to return the setting of the selected item to the default value. If you make a mistake, press the [CLEAR] key (Ⓢ) and then enter the correct number.



- A "Last Number" smaller than the "First Number" cannot be set.
- The "Last Number" is initially set to "Auto", which means that page numbers are automatically printed through the last page based on the "First Number" and "Printing Start from Page" settings.
- If the "Last Number" is set to a number smaller than the "Total Pages", page numbers are not printed on pages after the page set as the "Last Number".
- "Printing Starts from Page" is used to set the page number from which you want to begin printing page numbers. For example, if "3" is set and 1-sided copying is being performed, page numbers will be printed beginning from the 3rd copy sheet (the 3rd original page). If 2-sided copying is being performed, page numbers will be printed beginning from the front side of the 2nd copy sheet (the 3rd original page).

6

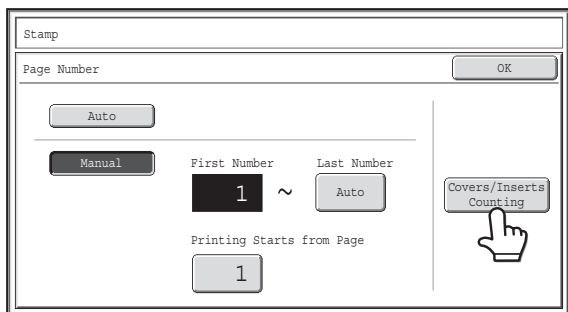

If covers/inserts will be inserted, touch the [Covers/Inserts Counting] key if you want to include the covers/inserts in the page number count and want page numbers printed on the covers/inserts.

7

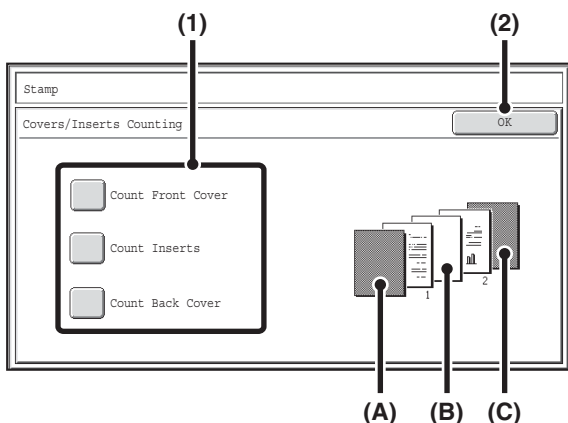

Touch each item that you want counted in the page numbers so that a checkmark appears , and then touch the [OK] key.

Items with a checkmark  will be reflected in the print image on the right side of the screen.

(A): Front cover image

(B): Insert image

(C): Back cover image



- When the checkboxes are selected , each inserted sheet of paper (front cover, insert, or back cover) will be counted as one page in the case of 1-sided copying, or two pages in the case of 2-sided copying. However, when the body sheets are 1-sided copies and the inserted sheets are 2-sided copies, each body sheet is counted as one page and each inserted sheet is counted as two pages.
- Page numbers are printed on covers/inserts if the covers/inserts are counted and if they are copied on.

8

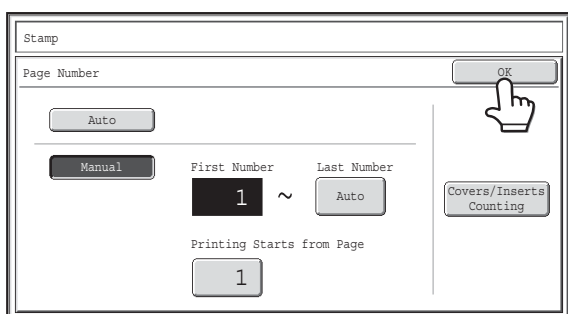

Touch the [OK] key.

9

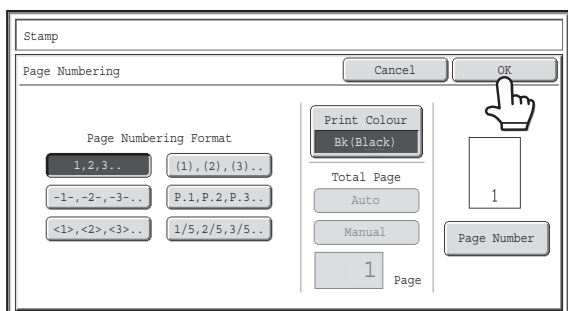

Touch the [OK] key.

After touching the [OK] key, continue from step 5 of "GENERAL PROCEDURE FOR USING STAMP" (page 2-85) to complete the copy procedure.

- When Page Numbering is selected, copying in group mode is not possible. The mode automatically changes to sort mode.
- When the page number printing position is set to the right side or left side and pamphlet copy or book copy is used, the print position is changed so that the page numbers always appear on the outer side of each opened page (the left and right sides of the opened pages). If a stamp is set in the area where page numbering is set, the position of the stamp changes in the same way as the page number.

If another stamp item is set in this changing position, the page numbers will alternate sides with this stamp item. A stamp item that is in a position not affected by the changing page number position will be printed in its original set position.

Example: When four pages are copied using pamphlet copy and the page number format is "1, 2, 3...", the result is as follows:

In this example, the page number is set at the bottom of the page and the date is set at the top, and thus the date does not move.

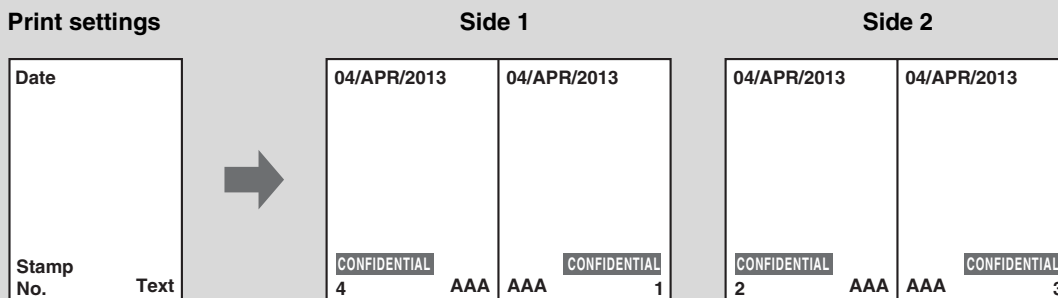

**To cancel the page numbering setting...**  
 Touch the [Cancel] key in the screen of step 2.

# PRINTING TEXT ON COPIES (Text)

Entered text can be printed on copies. Up to 30 frequently used text strings can be stored.

**Example: Printing "April 2013 Planning Meeting" in the top left corner of the paper**

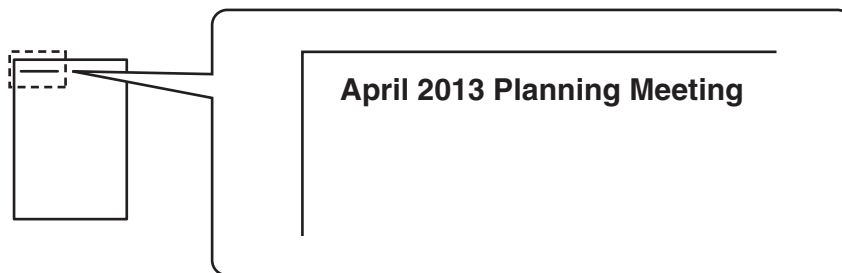

**1** Touch the [Text] key in the stamp selection screen.  
 See steps 1 to 4 of "[GENERAL PROCEDURE FOR USING STAMP](#)" (page 2-85).

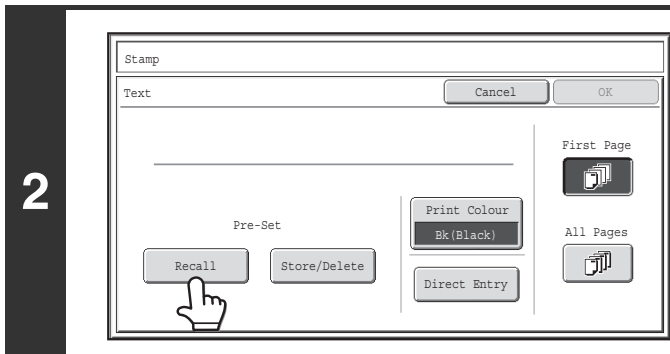

## Touch the [Recall] key.

The [Direct Entry] key can be touched to display the text entry screen. When all characters have been entered, touch the [OK] key.

To store or delete a text string, touch the [Store/Delete] key.  
 ➔ [Storing, editing, and deleting text strings](#) (page 2-98)

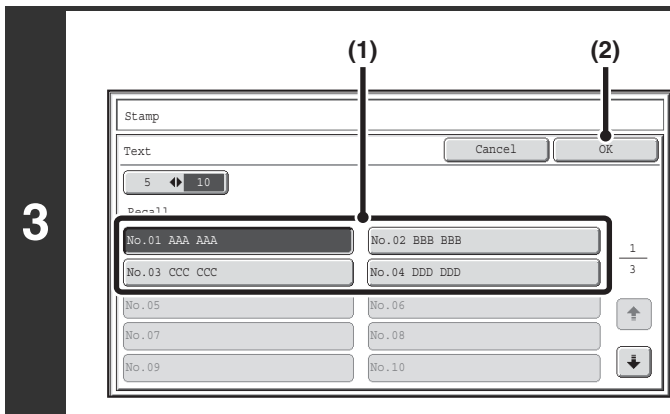

## Specify the text to be printed.

**(1) Touch the text string that you wish to select.**

You can touch the [5 ◀▶ 10] key to switch the number of keys displayed in the screen between 5 and 10. When 5-key display is selected, the entire text string appears in each key.

**(2) Touch the [OK] key.**



4

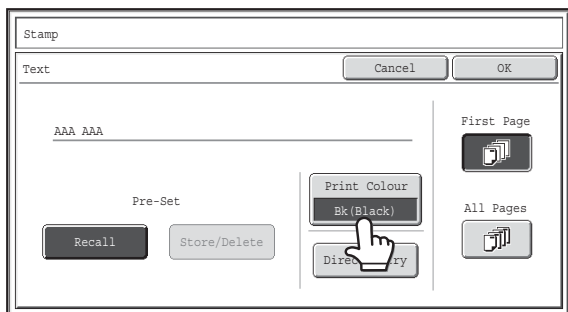

**Touch the [Print Colour] key.**

Touch the colour that you wish to use. When you have finished selecting the settings, touch the [OK] key.

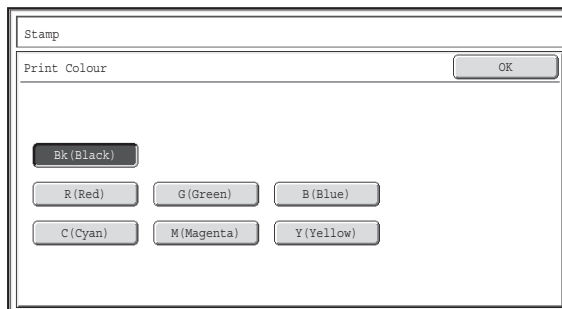

- If you selected a colour other than [Bk (Black)], press the [COLOUR START] key. Pressing the [BLACK & WHITE START] key will print the page numbers in black and white.
- If the text is printed in colour on a black and white copies, the copies will be included in the full colour count.

5



**Select the pages to be printed on and touch the [OK] key.**

Select printing on the first page only, or printing on all pages. After touching the [OK] key, continue from step 5 of "GENERAL PROCEDURE FOR USING STAMP" (page 2-85) to complete the copy procedure.



Text settings can also be configured in the Web pages. Click [Application Settings], [Copy settings] and then [Text Settings (Stamp)] in the Web page menu.



**To cancel a text setting...**  
Touch the [Cancel] key in the screen of step 2.

# Storing, editing, and deleting text strings

## 1 Touch the [Text] key in the stamp selection screen.

See steps 1 to 4 of "GENERAL PROCEDURE FOR USING STAMP" (page 2-85).

## 2

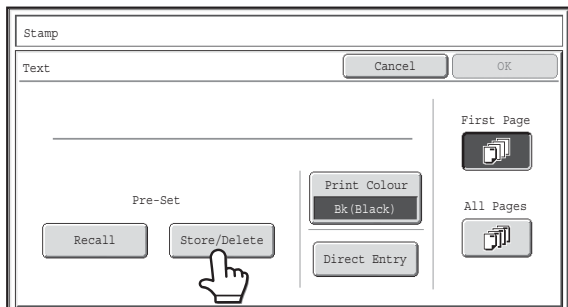

Touch the [Store/Delete] key.

## Store a text string, or edit/delete a stored text string.

- To store a text string, touch a key with no text stored. A text entry screen will appear. A maximum of 50 characters can be entered. When you have finished entering the text, touch the [OK] key. The text entry screen will close.
- To edit or delete a text string, follow the instructions below.

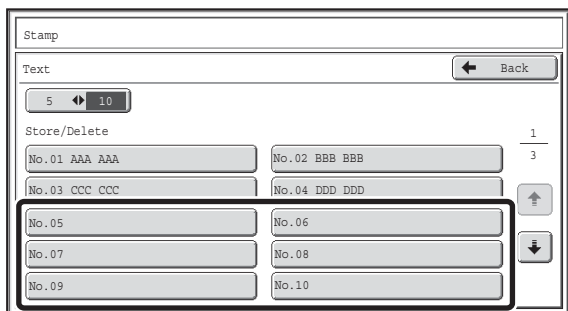

## 3

### To edit or delete a text string...

- When the key with the text string is touched, the following screen appears. When the [Amend] key is touched, a text entry screen appears. The stored text string appears in the text entry screen. Edit the text. When you have finished entering the text, touch the [OK] key. The text entry screen will close.
- When the [Delete] key is touched, the stored text is deleted.

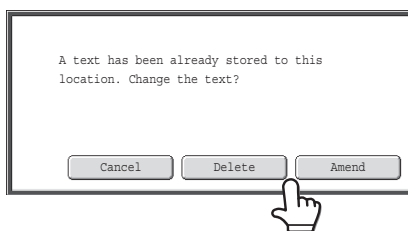

- Text settings can also be configured in the Web pages. Click [Application Settings], [Copy settings] and then [Text Settings (Stamp)] in the Web page menu.

4

The screenshot shows a screen titled "Stamp". At the top, there is a "Text" field with a "Back" button to its right. Below this is a numeric keypad showing "5" and "10". Underneath is a "Store/Delete" section with a list of 10 numbered text strings: "No.01 AAA AAA", "No.02 BBB BBB", "No.03 CCC CCC", "No.04", "No.05", "No.06", "No.07", "No.08", "No.09", and "No.10". To the right of the list are up and down arrow buttons. A hand icon is pointing to the "Back" button.

### Touch the [Back] key.

You will return to the screen of step 2.

To copy using a stored text string, continue from step 2 of "[PRINTING TEXT ON COPIES \(Text\)](#)" (page 2-96).

# CHECKING THE STAMP LAYOUT (Layout)

After stamp items have been selected, you can check the print layout, change the print position, and delete stamp items.

1

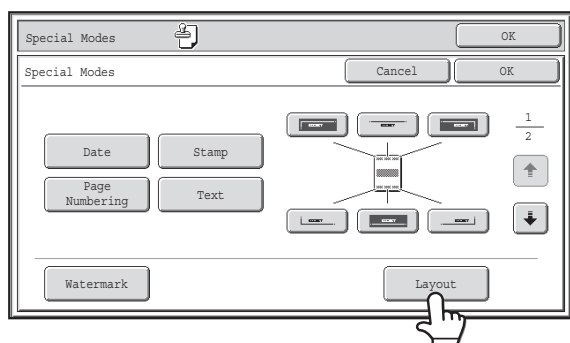

Touch the [Layout] key.



The [Layout] key can only be touched when stamp items have been selected.

2

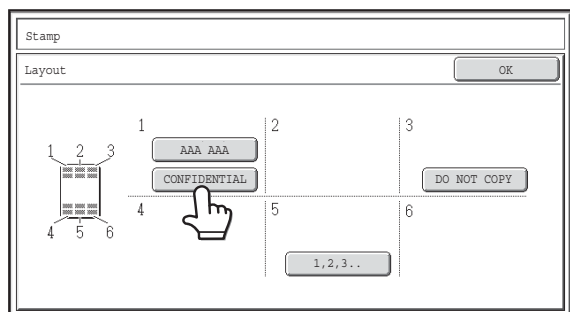

If the layout is correct, touch the [OK] key.

Touch the key of the stamp item that you want to delete or whose position you want to change.



A maximum of 14 characters appear in each key.

3

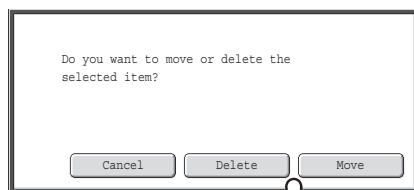

To change the position of the item, touch the [Move] key. To delete the item, touch the [Delete] key.

- If the [Move] key is touched, a screen for selecting the destination position appears.
- If the [Delete] key is touched, the item is deleted. (Go to step 6.)

4

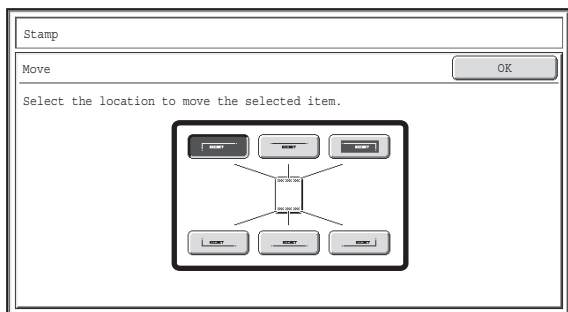

**Touch the key of the desired destination position.**

The touched position key is highlighted and the print position changes.

The keys that show the print positions will appear as follows depending on the state of the settings.

	Not selected, stamp setting has not been selected.
	Selected during selection of the stamp setting.
	Not available, stamp setting has already been allocated.

The above key is the top left key. The appearance of each key varies depending on the position of the key.



If you wish to swap the position of the selected stamp item with the position of another stamp item, temporarily move either one of the items to an unoccupied position and then switch the print positions.

5

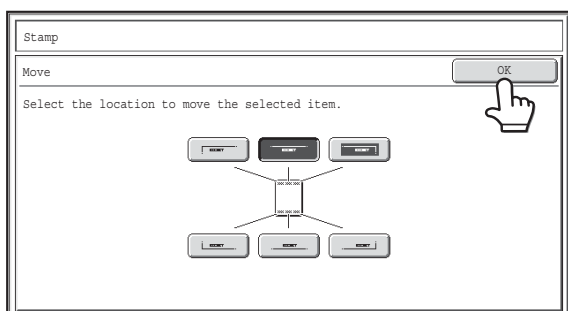

**Touch the [OK] key.**

If you attempt to move the stamp item to a position that is already occupied by another stamp item, a message will appear asking you if you wish to overwrite the other stamp item. To overwrite the other stamp item, touch the [Yes] key. To cancel the move, touch the [No] key.

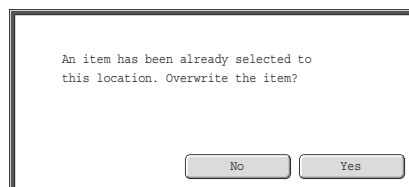

6

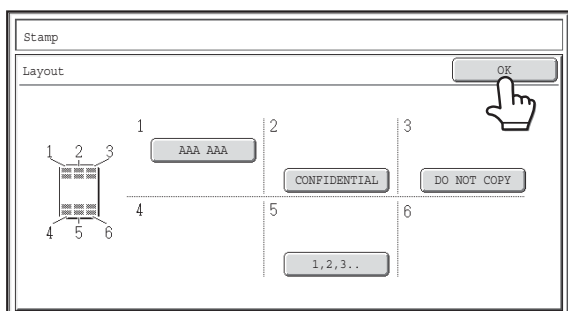

**Touch the [OK] key.**

# ADDING A WATERMARK TO A COPY (Watermark)

(On the MX-2314N, the productivity kit is required.)

When making a copy, specific text can be added to the copy as a watermark. The colour, density, angle, and pages (first page only or all pages) can be selected for a watermark. The watermark is printed at the centre of the paper.

## Printing "CONFIDENTIAL" on the paper



The following 12 selections are available for the stamp text.

CONFIDENTIAL	PRIORITY	PRELIMINARY	FINAL
FOR YOUR INFO.	DO NOT COPY	IMPORTANT	COPY
URGENT	DRAFT	TOP SECRET	PLEASE REPLY

Three levels can be selected for the density of the watermark.

Seven colours can be selected for the watermark colour.

The angle of a watermark can be selected in the range +90 degrees to -90 degrees in increments of 45 degrees.

1

### Touch the [Watermark] key in the stamp selection screen.

See steps 1 to 4 of "[GENERAL PROCEDURE FOR USING STAMP](#)" (page 2-85).

2

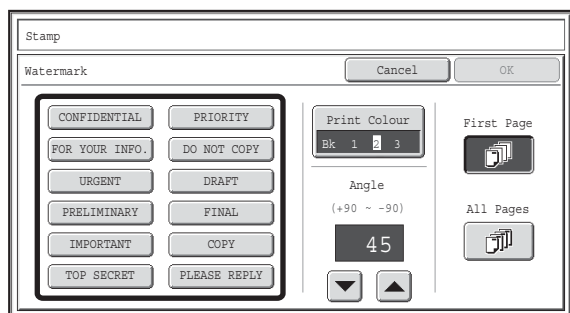

Touch the key of the watermark that you wish to use.

3

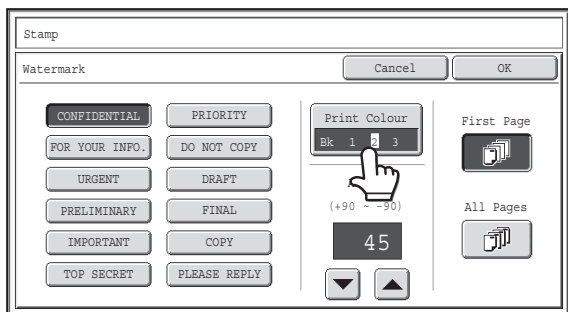

**Touch the [Print Colour] key and set the colour and density.**

Touch the colour that you wish to use.

If you wish to darken the selected colour, touch the key. If you wish to lighten the selected colour, touch the key. When you have finished selecting the settings, touch the [OK] key.

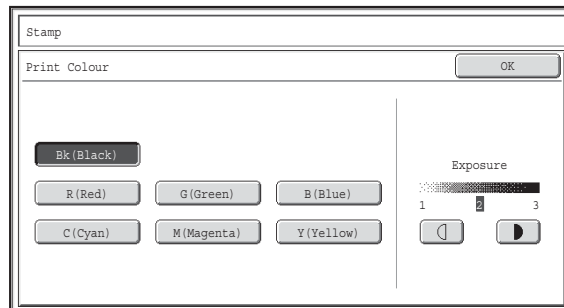

- If you selected a colour other than [Bk (Black)], press the [COLOUR START] key. Pressing the [BLACK & WHITE START] key will print the stamp in black and white.
- If the stamp is printed in colour on a black and white copy, the copy will be included in the full colour count.

4

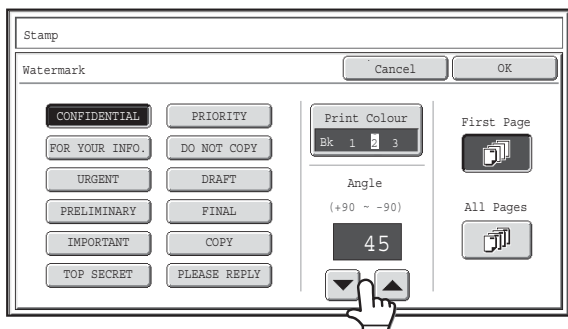

**Touch the keys to set the angle of the watermark.**

5

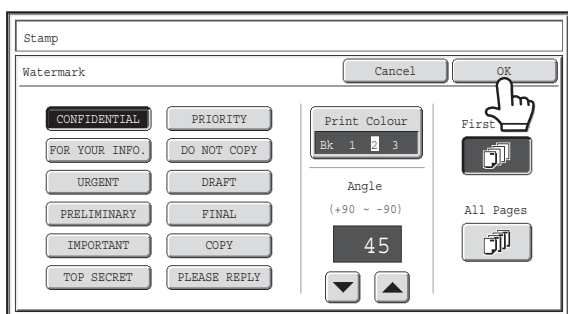

**Select the pages that the watermark will be printed on and touch the [OK] key.**

Select printing on the first page only, or printing on all pages. After touching the [OK] key, continue from step 5 of "[GENERAL PROCEDURE FOR USING STAMP](#)" (page 2-85) to complete the copy procedure.



The watermark text cannot be edited.



**To cancel a watermark setting...**

Touch the [Cancel] key in the screen of step 2.

# [Image Edit] KEY

When the [Image Edit] key is touched in the 2nd special modes menu screen, the image edit menu screen opens.

## Image edit menu screen

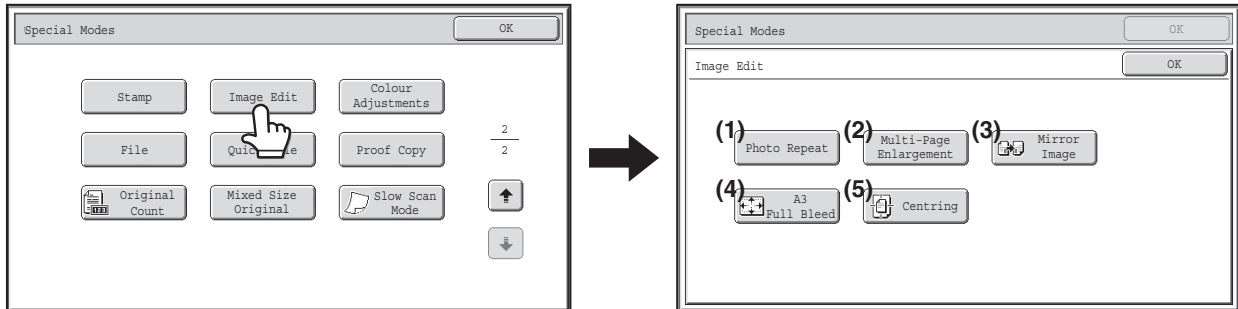

- (1) **[Photo Repeat] key**  
 ⓘ REPEATING PHOTOS ON A COPY (Photo Repeat) (page 2-105)
- (2) **[Multi-Page Enlargement] key**  
 ⓘ CREATING A LARGE POSTER (Multi-Page Enlargement) (page 2-107)
- (3) **[Mirror Image] key**  
 ⓘ REVERSING THE IMAGE (Mirror Image) (page 2-110)
- (4) **[A3 Full Bleed] key ([11x17 Full Bleed] key)**  
 ⓘ COPYING A3 (11" x 17") ORIGINALS WITH NO EDGE CUT-OFF (A3 (11" x 17") Full Bleed) (page 2-111)
- (5) **[Centring] key**  
 ⓘ COPYING IN THE CENTRE OF THE PAPER (Centring) (page 2-113)



# REPEATING PHOTOS ON A COPY (Photo Repeat)

Photo Repeat is used to create repeated images of a photo-size original (130 mm x 90 mm size, 100 mm x 150 mm size, 70 mm x 100 mm size, 65 mm x 70 mm size or 57 mm x 100 mm size (3" x 5" size, 5" x 7" size, 2-1/2" x 4" size, 2-1/2" x 2-1/2" size or 2-1/8" x 3-5/8" size)) on a single sheet of copy paper as shown below. Up to 24 images (when the image is 65 mm x 70 mm size (2-1/2" x 2-1/2" size)) can be repeated on a single sheet of paper.

- Original sizes up to 130 mm x 90 mm (3" x 5")

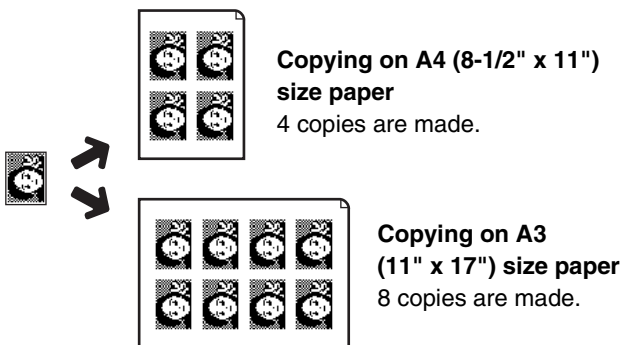

- Original sizes up to 100 mm x 150 mm (5" x 7")

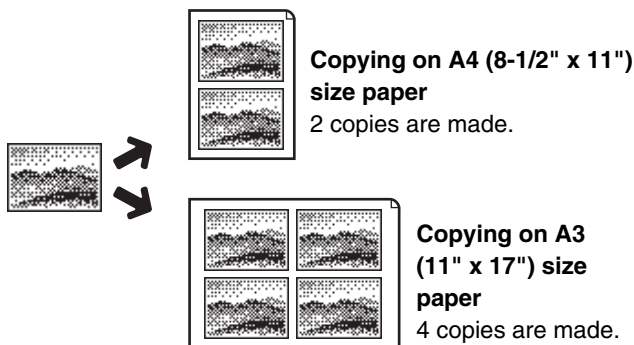

- Original sizes up to 70 mm x 100 mm (2-1/2" x 4")

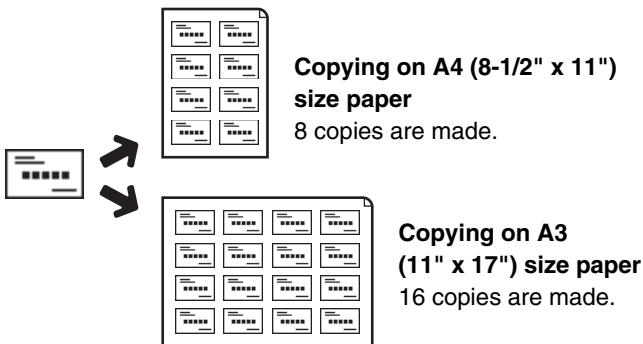

- Original sizes up to 65 mm x 70 mm (2-1/2" x 2-1/2")

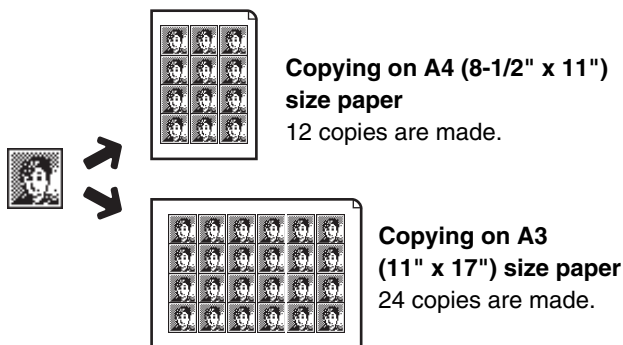

- Original sizes up to 57 mm x 100 mm (2-1/8" x 3-5/8")

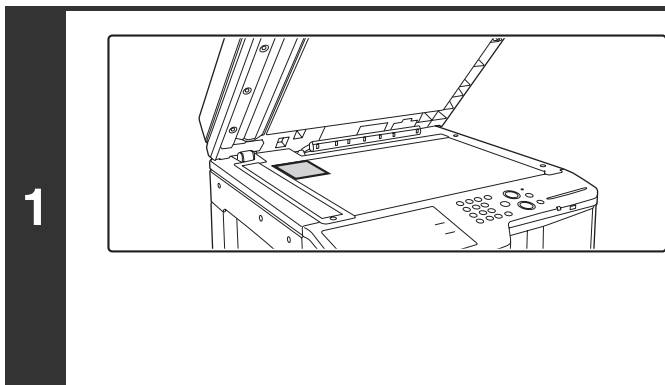



## Place the original face down on the document glass.

- When placing a 130 mm x 90 mm, 100 mm x 150 mm, 70 mm x 100 mm, 65 mm x 70 mm or 57 mm x 100 mm (3" x 5", 5" x 7", 2-1/2" x 4", 2-1/2" x 2-1/2" or 2-1/8" x 3-5/8") photo size original, place the original with the long side aligned against the left side of the document glass.
- When placing a business card size original, place the original with the long side aligned against the far side of the document glass.

1

2

## Select the special modes.

- (1) Touch the [Special Modes] key.
- (2) Touch the   keys to switch through the screens.
- (3) Touch the [Image Edit] key.
- (4) Touch the [Photo Repeat] key.

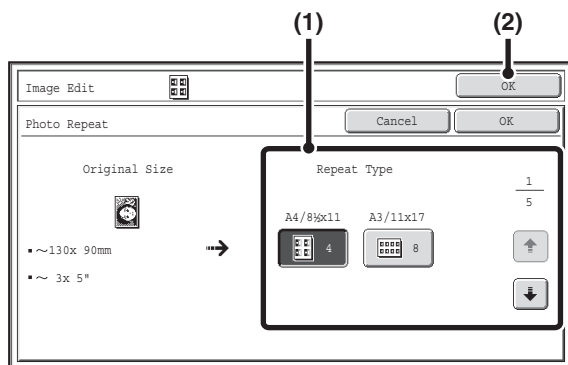

 [Image Edit] KEY (page 2-104)

3



## Select Photo Repeat settings.

- (1) Touch the key showing the original type and paper size combination that you want to use.

Touch the   keys to switch through the screens and touch the desired repeat type key (A4 or A3 (8-1/2" x 11" or 11" x 17")).

- (2) Touch the [OK] key.

You will return to the special modes screen. Touch the [OK] key to return to the base screen of copy mode.



When making repeat copies of a business card size original (up to 57 mm x 100 mm (2-1/8" x 3-5/8")), only A4 (8-1/2" x 11") can be selected for the paper size.

4

## Press the [COLOUR START] key or the [BLACK & WHITE START] key.

Copying will begin.

If you have selected sort mode, change originals and press the [START] key. Repeat until all pages have been scanned and then touch the [Read-End] key. (For the second original and following originals, use the same [START] key as you did for the first original.)



### To cancel scanning and copying...

Press the [STOP] key (.



- The original must be placed on the document glass.
- Only A4 (8-1/2" x 11") or A3 (11" x 17") size paper can be used.
- The copy ratio is 100% when this function is used. (The ratio cannot be changed.) However, for a business card size original (up to 57 mm x 100 mm (2-1/8" x 3-5/8")), the images are reduced to 95%.



### To cancel the photo repeat setting...



Touch the [Cancel] key in the screen of step 3.

# CREATING A LARGE POSTER (Multi-Page Enlargement)

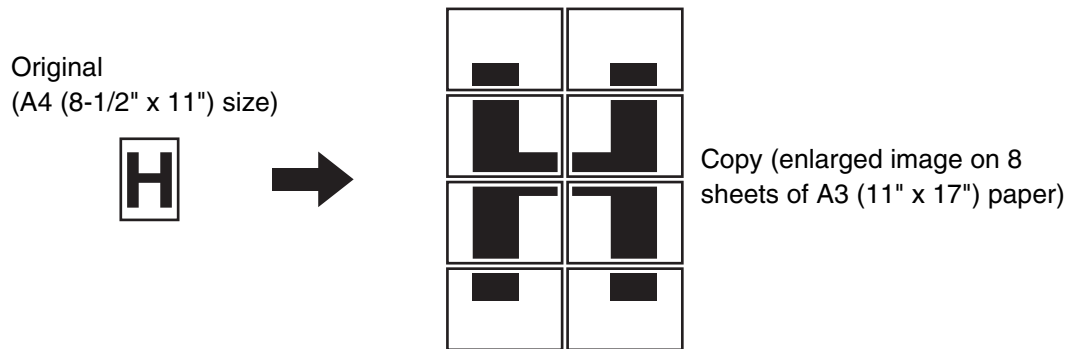
This function is used to enlarge an image of an original and print it as a composite image using multiple sheets of paper.



## Select the special modes.

- (1) Touch the [Special Modes] key.
- (2) Touch the   keys to switch through the screens.
- (3) Touch the [Image Edit] key.
- (4) Touch the [Multi-Page Enlargement] key.

 [\[Image Edit\] KEY](#) (page 2-104)

1

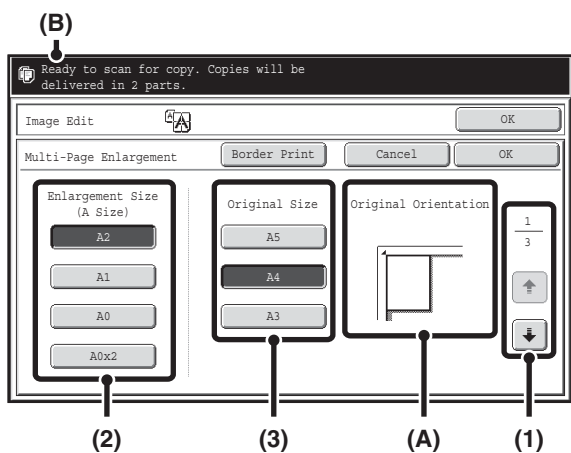

## Set the enlargement size and the original size.

### (1) Select the size system that you wish to use for multi-page enlargement.

Touch the keys to display the screen that shows the desired group of sizes.

- 1st screen: A system
- 2nd screen: B system
- 3rd screen: Inch system

### (2) Select the enlargement size.

### (3) Select the size of the original to be used.

A suitable original placement orientation (A) and the number of sheets of paper required for the enlarged image (B) are displayed based on the selected original size and enlargement size.

Check the placement orientation and number of sheets. The combinations of original sizes and enlargement sizes shown in the table at left are possible for multi-page enlargement.

2

Enlargement size ↔ Original size	
A system	A2 ↔ A3, A4, A5
	A1 ↔ A3, A4, A5
	A0 ↔ A3, A4
	A0 x 2* ↔ A3
B system	B3 ↔ B4, B5
	B2 ↔ B4, B5
	B1 ↔ B4, B5
	B0 ↔ B4
Inch system	22" x 17" ↔ 11" x 17", 8-1/2" x 14", 8-1/2" x 11"
	22" x 34" ↔ 11" x 17", 8-1/2" x 14", 8-1/2" x 11"
	34" x 44" ↔ 11" x 17", 8-1/2" x 14", 8-1/2" x 11"
	44" x 68" ↔ 11" x 17"

\* The size that is twice A0 size.



- An A size original cannot be enlarged to a B size, and a B size original cannot be enlarged to an A size.
- To print a borderline around the copy image, touch the [Border Print] key so that it is highlighted.

3

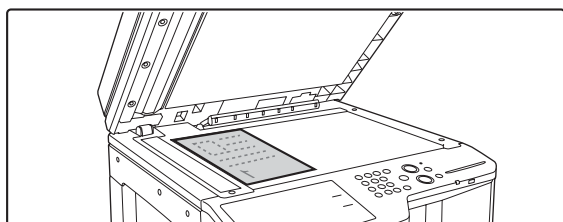

Place the original face down on the document glass in the orientation indicated in the screen.

4

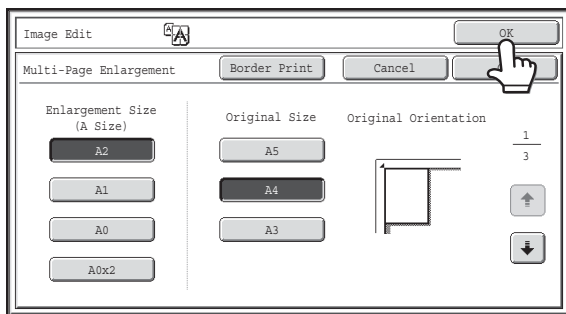

### Touch the [OK] key.

You will return to the special modes screen. Touch the [OK] key to return to the base screen of copy mode.

5

### Press the [COLOUR START] key or the [BLACK & WHITE START] key.

Copying will begin.

If you have selected sort mode, change originals and press the [START] key. Repeat until all pages have been scanned and then touch the [Read-End] key. (For the second original and following originals, use the same [START] key as you did for the first original.)



#### To cancel scanning and copying...

Press the [STOP] key (⏹).



- The original must be placed on the document glass.
- Overlap of sections of image
  - There will be a margin around the edges of each copy.
  - Areas for overlapping the copies will be created at the leading and trailing edges of each copy.
- If an original size is selected first, a message will appear indicating the enlargement sizes that can be selected. If an enlargement size is selected first, a message will appear indicating the original sizes that can be selected.
- If a combination of settings is selected for which multi-page enlargement is not possible, invalid selection beeps will sound.
- The paper size, number of sheets required for the enlarged image, and the ratio are automatically selected based on the selected original size and enlargement size.  
(The paper size and ratio cannot be selected manually.)
- If no paper trays have the size of paper that was automatically selected, "Load XXX paper" will appear. Change the paper in one of the trays or the bypass tray to the indicated size of paper.



#### To cancel the multi-page enlargement setting...

- Touch the [Cancel] key in the screen of step 2.  
Although the multi-page enlargement setting is cancelled, the ratio selected automatically is kept valid.
- To return the ratio to 100%...  
To return the ratio setting to 100%, touch the [Copy Ratio] key to display the ratio menu and then touch the [100%] key.

# REVERSING THE IMAGE (Mirror Image)

This feature is used to make a copy that is a mirror image of the original.

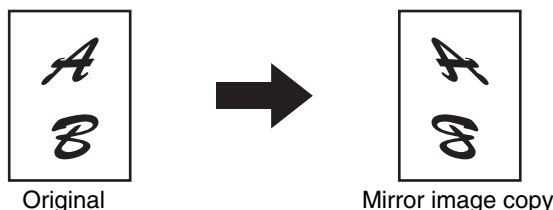

1

## Place the original.

Place the original face up in the document feeder tray, or face down on the document glass.

2

## Select the special modes.

(1) Touch the [Special Modes] key.

(2) Touch the   keys to switch through the screens.

(3) Touch the [Image Edit] key.

 [\[Image Edit\] KEY](#) (page 2-104)

3

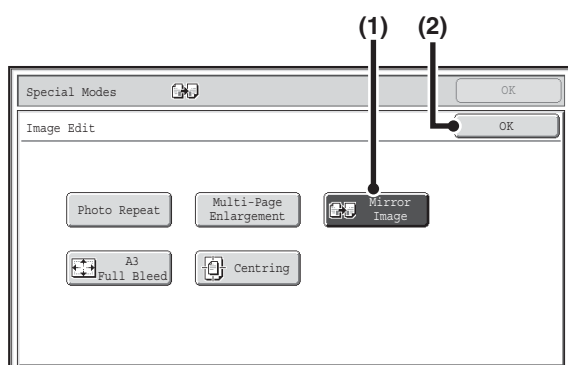

## Select Mirror Image.

(1) Touch the [Mirror Image] key so that it is highlighted.

(2) Touch the [OK] key.

You will return to the special modes screen. Touch the [OK] key to return to the base screen of copy mode.

4

## Press the [COLOUR START] key or the [BLACK & WHITE START] key.

Copying will begin.

If you are using the document glass to copy multiple original pages, copying will take place as you scan each original. If you have selected sort mode, change originals and press the [START] key. Repeat until all pages have been scanned and then touch the [Read-End] key. (For the second original and following originals, use the same [START] key as you did for the first original.)

 **To cancel scanning and copying...**  
Press the [STOP] key (.



### To cancel a mirror image setting...

Touch the [Mirror Image] key in the screen of step 3 so that it is not highlighted.

# COPYING A3 (11" x 17") ORIGINALS WITH NO EDGE CUT-OFF (A3 (11" x 17") Full Bleed)

This feature lets you copy an entire A3 (11" x 17") size original at full size with no image cut-off at the edges. A3W (12" x 18") size paper is used, which is slightly larger than A3 (11" x 17") size.

A3 (11" x 17") size original

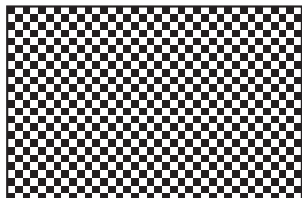

A3 (12" x 18") full bleed copy

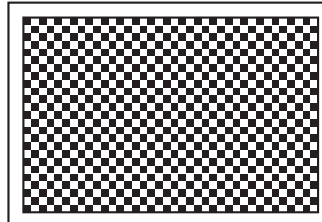

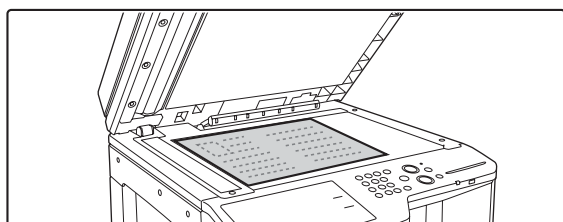

1



Place the original face down on the document glass.

2

Select the special modes.

- (1) Touch the [Special Modes] key.
- (2) Touch the   keys to switch through the screens.
- (3) Touch the [Image Edit] key.

 [\[Image Edit\] KEY](#) (page 2-104)

3

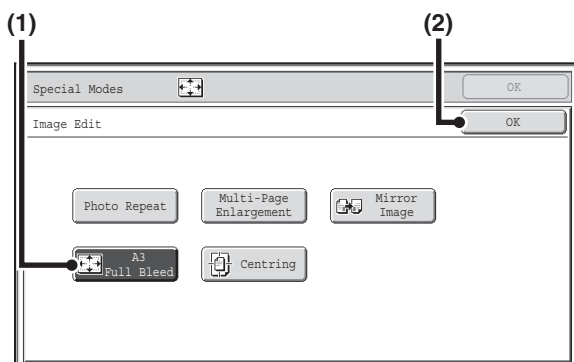

Select A3 (11x17) Full Bleed.

- (1) Touch the [A3 Full Bleed] or [11x17 Full Bleed] key so that it is highlighted.
- (2) Touch the [OK] key.

You will return to the special modes screen. Touch the [OK] key to return to the base screen of copy mode.

4

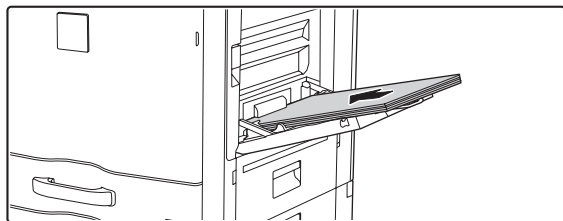

### Place A3W (12" x 18") paper in the bypass tray.

Pull out the extension tray, adjust the guides to the width of A3W (12" x 18") paper, and place the paper in the bypass tray. After loading the paper, configure the bypass tray settings as explained in "[MAKING COPIES USING THE BYPASS TRAY](#)" (page 2-38).

5

### Press the [COLOUR START] key or the [BLACK & WHITE START] key.

Copying will begin.

If you have selected sort mode, change originals and press the [START] key. Repeat until all pages have been scanned and then touch the [Read-End] key. (For the second original and following originals, use the same [START] key as you did for the first original.)



#### To cancel scanning and copying...

Press the [STOP] key (⏹).



- The original must be placed on the document glass.
- The copy ratio is 100% when this function is used. The ratio cannot be changed.
- The staple and punch function cannot be used.



#### To cancel A3 (11x17) Full Bleed...



Touch the [A3 Full Bleed] or [11x17 Full Bleed] key in the screen of step 3 so that it is not highlighted.



# COPYING IN THE CENTRE OF THE PAPER (Centring)

This is used to centre the copied image on the paper.



This lets you place the image in the centre of the paper when the original size is smaller than the paper size or when the image is reduced.

Not using the centring function	Using the centring function
	

## 1 Place the original.

Place the original face up in the document feeder tray, or face down on the document glass.

## 2 Select the special modes.

- (1) Touch the [Special Modes] key.
  - (2) Touch the   keys to switch through the screens.
  - (3) Touch the [Image Edit] key.
-  [\[Image Edit\] KEY](#) (page 2-104)

## 3

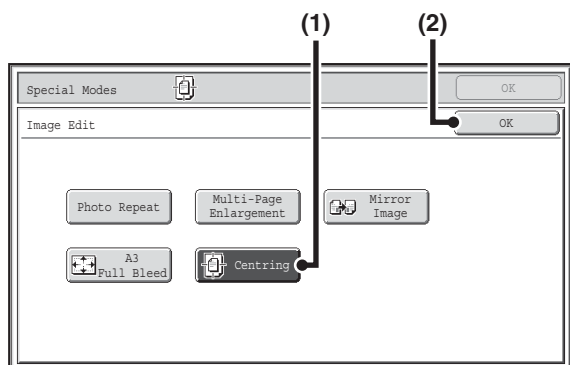

## Select Centring.



- (1) Touch the [Centring] key so that it is highlighted.
  - (2) Touch the [OK] key.
- You will return to the special modes screen. Touch the [OK] key to return to the base screen of copy mode.

## 4

## Press the [COLOUR START] key or the [BLACK & WHITE START] key.

Copying will begin.

If you are using the document glass to copy multiple original pages, copying will take place as you scan each original. If you have selected sort mode, change originals and press the [START] key. Repeat until all pages have been scanned and then touch the [Read-End] key. (For the second original and following originals, use the same [START] key as you did for the first original.

 **To cancel scanning and copying...**  
Press the [STOP] key (.



- The image can be reduced when using the centring function, but not enlarged.
- When the original size or the paper size is displayed as a special size, this function cannot be used.

**To cancel centring...**

Touch the [Centring] key in the screen of step 3 so that it is not highlighted.

# [Colour Adjustments] KEY

When the [Colour Adjustments] key is touched in the 2nd special modes menu screen, the colour adjustments menu screen opens.

## Colour adjustments menu screen

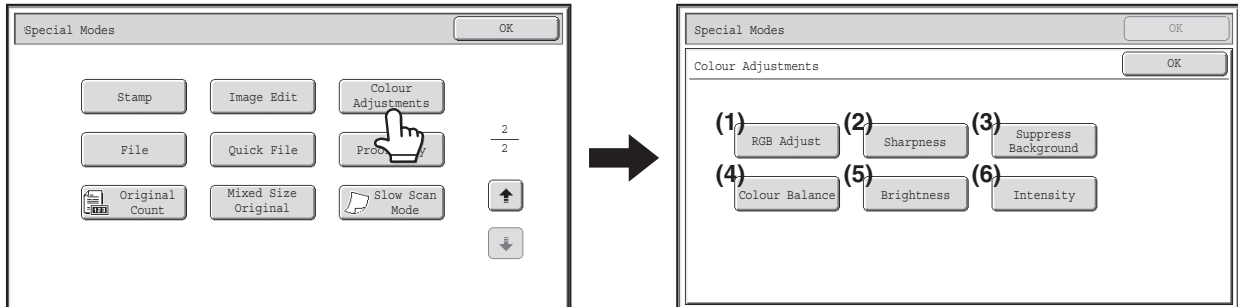

- |  |   |
|--|---|
| <p>(1) <b>[RGB Adjust] key</b><br/> <a href="#">ADJUSTING RED/GREEN/BLUE IN COPIES (RGB Adjust)</a> (page 2-116)</p> <p>(2) <b>[Sharpness] key</b><br/> <a href="#">ADJUSTING THE SHARPNESS OF AN IMAGE (Sharpness)</a> (page 2-117)</p> <p>(3) <b>[Suppress background] key</b><br/> <a href="#">WHITENING FAINT COLOURS IN COPIES (Suppress Background)</a> (page 2-118)</p> | <p>(4) <b>[Colour Balance] key</b><br/> <a href="#">ADJUSTING THE COLOUR (Colour Balance)</a> (page 2-120)</p> <p>(5) <b>[Brightness] key</b><br/> <a href="#">ADJUSTING THE BRIGHTNESS OF A COPY (Brightness)</a> (page 2-122)</p> <p>(6) <b>[Intensity] key</b><br/> <a href="#">ADJUSTING THE INTENSITY OF A COPY (Intensity)</a> (page 2-123)</p> |
|--|---|



When any of the functions on the colour adjustments menu is selected, the "Original Image Type" setting for exposure adjustment automatically changes to "Text/Prt'd.Photo".

# ADJUSTING RED/GREEN/BLUE IN COPIES (RGB Adjust)

This feature is used to strengthen or weaken any one of the three colour components R (red), G (green), or B (blue).

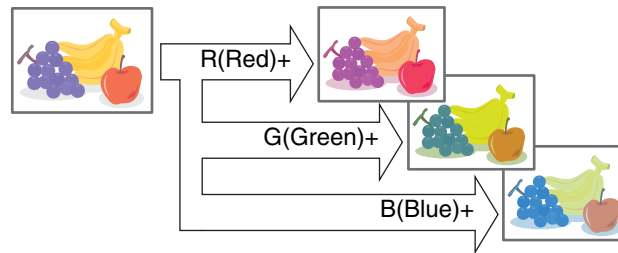

1

## Place the original.

Place the original face up in the document feeder tray, or face down on the document glass.

2

## Select the special modes.

- (1) Touch the [Special Modes] key.
- (2) Touch the keys to switch through the screens.
- (3) Touch the [Colour Adjustments] key.
- (4) Touch the [RGB Adjust] key.

[Colour Adjustments] KEY (page 2-115)

3

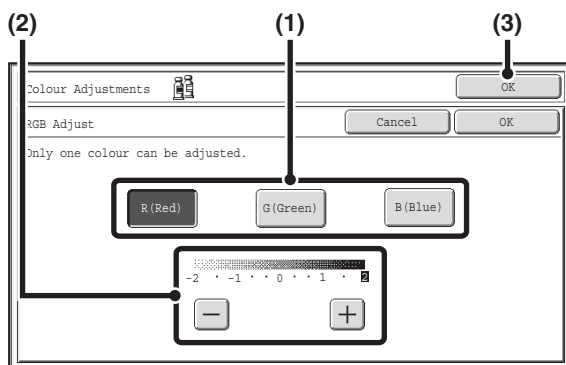

## Adjust red, green, or blue.

- (1) Touch the key of the colour that you wish to adjust: [R (Red)], [G (Green)], or [B (Blue)].  
Only one colour can be adjusted. (If you adjust one colour and then adjust another colour, the adjustment of the first colour is cancelled.)
- (2) Adjust the selected colour.  
Touch the [+] key to strengthen the selected colour, or touch the [-] key to weaken the colour.
- (3) Touch the [OK] key.  
You will return to the special modes screen. Touch the [OK] key to return to the base screen of copy mode.

4

## Press the [COLOUR START] key.

Copying will begin.

If you are using the document glass to copy multiple original pages, copying will take place as you scan each original. If you have selected sort mode, change originals and press the [COLOUR START] key. Repeat until all pages have been scanned and then touch the [Read-End] key.

To cancel scanning and copying...  
Press the [STOP] key ().



To cancel an RGB adjust setting...  
Touch the [Cancel] key in the screen of step 3.

# ADJUSTING THE SHARPNESS OF AN IMAGE (Sharpness)

This is used to sharpen an image or make it softer.

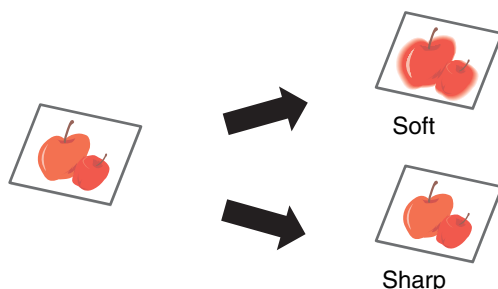

1

## Place the original.

Place the original face up in the document feeder tray, or face down on the document glass.

2

## Select the special modes.

- (1) Touch the [Special Modes] key.
- (2) Touch the keys to switch through the screens.
- (3) Touch the [Colour Adjustments] key.
- (4) Touch the [Sharpness] key.

[\[Colour Adjustments\] KEY](#) (page 2-115)

3

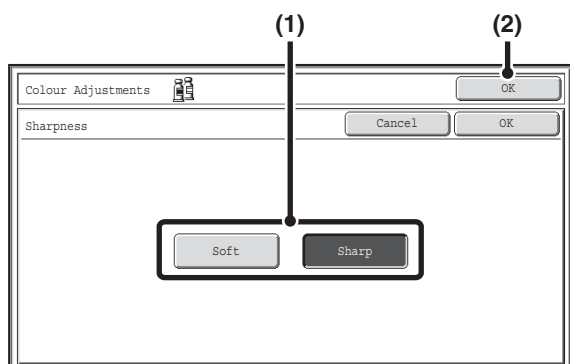

## Adjust the image.

- (1) Touch the [Soft] key or the [Sharp] key.
- (2) Touch the [OK] key.

You will return to the special modes screen. Touch the [OK] key to return to the base screen of copy mode.

4

## Press the [COLOUR START] key.

Copying will begin.

If you are using the document glass to copy multiple original pages, copying will take place as you scan each original. If you have selected sort mode, change originals and press the [COLOUR START] key. Repeat until all pages have been scanned and then touch the [Read-End] key.

**To cancel scanning and copying...**  
Press the [STOP] key ().

**To cancel the sharpness setting...**  
Touch the [Cancel] key in the screen of step 3.

# WHITENING FAINT COLOURS IN COPIES (Suppress Background)

This feature is used to suppress light background areas.

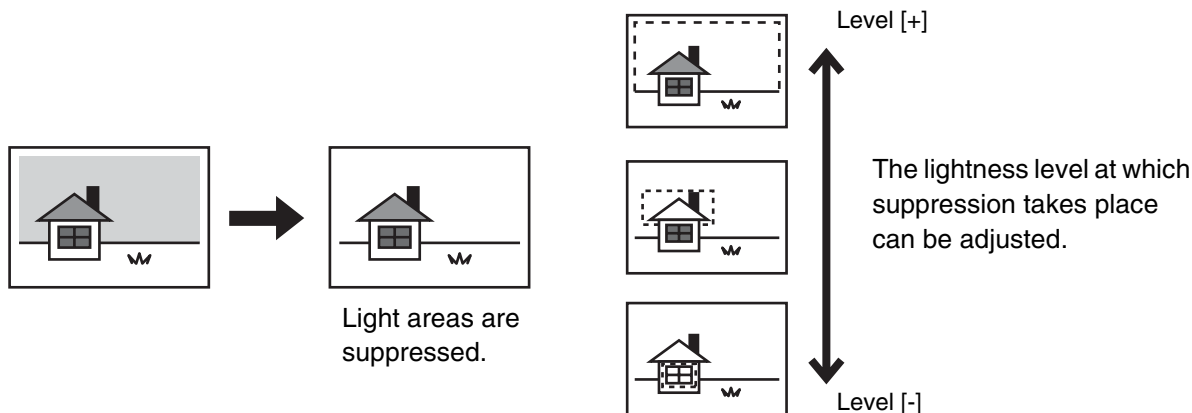

## 1 Place the original.

Place the original face up in the document feeder tray, or face down on the document glass.

## 2 Select the special modes.

- (1) Touch the [Special Modes] key.
- (2) Touch the keys to switch through the screens.
- (3) Touch the [Colour Adjustments] key.
- (4) Touch the [Suppress Background] key.

[\[Colour Adjustments\] KEY](#) (page 2-115)

## 3

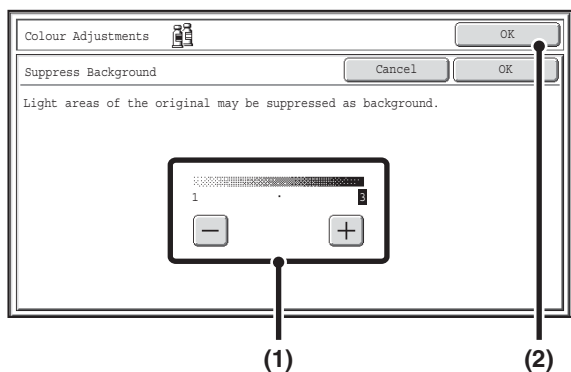

## Select the suppress background setting.

- (1) **Adjust the background suppression level.**  
 Touch the [+] key to suppress only faint background.  
 Touch the [-] key to suppress faint to dark background.
- (2) **Touch the [OK] key.**  
 You will return to the special modes screen. Touch the [OK] key to return to the base screen of copy mode.

4

**Press the [COLOUR START] key.**

Copying will begin.

If you are using the document glass to copy multiple original pages, copying will take place as you scan each original. If you have selected sort mode, change originals and press the [COLOUR START] key. Repeat until all pages have been scanned and then touch the [Read-End] key.

---

**To cancel scanning and copying...**

Press the [STOP] key (⏹).

**To cancel a suppress background setting...**

Touch the [Cancel] key in the screen of step 3.

# ADJUSTING THE COLOUR (Colour Balance)

The colour, tone, and density of colour copies can be adjusted.

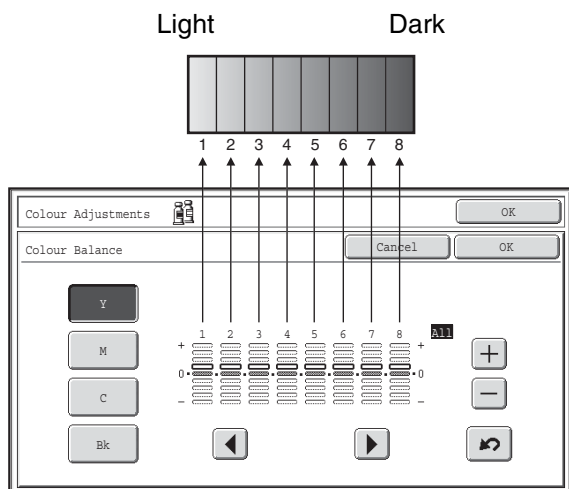

Each of the colours yellow, cyan, magenta, and black are divided into 8 gradations from light to dark, and the average density of each gradation can be adjusted, or all eight gradations can be adjusted at once.

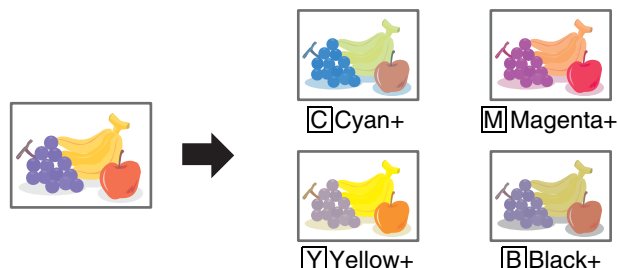



## 1

### Place the original.

Place the original face up in the document feeder tray, or face down on the document glass.

## 2

### Select the special modes.

- (1) Touch the [Special Modes] key.
- (2) Touch the   keys to switch through the screens.
- (3) Touch the [Colour Adjustments] key.
- (4) Touch the [Colour Balance] key.

 [\[Colour Adjustments\] KEY](#) (page 2-115)



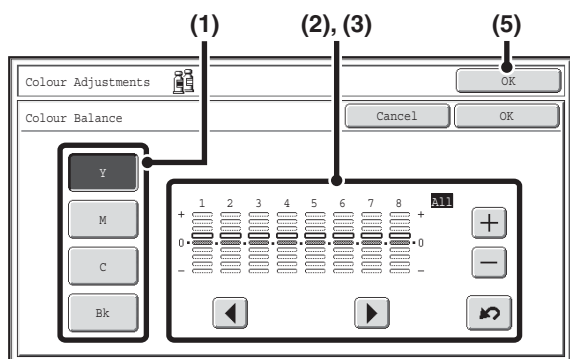

**Examples of colour balance adjustment**

3

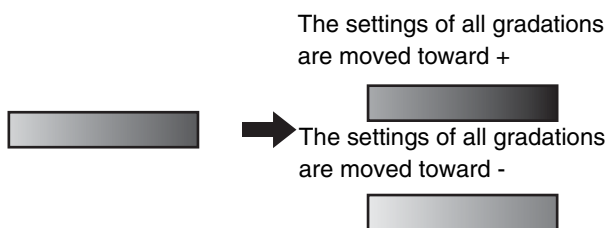

**Adjust the colour balance.**

**(1) Select the colour to be adjusted.**

Select [Y] (yellow), [M] (magenta), [C] (cyan), or [Bk] (black). If only the rectangular area around the letter in a key is highlighted, the settings have been changed from the factory default settings.

**(2) Select the gradation to be adjusted.**

Select the gradation with the [◀] [▶] keys. Touch the [◀] [▶] keys to move the highlighting to one of gradations "1" to "8" or "All". To adjust all eight gradations at once, move the highlighting to "All".

**(3) Adjust the density.**

To darken the density of the selected gradation, touch the [+] key. To lighten the density, touch the [-] key. Each time one of the keys is touched, the indicator frame moves up or down one level.

**(4) To adjust other colours, repeat steps (1) to (3).**

**(5) Touch the [OK] key.**

You will return to the special modes screen. Touch the [OK] key to return to the base screen of copy mode.

**To return the colour balance values to the default settings...**

Touch the [↶] key. The values of all eight gradations will return to the default colour balance values. The default colour balance values are set in "Initial Colour Balance Setting" in the system settings (administrator).

**Press the [COLOUR START] key.**

Copying will begin.

If you are using the document glass to copy multiple original pages, copying will take place as you scan each original. If you have selected sort mode, change originals and press the [COLOUR START] key. Repeat until all pages have been scanned and then touch the [Read-End] key.

4

**To cancel scanning and copying...**

Press the [STOP] key (⏹).

**To cancel a colour balance setting...**

Touch the [Cancel] key in the screen of step 3.

**System Settings (Administrator): Initial Colour Balance Setting**

This is used to set the default values to which the colour balance values return when the [↶] key is pressed.

# ADJUSTING THE BRIGHTNESS OF A COPY (Brightness)

The brightness of colour images can be adjusted.

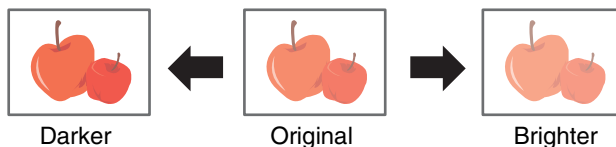

1

## Place the original.

Place the original face up in the document feeder tray, or face down on the document glass.

2

## Select the special modes.

- (1) Touch the [Special Modes] key.
- (2) Touch the keys to switch through the screens.
- (3) Touch the [Colour Adjustments] key.
- (4) Touch the [Brightness] key.

[\[Colour Adjustments\] KEY](#) (page 2-115)

3

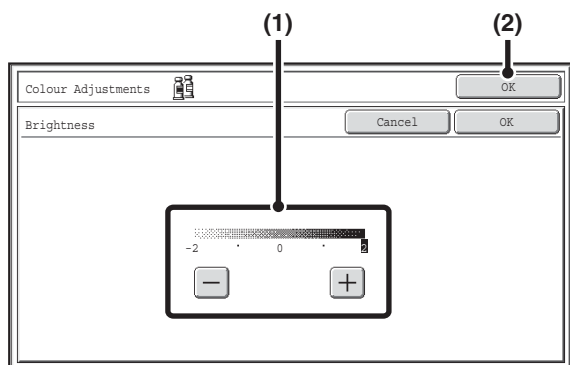

## Adjust the brightness.

### (1) Adjust the brightness.

Touch the [+] key to make the image brighter, or the [-] key to make the image darker.

### (2) Touch the [OK] key.

You will return to the special modes screen. Touch the [OK] key to return to the base screen of copy mode.

4

## Press the [COLOUR START] key.

Copying will begin.

If you are using the document glass to copy multiple original pages, copying will take place as you scan each original. If you have selected sort mode, change originals and press the [COLOUR START] key. Repeat until all pages have been scanned and then touch the [Read-End] key.

**To cancel scanning and copying...**  
Press the [STOP] key ().

### To cancel a brightness setting...

Touch the [Cancel] key in the screen of step 3.

# ADJUSTING THE INTENSITY OF A COPY (Intensity)

This is used to adjust the intensity (saturation) of colour images.

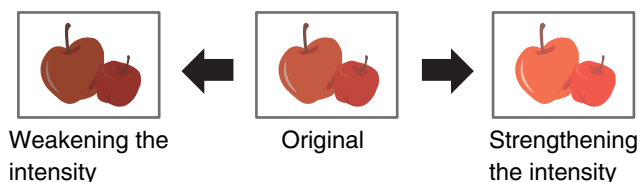

1

## Place the original.

Place the original face up in the document feeder tray, or face down on the document glass.

2

## Select the special modes.

- (1) Touch the [Special Modes] key.
- (2) Touch the keys to switch through the screens.
- (3) Touch the [Colour Adjustments] key.
- (4) Touch the [Intensity] key.

[\[Colour Adjustments\] KEY](#) (page 2-115)

3

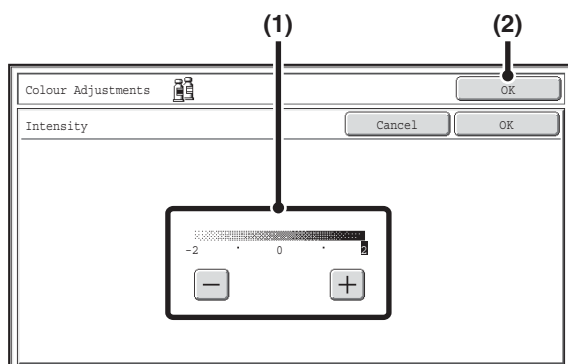

## Adjust the intensity.

### (1) Adjust the intensity setting.

Touch the [+] key to strengthen the intensity, or the [-] key to weaken the intensity.

### (2) Touch the [OK] key.

You will return to the special modes screen. Touch the [OK] key to return to the base screen of copy mode.

4

## Press the [COLOUR START] key.

Copying will begin.

If you are using the document glass to copy multiple original pages, copying will take place as you scan each original. If you have selected sort mode, change originals and press the [COLOUR START] key. Repeat until all pages have been scanned and then touch the [Read-End] key.



### To cancel scanning and copying...

Press the [STOP] key ().



This function cannot be used in combination with "Colour Tone Enhancement" in the copy exposure settings.



### To cancel an intensity setting...

Touch the [Cancel] key in the screen of step 3.

# CHECKING COPIES BEFORE PRINTING (Proof Copy)

(On the MX-2314N, the productivity kit is required.)

This feature prints only one set of copies, regardless of how many sets have been specified. After the first set is checked for errors, the remaining sets can be printed. Previously it was necessary to re-scan the original each time changes to settings were required. However, this feature makes it possible to change settings for the scanned original without scanning it again, allowing you to perform copying more efficiently.

"Proof Copy" is selected and 5 sets of copies are executed



1 set of copies is printed for you to check



If OK



The remaining 4 sets are printed

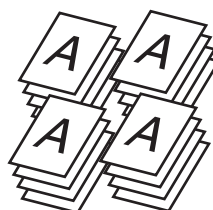

Adjust the settings



If OK

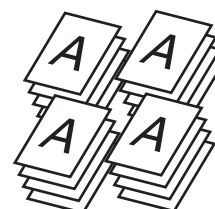

After adjustments are made, 1 set is printed for you to check

The remaining 4 sets are printed

## 1

### Place the original.

Place the original face up in the document feeder tray, or face down on the document glass.

## 2

### Select copy settings in the base screen.

## 3

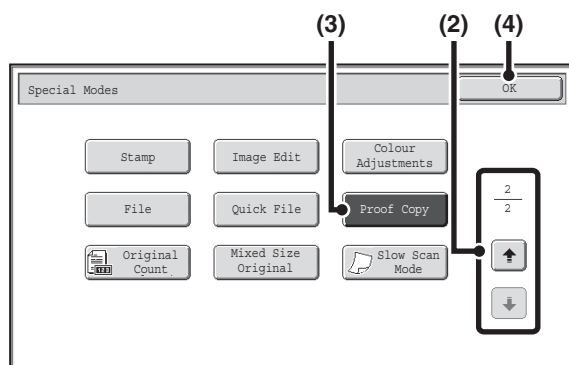

### Select Proof Copy.

- (1) Touch the [Special Modes] key.  
[SPECIAL MODES](#) (page 2-41)
- (2) Touch the keys to switch through the screens.
- (3) Touch the [Proof Copy] key so that it is highlighted.
- (4) Touch the [OK] key.

4

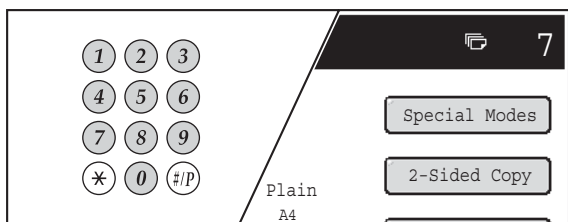

**Set the number of copies (number of sets) with the numeric keys.**

If you will copy multiple originals using the document glass, switch to sort mode after this step.

☛ [Sort mode](#) (page 2-35)

Up to 999 copies (sets) can be set.

**If an incorrect number of copies is set...**  
Press the [CLEAR] key (Ⓢ) and then enter the correct number.

5

**Press the [COLOUR START] key or the [BLACK & WHITE START] key.**

One set of copies is printed.

If you are using the document glass to copy multiple originals, change originals and press the [START] key. Repeat until all pages have been scanned and then touch the [Read-End] key. One set of copies will be printed. (For the second original and following originals, use the same [START] key as you did for the first original.

**To cancel copying...**  
Press the [STOP] key (Ⓢ).

6

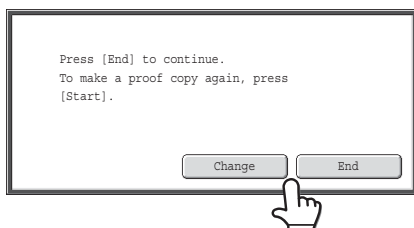

**Check the printed set of copies. If the copies are acceptable, touch the [End] key. If you need to change the settings, touch the [Change] key.**

When the [End] key is touched, the remaining sets are printed. If you touched the [Change] key, go to the next step.

**To cancel copying...**  
Press the [STOP] key (Ⓢ).

7

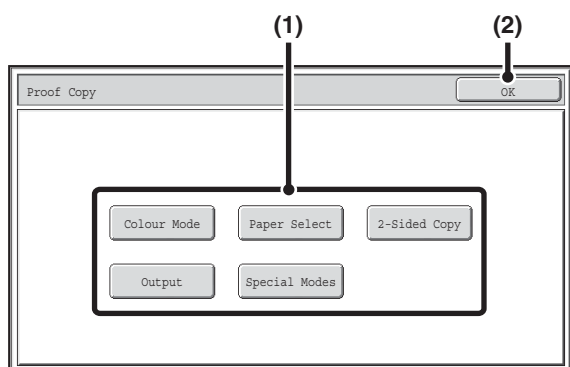

### Change the settings.

(1) Touch the key of the setting that you want to change.

The setting screen of the touched key opens. Change the settings and touch the [OK] key.

(2) Touch the [OK] key.



- To change the number of sets printed, set the desired number of copies (sets) with the numeric keys. After changing the number of sets, touch the [End] key in the touch panel (not the [START] key) to print the sets.
- Special modes that can be adjusted are Margin Shift, Pamphlet Copy, Tandem Copy, Covers/Inserts, Transparency Inserts, Multi-Shot, and Stamp.
- For Pamphlet Copy, Covers/Inserts, and Multi Shot, only changes to the settings of the functions can be made; the functions cannot be newly added or deleted.
- When transparency film is used, the settings can be changed, new settings can be added, and the function can be cancelled. However, this is not possible when pamphlet copying is enabled.

8

### Press the [COLOUR START] key or the [BLACK & WHITE START] key.

One set of copies is printed again using the adjusted settings. Check the results. If further adjustments are needed, repeat steps 6 through 8. (Repeating Proof Copy does not decrease the remaining number of sets to be printed.)

9

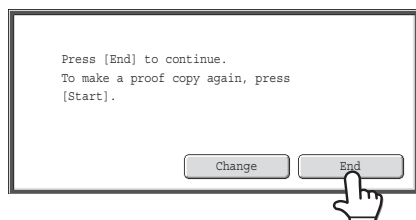

### Touch the [End] key.

You will return to the base screen of copy mode and the remaining sets will be printed.



#### To cancel scanning and copying...

Press the [STOP] key (⏹).



If Proof Copy is executed while the machine is printing another job, the other job is interrupted and the proof copies are printed. The previous job will resume after the proof copies are printed. However, if proof copy is executed during output of a job for which both two-sided printing and stapling are enabled, the proof copy will be output after the job in progress is finished. If the [End] key is touched to execute printing of the remaining sets while the machine is printing another job, the remaining sets will be printed after all previously reserved jobs are completed.

# CHECKING THE NUMBER OF SCANNED ORIGINAL SHEETS BEFORE COPYING (Original Count)

The number of scanned original sheets can be counted and displayed before copying is executed. By allowing you to check the number of original sheets that were scanned, this helps reduce the occurrence of copy mistakes.

1

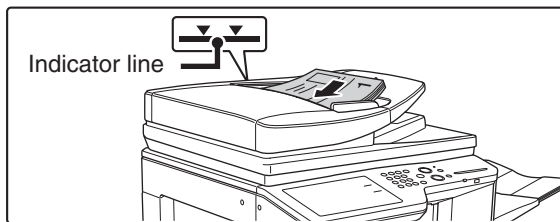



## Insert the originals face up in the document feeder tray.

Insert the originals all the way into the document feeder tray. Multiple originals can be placed in the document feeder tray. The stack of originals must not be higher than the indicator line on the tray.

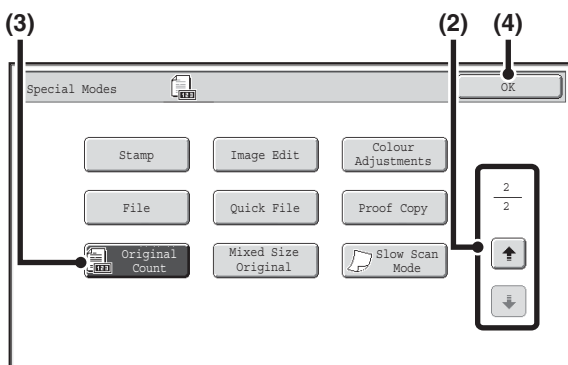
2



## Select Original Count.

- (1) Touch the [Special Modes] key.  
 [SPECIAL MODES](#) (page 2-41)
- (2) Touch the   keys to switch through the screens.
- (3) Touch the [Original Count] key so that it is highlighted.
- (4) Touch the [OK] key.

You will return to the base screen of copy mode.

3

## Press the [COLOUR START] key or the [BLACK & WHITE START] key.



To cancel scanning and copying...  
Press the [STOP] key (.

4

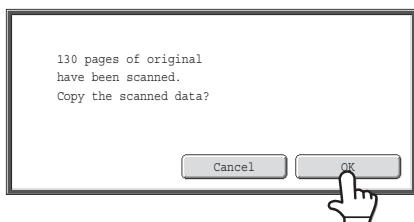

**After scanning is finished, check the number of sheets that were scanned and touch the [OK] key.**

Copying will begin.

- When job build mode is used, the number of scanned sheets appears when the [Read-End] key is touched.
- The number that is displayed is the number of scanned original sheets, not the number of scanned original pages. For example, when two-sided copying is performed using one original, the number "1" will appear to indicate that one original sheet was scanned, not "2" to indicate the front-side page and the reverse side page.



**If the displayed number of original sheets is different from the actual number of original sheets...**  
Press the [STOP] key (⏏).



**To cancel the original count mode setting...**

Touch the [Original Count] key in the screen of step 2 so that it is not highlighted.



# COPYING ORIGINALS OF DIFFERENT SIZES (Mixed Size Original)

Even when B4 (8-1/2" x 14") originals are mixed in with A3 (11" x 17") originals, all originals can be copied at once. When scanning the originals, the machine automatically detects the size of each original and uses paper appropriate for that size. When mixed size original is combined with auto ratio selection, the ratio is adjusted individually for each original according to the selected paper size, enabling output on a uniform paper size.

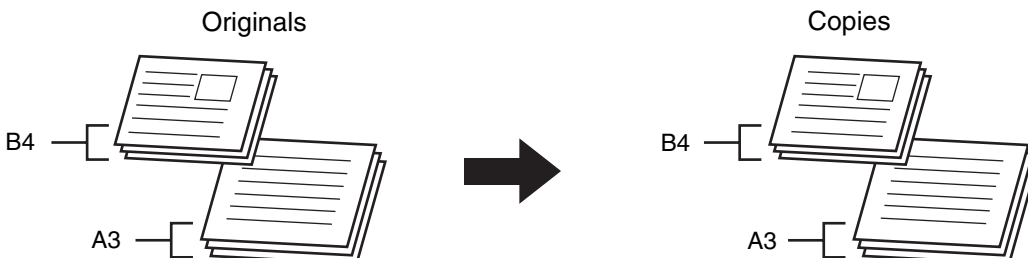

**When mixed size original is combined with auto ratio selection**  
(Auto ratio selection and A3 (11" x 17") are selected)

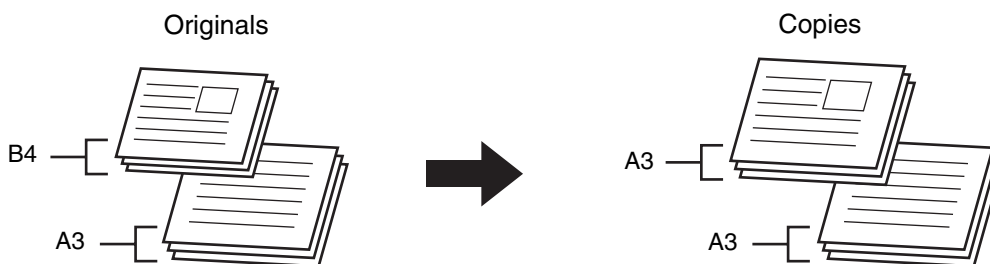

A B4 (8-1/2" x 14") size original will be enlarged to A3 (11" x 17") size.

There are two settings for mixed size originals.

<b>Same Width</b>	<p>Use this setting for originals that are different sizes but have sides that are the same length. The originals are inserted in the document feeder tray with the sides that are the same length aligned together on the left.</p> <ul style="list-style-type: none"> <li>• A3 and A4    • B4 and B5    • A4R and A5</li> <li>• 11" x 17" and 8-1/2" x 11"    • 8-1/2" x 14" and 8-1/2" x 11"R    • 8-1/2" x 14" and 5-1/2" x 8-1/2"</li> <li>• 8-1/2" x 13" and 8-1/2" x 11"R    • 8-1/2" x 13" and 5-1/2" x 8-1/2"    • 8-1/2" x 11"R and 5-1/2" x 8-1/2"</li> </ul>
<b>Different Width</b>	<p>Use this setting when the originals are different sizes and do not have sides that are the same length. This setting can only be used for the following combinations of sizes:</p> <ul style="list-style-type: none"> <li>• A3 and B4    • A3 and B5    • B4 and A4    • A4 and B5    • B4 and A4R    • B4 and A5</li> <li>• B5 and A4R    • B5 and A5</li> <li>• 11" x 17" and 8-1/2" x 14"    • 11" x 17" and 8-1/2" x 13"    • 11" x 17" and 5-1/2" x 8-1/2"</li> </ul>

1

**Insert the originals face up in the document feeder tray.**

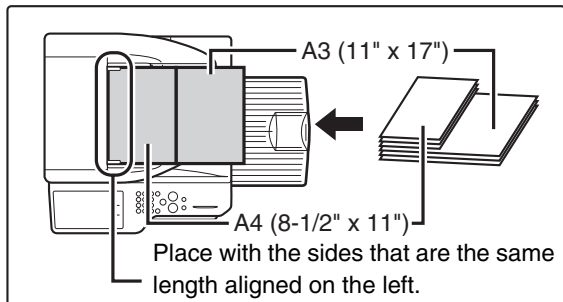

● **When "Same Width" is used**

Place the originals with the sides that are the same length aligned on the left.

● **When "Different Width" is used**

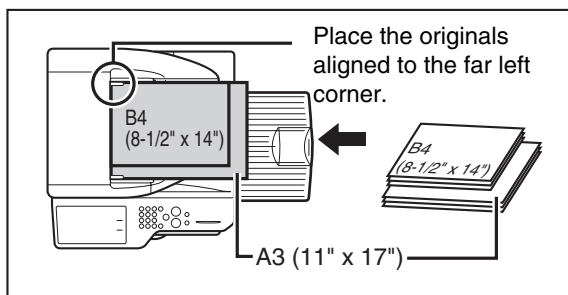

Place the originals with the corners aligned in the far left corner of the document feeder tray.

2

**Select the special modes.**

- (1) Touch the [Special Modes] key.
- (2) Touch the keys to switch through the screens.
- (3) Touch the [Mixed Size Original] key.

[Special modes menu \(2nd screen\)](#) (page 2-42)

3

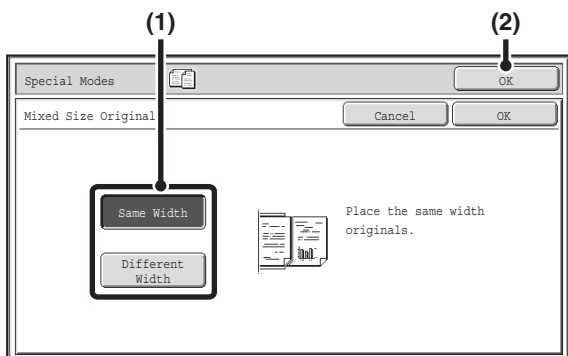

**Select Mixed Size Original settings.**

- (1) Touch the [Same Width] key or the [Different Width] key as appropriate for the originals.
- (2) Touch the [OK] key.  
You will return to the base screen of copy mode.

4

Press the [COLOUR START] key or the [BLACK & WHITE START] key.

Copying will begin.



**To cancel scanning and copying...**

Press the [STOP] key (⏹).



- When [Different Width] is selected, automatic two-sided copying cannot be used.
- When [Different Width] is selected, the staple function cannot be used.
- The mixed size original function cannot be used to copy originals that are the same size but are placed in different orientations (A4 and A4R (8-1/2" x 11" and 8-1/2" x 11"R), etc.).



**To cancel the mixed size original setting...**

Touch the [Cancel] key in the screen of step 3.



**System Settings (Administrator): Original Feeding Mode**

The original feeding mode can be set to always scan mixed size originals.

# COPYING THIN ORIGINALS (Slow Scan Mode)

Use this function when you wish to scan thin originals using the automatic document feeder. This function helps prevent thin originals from misfeeding.

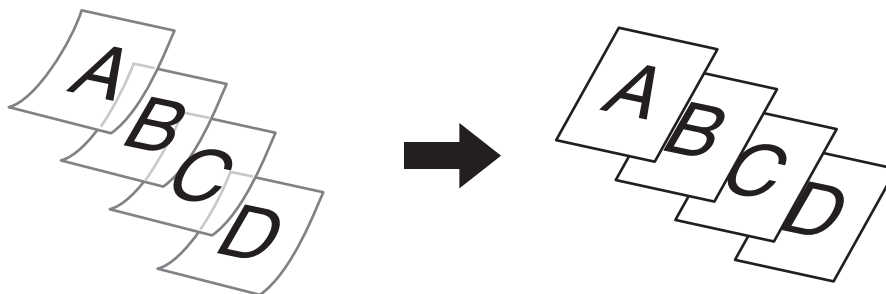

1

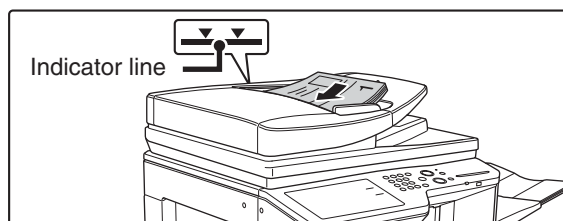

## Insert the originals face up in the document feeder tray.

Insert the originals all the way into the document feeder tray. Multiple originals can be placed in the document feeder tray. The stack of originals must not be higher than the indicator line on the tray.



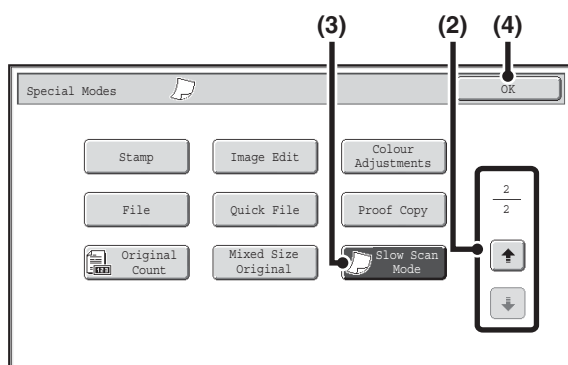

If the originals are inserted with too much force, they may crumple and misfeed.

2



## Select Slow Scan Mode.

- (1) Touch the [Special Modes] key.  
 **SPECIAL MODES** (page 2-41)
- (2) Touch the   keys to switch through the screens.
- (3) Touch the [Slow Scan Mode] key so that it is highlighted.
- (4) Touch the [OK] key.

You will return to the base screen of copy mode.

3

## Press the [COLOUR START] key or the [BLACK & WHITE START] key.

Copying will begin.



**To cancel scanning and copying...**  
 Press the [STOP] key (.



The "2-Sided to 2-Sided" and "2-Sided to 1-Sided" modes of automatic 2-sided copying cannot be used.



**To cancel the slow scan mode setting...**

Touch the [Slow Scan Mode] key in the screen of step 2 so that it is not highlighted.



**System Settings (Administrator): Original Feeding Mode**

This is used to have scanning always take place in slow scan mode.

# CONVENIENT COPY FUNCTIONS

This section explains convenient copy functions such as interrupting a copy run, changing the order of reserved copy jobs, and storing copy settings in a program.

## INTERRUPTING A COPY RUN (Interrupt copy)

When you need to make an urgent copy and the machine is busy with a long copy run or other job, use interrupt copy. Interrupt copy temporarily stops the job in progress and lets you perform the interrupt copy job first.

1

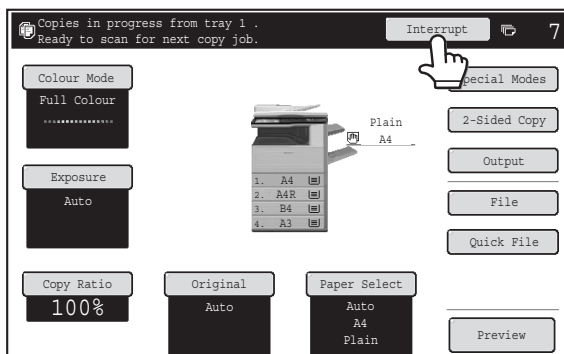

### Touch the [Interrupt] key.

The [Interrupt] key does not appear while an original is being scanned.

2

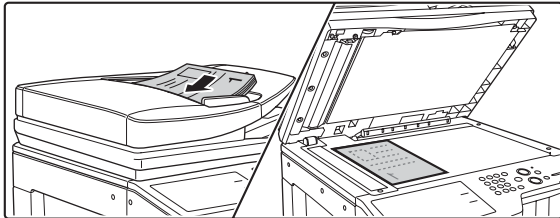

### Place the original.

Place the original face up in the document feeder tray, or face down on the document glass.

3

### Select copy settings and press the [COLOUR START] key or the [BLACK & WHITE START] key.

The interrupt copy job begins.

4

### When the interrupt copy job is completed, the interrupted job resumes.



To cancel scanning and copying...  
Press the [STOP] key (⏹).



- If user authentication is enabled, the login screen will appear when the [Interrupt] key is pressed. Enter your user name and password to log in. The number of copies made will be added to the count of the user that logged in.
- Depending on the settings of the job in progress, the [Interrupt] key may not appear.
- Depending on the settings of the job in progress, the [Reserve] key may appear instead of the [Interrupt] key. Unlike interrupt copy, reserve copy does not temporarily stop the job in progress. Instead, the reserve copy job begins when the job in progress is finished.
- Interrupt copy cannot be used in combination with the following special modes:  
Job Build, Tandem Copy, Book Copy, Card Shot, Multi-Page Enlargement, Original Count
- If the document glass is used for an interrupt copy job, 2-sided copying, sort copying, and staple sort copying cannot be selected. If any of these functions are necessary, use the automatic document feeder.

# CHECKING A PREVIEW IMAGE OF A COPY (Preview)

(On the MX-2314N, the productivity kit is required.)

You can touch the [Preview] key so that it is highlighted in the base screen and then scan the original to check a preview image of the copy in the touch panel before printing the copy.

## 1 Place the original.

Place the original face up in the document feeder tray, or face down on the document glass.

## 2

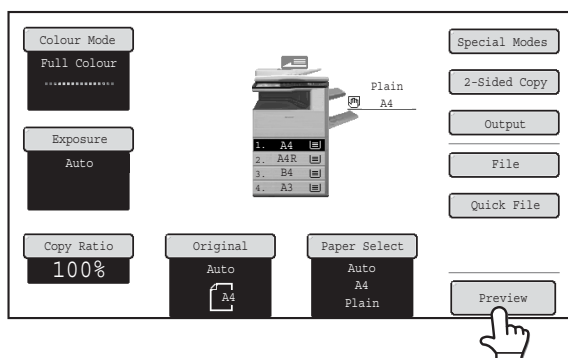

Touch the [Preview] key so that it is highlighted.

## 3

Select copy settings and press the [COLOUR START] key or the [BLACK & WHITE START] key.

After the original is scanned, a preview image of the copy appears in the touch panel. The copy is not printed until the [Start Copy] key is touched in the preview screen.

## 4

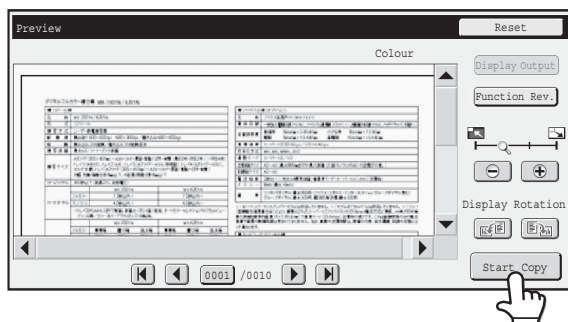



Check the preview image and then touch the [Start Copy] key.

Copy printing begins.

For details on the preview screen, see "[PREVIEW SCREEN](#)" (page 2-138).

 If you need to change the copy settings, touch the [Reset] key.

 **To cancel copying...**  
Press the [STOP] key (.



**To cancel the operation...**

Press the [CLEAR ALL] key (CA).

**System Settings (Administrator): Default Preview**

You can set the default state of the [Preview] key to always selected (highlighted). Enable this setting if you wish to check a preview image each time you make a copy.

# PREVIEW SCREEN

The preview screen is explained below.

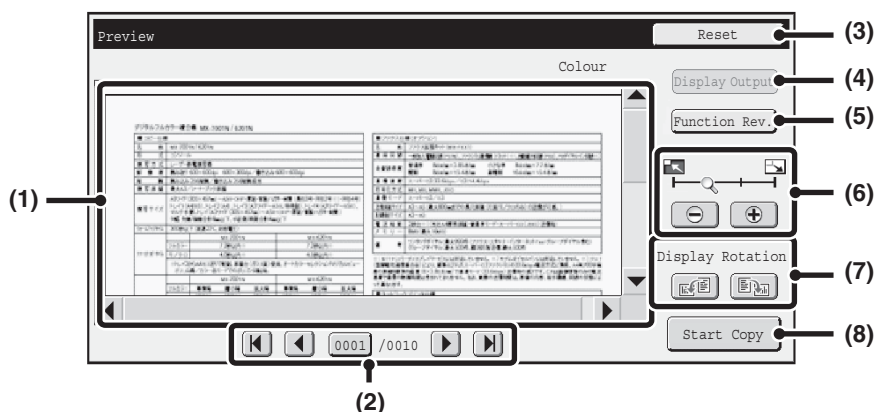

**(1) Preview image**

An image of the selected received image appears. If the image is cut off, use the scroll bars at the right and bottom of the screen to scroll the image. Touch a bar and slide it to scroll. (You can also touch the keys to scroll.)

**(2) Change page keys**

When there are multiple pages of images, use these keys to change pages.

- keys: Go to the first or the last page.
- keys: Go to the previous page or the next page.
- Page number display: This shows the total number of pages and the current page number. You can touch the current page number key and enter a number with the numeric keys to go to that page number.

**(3) [Reset] key**

Touch to change the copy settings after checking the preview image. After changing the settings, touch the [Preview Again] key to update the preview image with the new settings.

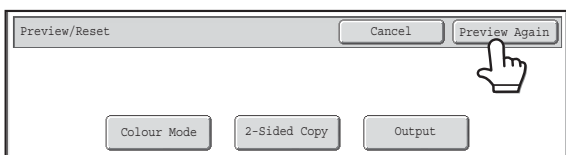

**(4) [Display Output] key**

Touch to show the selected modes and settings as icons. Functions that are displayed are as follows:

- 2-sided copying
- Pamphlet copy
- Book copy
- Staple function
- Punch function
- Stamp menu
- Covers/Inserts
- Transparency inserts

This key can only be touched when the entire preview image is displayed in the preview screen.

**(5) [Function Rev.] key**

Touch to check special mode items, 2-sided copying, and output settings.

**(6) Display zoom key**

Use this to set the zoom ratio of the displayed image. Changes from the left in the order "Full Page", "Twice", "4 Times", "8 Times". The setting applies to all pages in the file, not just the displayed page.

**(7) "Display Rotation" key**

This rotates the image right or left by 90 degrees. The rotation applies to all pages in the file, not just the displayed page.

**(8) [Start Copy] key**

Touch to start printing the copy.



- A preview image is an image for display on the touch panel. It will differ from the actual print result.
- The preview image reflects certain copy settings and special mode settings. Settings that are reflected in the preview image are as follows:  
 Copy settings: colour mode, ratio, paper size  
 Special modes: margin shift, edge erase, dual page copy, pamphlet copy, covers/inserts, transparency film, 2 in 1/4 in 1, book copy, card shot, image edit menu, colour adjustment (excluding sharpness and colour balance)
- Fine lines (such as borderlines printed by the 2in1/4in1 function) may not appear correctly at some zoom ratios.

# JOB STATUS SCREEN

The job status screen is displayed when the [JOB STATUS] key (Ⓜ) on the touch panel is touched. The job status screen shows the status of jobs by mode. When the [JOB STATUS] key (Ⓜ) is touched, the job status screen of the mode that was being used before the key was pressed appears.

## Example: Pressing the key in copy mode

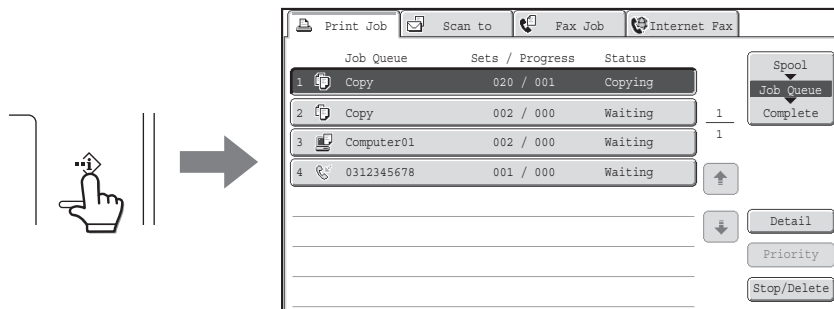

On the MX-2314N, the productivity kit is required. [Spool] is not displayed.

 The job status display (A) is in the lower left corner of the touch panel. The job status display can be touched to display the job status screen. The first four jobs in the print queue (the job in progress and reserved jobs) can be checked in the job status display (B).

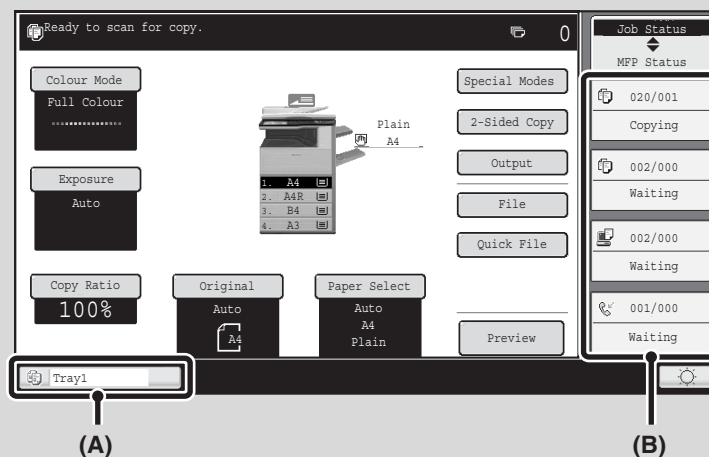

# JOB QUEUE SCREEN AND COMPLETED JOB SCREEN

The job status screen consists of the job queue screen that shows copy and print jobs waiting to be printed and the job currently in progress, the completed job screen that shows jobs that have been completed, and the spool screen that shows print jobs that have been spooled and encrypted PDF jobs that are waiting for a password to be entered. This section explains the job queue screen and the completed jobs screen, which are related to copy mode. The job status screen switches between the job queue screen and the completed jobs screen each time the job status screen selector key is touched.

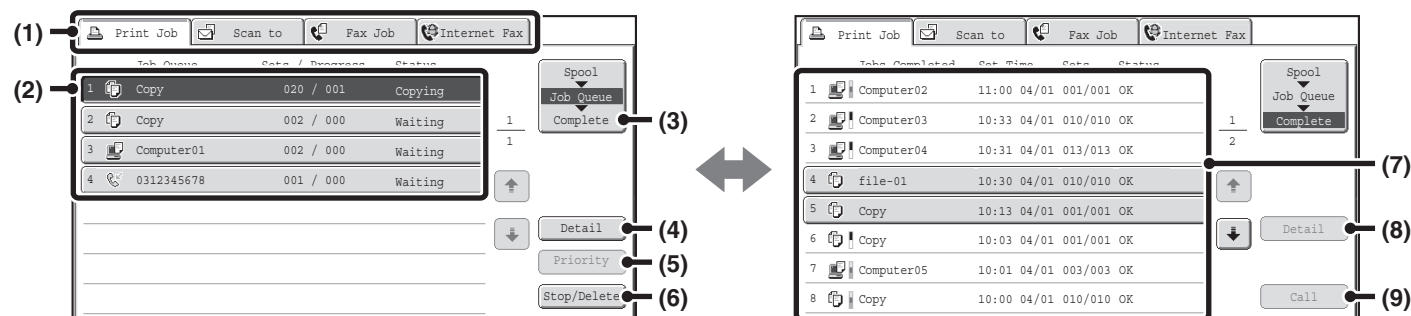

## (1) Mode select tabs

Use these tabs to select the mode that is shown in the job status screen.  
The status of copy jobs can be checked by touching the [Print Job] tab.

## (2) Job list (job queue screen)

Jobs waiting to be printed appear in the job queue as keys. The jobs are printed in order from the top of the queue. Each job key shows information on the job and the current status of the job.

## (3) Job status screen selector key\*

Touch this key to switch through the job queue screen, the completed jobs screen, and the spool screen.  
\* On the MX-2314N, the productivity kit is required.

## (4) [Detail] key (job queue screen)

Touch this key to display detailed information on a job.

## (5) [Priority] key

Touch this key to give priority to a selected job.

## (6) [Stop/Delete] key

Touch this key to stop or delete a selected job.

## (7) Job list (completed jobs screen)

This shows up to 99 completed jobs. The result (status) of each completed job is shown. Copy jobs that used the document filing function are indicated as keys.

## (8) [Detail] key (completed jobs screen)

When a job is shown as a key in the job list, the [Detail] key can be touched to show detailed information on the job.

## (9) [Call] key\*

Touch this key to retrieve and use a copy job stored using the document filing function.

\* On the MX-2314N, the productivity kit is required.

## Job key display

Each job key shows the position of the job in the job queue and the current status of the job.

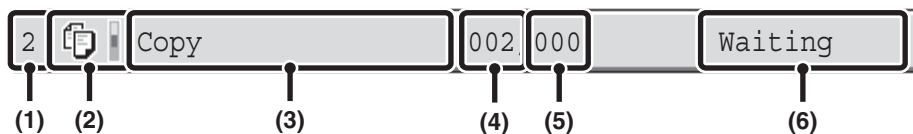

**(1) Indicates the number (position) of the job in the job queue.**

When the job currently being printed is finished, the job moves up one position in the job queue. This number does not appear in keys in the completed jobs screen.

**(2) Mode icon**

The  icon appears when the job is a copy job. In the completed jobs screen, a colour bar appears next to the icon to indicate whether the job was executed in colour or black & white. (However, the colour bar icon does not appear in the key of a job that used document filing or in the key of a transmission/reception job that was cancelled.)

**(3) Job name**

"Copy" appears for a copy job. When user authentication is enabled, the name of the user that performed the job appears.

**(4) Number of copies (sets) entered**

This shows the number of copies (sets) specified.

**(5) Number of completed copies**

This shows the number of copies (sets) completed. "000" appears while the job is waiting in the job queue.

**(6) Status**

Shows the job status.

Message	Status
"Copying"	Copying is in progress.
"Waiting"	The job is waiting to be executed.
"Toner Empty"	The toner cartridge is out of toner. Replace the toner cartridge with a new cartridge.
"Paper Empty"	The paper used for the job has run out. Add paper or change to a different paper tray.
"Limit"	The copy page limit has been exceeded. Check with the administrator of the machine.
"Error"	An error occurred while the job was being executed. Clear the error condition.

# CANCELLING A JOB THAT IS WAITING IN THE QUEUE

A copy job that is waiting to be printed can be cancelled.

1

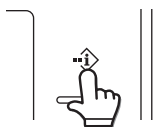

Touch the [JOB STATUS] key (⏏).

2

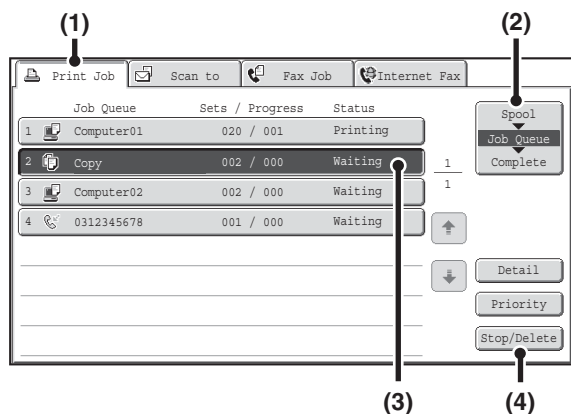

## Cancel the job.

- (1) Touch the [Print Job] tab.
- (2) Change the print job status mode to [Job Queue].  
Touch this key to change modes. The selected mode will be highlighted.
- (3) Touch the key of the copy job that you wish to cancel.
- (4) Touch the [Stop/Delete] key.
- (5) A message appears to confirm the cancellation. Touch the [Yes] key.

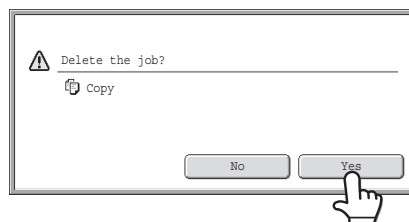

The selected job key is deleted and printing is cancelled.



If the job in progress is a copy job, you can also press the [STOP] key (⏏) to display the above screen. To cancel, touch the [Yes] key.



If you do not want to cancel the selected print job... Touch the [No] key in step (5).

# GIVING PRIORITY TO A JOB IN THE QUEUE

If a copy job is begun when there are already multiple jobs in the queue, the copy job will appear at the end of the queue. However, if you have an urgent copy job, you can give priority to the job and have it executed first.

1

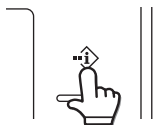

Touch the [JOB STATUS] key (⬠➡).

2

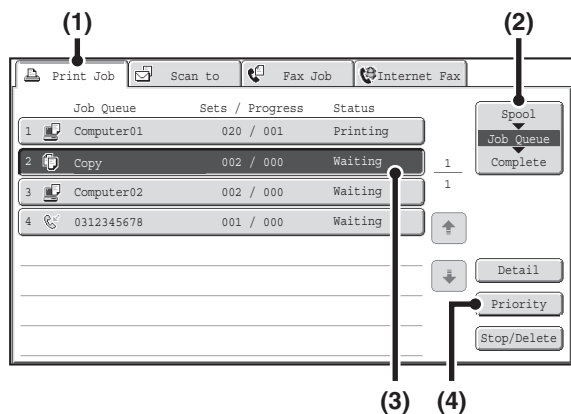

**Give the desired job priority.**

(1) Touch the [Print Job] tab.

(2) Change the print job status mode to [Job Queue].

Touch this key to change modes. The selected mode will be highlighted.

(3) Touch the key of the copy job to which you want to give priority.

(4) Touch the [Priority] key.

The job being printed stops and the job selected in (3) is printed.

# CHECKING INFORMATION ON A COPY JOB WAITING IN THE QUEUE

Detailed information can be displayed on a copy job waiting in the queue.

1



**Touch the [JOB STATUS] key (  ).**

2

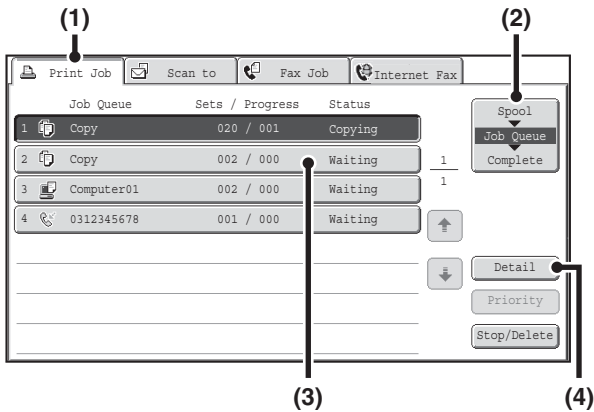

**Checking job details**



**(1) Touch the [Print Job] tab.**

**(2) Change the print job status mode to [Job Queue].**  
 Touch this key to change modes. The selected mode will be highlighted.

**(3) Touch the key of the job that you wish to check.**

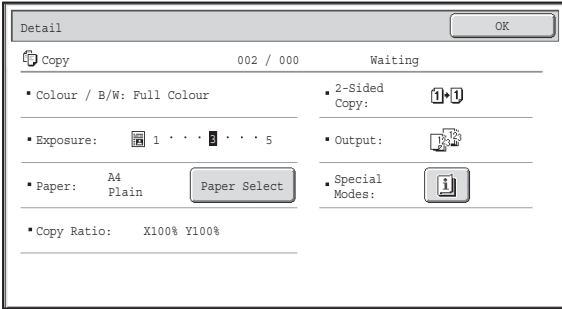
**(4) Touch the [Detail] key.**  
 The job check screen of the job selected in (3) appears.



 **[Paper Select] key**  
 If a copy job is stopped because the paper ran out, the [Paper Select] key can be pressed to change to a different paper tray.  
 When the [Paper Select] key is pressed, the paper tray selection screen appears.  
 **PAPER TRAYS** (page 2-11)  
 Touch the key of the tray that has the size of paper that you wish to use and then touch the [OK] key. The stopped copy job will resume.



# STORING COPY OPERATIONS (Job Programs)

A job program is a group of copy settings stored together. When copy settings are stored in a job program, the settings can be retrieved and used for a copy job by means of a simple operation.

For example, suppose A3 (11" x 17") size CAD drawings are copied once a month for archive purposes using the following settings:

A3 (11" x 17") size CAD drawings

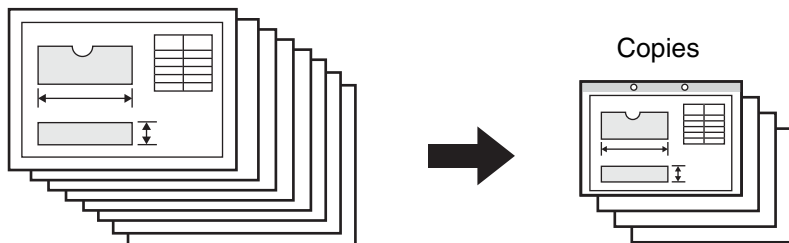

- (1) The A3 (11" x 17") size CAD drawings are reduced to A4 (8-1/2" x 11") size.
- (2) The drawings have fine lines that do not show clearly, and thus a dark exposure setting (level 4) is used.
- (3) To reduce paper use by half, 2-sided copying is used.
- (4) Margin shift is used so that holes can be punched for filing.

When a job program is not stored	When a job program is stored																
<p>Set A3 (11" x 17") to A4 (8-1/2" x 11") reduction</p> <p style="text-align: center;">↓</p> <p>Change the exposure setting</p> <p style="text-align: center;">↓</p> <p>Select 2-sided copying</p> <p style="text-align: center;">↓</p> <p>Select margin shift</p> <p style="text-align: center;">↓</p> <p>Select punch hole settings</p> <p style="text-align: center;">↓</p> <p>Press the [COLOUR START] key or the [BLACK &amp; WHITE START] key.</p>	<p style="text-align: center;">#/P</p> <p style="text-align: center;">Press the [# / P] key ( <math>\frac{\#}{P}</math> ).</p> <p style="text-align: center;">↓</p> <div style="border: 1px solid black; padding: 5px; width: fit-content; margin: 0 auto;"> <p>Job Programs <span style="float: right;">Exit</span></p> <p>Press program number.</p> <table style="width: 100%; border-collapse: collapse;"> <tr> <td style="border: 1px solid gray; padding: 2px 10px;">1</td> <td style="border: 1px solid gray; padding: 2px 10px;">2</td> <td style="border: 1px solid gray; padding: 2px 10px;">3</td> <td style="border: 1px solid gray; padding: 2px 10px;">1 4</td> </tr> <tr> <td style="border: 1px solid gray; padding: 2px 10px;">4</td> <td style="border: 1px solid gray; padding: 2px 10px;">5</td> <td style="border: 1px solid gray; padding: 2px 10px;">6</td> <td style="border: 1px solid gray; padding: 2px 10px;">↑</td> </tr> <tr> <td style="border: 1px solid gray; padding: 2px 10px;">7</td> <td style="border: 1px solid gray; padding: 2px 10px;">8</td> <td style="border: 1px solid gray; padding: 2px 10px;">9</td> <td style="border: 1px solid gray; padding: 2px 10px;">↓</td> </tr> <tr> <td style="border: 1px solid gray; padding: 2px 10px;">10</td> <td style="border: 1px solid gray; padding: 2px 10px;">11</td> <td style="border: 1px solid gray; padding: 2px 10px;">12</td> <td></td> </tr> </table> <p style="text-align: center; margin-top: 5px;">Recall <span style="float: right;">Store/Delete</span></p> </div> <p style="text-align: center;">Touch the stored program key.</p> <p style="text-align: center;">↓</p> <p>Press the [COLOUR START] key or the [BLACK &amp; WHITE START] key.</p>	1	2	3	1 4	4	5	6	↑	7	8	9	↓	10	11	12	
1	2	3	1 4														
4	5	6	↑														
7	8	9	↓														
10	11	12															
<p>Considerable time is required to copy the drawings each month because the above settings must be selected. In addition, mistakes are occasionally made when selecting the settings, so some copies must be redone.</p>	<p>The settings are stored in a job program, so they can be selected by the touch of a key. This is simple and takes no time. In addition, the settings are all stored so there are no chances for mistakes, and thus no need to redo copies due to setting mistakes.</p>																

- Up to 48 job programs can be stored. The job programs are retained even if an interruption occurs in the power supply.
- Job programs can also be stored in the Web pages. Click [Job program] and then [Copy] in the Web page menu to store a job program.

# STORING (EDITING/DELETING) A JOB PROGRAM

The procedures for storing copy settings in a job program and deleting a job program are explained below.

1

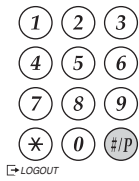

**Press the [#/P] key.**

2

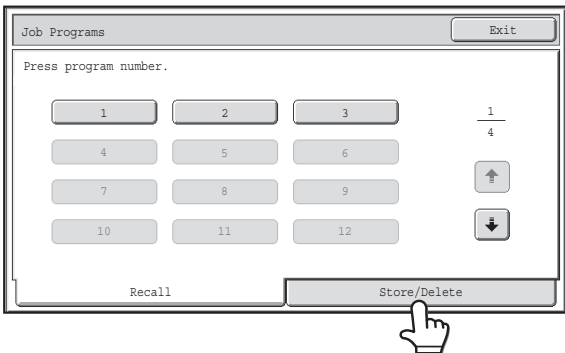

**Touch the [Store/Delete] tab.**

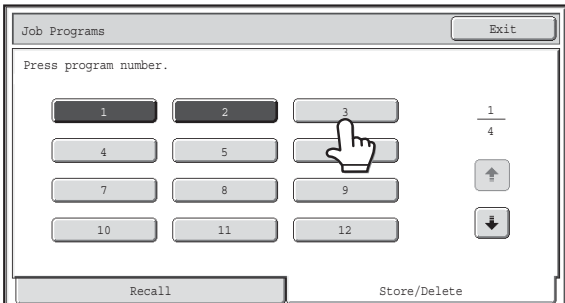

**Touch a numeric key.**

Numeric keys in which job programs are already stored are highlighted.

- To store a job program, touch a numeric key that is not highlighted.
- To edit or delete a job program, touch the key in which the job program is stored (highlighted key).

3



**Editing or deleting a job program...**

When a highlighted numeric key is touched, the following screen appears.

The [Store] key can be touched to delete the stored settings and store new settings. Go to the next step.

When the [Delete] key is touched, the stored settings are deleted. After the deletion is finished, touch the [Exit] key to return to the base screen.

A job program has been already stored in this location.

Cancel
Delete
Store

When "Disabling Deletion of Job Programs" is enabled in the system settings, a stored job program cannot be edited or deleted.

4

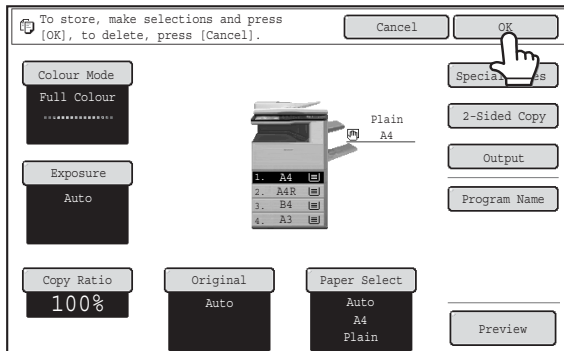

**Select the copy settings that you wish to store in the job program and touch the [OK] key.**

To assign a name to the program, touch the [Program Name] key. A text entry screen will appear.

Up to 10 characters can be entered for the name.

When you have finished, touch the [OK] key.

You will return to the base screen with the stored information reflected in the screen.



The number of copies cannot be stored.

# APPENDIX

## Examples of covers and inserts

The relations between the originals and finished copies when covers or inserts are inserted are shown on the following pages.

### Covers

- 1-sided copying of 1-sided originals
- 1-sided copying of 2-sided originals
- 2-sided copying of 1-sided originals
- 2-sided copying of 2-sided originals

### Inserts

- 1-sided copying of 1-sided originals
- 1-sided copying of 2-sided originals
- 2-sided copying of 1-sided originals
- 2-sided copying of 2-sided originals

## Symbols used for covers and inserts

The following symbols are used to make the explanations easier to understand.



















The numbers that appear indicate what original a copy corresponds to, and will vary depending on the settings.

Type	Symbol	Meaning	Icon appearing in display	Type	Symbol	Meaning	Icon appearing in display
Front cover		Front cover when not copied on.		Inserts		Insert when not copied on.	
		Front cover when one side is copied on.				Insert when one side is copied on.	
		Front cover when a 2-sided original is copied on one side of the cover. (One page is not copied.)				Insert when a 2-sided original is copied on one side of the insert. (One page is not copied.)	
		Front cover when both sides are copied on.				Insert when both sides are copied on.	
Back cover		Back cover when not copied on.		Other symbols		1-sided original or output page of regular 1-sided copying.	
		Back cover when a 1-sided original is copied on one side of the back cover.				2-sided original or output page of regular 2-sided copying.	
		Back cover when a 2-sided original is copied on one side of the back cover. (One page is not copied.)				1-sided original or output page of regular 1-sided copying.	
		Back cover when both sides are copied on.				Output page of 2-sided copying when only 1 side is copied on due to lack of originals.	

## Covers (1-sided copying of 1-sided originals)

1-sided copies are made of the following 1-sided originals.







































1st page	2nd page	3rd page	4th page	5th page	6th page
1	2	3	4	5	6

Cover copying condition		Resulting copies							
Front cover	Back cover								
No copying	No copying		1	2	3	4	5	6	
1-sided copying	No copying		2	3	4	5	6		
2-sided copying	No copying		3	4	5	6			
No copying	1-sided copying		1	2	3	4	5		
No copying	2-sided copying		1	2	3	4			
1-sided copying	1-sided copying		2	3	4	5			
1-sided copying	2-sided copying		2	3	4				
2-sided copying	1-sided copying		3	4	5				
2-sided copying	2-sided copying		3	4					

## Covers (2-sided copying of 1-sided originals)



2-sided copies are made of the following 1-sided originals.























































1st page	2nd page	3rd page	4th page	5th page	6th page
1	2	3	4	5	6

Cover copying condition		Resulting copies				
Front cover	Back cover					
No copying	No copying					
1-sided copying	No copying					
2-sided copying	No copying					
No copying	1-sided copying					
No copying	2-sided copying					
1-sided copying	1-sided copying					
1-sided copying	2-sided copying					
2-sided copying	1-sided copying					
2-sided copying	2-sided copying					

## Covers (1-sided copying of 2-sided originals)



1-sided copies are made of the following 2-sided originals.

































1st page	2nd page	3rd page
		

Cover copying condition		Resulting copies							
Front cover	Back cover								
No copying	No copying								
1-sided copying	No copying								
2-sided copying	No copying								
No copying	1-sided copying								
No copying	2-sided copying								
1-sided copying	1-sided copying								
1-sided copying	2-sided copying								
2-sided copying	1-sided copying								
2-sided copying	2-sided copying								

## Covers (2-sided copying of 2-sided originals)

2-sided copies are made of the following 2-sided originals.

1st page	2nd page	3rd page
		

Cover copying condition		Resulting copies
Front cover	Back cover	
No copying	No copying	    
1-sided copying	No copying	   
2-sided copying	No copying	   
No copying	1-sided copying	   
No copying	2-sided copying	   
1-sided copying	1-sided copying	  
1-sided copying	2-sided copying	  
2-sided copying	1-sided copying	  
2-sided copying	2-sided copying	  



## Inserts (copying of 1-sided originals)

1-sided and 2-sided copying of the following 1-sided originals. The example of adding an insert at the 3rd sheet is shown. (when "Insertion Page" is set to "3" in the insertion settings of the insert settings in the special modes)

1st page	2nd page	3rd page	4th page	5th page	6th page

Insert copying condition	Resulting copies (1-sided copying)							Resulting copies (2-sided copying)				
No copying												
1-sided copying												
2-sided copying												

## Inserts (copying of 2-sided originals)

1-sided and 2-sided copying of the following 2-sided originals. The example of adding an insert at the 3rd sheet is shown. (when "Insertion Page" is set to "3" in the insertion settings of the insert settings in the special modes)

1st page	2nd page	3rd page

Insert copying condition	Resulting copies (1-sided copying)							Resulting copies (2-sided copying)				
No copying												
1-sided copying												
2-sided copying												

# CHAPTER 3

# PRINTER

This chapter provides detailed explanations of the procedures for using the printer function.

## PRINTER FUNCTION OF THE MACHINE..... 3-3

### PRINTING FROM WINDOWS

#### BASIC PRINTING PROCEDURE..... 3-4

- SELECTING THE PAPER ..... 3-6
- PRINTING ON ENVELOPES ..... 3-7

#### PRINTING WHEN THE USER AUTHENTICATION FUNCTION IS ENABLED .... 3-8

#### VIEWING PRINTER DRIVER HELP..... 3-11

#### SAVING FREQUENTLY USED PRINT SETTINGS ..... 3-12

- SAVING SETTINGS AT THE TIME OF PRINTING ..... 3-12
- USING SAVED SETTINGS ..... 3-14

#### CHANGING THE PRINTER DRIVER DEFAULT SETTINGS ..... 3-15

### PRINTING FROM A MACINTOSH

#### BASIC PRINTING PROCEDURE..... 3-17

- SELECTING PAPER SETTINGS..... 3-17
- PRINTING ..... 3-18
- SELECTING THE PAPER ..... 3-20
- PRINTING ON ENVELOPES ..... 3-21

#### PRINTING WHEN THE USER AUTHENTICATION FUNCTION IS ENABLED ... 3-22

### FREQUENTLY USED FUNCTIONS

#### SELECTING THE COLOUR MODE..... 3-24

#### SELECTING A PRINT MODE SETTING ..... 3-26

#### TWO-SIDED PRINTING ..... 3-27

#### FITTING THE PRINT IMAGE TO THE PAPER ... 3-29

#### PRINTING MULTIPLE PAGES ON ONE PAGE ..... 3-30

#### STAPLING OUTPUT/PUNCHING HOLES IN OUTPUT ..... 3-33

## CONVENIENT PRINTING FUNCTIONS

### CONVENIENT FUNCTIONS FOR CREATING PAMPHLETS AND POSTERS..... 3-35

- CREATING A PAMPHLET (Pamphlet)..... 3-35
- INCREASING THE MARGIN (Margin Shift) ... 3-37
- CREATING A LARGE POSTER (Poster Printing) ..... 3-38

### FUNCTIONS TO ADJUST THE SIZE AND ORIENTATION OF THE IMAGE..... 3-39

- ROTATING THE PRINT IMAGE 180 DEGREES (Rotate 180 degrees)..... 3-39
- ENLARGING/REDUCING THE PRINT IMAGE (Zoom/XY-Zoom) ..... 3-40
- ADJUSTING LINE WIDTHS WHEN PRINTING (Line Width Settings) ..... 3-41
- REVERSING THE IMAGE (Mirror Image) .... 3-42

### COLOUR MODE ADJUSTMENT FUNCTION .... 3-43

- ADJUSTING THE BRIGHTNESS AND CONTRAST OF THE IMAGE (Colour Adjustment) ..... 3-43
- PRINTING FAINT TEXT AND LINES IN BLACK (Text To Black/Vector To Black) ..... 3-44
- SELECTING COLOUR SETTINGS TO MATCH THE IMAGE TYPE (Advanced Colour) ..... 3-45

### FUNCTIONS THAT COMBINE TEXT AND IMAGES ..... 3-47

- ADDING A WATERMARK TO PRINTED PAGES (Watermark) ..... 3-47
- PRINTING AN IMAGE OVER THE PRINT DATA (Image Stamp)..... 3-48
- CREATING OVERLAYS FOR PRINT DATA (Overlays) ..... 3-49



**PRINT FUNCTIONS FOR SPECIAL PURPOSES . . . . . 3-50**

- PRINTING SPECIFIED PAGES ON DIFFERENT PAPER (Different Paper) . . . . . 3-50
- ADDING INSERTS WHEN PRINTING ON TRANSPARENCY FILM (Transparency Inserts) . . . . . 3-52
- PRINTING A CARBON COPY (Carbon Copy) . . . . . 3-53
- PRINTING TEXT ON TABS OF TAB PAPER (Tab Paper Print/Tab Paper Settings) . . . . . 3-54
- TWO-SIDED PRINTING WITH SPECIFIC PAGES PRINTED ON THE FRONT SIDE (Chapter Inserts) . . . . . 3-57

**CONVENIENT PRINTER FUNCTIONS . . . . . 3-58**

- USING TWO MACHINES TO PRINT A LARGE PRINT JOB (Tandem Print) . . . . . 3-58
- SAVING AND USING PRINT FILES (Retention/Document Filing) . . . . . 3-59

**PRINTING WITHOUT THE PRINTER DRIVER**

**DIRECTLY PRINTING FROM THE MACHINE. . . . . 3-62**

- DIRECTLY PRINTING A FILE ON AN FTP SERVER . . . . . 3-63
- DIRECTLY PRINTING A FILE IN USB MEMORY . . . . . 3-64
- DIRECTLY PRINTING A FILE IN A NETWORK FOLDER . . . . . 3-66

**DIRECTLY PRINTING FROM A COMPUTER . . . . . 3-69**

- SUBMIT PRINT JOB . . . . . 3-69
- FTP PRINT . . . . . 3-69
- E-MAIL PRINT . . . . . 3-70

**CHECKING THE PRINT STATUS**

**JOB STATUS SCREEN . . . . . 3-71**

- SPOOL SCREEN/JOB QUEUE SCREEN/COMPLETED JOB SCREEN . . . . . 3-72

**PRINTING AN ENCRYPTED PDF FILE . . . . . 3-74**

**GIVING A PRINT JOB PRIORITY/CANCELLING A PRINT JOB . . . . . 3-75**

- GIVING A PRINT JOB PRIORITY . . . . . 3-75
- CANCELLING A PRINT JOB . . . . . 3-76

**CHANGING TO ANOTHER PAPER SIZE AND PRINTING WHEN PAPER RUNS OUT . . . . . 3-77**

**APPENDIX**

**PRINTER DRIVER SPECIFICATION LIST . . . . . 3-78**

**PRINTER SPECIFICATIONS . . . . . 3-80**

# PRINTER FUNCTION OF THE MACHINE

The machine is equipped standard with a full colour printing function. To enable printing from your computer, a printer driver must be installed.

See the table below to determine which printer driver to use in your environment.

Environment	Printer driver type	Remarks
Windows	<b>Sharp Advanced Printing Language-c</b> This is the SHARP proprietary printer driver. The printer driver compresses the data in each print job before sending the job to the machine, enabling smooth printing.	Can be used in the standard machine configuration.*
	<b>PCL6</b> The machine supports the Hewlett-Packard PCL6 printer control languages.	Can be used in the standard configuration. However, some functions will not work unless the Productivity Kit is installed.
	<b>PS</b> This printer driver supports the PostScript 3 page description language developed by Adobe Systems Incorporated, and enables the machine to be used as a PostScript 3 compatible printer. (A PPD file is available if it is desired to use the Windows standard PS printer driver.)	The PS3 expansion kit is required.
Macintosh		

\* Cannot be used when the productivity kit is installed.

## Installing the printer driver in a Windows environment

To install the printer driver and configure settings in a Windows environment, see "2. SETUP IN A WINDOWS ENVIRONMENT" in the Software Setup Guide.

 The explanations in this manual of printing in a Windows environment generally use the screens of the PCL6 printer driver. The printer driver screens may differ slightly depending on the printer driver that you are using.

## Installing the printer driver in a Macintosh environment

In a Macintosh environment, the PS3 expansion kit must be installed to use the machine as a network printer. To install the printer driver and configure settings in a Macintosh environment, see "3. SETUP IN A MACINTOSH ENVIRONMENT" in the Software Setup Guide.

# PRINTING FROM WINDOWS

## BASIC PRINTING PROCEDURE

The following example explains how to print a document from "WordPad", which is a standard accessory program in Windows.

1

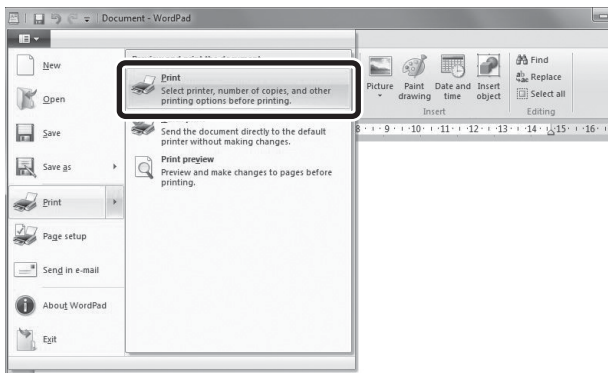

Select [Print] from the  button of WordPad.

If you are using Windows XP/Server 2003/Vista, click the [File] menu.



The menu used to execute printing may vary depending on the software application.

2

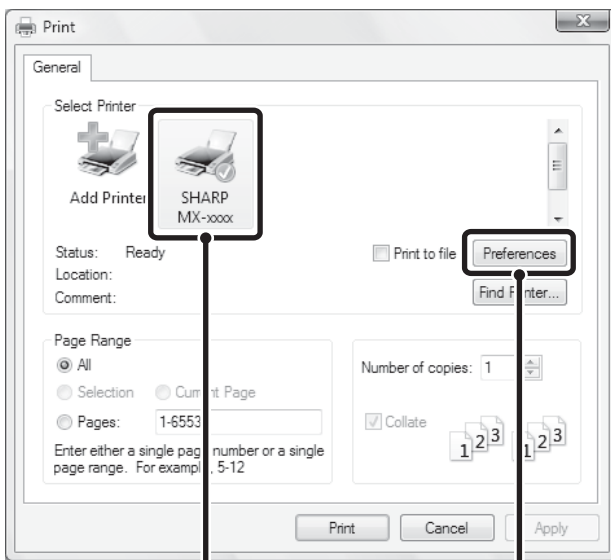

Open the printer driver properties window.

- (1) Select the printer driver of the machine.
  - If the printer drivers appear as icons, click the icon of the printer driver to be used.
  - If the printer drivers appear as a list, select the name of the printer driver to be used from the list.
- (2) Click the [Preferences] button.



The button that is used to open the printer driver properties window (usually [Properties] or [Printing Preferences]) may vary depending on the software application.

3

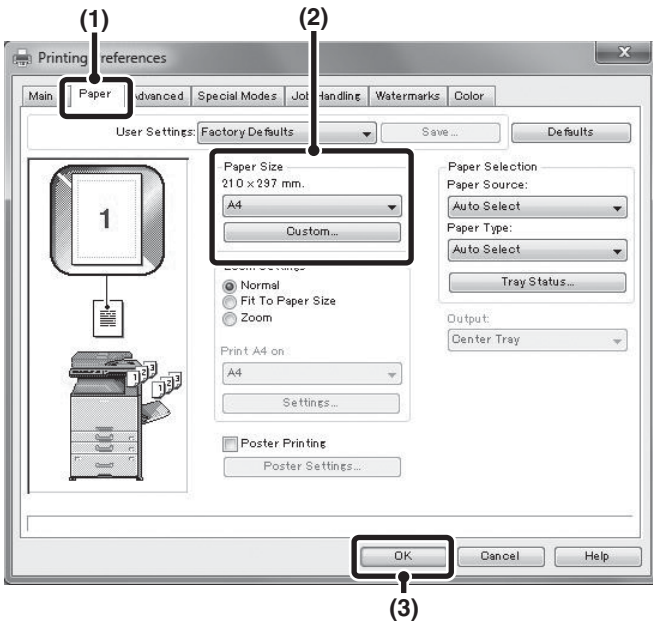

**Select print settings.**

(1) Click the [Paper] tab.

(2) Select the paper size.

To select settings on other tabs, click the desired tab and then select the settings.

(3) Click the [OK] button.



- Make sure the paper size is the same as the paper size set in the software application.
- Up to nine custom paper sizes can be stored. Storing a custom paper size makes it easy to specify that size each time you need to use it.  
To store a paper size, select [Custom Paper], one of [User1] to [User7] or [Long Paper]\* from the pull-down menu and click the [Custom] button.  
\* PCL6 only

4

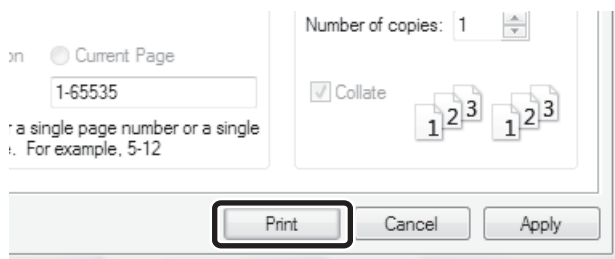

**Click the [Print] button.**

Printing begins.

# SELECTING THE PAPER

This section explains how to configure the "Paper Selection" setting on the [Paper] tab of the printer driver properties window.

Before printing, check the paper sizes, paper types, and paper remaining in the machine's trays. To view the most recent tray information, click the [Tray Status] button.

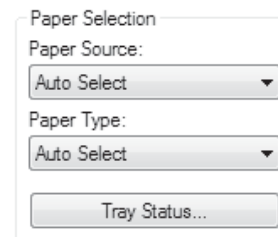

- **When [Auto Select] is selected in "Paper Source"**

The tray that has the size and type of paper selected in "Paper Size" and "Paper Type" on the [Paper] tab is automatically selected.

- **When other than [Auto Select] is selected in "Paper Source"**

The specified tray is used for printing regardless of the "Paper Size" setting.

- **When [Bypass Tray] is selected**

The "Paper Type" must also be selected. Check the bypass tray and make sure that the desired type of paper is loaded, and then select the appropriate "Paper Type" setting.



- Special media such as envelopes can also be placed in the bypass tray. For the procedure for loading paper and other media in the bypass tray, see "[LOADING PAPER IN THE BYPASS TRAY](#)" (page 1-35) in "1. BEFORE USING THE MACHINE".
- When "Enable Detected Paper Size in Bypass Tray" (disabled by factory default) or "Enable Selected Paper Type in Bypass Tray" (enabled by factory default) is enabled in the system settings (administrator), printing will not take place if the paper size or paper type specified in the printer driver is different from the paper size or paper type specified in the settings of the bypass tray.

- **When [Auto Select] is selected in "Paper Type"**

A tray with plain paper or recycled paper of the size specified in "Paper Size" is automatically selected. (The factory default setting is plain paper only.)

- **When other than [Auto Select] is selected in "Paper Type"**

A tray with the specified type of paper and the size specified in "Paper Size" is used for printing.



**System Settings (Administrator): Exclude Bypass-Tray from Auto Paper Select**

When [Auto Select] is selected in "Paper Selection", specify whether or not the paper in the bypass tray will be excluded from the paper that can be selected. This setting is disabled by factory default, and thus paper in the bypass tray is included in the paper that can be automatically selected. If special media are frequently loaded in the bypass tray, it is recommended that this setting be enabled.

# PRINTING ON ENVELOPES

The bypass tray can be used to print on special media such as envelopes. The procedure for printing on an envelope from the printer driver properties screen is described below.

For the types of paper that can be used in the bypass tray, see "[IMPORTANT POINTS ABOUT PAPER](#)" (page 1-27) in "BEFORE USING THE MACHINE". For the procedure for loading paper in the bypass tray, see "[LOADING PAPER IN THE BYPASS TRAY](#)" (page 1-35) in "1. BEFORE USING THE MACHINE".

Select the envelope size in the appropriate settings of the application ("Page Settings" in many applications) and then perform the following steps.

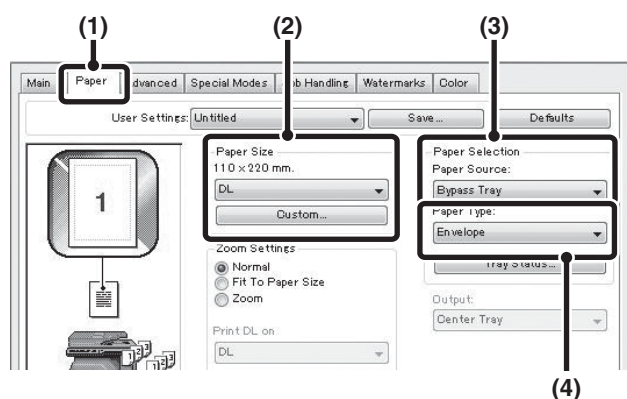

- (1) Click the [Paper] tab.
- (2) Select the envelope size from the "Paper Size" menu.
- (3) Select [Bypass Tray] from the "Paper Source" menu of "Paper Selection".
- (4) Select [Envelope] from the "Paper Type" menu.

Set the paper type of the bypass tray to [Envelope] and make sure the envelope is loaded in the bypass tray.

- ✎ It is recommended that you do a test print to check the print result before using an envelope.
- ✎ In the case of media that can only be loaded in a certain orientation such as an envelope, you can rotate the image 180 degrees if needed. For more information, see "[ROTATING THE PRINT IMAGE 180 DEGREES \(Rotate 180 degrees\)](#)" (page 3-39).
- ✎ For more information on "Paper Selection", see "[SELECTING THE PAPER](#)" (page 3-6).





2

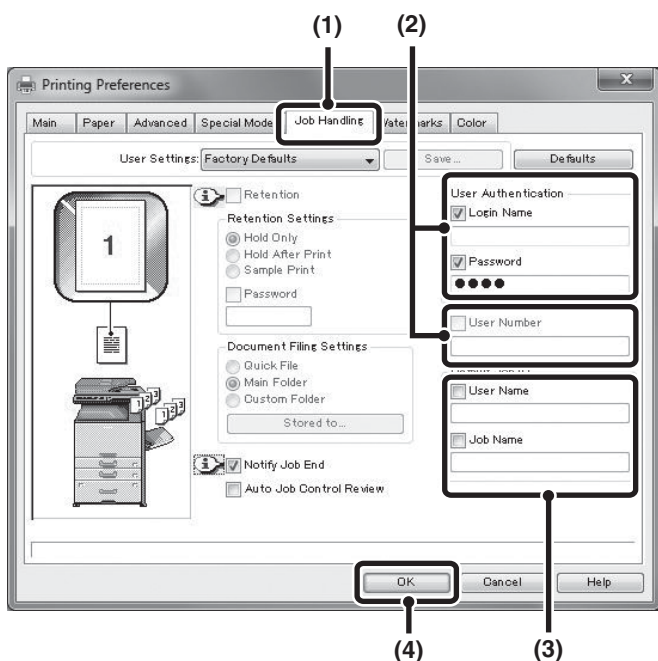

## Enter your login name and password.

(1) Click the [Job Handling] tab.

(2) Enter your user information.

- **When authentication is by login name/password**  
Select the [Login Name] and [Password] checkboxes so that checkmarks  appear, and enter your login name and password. Enter 1 to 32 characters for the password.
- **When authentication is by user number**  
Click the [User Number] checkbox  and enter a user number (5 to 8 digits).



When [User Authentication] has been checked on [Printing Policy] in the [Configuration] tab, you cannot enter the user information. Enter the user information in the dialog box whenever you print.

(3) Enter the user name and job name as necessary.

- **User Name**  
Click the [User Name] checkbox  and enter your user name (maximum of 32 characters). Your entered user name will appear at the top of the operation panel. If you do not enter a user name, your computer login name will appear.
- **Job Name**  
Click the [Job Name] checkbox  and enter a job name (maximum of 30 characters). The entered job name will appear at the top of the operation panel as a file name. If you do not enter a job name, the file name set in the software application will appear.

(4) Click the [OK] button.



To have a confirmation window appear before printing starts, select the [Auto Job Control Review] checkbox so that a checkmark  appears.

3

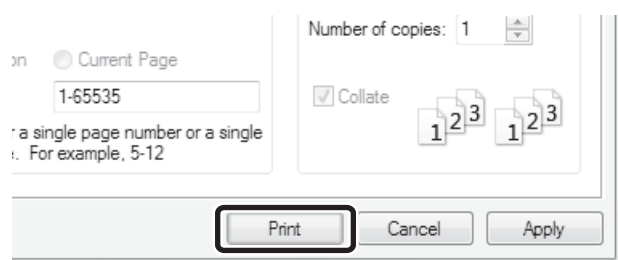

## Start printing.



- When user authentication is enabled in the system settings (administrator), printing is possible without entering user information if black and white printing is set in the printer driver. For black and white print settings, see "[BLACK AND WHITE PRINTING](#)" (page 3-25). The number of pages printed is added to the "Other User" count. In this case, other print functions may be restricted. For more information, ask your administrator.
- The machine's user authentication function cannot be used when the PPD file\* is installed and the Windows standard PS printer driver is used. For this reason, printing will not be possible if printing by invalid users is prohibited in the system settings (administrator).
  - \* The PPD file enables the machine to print using the standard PS printer driver of the operating system.

**System Settings (Administrator): Disabling of Printing by Invalid User**

This is used to prohibit printing of print jobs by users whose user information is not stored in the machine. When this function is enabled, printing is not allowed when user information is not entered or incorrect information is entered.

# VIEWING PRINTER DRIVER HELP

When selecting settings in the printer driver, you can display Help to view explanations of the settings.

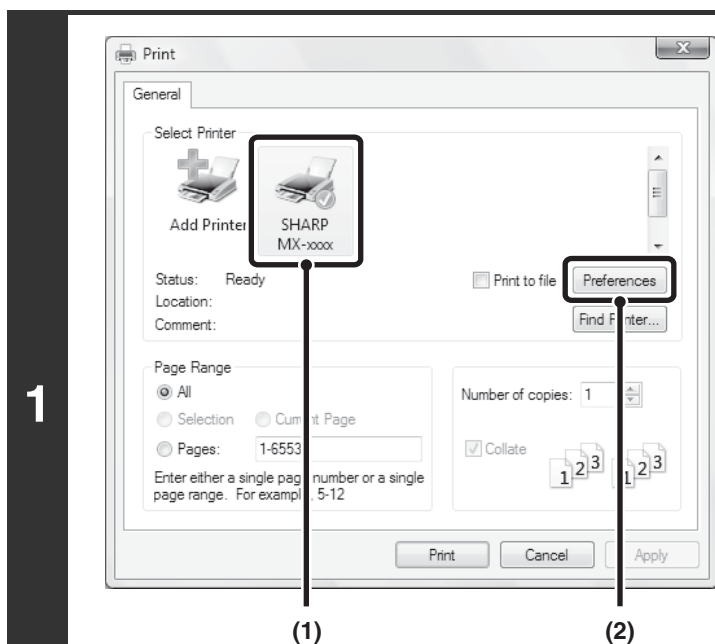

Open the printer driver properties window from the print window of the software application.

- (1) Select the printer driver of the machine.
- (2) Click the [Preferences] button.

 The button that is used to open the printer driver properties window (usually [Properties] or [Printing Preferences]) may vary depending on the software application.

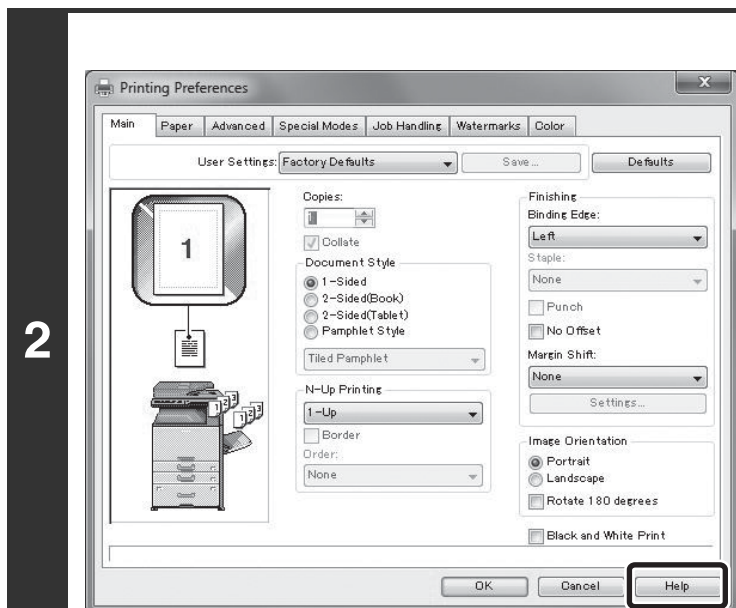

Click the [Help] button.

The Help window will open to let you view explanations of the settings on the tab.

To view Help for settings in a dialog box, click the underlined text at the top of the Help window.

## Pop-up help

Help can be displayed for a setting by clicking the setting and pressing the [F1] key.

\* To view Help for a setting in Windows XP/Server 2003, click the  button in the upper right-hand corner of the printer driver properties window and then click the setting.

## Information icon

Some restrictions exist on the combinations of settings that can be selected in the printer driver properties window. When a restriction exists on a selected setting, an information icon () will appear next to the setting. Click the icon to view an explanation of the restriction.

# SAVING FREQUENTLY USED PRINT SETTINGS

Settings configured on each of the tabs at the time of printing can be saved as user settings. Saving frequently used settings or complex colour settings under an assigned name makes it easy to select those settings the next time you need to use them.

## SAVING SETTINGS AT THE TIME OF PRINTING

Settings can be saved from any tab of the printer driver properties window. Settings configured on each tab are listed at the time of saving, allowing you to check the settings as you save them.

1

**Open the printer driver properties window from the print window of the software application.**

- (1) Select the printer driver of the machine.
- (2) Click the [Preferences] button.

---

✎

The button that is used to open the printer driver properties window (usually [Properties] or [Printing Preferences]) may vary depending on the software application.

2

**Save the print settings.**

- (1) Configure print settings on each tab.
- (2) Click the [Save] button.

3

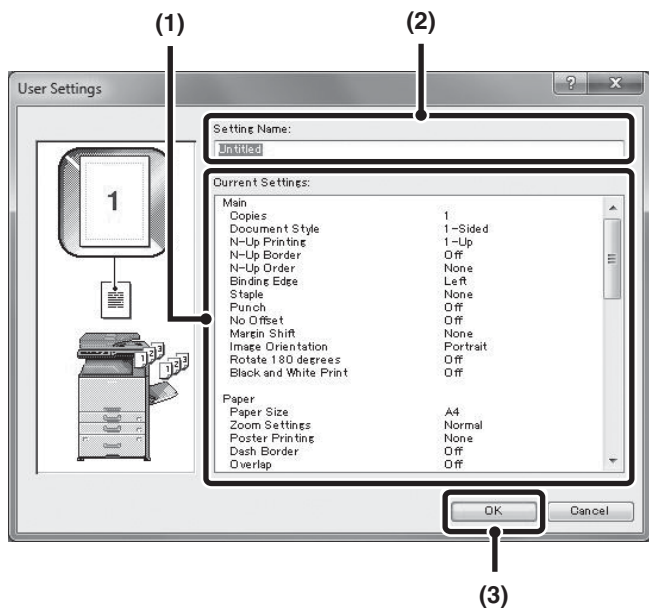

**Check and save the settings.**

- (1) Check the displayed settings.
- (2) Enter a name for the settings (maximum of 20 characters).
- (3) Click the [OK] button.

4



**Click the [OK] button.**

5

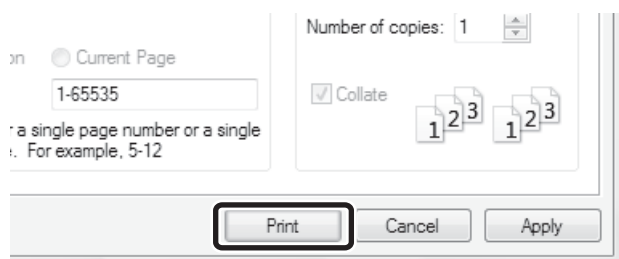

**Start printing.**



- Up to 30 sets of user settings can be saved.
- The following items cannot be saved in user settings.
  - A watermark that you created
  - Paper insertion settings
  - Overlay file (PCL6 or PS only)
  - [Tab Paper Print] settings on the [Special Modes] tab (PCL6 only)
  - The login name, password, user name, and job name entered in the [Job Handling] tab

# USING SAVED SETTINGS

1

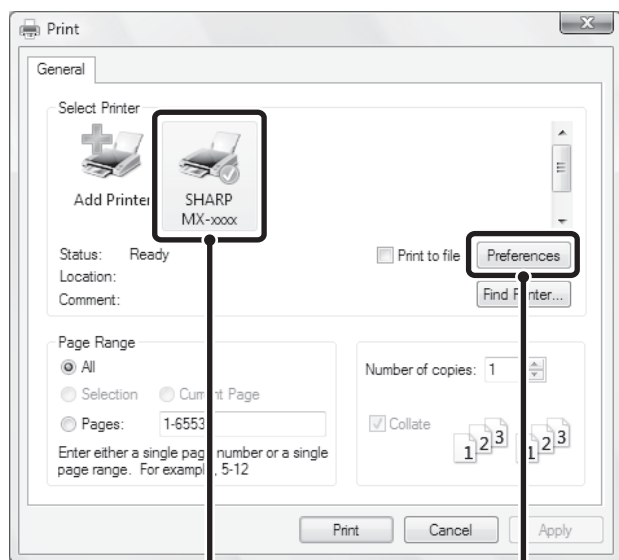

(1)

(2)

Open the printer driver properties window from the print window of the software application.

- (1) Select the printer driver of the machine.
- (2) Click the [Preferences] button.



The button that is used to open the printer driver properties window (usually [Properties] or [Printing Preferences]) may vary depending on the software application.

2

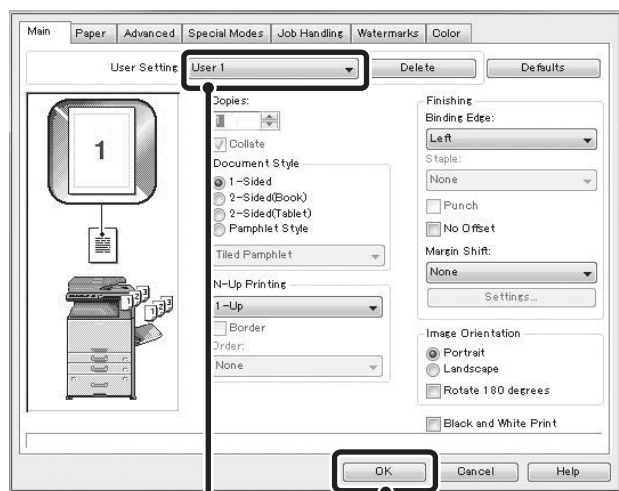

(1)

(2)

Select the print settings.

- (1) Select the user settings that you wish to use.
- (2) Click the [OK] button.

3

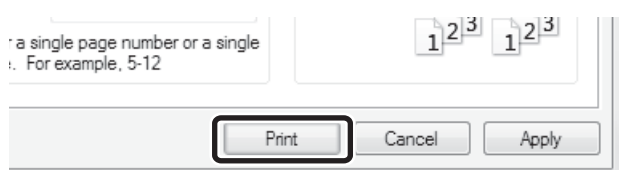

Start printing.

## Deleting saved settings

Select the user settings that you want to delete in (1) of step 2 above, and click the [Delete] button.

# CHANGING THE PRINTER DRIVER DEFAULT SETTINGS

The default settings of the printer driver can be changed using the procedure below. The settings selected using this procedure are saved and become the default settings when printing from a software application. (Settings selected in the printer driver properties window when printing from an application remain in effect only while the application is in use.)

1

## Click the [Start] button (🌐) and then click [Devices and Printers].

- In Windows Vista, click the [start] button and select [Control Panel] and then [Printer].
- In Windows XP/Server 2003, click the [start] button and then click [Printers and Faxes].
- For Windows 8, right-click in the startup window (or swipe upward from the bottom edge), then click [Taskbar] → [All Applications] → [Control Panel] → [Devices and Printers].



In Windows XP, if [Printers and Faxes] does not appear in the [start] menu, select [Control Panel], select [Printers and Other Hardware], and then select [Printers and Faxes].

2

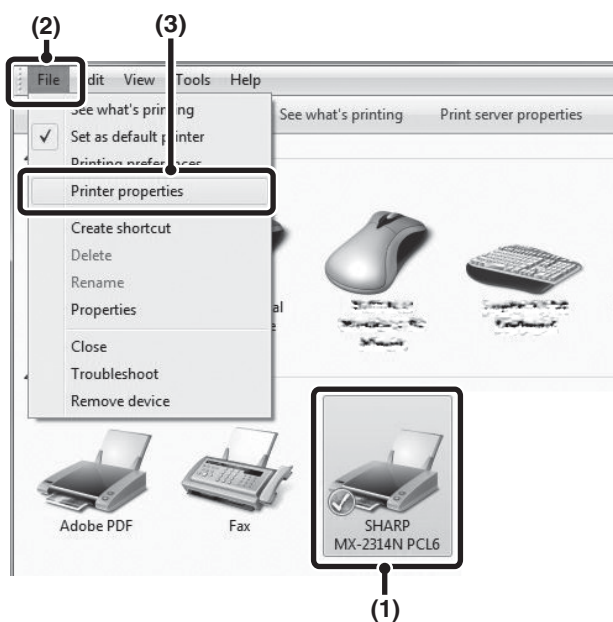

## Open the printer properties window.

### (1) Click the icon of the printer driver of the machine.

In Windows 8, right-click the icon of the printer driver of the machine. Go to step (3).

### (2) Click the [File] menu.

In Windows Vista, click the [Organize] menu.

### (3) Select [Printer properties].

In Windows XP/Server 2003/Vista, click the [Properties] menu.



3

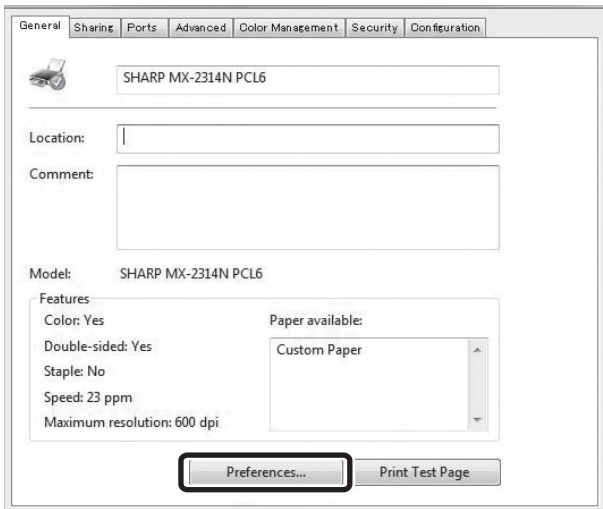

Click the [Preferences] button on the [General] tab.

In Windows XP/Server 2003/Vista, click the [Printing Preferences] button on the [General] tab.

4

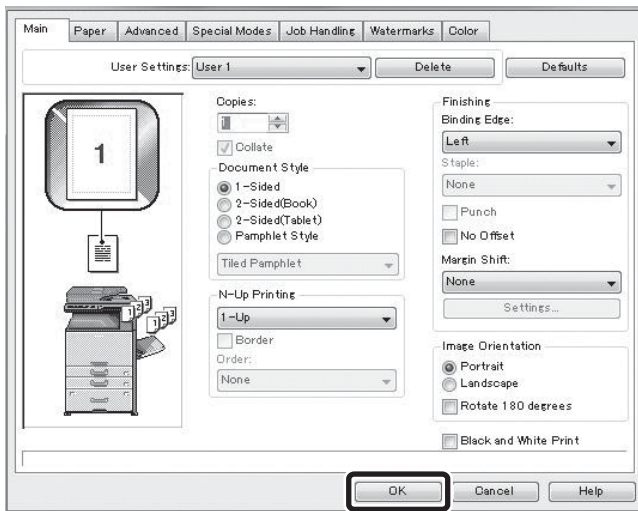

Configure the settings and click the [OK] button.

For explanations of the settings, see printer driver Help.

# PRINTING FROM A MACINTOSH

## BASIC PRINTING PROCEDURE

The following example explains how to print a document from the standard accessory program "TextEdit" in Mac OS X.

 To use the machine as a printer for the Macintosh, the PS3 expansion kit must be installed in the machine and the machine must be connected to a network. To install the PPD file and configure printer driver settings, see "3. SETUP IN A MACINTOSH ENVIRONMENT" in the Software Setup Guide.

## SELECTING PAPER SETTINGS

Select paper settings in the printer driver before selecting the print command.

1

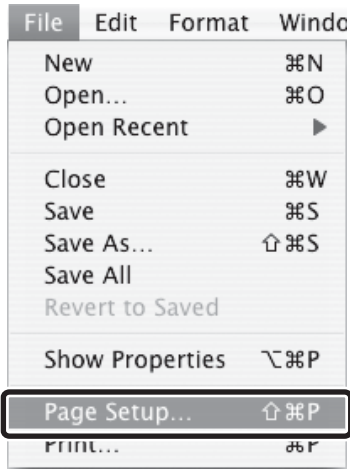

The screenshot shows the 'File' menu of the TextEdit application. The menu items are: New (⌘N), Open... (⌘O), Open Recent (with a submenu arrow), Close (⌘W), Save (⌘S), Save As... (⇧⌘S), Save All, Revert to Saved, Show Properties (⇧⌘P), Page Setup... (⇧⌘P), and Print... (⌘P). The 'Page Setup...' option is highlighted with a dark grey background.

**Select [Page Setup] from the [File] menu of TextEdit.**

2

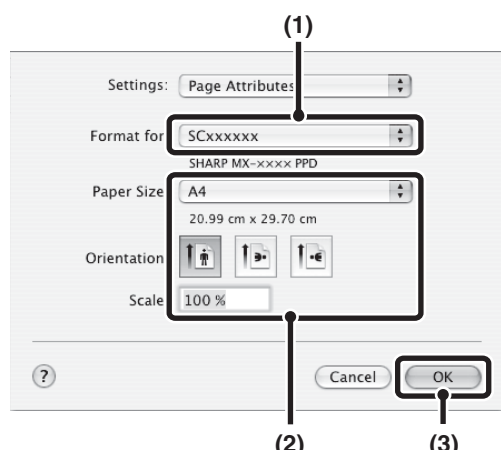

The screenshot shows the 'Page Attributes' dialog box. Callout (1) points to the 'Settings' dropdown menu. Callout (2) points to the 'Format for' dropdown menu, which shows 'SCxxxxxx' and 'SHARP MX-xxxx PPD'. Callout (3) points to the 'OK' button. Other visible options include 'Paper Size' (A4, 20.99 cm x 29.70 cm), 'Orientation' (Portrait, Landscape, and a third icon), and 'Scale' (100%).

**Select paper settings.**

- (1) Make sure that the correct printer is selected.
- (2) Select paper settings.  
The paper size, paper orientation, and enlarge/reduce can be selected.
- (3) Click the [OK] button.

 The machine name that appears in the "Format for" menu is normally [SCxxxxxx]. ("xxxxxx" is a sequence of characters that varies depending on your machine model.)

# PRINTING

1

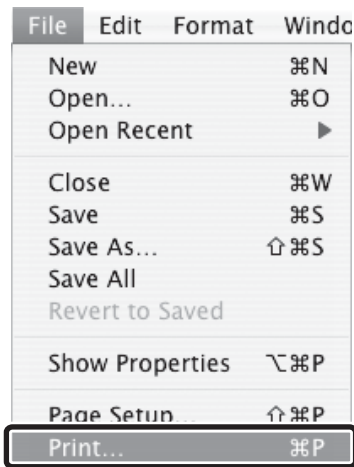

Select [Print] from the [File] menu of TextEdit.



The menu used to execute printing may vary depending on the software application.

2

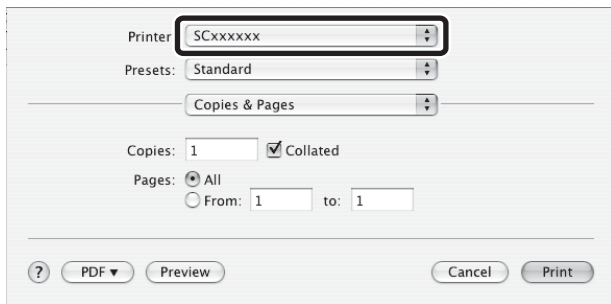

Make sure that the correct printer is selected.



The machine name that appears in the "Printer" menu is normally [SCxxxxxx]. ("xxxxxx" is a sequence of characters that varies depending on the machine model.)

3

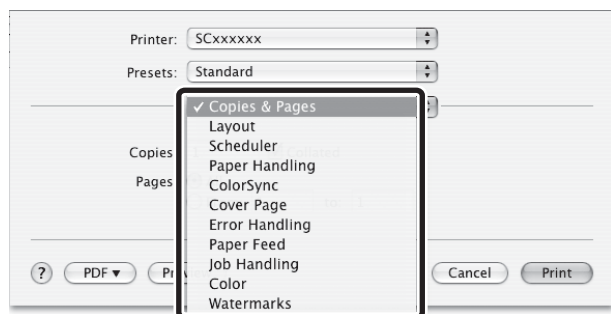

Select print settings.

Click [dropdown arrow] next to [Copies & Pages] and select the settings that you wish to configure from the pull-down menu. The corresponding setting screen will appear. If the settings do not appear in Mac OS X v10.5, 10.6, 10.7 and 10.8, click [dropdown arrow] next to the printer name.

4

Printer: SCxxxxxx  
Presets: Standard  
Copies & Pages  
Copies: 1  Collated  
Pages:  All  
 From: 1 to: 1  
Buttons: ? PDF Preview Cancel **Print**

**Click the [Print] button.**  
Printing begins.

# SELECTING THE PAPER

This section explains the [Paper Feed] settings in the print settings window.

- **When [Auto Select] is selected**

A tray with plain paper or recycled paper (the factory default setting is plain paper only) of the size specified in "Paper Size" in the page settings window is automatically selected.

- **When a paper tray is selected**

The specified tray is used for printing regardless of the "Paper Size" setting in the page settings window.

For the bypass tray, a paper type can also be specified. Make sure that the paper type setting for the bypass tray is correct and that the set type of paper is actually loaded in the bypass tray, and then select the appropriate bypass tray (paper type).



- Special media such as envelopes can also be placed in the bypass tray. For the procedure for loading paper and other media in the bypass tray, see "[LOADING PAPER IN THE BYPASS TRAY](#)" (page 1-35) in "1. BEFORE USING THE MACHINE".
- When "Enable Detected Paper Size in Bypass Tray" (disabled by factory default) or "Enable Selected Paper Type in Bypass Tray" (enabled by factory default) is enabled in the system settings (administrator), printing will not take place if the paper size or paper type specified in the printer driver is different from the paper size or paper type specified in the settings of the bypass tray.

- **When a paper type is selected**

A tray with the specified type of paper and the size specified in "Paper Size" in the page settings window is used for printing.



**System Settings (Administrator): Exclude Bypass-Tray from Auto Paper Select**

When [Auto Select] is used for printing, this setting determines whether or not the paper in the bypass tray will be excluded from the paper that can be selected. This setting is disabled by factory default, and thus paper in the bypass tray is included in the paper that can be automatically selected. If special media are frequently loaded in the bypass tray, it is recommended that this setting be enabled.

# PRINTING ON ENVELOPES

The bypass tray can be used to print on special media such as envelopes. The procedure for printing on an envelope from the printer driver properties screen is described below.

For the types of paper that can be used in the bypass tray, see ["IMPORTANT POINTS ABOUT PAPER"](#) (page 1-27) in ["BEFORE USING THE MACHINE"](#). For the procedure for loading paper in the bypass tray, see ["LOADING PAPER IN THE BYPASS TRAY"](#) (page 1-35) in ["1. BEFORE USING THE MACHINE"](#).

Select the envelope size in the appropriate settings of the application ("Page Settings" in many applications) and then perform the following steps.

1

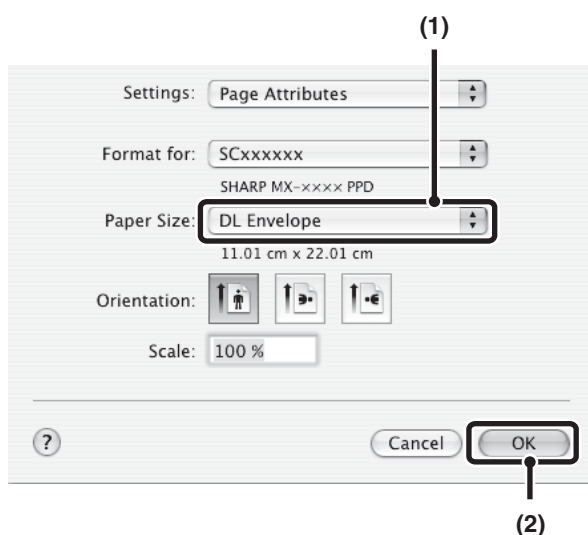

## Select the paper size.

- (1) Select the envelope size from the "Paper Size" menu on the page setup screen.
- (2) Click the [OK] button.

 In the case of media that can only be loaded in a certain orientation such as an envelope, you can rotate the image 180 degrees if needed. For more information, see ["ROTATING THE PRINT IMAGE 180 DEGREES \(Rotate 180 degrees\)"](#) (page 3-39).

2

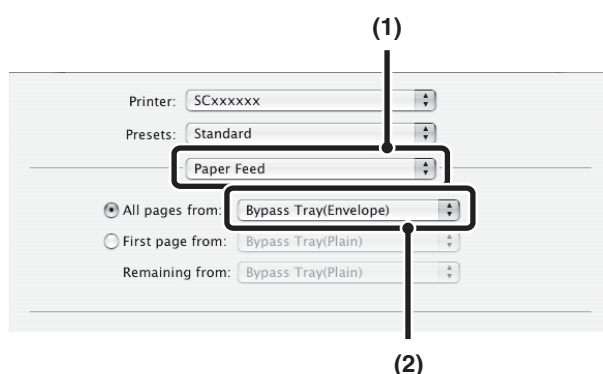

## Select the bypass tray.

- (1) Select [Paper Feed] on the print screen.
- (2) Select [Bypass Tray(Envelope)] from the "All pages from" menu.

Set the paper type of the bypass tray to [Envelope] and make sure the envelope is loaded in the bypass tray.

 For more information on "Paper Feed", see ["SELECTING THE PAPER"](#) (page 3-20).

 It is recommended that you do a test print to check the print result before using an envelope.

# PRINTING WHEN THE USER AUTHENTICATION FUNCTION IS ENABLED

When the user authentication function is enabled in the machine's system settings (administrator), you must enter your user information (login name, password, etc.) in order to print. The information that must be entered varies depending on the authentication method being used, so check with the administrator of the machine before printing.

1

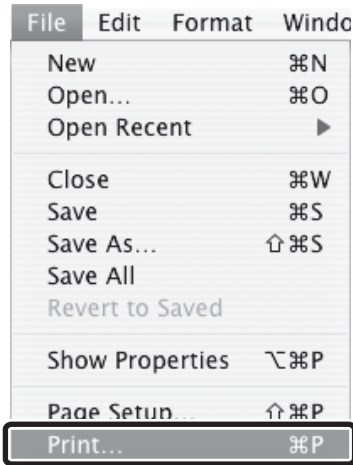

Select [Print] from the application's [File] menu.



The menu used to execute printing may vary depending on the software application.

2

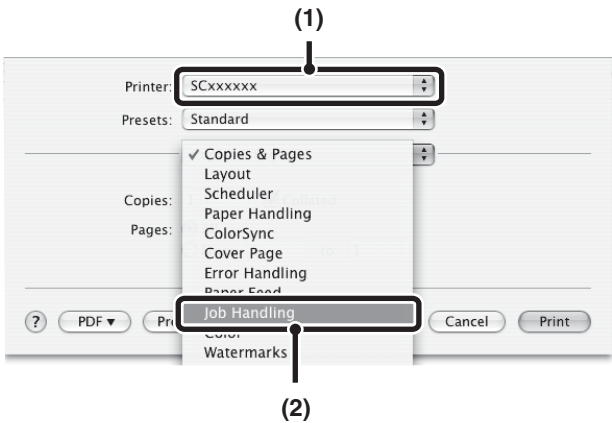

Display the job handling screen.

(1) Make sure that the machine's printer name is selected.

(2) Select [Job Handling].

In Mac OS X v10.5, 10.6, 10.7 and 10.8, select [Job Handling] and then click the [Authentication] tab in the screen that appears.



The machine name that appears in the "Printer" menu is normally [SCxxxxxx]. ("xxxxxx" is a sequence of characters that varies depending on the machine model.)

3



**Start printing.**



**(1) Enter your user information.**

- **When authentication is by login name/password**  
Enter your login name in "Login Name" and your password in "Password" (1 to 32 characters).
- **When authentication is by user number**  
Enter your user number (5 to 8 digits) in "User Number".

**(2) Enter the user name and job name as necessary.**

- **User Name**  
Enter your user name (maximum of 32 characters). Your entered user name will appear at the top of the operation panel. If you do not enter a user name, your computer login name will appear.
- **Job Name**  
Enter a job name (maximum of 30 characters). The entered job name will appear at the top of the operation panel as a file name. If you do not enter a job name, the file name set in the software application will appear.

**(3) Click the [Print] button.**

 You can click the  (lock) button after entering your login name and password, or user number, to simplify operation the next time you wish to print based on the same user authentication.

 When user authentication is enabled in the system settings (administrator), printing is possible without entering user information if black and white printing is set in the printer driver. For black and white print settings, see "[BLACK AND WHITE PRINTING](#)" (page 3-25). The number of pages printed is added to the "Other User" count. In this case, other print functions may be restricted. For more information, ask your administrator.

 **System Settings (Administrator): Disabling of Printing by Invalid User**  
This is used to prohibit printing of print jobs by users whose user information is not stored in the machine. When this function is enabled, printing is not allowed when user information is not entered or incorrect information is entered.



# FREQUENTLY USED FUNCTIONS

This section explains frequently used functions.

- [SELECTING THE COLOUR MODE](#)
- [TWO-SIDED PRINTING](#) (page 3-27)
- [FITTING THE PRINT IMAGE TO THE PAPER](#) (page 3-29)
- [PRINTING MULTIPLE PAGES ON ONE PAGE](#) (page 3-30)
- [STAPLING OUTPUT/PUNCHING HOLES IN OUTPUT](#) (page 3-33)

The explanations assume that the paper size and other basic settings have already been selected. For the basic procedure for printing and the steps for opening the printer driver properties window, see the following section:

- ☞ Windows: [BASIC PRINTING PROCEDURE](#) (page 3-4)
- ☞ Macintosh: [BASIC PRINTING PROCEDURE](#) (page 3-17)

 In Windows, view printer driver Help for details on printer driver settings for each printing function.

## SELECTING THE COLOUR MODE

This section explains how to select the colour mode in the printer driver properties window. The following three selections are available for the colour mode:

- Automatic:** The machine automatically determines whether each page is colour or black and white and prints the page accordingly. Pages with colours other than black and white are printed using Y (Yellow), M (Magenta), C (Cyan) and Bk (Black) toner. Pages that are only black and white are printed using Bk (Black) toner only. This is convenient when printing a document that has both colour and black and white pages, however, the printing speed is slower.
- Color:** All pages are printed in colour. Both colour data and black and white data are printed using Y (Yellow), M (Magenta), C (Cyan) and Bk (Black) toner.
- Black and White:** All pages are printed in black and white. Colour data such as images or materials for a presentation are printed using black toner only. This mode helps conserve colour toner when you do not need to print in colour, such as when proofreading or checking the layout of a document.

 **When "Color Mode" is set to [Automatic]**  
 Even if the print result is black and white, the following types of print jobs will be counted as 4-colour (Y (Yellow), M (Magenta), C (Cyan), and Bk (Black)) print jobs. To be always counted as a black and white job, select [Black and White].

- When the data is created as colour data.
- When the application treats the data as colour data even though the data is black and white.
- When an image is hidden under a black and white image.

### Windows

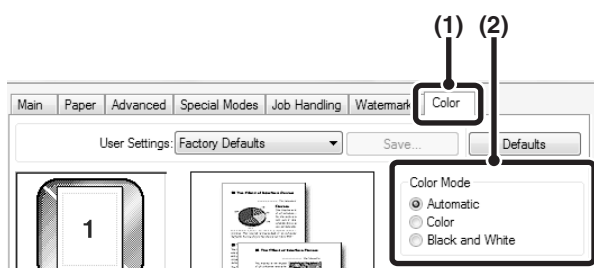

- (1) Click the [Color] tab.
- (2) Select the "Color Mode" that you wish to use.

## BLACK AND WHITE PRINTING

[Black and White] can be selected on the [Main] tab as well as on the [Color] tab. Click the [Black and White Print] checkbox on the [Main] tab so that a checkmark  appears.

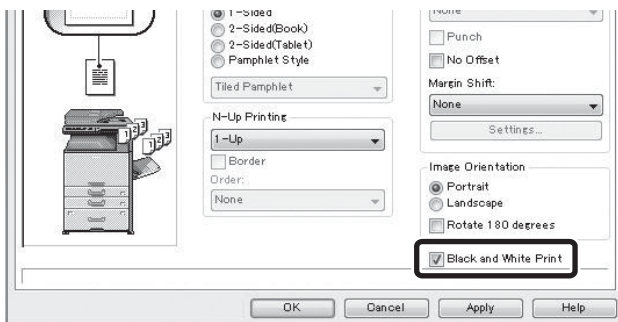

The [Black and White Print] checkbox on the [Main] tab and the "Color Mode" setting on the [Color] tab are linked. When the [Black and White Print] checkbox is selected  on the [Main] tab, [Black and White] is also selected on the [Color] tab.

### Macintosh

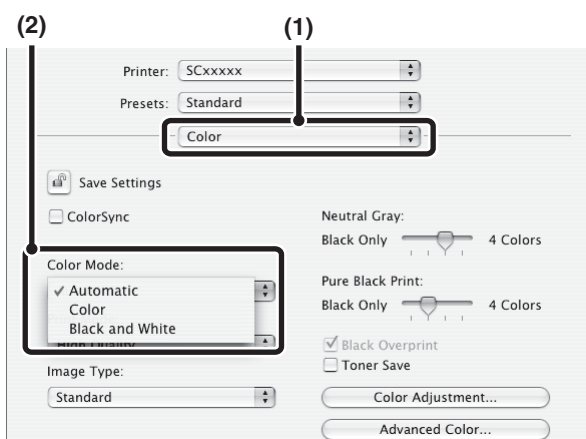

- (1) Select [Color].
- (2) Select the "Color Mode" that you wish to use.

# SELECTING A PRINT MODE SETTING

This section explains the procedure for selecting a print mode setting. The "Print Mode Settings" consist of the following two items:

Normal: This mode is suitable for printing data such as regular text or a table.

High Quality: The print quality of colour photos and text is high.

## Windows

(This function can be used when the PCL6 or PS printer driver is used.)

- (1) Click the [Advanced] tab.
- (2) Select the "Print Mode".

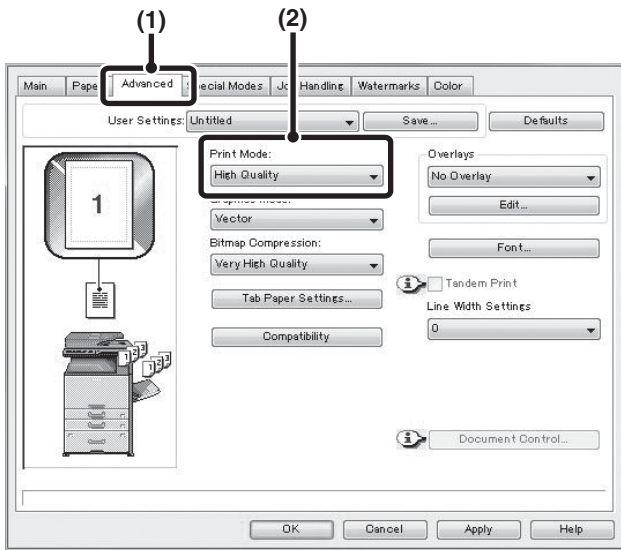



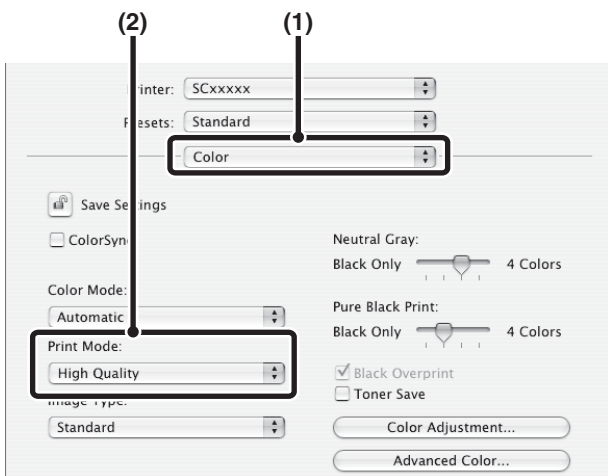

## Macintosh

- (1) Select [Color].
- (2) Select the "Print Mode".

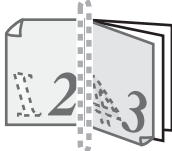

# TWO-SIDED PRINTING

The machine can print on both sides of the paper. This function is useful for many purposes, and is particularly convenient when you want to create a simple pamphlet. Two-sided printing also helps conserve paper.

Paper orientation	Print results			
	Windows	Macintosh	Windows	Macintosh
Vertical	2-Sided(Book)	Long-edged binding (Flip on long edge)	2-Sided(Tablet)	Short-edged binding (Flip on short edge)
				
Horizontal	2-Sided(Book)	Short-edged binding (Flip on short edge)	2-Sided(Tablet)	Long-edged binding (Flip on long edge)
				
The pages are printed so that they can be bound at the side.			The pages are printed so that they can be bound at the top.	

## Windows

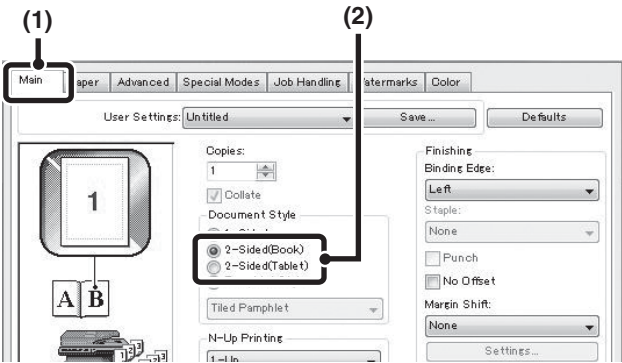

- (1) Configure the settings on the [Main] tab.
- (2) Select [2-Sided(Book)] or [2-Sided(Tablet)].

## Macintosh

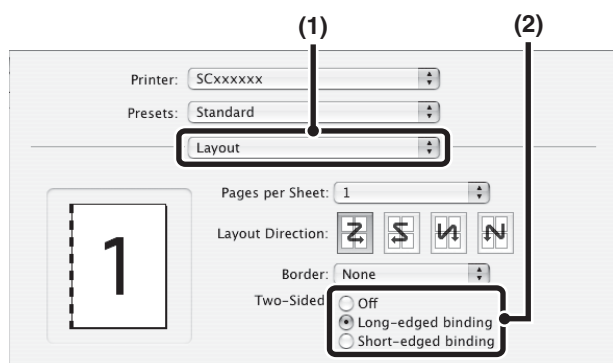

- (1) Select [Layout].
- (2) Select [Long-edged binding] or [Short-edged binding].

# FITTING THE PRINT IMAGE TO THE PAPER

This function is used to automatically enlarge or reduce the printed image to match the size of the paper loaded in the machine.

This is convenient for such purposes as enlarging an A4 or letter size document to A3 or ledger size to make it easier to view, and to print when the same size of paper as the document image is not loaded in the machine.

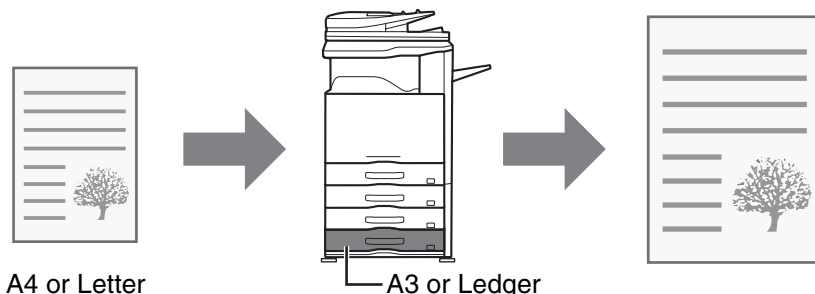

The following example explains how to print an A4 size document on A3 size paper.

## Windows

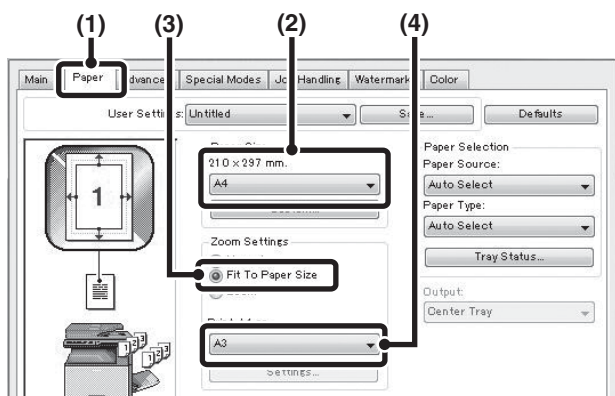

- (1) Click the [Paper] tab.
- (2) Select the size of the print image (for example: A4).
- (3) Select [Fit To Paper Size].
- (4) Select the actual paper size to be used for printing (for example: A3).

## Macintosh

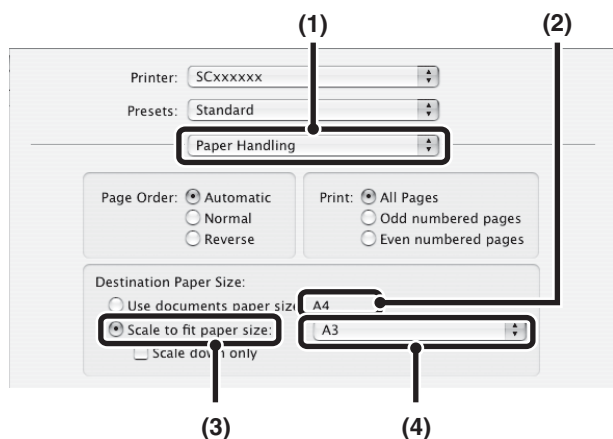

- (1) Select [Paper Handling].
- (2) Check the size of the print image (for example: A4).  
To change the print image size, use the "Paper Size" menu that appears when [Page Setup] is selected.
- (3) Select [Scale to fit paper size].
- (4) Select the actual paper size to be used for printing (for example: A3).

# PRINTING MULTIPLE PAGES ON ONE PAGE





This function can be used to reduce the print image and print multiple pages on a single sheet of paper.

This is convenient when you want to print multiple images such as photos on a single sheet of paper, and when you want to conserve paper. This function can also be used in combination with two-sided printing for maximum conservation of paper.

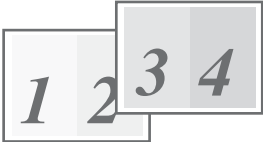
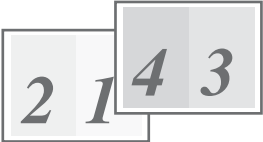
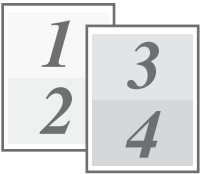
Using the PCL6 printer driver, you can print only the first page in the original size and print multiple reduced pages on the subsequent sheets.

For example, when [2-Up] (2 pages per sheet) and [4-Up] (4 pages per sheet) are selected, the following print results will be obtained, depending on the order selected.

N-Up (Pages per sheet)	Print results		
	Left To Right	Right To Left	Top To Bottom (When the print orientation is landscape)
2-Up (2 pages per sheet)			

N-Up (Pages per sheet)	Right, and Down	Down, and Right	Left, and Down	Down, and Left
4-Up (4 pages per sheet)				



- The page orders for 6-Up, 8-Up, 9-Up, and 16-Up are the same as for 4-Up.
- In a Windows environment, the page order can be viewed in the print image in the printer driver properties window. In a Macintosh environment, the page orders are displayed as selections.
- In a Macintosh environment, the number of pages that can be printed on a single sheet is 2, 4, 6, 9, or 16.

# Windows

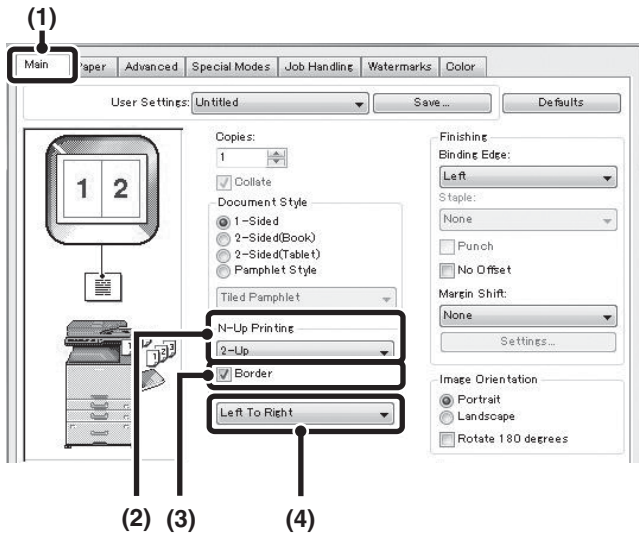

- (1) Configure the settings on the [Main] tab.
- (2) Select the number of pages per sheet.
- (3) If you wish to print borderlines, click the [Border] checkbox so that a checkmark  appears.
- (4) Select the order of the pages.

## Normal printing only on the first page (PCL6 only)

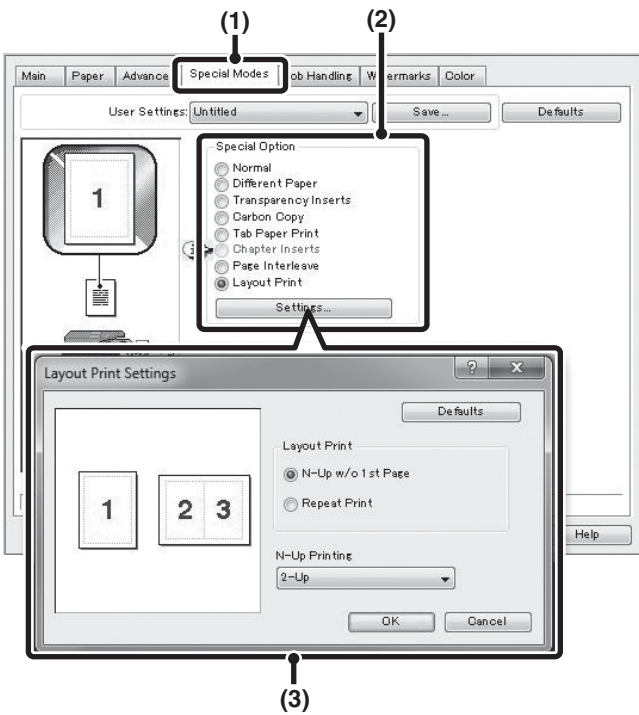

- (1) Click the [Special Modes] tab.
- (2) Select [Layout Print] and click the [Settings] button.
- (3) Select the number of pages for the first sheet and other sheets.  
If you wish to print only the first page in the original size, select [N-Up w/o 1st Page]. For the setting of other sheets, select the number of sheets in "N-Up Printing".



Macintosh

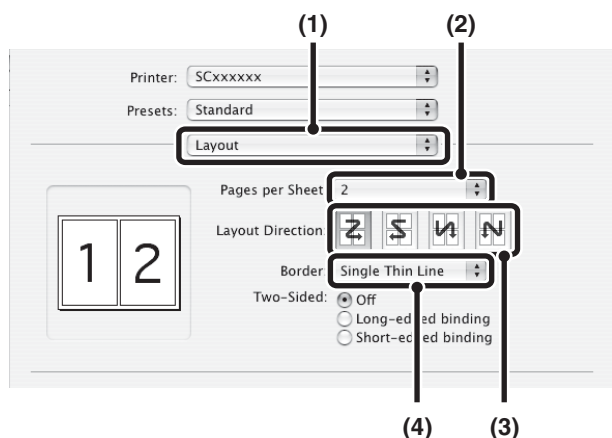

- (1) Select [Layout].
- (2) Select the number of pages per sheet.
- (3) Select the order of the pages.
- (4) If you wish to print borderlines, select the desired type of borderline.

# STAPLING OUTPUT/PUNCHING HOLES IN OUTPUT

## Staple function

The staple function can be used to staple output.

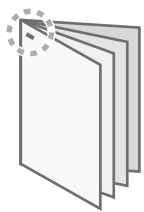
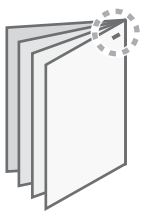
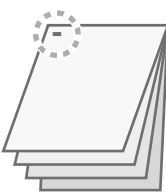
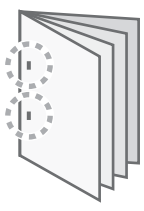
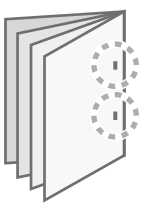
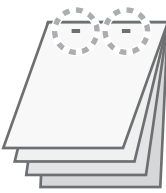

This function saves considerable time when preparing handouts for a meeting or other stapled materials. The staple function can also be used in combination with two-sided printing to create materials with a more sophisticated appearance. Stapling positions and the number of staples can be selected to obtain the following stapling results.

Staples	Left	Right	Top
1 Staple*			
2 Staples			

\* The staple orientation varies depending on the size and orientation of the paper.

## Punch function

The punch function can be selected to punch holes in printed output. Punch hole positions can be set by selecting the binding edge.

Left	Right	Top
		

- To use the staple function, a finisher is required.
- To use the punch function, a punch module must be installed on the finisher.
- The number of holes that can be punched and the spacing between the holes varies depending on the installed punch module.
- For the maximum number of sheets that can be stapled, see "SPECIFICATIONS" in the Start Guide. The maximum number of sheets that can be stapled at once includes any covers and/or inserts that are inserted.
- The staple function cannot be used in combination with the offset function, which offsets the position of each output job from the previous job.
- When the finisher is disabled in the machine's system settings (administrator), the staple function and punch function cannot be used.
- When the staple function or the punch function is disabled in the machine's system settings (administrator), stapling or punching is not possible.

## Windows

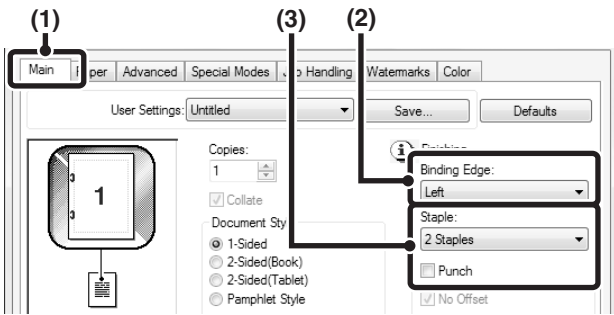

(1) Configure the settings on the [Main] tab.

(2) Select the "Binding Edge".

(3) Select the staple function or the punch function.

- For the staple function, select the number of staples in the "Staple" menu.
- For the punch function, click the [Punch] checkbox so that a checkmark  appears.

## Macintosh

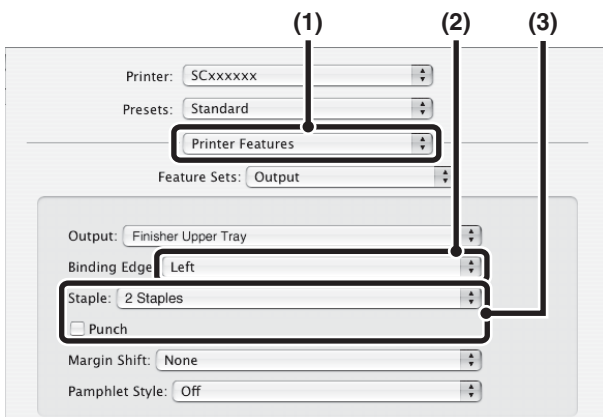

(1) Select [Printer Features].

(2) Select the "Binding Edge".

(3) Select the staple function or the punch function.

- For the staple function, select the number of staples in the "Staple" menu.
- For the punch function, click the [Punch] checkbox so that a checkmark  appears.

# CONVENIENT PRINTING FUNCTIONS

This section explains convenient functions for specific printing objectives.

- [CONVENIENT FUNCTIONS FOR CREATING PAMPHLETS AND POSTERS](#)
- [FUNCTIONS TO ADJUST THE SIZE AND ORIENTATION OF THE IMAGE](#) (page 3-39)
- [COLOUR MODE ADJUSTMENT FUNCTION](#) (page 3-43)
- [FUNCTIONS THAT COMBINE TEXT AND IMAGES](#) (page 3-47)
- [PRINT FUNCTIONS FOR SPECIAL PURPOSES](#) (page 3-50)
- [CONVENIENT PRINTER FUNCTIONS](#) (page 3-58)

The explanations assume that the paper size and other basic settings have already been selected. For the basic procedure for printing and the steps for opening the printer driver properties window, see the following section:

- ☞ Windows: [BASIC PRINTING PROCEDURE](#) (page 3-4)
- ☞ Macintosh: [BASIC PRINTING PROCEDURE](#) (page 3-17)

 In Windows, view printer driver Help for details on printer driver settings for each printing function.

## CONVENIENT FUNCTIONS FOR CREATING PAMPHLETS AND POSTERS

### CREATING A PAMPHLET (Pamphlet)

The pamphlet function prints on the front and back of each sheet of paper so that the sheets can be folded and bound to create a pamphlet. This is convenient when you wish to compile printed output into a pamphlet.

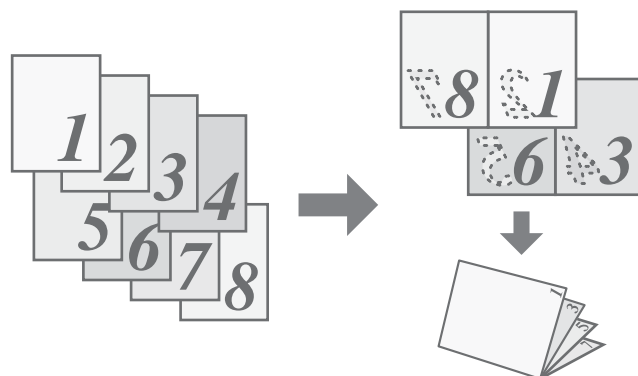

#### Windows

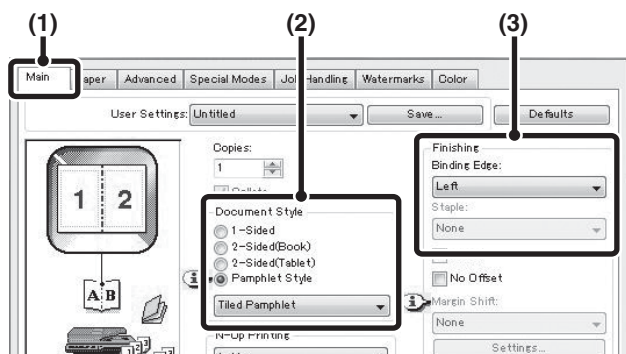

- (1) Configure the settings on the [Main] tab.
- (2) Select [Pamphlet Style]
- (3) Select the "Binding Edge".

## Macintosh

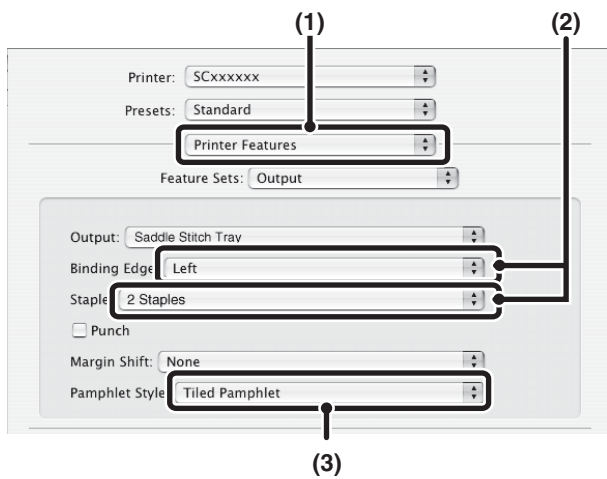

- (1) Select [Printer Features].
- (2) Select the "Binding Edge".
- (3) Select [Tiled Pamphlet] or [2-Up Pamphlet].

# INCREASING THE MARGIN (Margin Shift)

This function is used to shift the print image to increase the margin at the left, right, or top of the paper. This is convenient when you wish to staple or punch the output but the binding area overlaps the text. When a finisher is installed, the staple function or the punch function can be used with this function.

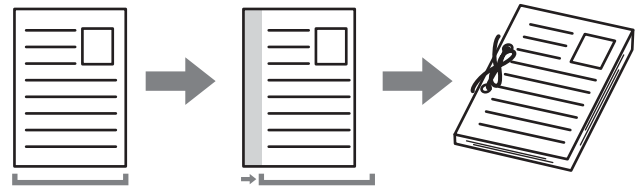

## Windows

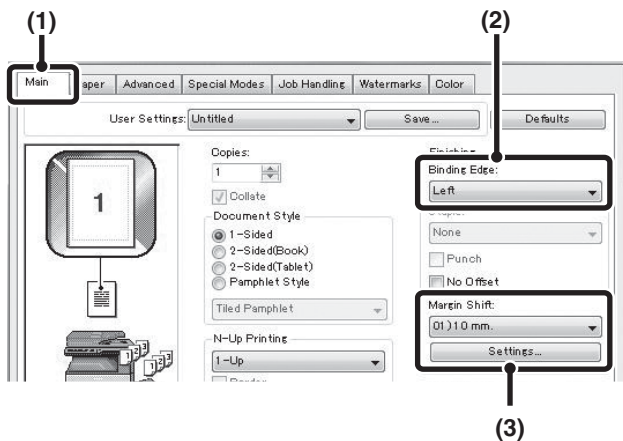

- (1) Configure the settings on the [Main] tab.
- (2) Select the "Binding Edge".
- (3) Select the "Margin Shift".

Select from the "Margin Shift" menu. If you wish to configure another numeric setting, select the setting from the pull-down menu and click the [Settings] button. Click the button or directly enter the number.

## Macintosh

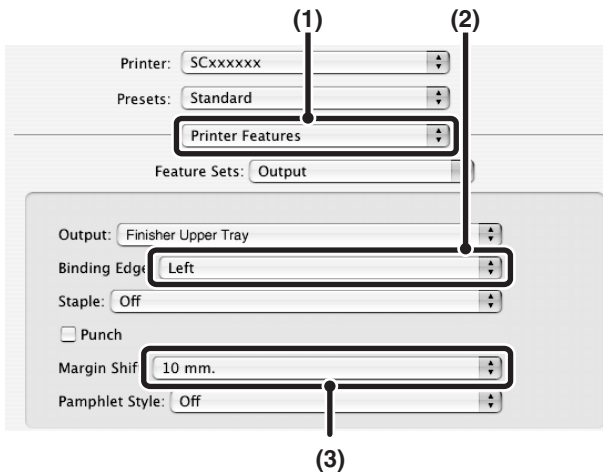

- (1) Select [Printer Features].
- (2) Select the "Binding Edge".
- (3) Select the "Margin Shift".

# CREATING A LARGE POSTER (Poster Printing)

(This function is only available in Windows.)

One page of print data can be enlarged and printed using multiple sheets of paper (4 sheets (2 x 2), 9 sheets (3 x 3) or 16 sheets (4 x 4)). The sheets can then be attached together to create a large poster. To enable precise alignment of the edges of the sheets during attachment, borderlines can be printed and overlapping edges can be created (overlap function).

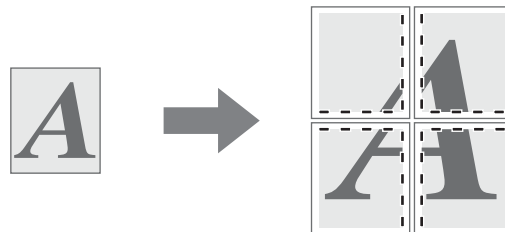

## Windows

(This function can be used when the PCL6 or PS printer driver is used.)

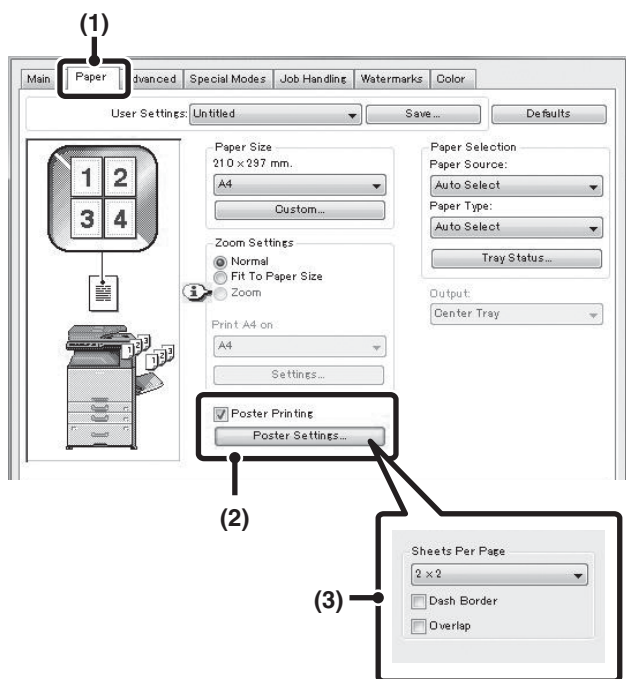

- (1) Click the [Paper] tab.
- (2) Select the [Poster Printing] checkbox  and click the [Poster Settings] button.
- (3) Select poster settings.  
Select the number of sheets of paper to be used from the pull-down menu. If you wish to print borderlines and/or use the overlap function, select the corresponding checkboxes .

# FUNCTIONS TO ADJUST THE SIZE AND ORIENTATION OF THE IMAGE

## ROTATING THE PRINT IMAGE 180 DEGREES (Rotate 180 degrees)

This feature rotates the image 180 degrees so that it can be printed correctly on paper that can only be loaded in one orientation (such as envelopes or paper with punch holes). (In Mac OS X, a portrait image cannot be rotated 180 degrees.)

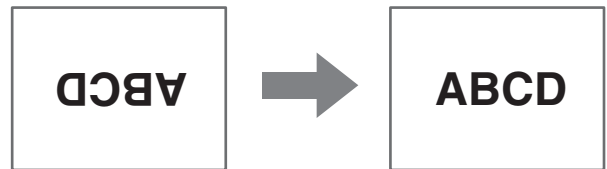

### Windows

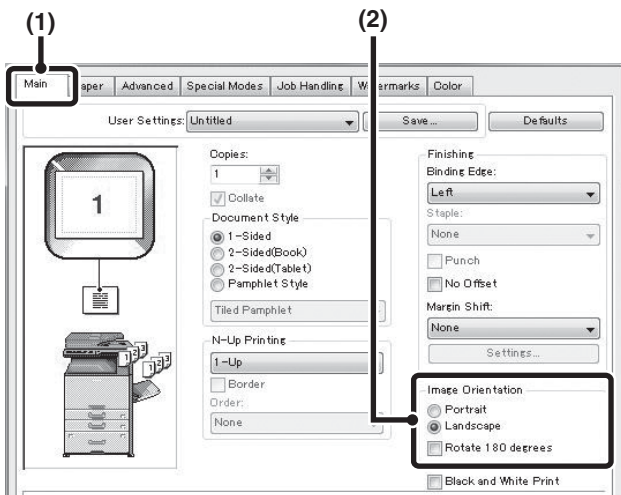

- (1) Select the setting on the [Main] tab.
- (2) Select the [Rotate 180 degrees] checkbox .

### Macintosh

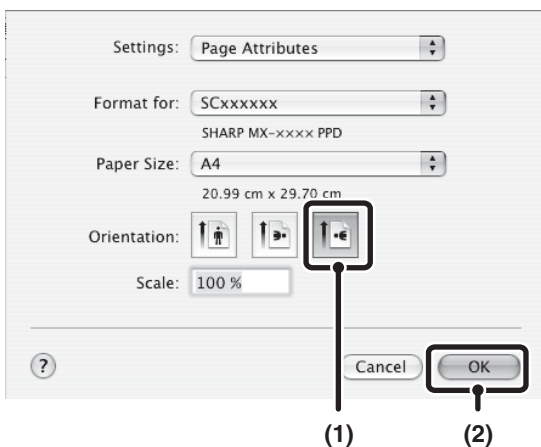

- (1) Select [Page Setup] from the [File] menu and click the  button.
- (2) Click the [OK] button.



# ENLARGING/REDUCING THE PRINT IMAGE (Zoom/XY-Zoom)

This function is used to enlarge or reduce the image to a selected percentage. This allows you to enlarge a small image or add margins to the paper by slightly reducing an image.

When using the PS printer driver (Windows), you can set the width and length percentages separately to change the proportions of the image. (XY-Zoom)

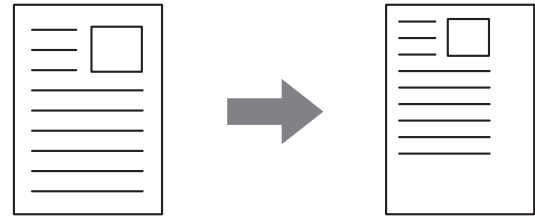

## Windows

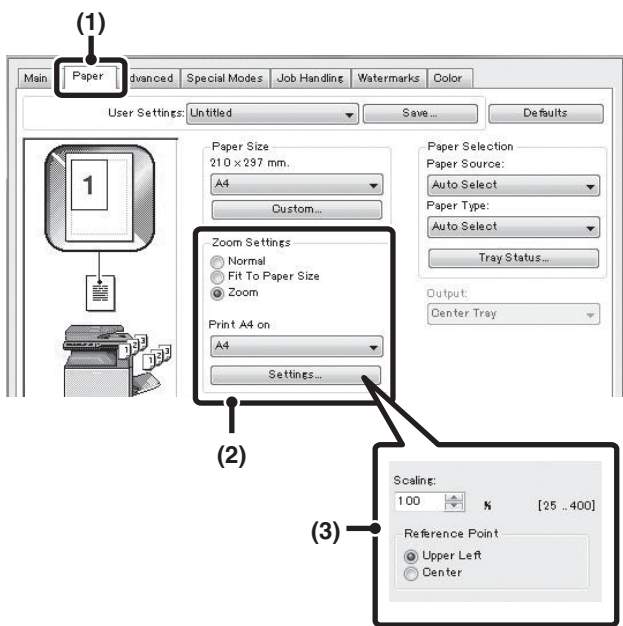

- (1) Click the [Paper] tab.
- (2) Select [Zoom] and click the [Settings] button.

The actual paper size to be used for printing can be selected from the pull-down menu.

- (3) Select the zoom ratio.

Directly enter a number (%) or click the button to change the ratio in increments of 1%. You can also select [Upper Left] or [Center] for the base point on the paper.

\* This function can be used when the PCL6 or PS printer driver is used.

## Macintosh

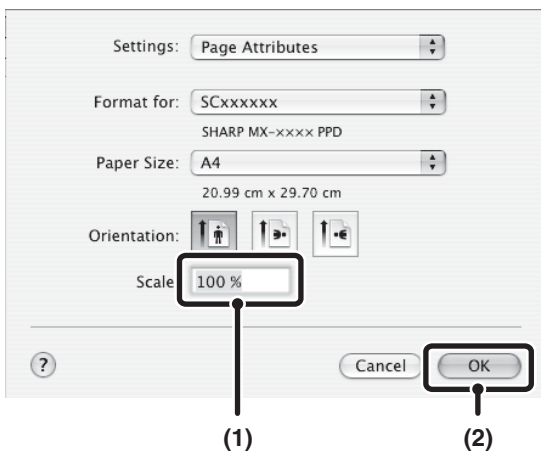

- (1) Select [Page Setup] from the [File] menu and enter the ratio (%).
- (2) Click the [OK] button.

# ADJUSTING LINE WIDTHS WHEN PRINTING (Line Width Settings)

(This function is only available in Windows.)

When lines in special applications such as CAD cannot be printed correctly, this setting can be used to adjust line widths, such as making overall line widths wider. (This setting is only effective for vector data; raster data such as bitmap images cannot be adjusted.) When the data includes lines of varying widths, you can also print all lines at the minimum width. (Only for black and white printing.)

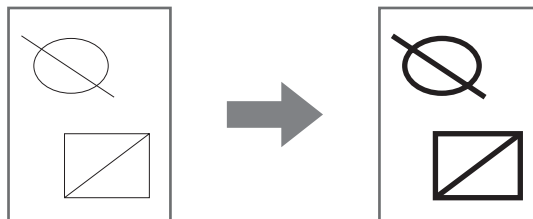

## Windows

(This function can be used when the PCL6 and Sharp Advanced Printing Language-c printer driver is used.)

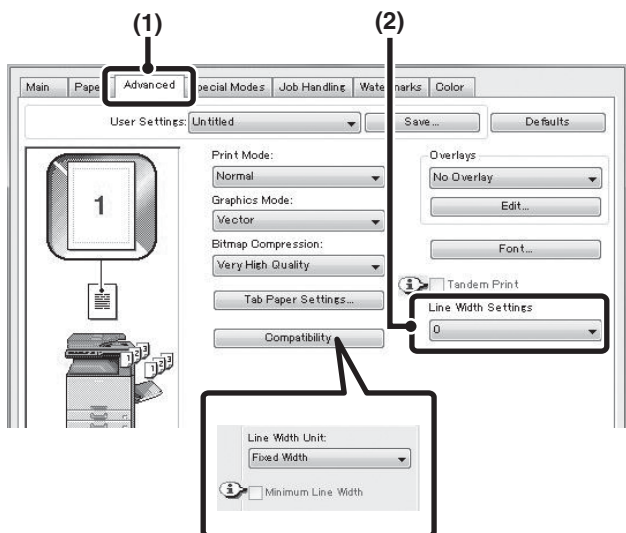

**(1) Click the [Advanced] tab.**

**(2) Adjust the line width.**

Select a number from the pull-down menu.



- The units of line-width adjustment can be set to "Fixed Width" or "Ratio". Click the [Compatibility] button and select the units from the "Line Width Unit" menu.
- To print all lines in the data at the minimum line width, click the [Compatibility] button and select the [Minimum Line Width] checkbox (☑).

# REVERSING THE IMAGE (Mirror Image)

(This function is only available in Windows.)

The image can be reversed to create a mirror image. This function can be used to conveniently print a design for a woodblock print or other printing medium.

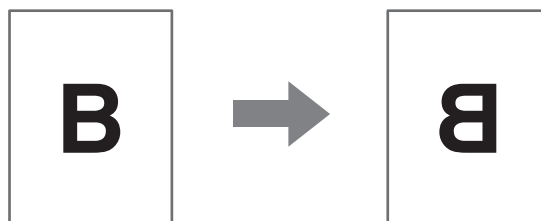

## Windows

(This function can be used when the PS printer driver is used.)

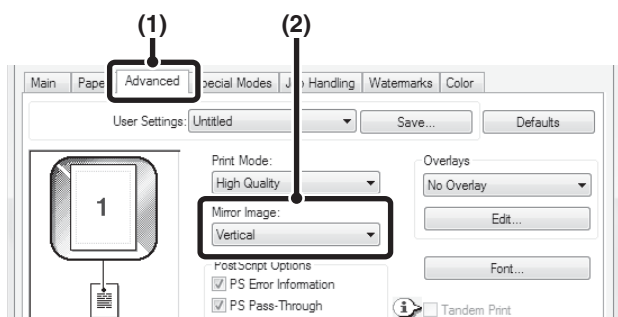

(1) Click the [Advanced] tab.

(2) Select a mirror image setting.

If you wish to reverse the image horizontally, select [Horizontal]. If you wish to reverse the image vertically, select [Vertical].

# COLOUR MODE ADJUSTMENT FUNCTION

## ADJUSTING THE BRIGHTNESS AND CONTRAST OF THE IMAGE (Colour Adjustment)

The brightness and contrast can be adjusted in the print settings when printing a photo or other image. These settings can be used for simple corrections when you do not have image editing software installed on your computer.

### Windows

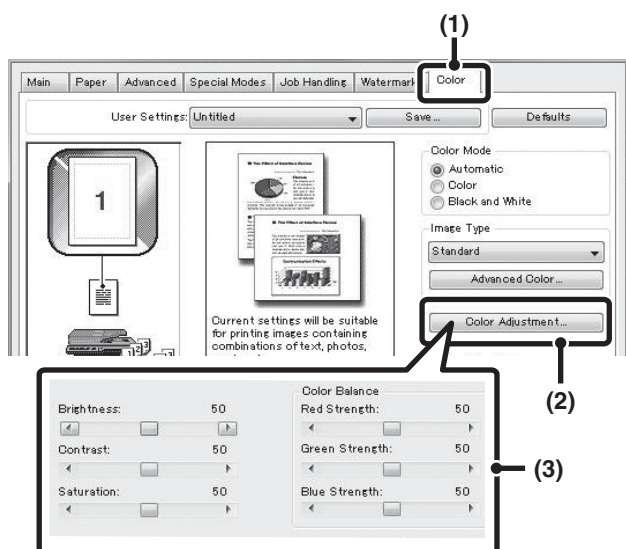

- (1) Click the [Color] tab.
- (2) Click the [Color Adjustment] button.
- (3) Adjust the colour settings.

To adjust a setting, drag the slide bar  or click the  or  button.

### Macintosh

(This function can only be used in Mac OS X v10.4.11.)

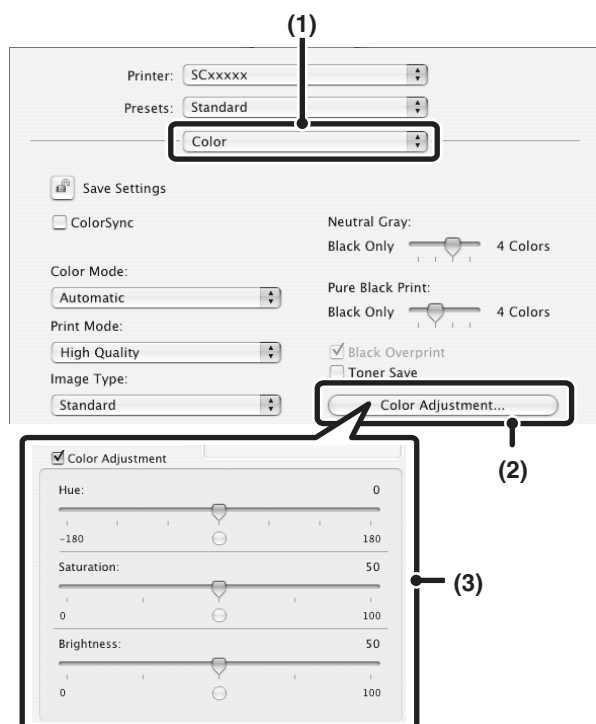

- (1) Select [Color].
- (2) Click the [Color Adjustment] button.
- (3) Select the [Color Adjustment] checkbox  and adjust the colour.

Adjust the settings by dragging the slide bars .

# PRINTING FAINT TEXT AND LINES IN BLACK (Text To Black/Vector To Black)

(This function is only available in Windows.)

When printing a colour image in greyscale, colour text and lines that are faint can be printed in black. (Raster data such as bitmap images cannot be adjusted.) This allows you to bring out colour text and lines that are faint and difficult to see when printed in greyscale.

- [Text To Black] can be selected to print all text other than white text in black.
- [Vector To Black] can be selected to print all vector graphics other than white lines and areas in black.

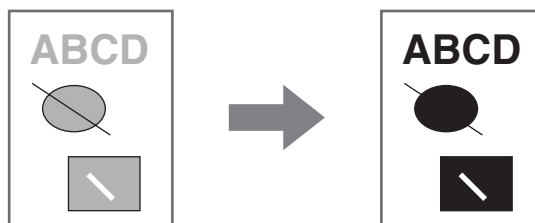

## Windows

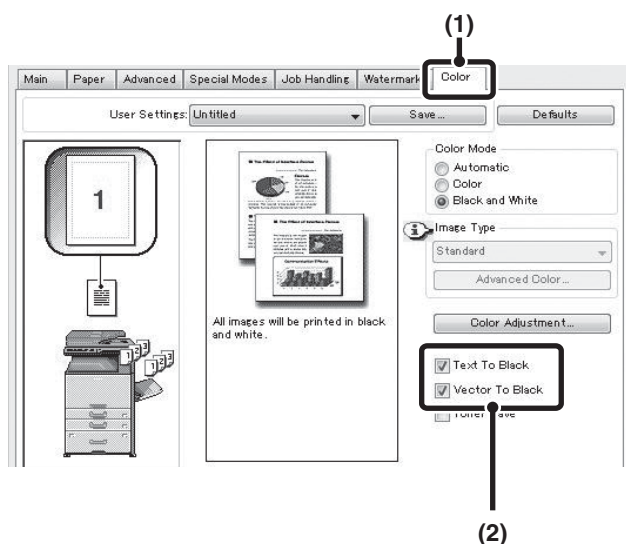

- (1) Click the [Color] tab.
- (2) Select the [Text To Black] checkbox  and/or the [Vector To Black] checkbox .

# SELECTING COLOUR SETTINGS TO MATCH THE IMAGE TYPE (Advanced Colour)

Preset colour settings are available in the machine's printer driver for various uses. These enable printing using the most suitable colour settings for the colour image type.

Advanced colour settings can also be configured to match the objective of the colour image, such as colour management settings and the screening setting for adjustment of colour tone expression.

## Windows

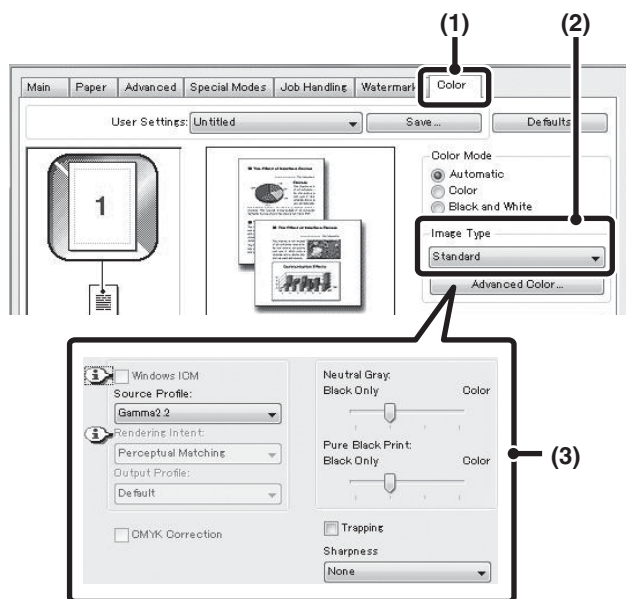

(1) Click the [Color] tab.

(2) Select the "Image Type".

A document type to match the data to be printed can be selected from the pull-down menu.

- Standard (for data that includes text, photos, graphs, etc.)
- Graphics (for data with many drawings or illustrations)
- Photo (for photo data or data that uses photos)
- CAD (for engineering drawing data)
- Scan (for data scanned by a scanner)
- Colorimetric (Data which needs to be printed in almost the same colours as those on the screen)
- Custom (for data to be printed with special settings)

(3) Select advanced colour settings.

If you wish to select advanced settings, click the [Advanced Color] button.

If you wish to perform colour management using Windows ICM\* in your operating system, select [Custom] for the image type at step (2) and then select the [Windows ICM] checkbox . To configure advanced colour management settings such as "Source Profile", select the desired settings from the menus.

\*Cannot be selected when using the PS printer driver on Windows Vista/Server 2008/7/Server 2012/8.

Macintosh

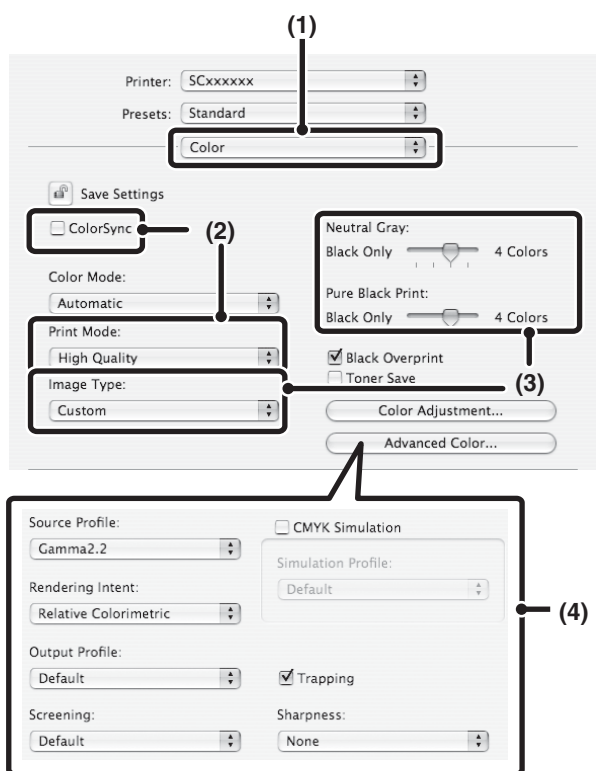

(1) Select [Color].

(2) Select colour print settings.

To use the Mac OS Color Management function, select the [ColorSync] checkbox . When this is done, "Image Type" cannot be selected.

(3) Select the colour image type.

An image type to match the data to be printed can be selected from the pull-down menu.

- Standard (for data that includes text, photos, graphs, etc.)
  - Graphics (for data with many drawings or illustrations)
  - Photo (for photo data or data that uses photos)
  - CAD (for engineering drawing data)
  - Scan (for data scanned by a scanner)
  - Colorimetric (Data which needs to be printed in almost the same colours as those on the screen)
  - Custom (for data to be printed with special settings)
- [Neutral Gray] can be used when [Custom] is selected.

(4) Select advanced colour settings.

If you wish to select detailed settings, click the [Advanced Color] button.

To configure colour management settings, select the desired settings from the menus. To use "CMYK Simulation", select the [CMYK Simulation] checkbox  and then select the desired setting.

 In Mac OS X v10.5, 10.6, 10.7 and 10.8, click the [Advanced] tab to configure advanced colour settings.

The following colour management settings are available.

(There may be certain settings that cannot be configured depending on your OS and type of printer driver.)

- Windows ICM checkbox: Colour management method in a Windows environment
- ColorSync checkbox: Colour management method in a Macintosh environment
- Source Profile: Select the colour profile used to display the image on the computer screen.
- Rendering Intent: Standard value used when converting the colour balance of the image displayed on the computer screen to a colour balance that can be printed by the machine.
- Output Profile: Selecting a colour profile for the image to be printed
- CMYK Correction: When printing a CMYK image, you can correct the image to obtain the optimum result.
- Screening: Select the most suitable image processing method for the image being printed.
- Neutral Gray: Select the toner colour used to print grey areas.
- Pure Black Print: Data in black colour can be printed with a black toner only.
- Trapping: Facilitates the prevention of white splotches on the circumference of the colour.
- Sharpness: It makes the outline of the image clearer and smooth.
- Black Overprint: Prevents whitening of the outline of black text.
- CMYK Simulation: The colour can be adjusted to simulate printing using the process colours used by printing presses.
- Simulation Profile: Selecting a process colour

# FUNCTIONS THAT COMBINE TEXT AND IMAGES

## ADDING A WATERMARK TO PRINTED PAGES (Watermark)

Faint shadow-like text can be added to the background of the printed image as a watermark. The size, colour, density, and angle of the watermark text can be adjusted. The text can be selected from a pre-stored list, or entered to create an original watermark.

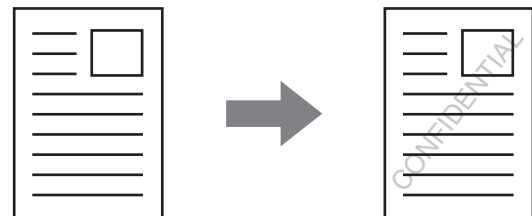

### Windows

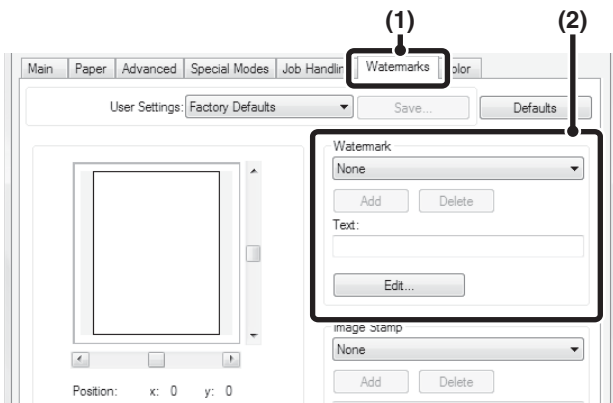

- (1) Click the [Watermarks] tab.
- (2) Select the watermark settings.

Select a stored water mark from the pull-down menu. You can click the [Edit] button to edit the font colour and select other detailed settings.



**If you wish to create a new watermark...**

Enter the text of the watermark in the "Text" box and click the [Add] button.

### Macintosh

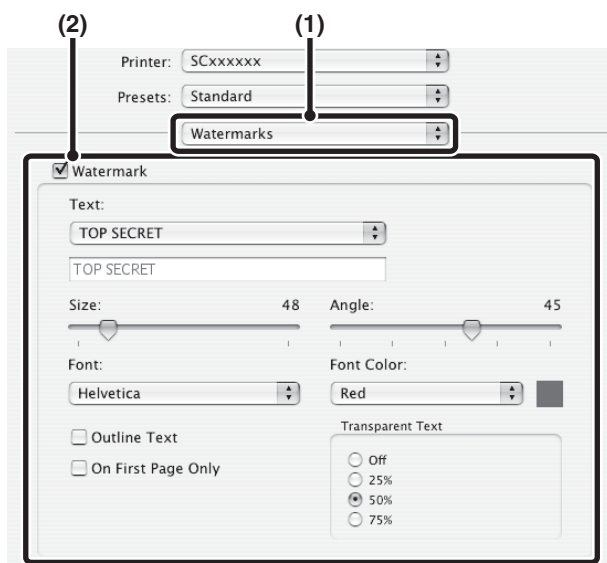

- (1) Select [Watermarks].
- (2) Click the [Watermark] checkbox and configure watermark settings.

Detailed watermark settings can be configured such as selection of the text and editing of the font and colour. Adjust the size and angle of the text by dragging the slide bar.



# PRINTING AN IMAGE OVER THE PRINT DATA (Image Stamp)

(This function is only available in Windows.)

A bitmap or JPEG image stored on your computer can be printed over the print data. The size, position, and angle of the image can be adjusted. This feature can be used to "stamp" the print data with a frequently used image or an icon of your own creation.

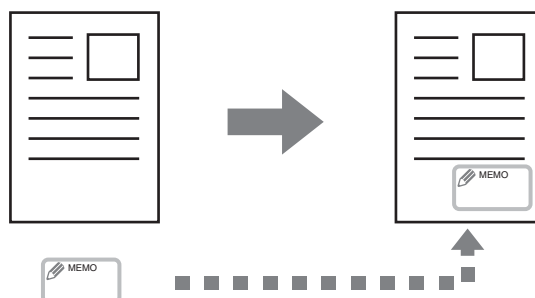

## Windows

(This function can be used when the PCL6 or PS printer driver is used.)

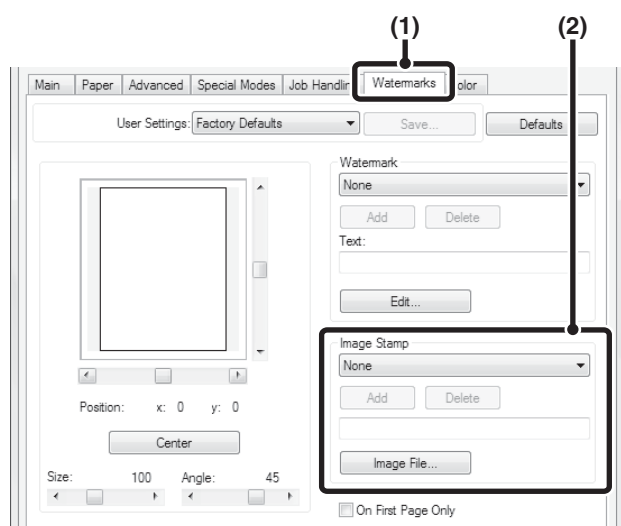

- (1) Click the [Watermarks] tab.
- (2) Select the image stamp setting.

If an image stamp has already been stored, it can be selected from the pull-down menu. If you have not stored an image stamp, click the [Image File], select the file you wish to use for the image stamp, and click the [Add] button.

# CREATING OVERLAYS FOR PRINT DATA (Overlays)

(This function is only available in Windows.)

(On the MX-2314N, the productivity kit is required.)  
 The print data can be printed in a previously created overlay. By creating table rulings or a decorative frame in an application different from that of the text file and registering the data as an overlay file, an attractive print result can be easily obtained without the need for complex manipulations.

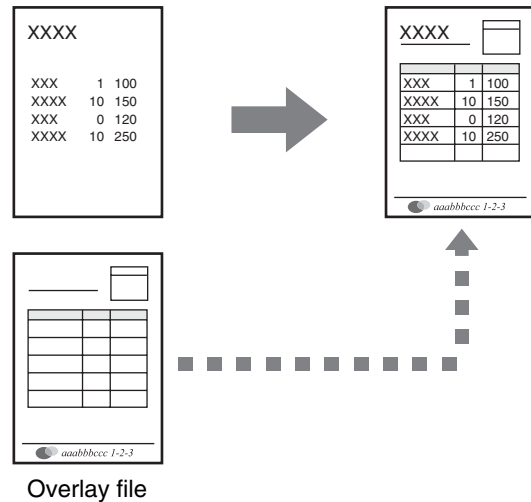

## Windows

(This function can be used when the PCL6 or PS printer driver is used.)

### Create an overlay file.

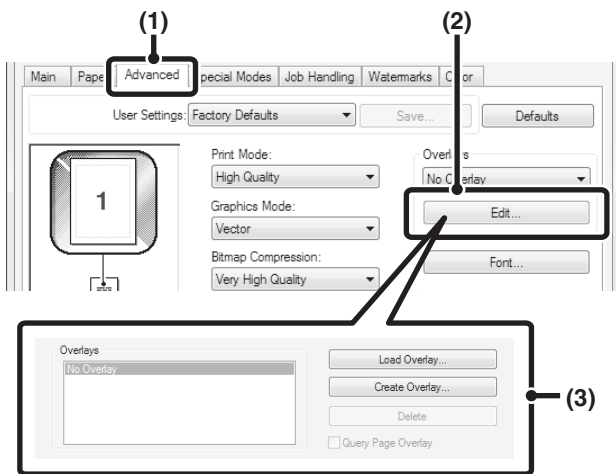

#### (1) Click the [Advanced] tab.

Configure the printer driver settings from the software application that you wish to use to create the overlay file.

#### (2) Click the [Edit] button.

#### (3) Create an overlay file.

Click the [Create Overlay] button and specify the name and folder to be used for the overlay file that you wish to create. The file will be created when the settings are completed and printing is started.



- When printing is started, a confirmation message will appear. The overlay file will not be created until the [Yes] button is clicked.
- To register a previously existing overlay file, click the [Load Overlay] button.

### Printing with an overlay file

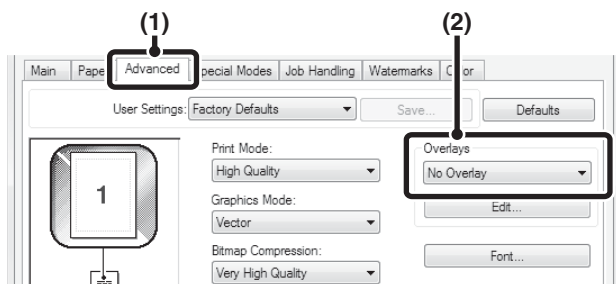

#### (1) Click the [Advanced] tab.

Configure the printer driver settings from the application from which you wish to print using the overlay file.

#### (2) Select the overlay file.

A previously created or stored overlay file can be selected from the pull-down menu.

# PRINT FUNCTIONS FOR SPECIAL PURPOSES

## PRINTING SPECIFIED PAGES ON DIFFERENT PAPER (Different Paper)

**Using this function in a Windows environment**

The front and back cover and specified pages of a document can be printed on paper that is different from the other pages. Use this function when you wish to print the front and back cover on heavy paper, or insert coloured paper or a different paper type at specified pages. You can also insert paper as an insert without printing on it.

**Using this function in a Macintosh environment**

The front cover and last page can be printed using paper that is different from the other pages. This function can be used, for example, when you want to print only the front cover and last page on thick paper.

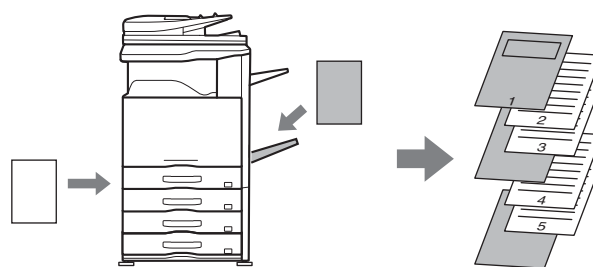

### Windows

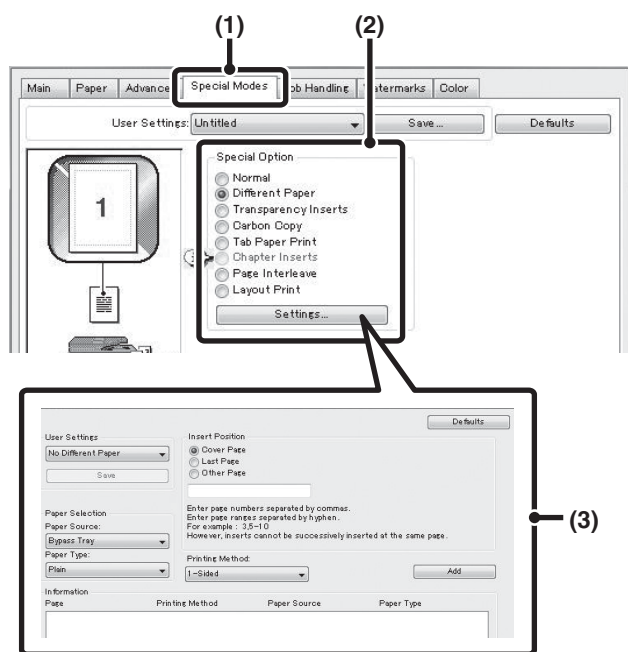

- (1) Click the [Special Modes] tab.
- (2) Select [Different Paper] and click the [Settings] button.
- (3) Select paper insertion settings.

Select the insertion position, paper source, and printing method from the corresponding menus. Click the [Add] button to show the selected settings in "Information". When you have completed the settings, click the [Save] button in "User Settings" to save the settings.

- When [Bypass Tray] is selected in "Paper Source", be sure to select the "Paper Type" and load that type of paper in the bypass tray.
- **About paper insertion settings**  
When [Other Page] is selected for "Insert Position", the insert position can be specified by directly entering a page number. However, inserts cannot be successively inserted at the same page. When "Printing Method" is set to [2-Sided], the specified page and the next page after it will be printed on the front and reverse side of the paper, and thus an insert setting at a page printed on the reverse side will not be effective.

Macintosh

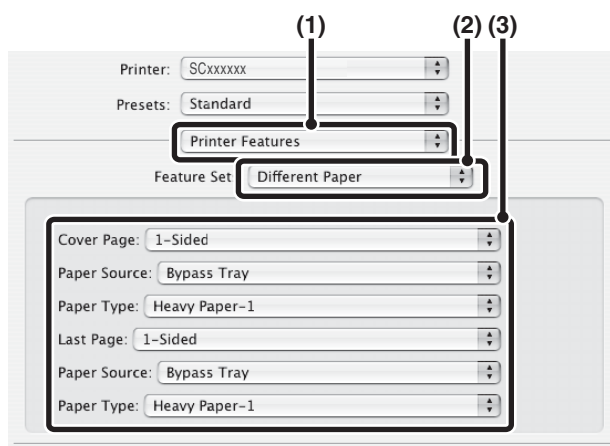

(1) Select [Printer Features].

(2) Select [Different Paper].

(3) Select cover insertion settings.

Select the print setting, paper tray, and paper type for the cover page and last page.

# ADDING INSERTS WHEN PRINTING ON TRANSPARENCY FILM (Transparency Inserts)

When printing on transparency film, this function helps prevent the sheets of transparency film from sticking together by inserting a sheet of paper between each sheet of film. It is also possible to print the same content on each inserted sheet of paper as is printed on the corresponding sheet of transparency film.

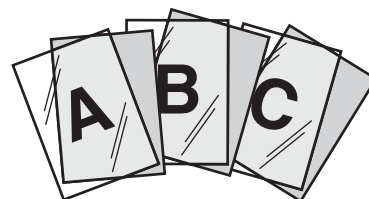

## Windows

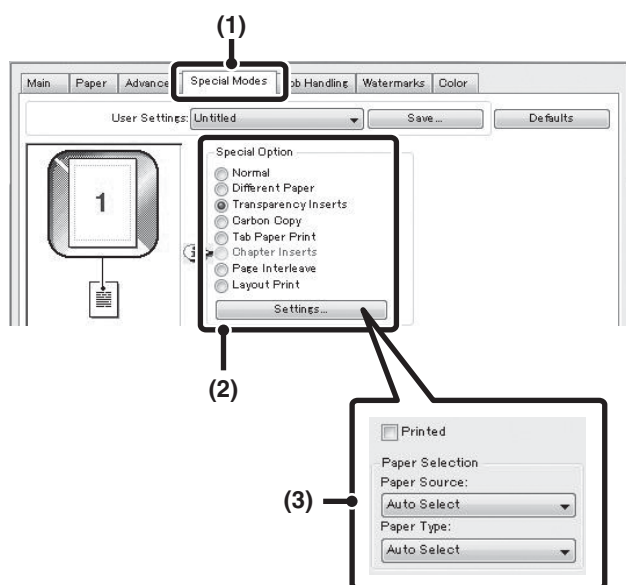

- (1) Click the [Special Modes] tab.
- (2) Select [Transparency Inserts] and click the [Settings] button.
- (3) Select transparency insert settings.

To print the same content on the insert as is printed on the sheet of transparency film, select the [Printed] checkbox . Select the paper source and type if needed.

Set [Transparency] for the "Paper Type" of the bypass tray.

## Macintosh

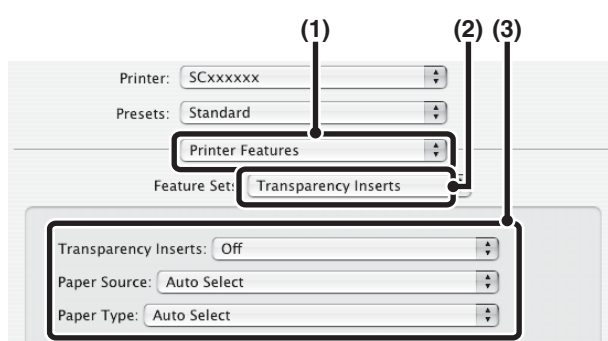

- (1) Select [Printer Features].
- (2) Select [Transparency Inserts].
- (3) Select transparency insert settings.

To print the same content on the insert as is printed on the sheet of transparency film, select [Print] in "Transparency Inserts". Select the paper source and type if needed.

Set [Transparency] for the "Paper Type" of the bypass tray.

# PRINTING A CARBON COPY (Carbon Copy)

(This function is only available in Windows.)

This function is used to print an additional copy of the print image on paper that is the same size but from a different paper tray.

For example, if carbon copy print is selected when standard paper is loaded in tray 1 and coloured paper is loaded in tray 2, a print result similar to a carbon copy slip can be obtained with a single selection of the print command. As another example, if standard paper is loaded in tray 1 and recycled paper is loaded in tray 2, Carbon Copy can simultaneously print one copy for presentation and one copy as a duplicate.

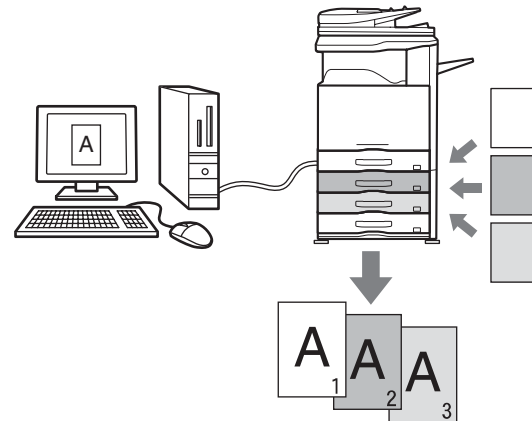

## Windows

(This function can be used when the PCL6 or PS printer driver is used.)

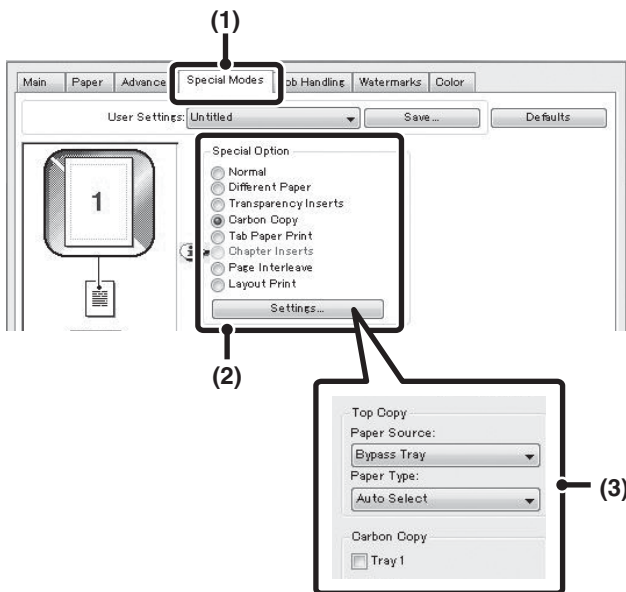

(1) Click the [Special Modes] tab.

(2) Select [Carbon Copy] and click the [Settings] button.

(3) Select the carbon copy settings.

Select the tray for the "Top Copy" and then select the tray for the carbon copy (or copies) in "Carbon Copy".



When the bypass tray is selected, be sure to select the "Paper Type".

# PRINTING TEXT ON TABS OF TAB PAPER (Tab Paper Print/Tab Paper Settings)

(This function is only available in Windows.)

This function is used to print text on the tabs of tab paper.

### Tab Paper Print (PCL6 only)

You can print on each sheet of tab paper that you insert in the desired page position.

Text to be printed on tabs can be entered in [Tab Paper Print] on the [Special Modes] tab of the printer driver properties window, and detailed settings can be configured such as the size of the tabs, the starting position, the distance between tabs, and the page numbers where tab sheets will be inserted.

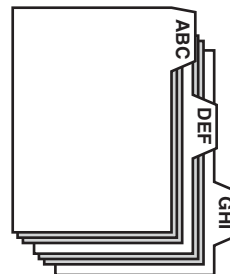

### Tab Paper Settings (PCL6, PS only)

Text to be printed on tab papers can be created in a software application, and then [Tab Paper Settings] on the [Advanced] tab of the printer driver properties window can be used to specify how far the text needs to be shifted for tab printing.

Original image

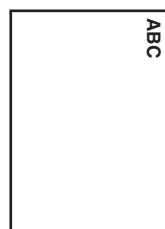

Printed on the tab paper

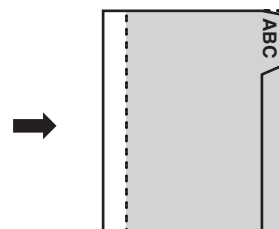

# Windows

## Tab Paper Print (PCL6 only)

Open the data that you wish to print on the tab paper and then select the settings.

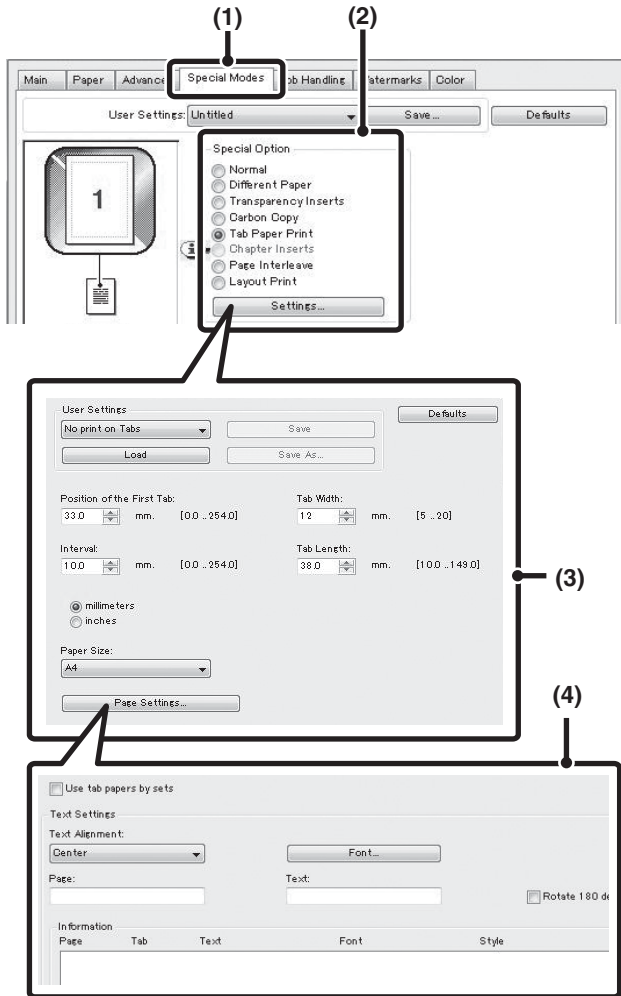

(1) Click the [Special Modes] tab.

(2) Select [Tab Paper Print] and click the [Settings] button.

(3) Select the tab position settings.

For commercially available tab paper, you can use the existing settings in "User Settings" such as [A4-5tab-D]. For other types of tab paper, the position of the first tab, the distance between tabs, and the horizontal and vertical dimensions of the tab can be directly entered or changed using the button. In addition, the size of the tab paper can be selected in "Paper Size".

(4) Select the page settings.

Specify the pages where you wish to insert tab paper and enter the text that you wish to print on the tabs. You can also select the font and adjust the layout.



- Set [Tab Paper] for the "Paper Type" of the bypass tray.
- The tab paper settings can be stored and a stored file opened in "User Settings".



### Tab Paper Settings (PCL6, PS only)

When you have finished preparing the data to be printed on the tabs in the software application, select the following settings:

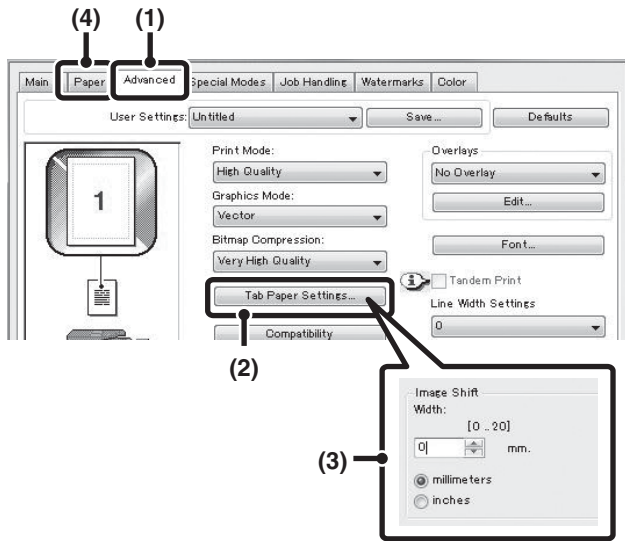

- (1) Click the [Advanced] tab.
- (2) Click the [Tab Paper Settings] button.
- (3) Select the tab paper settings.

To shift the image, directly enter a number or click the button.

- (4) Select the paper source and type.

Click the [Paper] tab, and select [Bypass Tray] for "Paper Source" and [Tab Paper] for "Paper Type".



Set [Tab Paper] for the "Paper Type" of the bypass tray.

# TWO-SIDED PRINTING WITH SPECIFIC PAGES PRINTED ON THE FRONT SIDE (Chapter Inserts)

(This function is only available in Windows.)

You can have specific pages printed on the front side of the paper.

When a page (such as the first page of a chapter) is specified as a front side page, the page will be printed on the front side of the paper even if it would normally be printed on the reverse side (the reverse side will be left blank and the page will be printed on the front side of the next sheet of paper).

Example:

When pages 4 and 8 are specified as page settings.

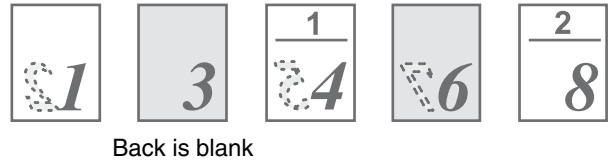

## Windows

(This function can be used when the PCL6 printer driver is used.)

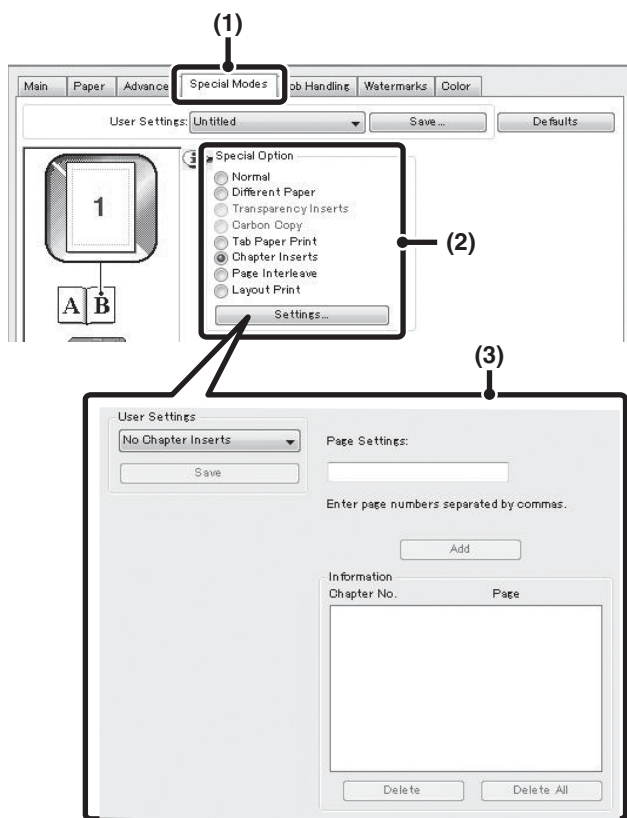

- (1) Click the [Special Modes] tab.
- (2) Select [Chapter Inserts] and click the [Settings] button.
- (3) Select the chapter settings.

Enter the page numbers that are to begin chapters in "Page Settings". Click the [Add] button and your settings will appear in "Information". When you have finished selecting settings, click the [Save] button in "User Settings" to save the settings.

# CONVENIENT PRINTER FUNCTIONS

## USING TWO MACHINES TO PRINT A LARGE PRINT JOB (Tandem Print)

(On the MX-2314N, the productivity kit is required.)  
 Two machines are required to use this function. Tandem Print allows you to divide a large print job between two machines connected to your network. The machines simultaneously print each half of the job, making it possible to shorten the printing time when printing a large number of sets.

To use Tandem Print, the IP address of the slave machine configured in "Tandem Connection Setting" in the machine's system settings (administrator) must be configured in the printer driver. In a Windows environment, this can be accomplished automatically by clicking the [Auto Configuration] button on the [Configuration] tab of the printer driver. In a Macintosh environment, this can be accomplished automatically by clicking the [Tandem Settings] button.

Example: Printing 4 sets of copies

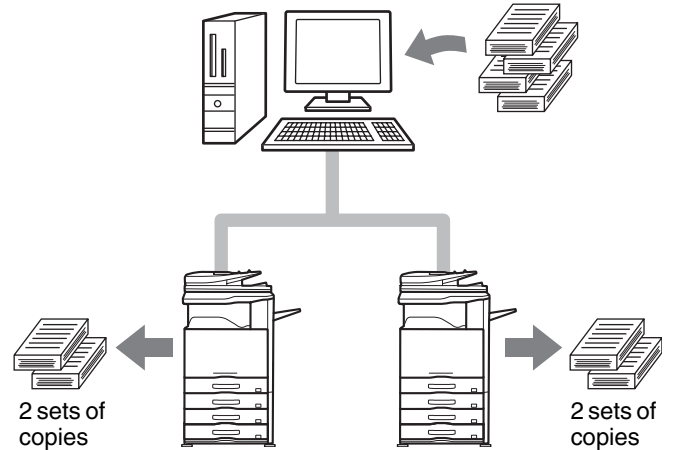

### Windows

(This function can be used when the PCL6 or PS printer driver is used.)

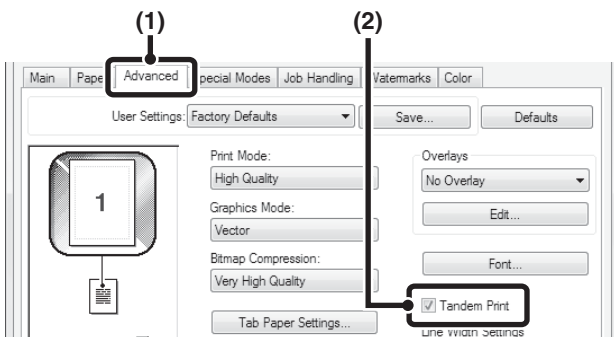

- (1) Click the [Advanced] tab.
- (2) Select the [Tandem Print] checkbox .

The tandem print function can be used only when the printer driver is installed using a "Custom installation" with "LPR Direct Print (Specify Address/Auto Search)" and checking "Yes" for "Do you want to use 'Tandem Print' function?"

### Macintosh

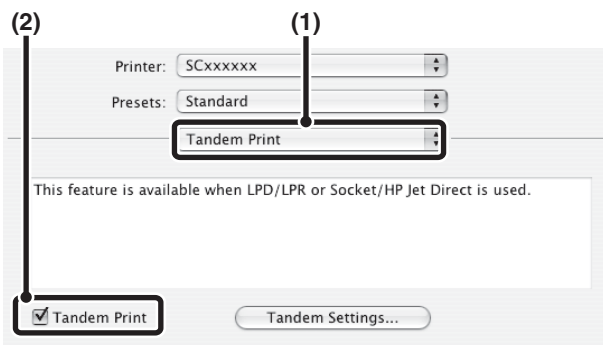

- (1) Select [Tandem Print].
- (2) Select the [Tandem Print] checkbox .

To use the tandem print function, the protocol to be used must be selected in accordance with the message that appears in the left screen when adding the printer driver with the "Printer Setup Utility".

## SAVING AND USING PRINT FILES (Retention/Document Filing)

(On the MX-2314N, the productivity kit is required.)

This function is used to store a print job as a file on the machine's hard drive, allowing the job to be printed from the operation panel when needed. The location for storing a file can be selected to prevent the file from being mixed together with files of other users.

When printing from a computer, a password (5 to 8 digits) can be set to maintain the secrecy of information in a stored file.

When a password is set, the password must be entered to print a stored file from the machine.

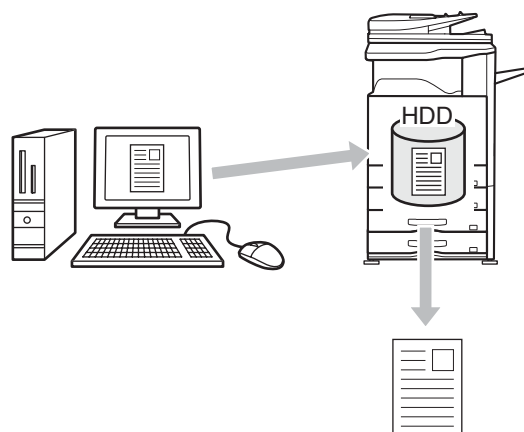

### Hold Only

This setting is used to hold a print job on the machine's hard drive without printing it.

### Hold After Print

This setting is used to hold a print job on the machine's hard drive after it is printed.

### Sample Print

When a print job is sent to the machine, only the first set of copies is printed. After checking the contents of the first set of copies, you can print the remaining sets from the operation panel of the machine. This prevents the occurrence of excessive misprints.

To print files stored on the machine's hard drive, see "[PRINTING A STORED FILE](#)" (page 6-31) in "6. DOCUMENT FILING".

Windows

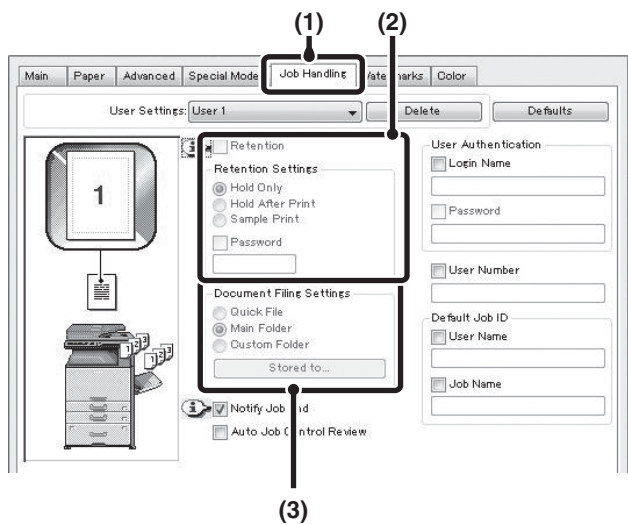

(1) Click the [Job Handling] tab.

(2) Select the retention setting.

Click the [Retention] checkbox . Select the retention method in "Retention Settings". To enter a password (5 to 8 digit number), click the [Password] checkbox .

(3) Select document filing settings.

Select the folder for storing the file in "Document Filing Settings". If you selected [Custom Folder], click the [Stored to] button to select the folder.



- When [Quick File] is selected, "Retention Settings" will be set to [Hold After Print] only.
- When [Quick File] is selected, the password entered in "Retention Settings" is cleared and cannot be used.
- To store a file in a custom folder, the custom folder must first be created using "Document Filing Control" in the system settings (administrator). If a password has been established for a custom folder, enter the "Folder Password" in the folder selection screen.
- When [Retention] has been checked on [Printing Policy] on the [Configuration] tab, the [Retention] checkbox is always checked and you cannot change the checkbox.
- In an IPV6 environment, files can only be stored in the main folder.

## Macintosh

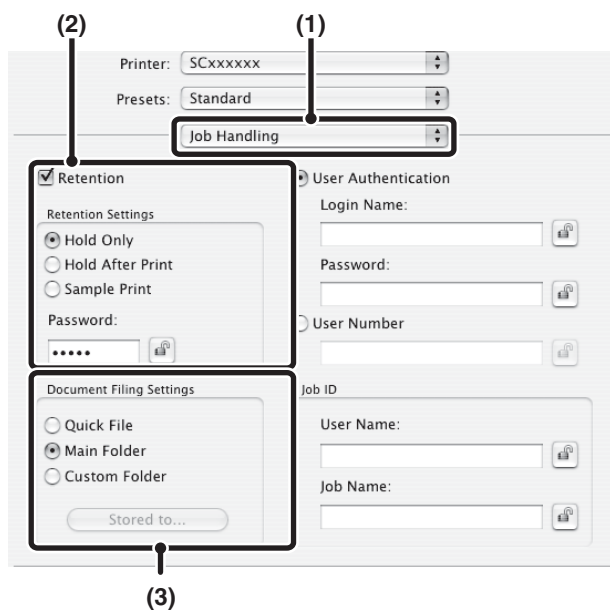

**(1) Select [Job Handling].**

**(2) Select the retention setting.**

Click the [Retention] checkbox . Select the retention method in "Retention Settings". To simplify operation the next time the same password is set, click the (lock) button after entering the password (5 to 8 digit number).

**(3) Select document filing settings.**

Select the folder for storing the file in "Document Filing Settings". If you selected [Custom Folder], click the [Stored to] button to select the folder.



- When [Quick File] is selected, "Retention Settings" will be set to [Hold After Print] only.
- When [Quick File] is selected, the password entered in "Retention Settings" is cleared and cannot be used.
- To store a file in a custom folder, the custom folder must first be created using "Document Filing Control" in the system settings (administrator). If a password has been established for a custom folder, enter the "Folder Password" in the folder selection screen.
- In Mac OS X v10.5, 10.6, 10.7 and 10.8, if you wish to store document filing settings in a custom folder, click the [Custom Folder] tab.

## Automatically print all stored data

When user authentication is enabled in the system settings (administrator), all retained (stored) print jobs of a user who logs in can be printed automatically after log in. After all jobs are printed, the files are deleted.

To use the print all function, the following steps are necessary:

- "Automatically print stored jobs after login" must be enabled in the system settings (administrator) of the machine.
- At the time of retention print, in addition to user authentication information, **the user name stored in the machine** must be entered in "User Name" of the job ID in the printer driver.

Windows: [PRINTING WHEN THE USER AUTHENTICATION FUNCTION IS ENABLED](#) (page 3-8)

Macintosh: [PRINTING WHEN THE USER AUTHENTICATION FUNCTION IS ENABLED](#) (page 3-22)

**(1) Log into the machine.**

Enter your user number or login name and password in the user authentication screen of the machine.

**(2) Perform print all.**

A confirmation prompt will appear. Touch the [OK] key. The print files stored in the quick file folder, main folder, and custom folder will be printed automatically and then deleted.

Files with a password and files that are protected by the document filing function of the machine will not be printed. Files in a folder (excluding My Folder) that has a password will also not be printed.

**If you do not wish to "print all"...**  
Touch the [Cancel] key in step (2).

# PRINTING WITHOUT THE PRINTER DRIVER

When you do not have the printer driver installed on your computer, or when the software application used to open a file that you wish to print is not available, you can print directly to the machine without using the printer driver. The file types (and corresponding extensions) that can be printed directly are shown below.

File Type	TIFF	JPEG	PCL	PDF, Encrypted PDF	PS	XPS
Extension	tiff, tif	jpeg, jpg, jpe, jfif	pcl	pdf	ps	xps

- 
  - Even if the print result is black and white, the following types of print jobs will be counted as 4-colour (Y (Yellow), M (Magenta), C (Cyan), and Bk (Black)) print jobs. To be always counted as a black and white job, select black and white printing.
    - When the data is created as colour data.
    - When the application treats the data as colour data even though the data is black and white.
    - When an image is hidden under a black and white image.
    - To print Encrypted PDF files, Productivity kit is required.
  - To print PDF and PS files, the PS3 expansion kit must be installed.
  - To print XPS files, the XPS expansion kit must be installed.
  - Depending on the file type, it may not be possible to print some files in the above table.

---



---

## DIRECTLY PRINTING FROM THE MACHINE

A file on an FTP server, in a network folder or in a USB memory device connected\* to the machine can be selected and printed from the operation panel of the machine without using the printer driver.

\* On the MX-2314N, the productivity kit is required.



# DIRECTLY PRINTING A FILE ON AN FTP SERVER

When an FTP server is configured in the machine's Web pages, you can specify and print a file on the FTP server from the operation panel of the machine. This saves you the trouble of downloading the file and printing it from a computer. For the procedure for accessing the Web pages, see the Start Guide.

 To configure FTP server settings, click [Application Settings] and then [Setting for Print from the MFP(FTP)] in the Web page menu. (Administrator rights are required.) Up to 20 FTP servers can be configured.

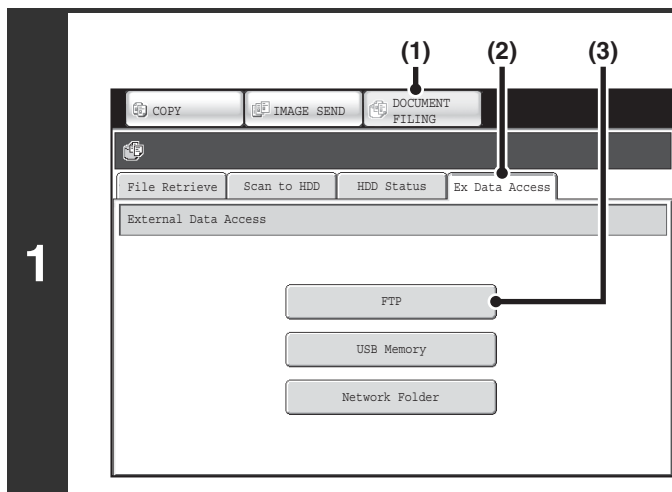

## Access the FTP server.

- (1) Touch the [DOCUMENT FILING] key.
- (2) Touch the [Ex Data Access] tab.
- (3) Touch the [FTP] key.

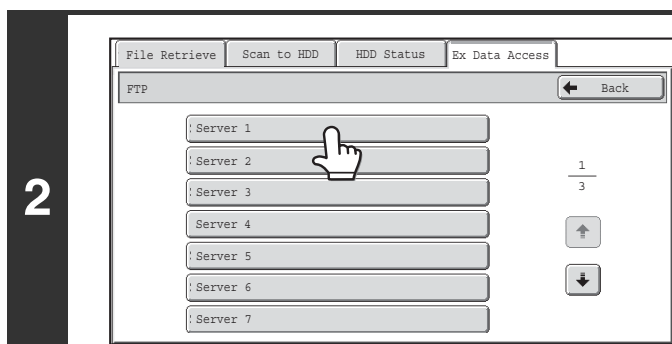

The [FTP] key cannot be touched when any FTP server has not been configured.



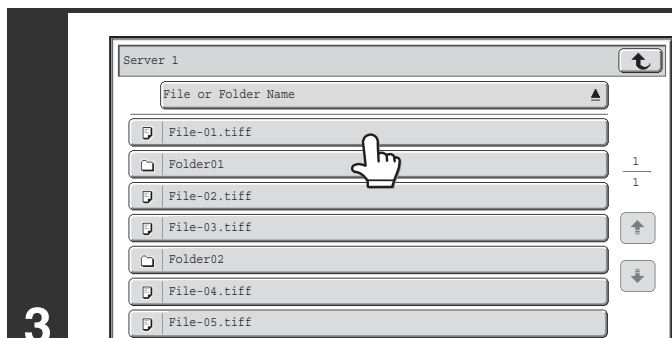

## Touch the key of the FTP server that you wish to access.



## Touch the key of the file that you wish to print.

- The  icon appears to the left of keys of files that can be printed.
- The  icon is displayed to the left of keys of folders on the FTP server. To display the files and folders in a folder, touch the key of the folder.

-  • A total of 100 keys of files and folders can be displayed.
- Touch the  key to move up one folder level.
- When you move down a folder level by touching a folder key, the  key appears in the top right corner of the screen. Touch this key to return to the file or folder name selection screen.
- Touch the [File or Folder Name] key to change the order of the files and folders displayed on the screen. The order switches between ascending order and descending order each time you touch the key.



4

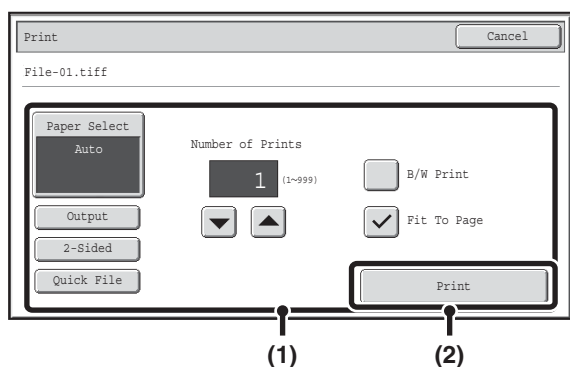

**Print the selected file.**

**(1) Select print conditions.**

If you selected a file (PCL, PS, or XPS) in step 3 that includes print settings, the settings will be applied.

**(2) Touch the [Print] key.**

Printing begins. When the message appears in the touch panel, touch the [OK] key.

When you select a PDF file that has a password, you must enter the password in the job status screen to begin printing. [PRINTING AN ENCRYPTED PDF FILE](#) (page 3-74)

## DIRECTLY PRINTING A FILE IN USB MEMORY

(On the MX-2314N, the productivity kit is required.)

A file in a USB memory device connected to the machine can be printed from the operation panel of the machine without using the printer driver. When the printer driver of the machine is not installed on your computer, you can copy a file into a commercially available USB memory device and connect the device to the machine to print the file directly.

1

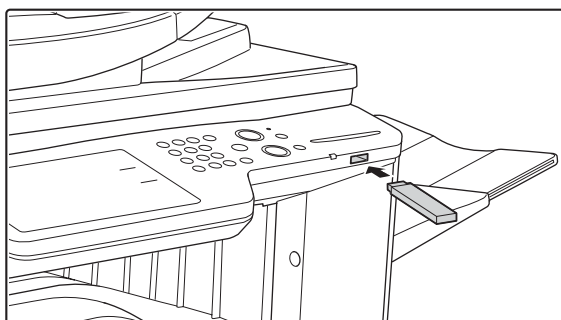

**Connect the USB memory device to the machine.**

Use a FAT32 USB memory with a capacity of no more than 32 GB.

2

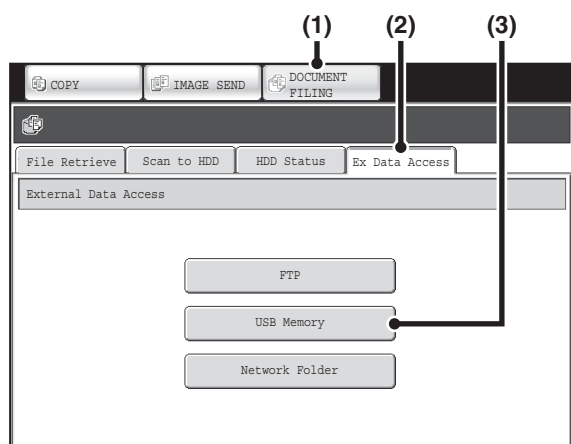

**Access the USB memory device.**

- (1) Touch the [DOCUMENT FILING] key.
- (2) Touch the [Ex Data Access] tab.
- (3) Touch the [USB Memory] key.



**System Settings(Administrator) : Disabling of USB Memory Direct Print**

This setting is used to disable printing of files in a USB memory.  
When this setting is enabled, [USB Memory] key cannot be touched.

3



**Touch the key of the file that you wish to print.**

- The icon appears to the left of keys of files that can be printed.
- The icon is displayed to the left of keys of folders in the USB memory. To display the files and folders in a folder, touch the key of the folder.



- A total of 100 keys of files and folders can be displayed.
- Touch the key to move up one folder level.
- When you move down a folder level by touching a folder key, the key appears in the top right corner of the screen. Touch this key to return to the file or folder name selection screen.
- Touch the [File or Folder Name] key to change the order of the files and folders displayed on the screen. The order switches between ascending order and descending order each time you touch the key.

4

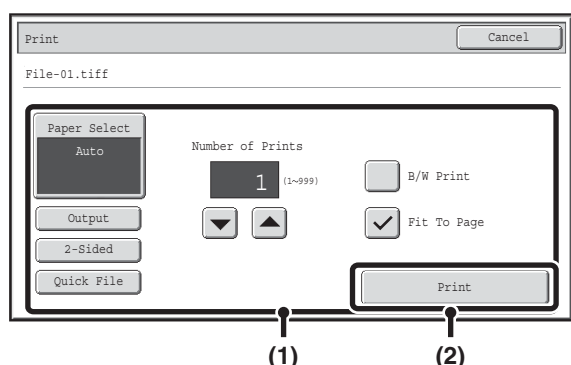

**Print the selected file.**

**(1) Select print conditions.**

If you selected a file (PCL, PS, or XPS) in step 3 that includes print settings, the settings will be applied.

**(2) Touch the [Print] key.**

Printing begins after the selected file is transferred. When the message appears in the touch panel, touch the [OK] key.



**To cancel printing...**

To cancel printing while the file is being transferred, touch the [Cancel] key in the message screen that appears in the touch panel.

5

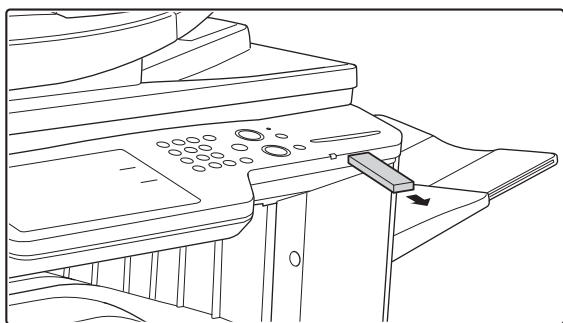

Remove the USB memory device from the machine.

When you select a PDF file that has a password, you must enter the password in the job status screen to begin printing. [PRINTING AN ENCRYPTED PDF FILE](#) (page 3-74)

## DIRECTLY PRINTING A FILE IN A NETWORK FOLDER

(On the MX-2314N, the productivity kit is required.)

You can use the machine's operation panel to select and print a file on a server or in a shared folder of an individual's computer on the same network as the machine.

1

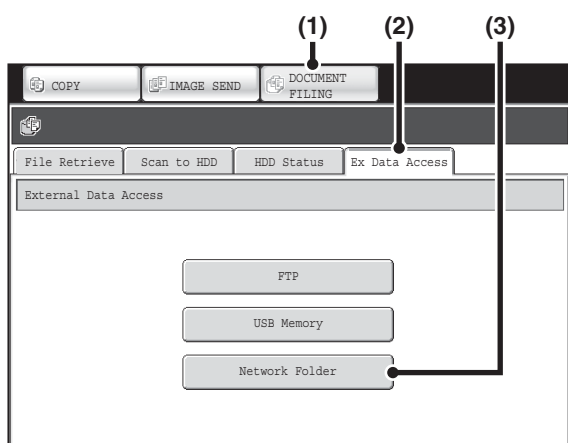

Access the network.

- (1) Touch the [DOCUMENT FILING] key.
- (2) Touch the [Ex Data Access] tab.
- (3) Touch the [Network Folder] key.



**System Settings(Administrator) : Disabling of Network Folder Direct Print**

This setting is used to disable printing of files in a network folder.  
When this setting is enabled, [Network Folder] key cannot be touched.

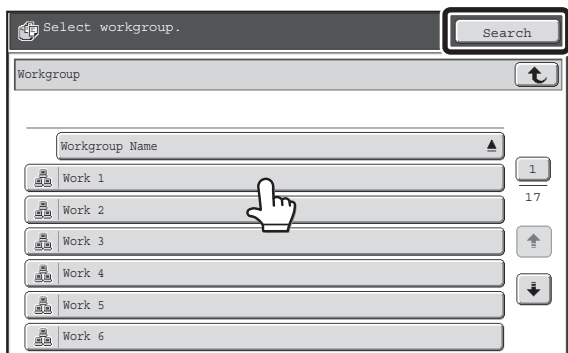

**Access the network folder.**

**(1) Touch the key of the workgroup that you wish to access.**

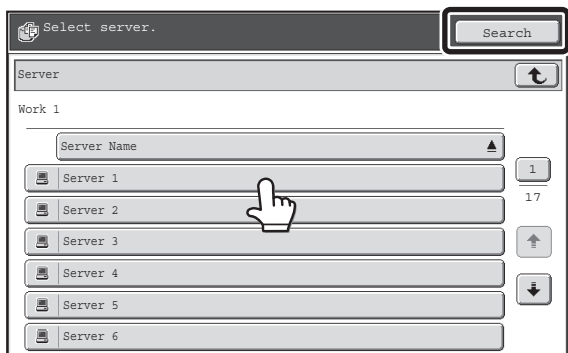

**(2) Touch the key of the server or computer that you wish to access.**

If a screen appears prompting you to enter a user name and password, check with your server administrator and enter the appropriate user name and password.

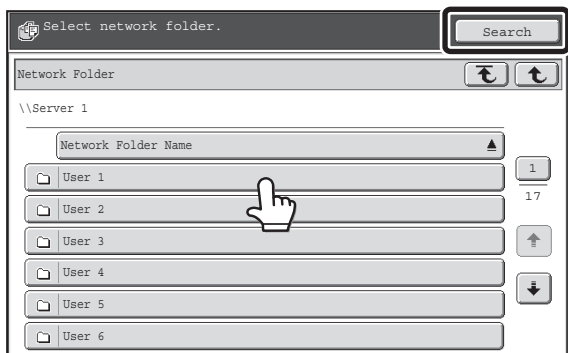

**(3) Touch the key of the network folder.**



- You can touch the [Search] key and enter a keyword to search for a workgroup, server, or network folder. For the procedure for entering text, see "ENTERING TEXT" (page 1-70) in "1. BEFORE USING THE MACHINE".
- Up to 100 workgroups, 100 servers, and 100 network folders can be displayed.
- Touch the key to move up one folder level.
- To return to the workgroup selection screen, touch the key.
- To change the sorting order of the displayed keys, touch the key that shows or in each screen. The order switches between ascending order and descending order each time you touch the key.
- To go to a particular page, touch the key that shows the current page number and enter the desired page number.

3

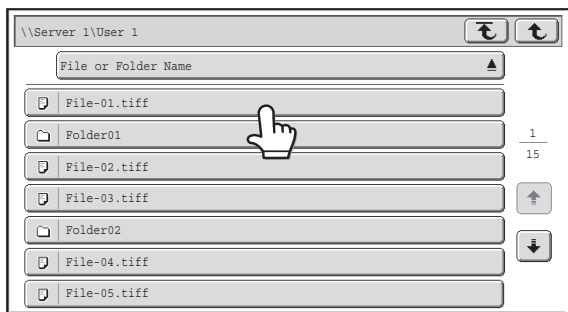

**Touch the key of the file that you wish to print.**

- The icon appears to the left of keys of files that can be printed.
- The icon is displayed to the left of keys of folders in the network folder. To display the files and folders in a folder, touch the key of the folder.



- A total of 100 keys of files and folders can be displayed.
- Touch the key to move up one folder level.
- To return to the network folder selection screen, touch the key.
- Touch the [File or Folder Name] key to change the order of the files and folders displayed on the screen. The order switches between ascending order and descending order each time you touch the key.

4

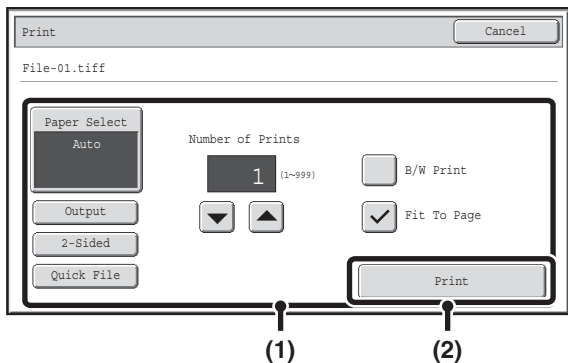

**Print the selected file.**

**(1) Select print conditions.**

If you selected a file (PCL, PS, or XPS) in step 3 that includes print settings, the settings will be applied.

**(2) Touch the [Print] key.**

Printing begins after the selected file is transferred. When the message appears in the touch panel, touch the [OK] key.



When you select a PDF file that has a password, you must enter the password in the job status screen to begin printing.

[PRINTING AN ENCRYPTED PDF FILE](#) (page 3-74)

---

---

# DIRECTLY PRINTING FROM A COMPUTER

Settings can be configured in the Web pages of the machine to enable direct printing from a computer without using the printer driver. For the procedure for accessing the Web pages, see the Start Guide.

## SUBMIT PRINT JOB

You can specify a file to be printed directly without using the printer driver.

In addition to a file on your computer, this procedure can be used to print any file that can be accessed from your computer, such as a file on another computer connected to the same network.

To directly print a file on a computer, click [Document Operations] and then [Submit Print Job] in the Web page menu.

## FTP PRINT

You can print a file from your computer by simply dragging and dropping the file onto the FTP server of the machine.

- **Configuring settings**

To enable FTP Print, click [Application Settings] and then [Setting for Print from the PC] in the Web page menu, and configure the port number. (Administrator rights are required.)

- **Performing FTP Print**

Type "ftp://" and then the IP address of the machine in the address bar of your computer's Web browser as shown below.

**(Example)**

ftp://192.168.1.28

Drag and drop the file that you wish to print onto the "lp" folder that appears in your Web browser. The file will automatically begin printing.



- If you printed a file (PCL, PS, or XPS) that includes print settings, the settings will be applied.
- When user authentication is enabled in the system settings (administrator) of the machine, the print function may be restricted. For more information, ask your administrator.

# E-MAIL PRINT

An e-mail account can be configured in the machine to have the machine periodically check your mail server and automatically print received e-mail attachments without using the printer driver.

## • Configuring settings

To use E-mail Print, you must first configure an e-mail account in the machine. To configure an account, click [Application Settings] and then [E-mail Print Settings] in the Web page menu. (Administrator rights are required.) For the procedure for accessing the Web pages, see the Start Guide.

## • Using E-mail Print

To print a file using E-mail Print, use your e-mail program on your computer to send the file as an attachment to the machine's e-mail address.

Control commands can be entered in the message of the e-mail to specify the number of copies and print format. Commands are entered in the format "command name = value".

As an example, the control commands include the following:

Function	Command name	Values
Copies	COPIES	1-999
Staples*1	STAPLEOPTION	NONE, ONE, TWO
Punch*2	PUNCH	OFF, ON
Output	COLLATE	OFF, ON
2-sided print	DUPLEX	OFF, TOP, LEFT, RIGHT
Account number*3	ACCOUNTNUMBER	Number (5 to 8 digits)
File type	LANGUAGE	PCL, PCLXL, POSTSCRIPT, PDF, TIFF, JPG, XPS
Paper	PAPER	Name of available paper (A4, LETTER, etc.)
Document Filing	FILE	OFF, ON
	FOLDERNAME	Maximum of 28 characters
Quick File	QUICKFILE	OFF, ON
Output tray	OUTTRAY	CENTER, RIGHT
Black & white printing	B/W PRINT	OFF, ON
Fit to page	FITIMAGETOPAGE	OFF, ON

### Example

```
COPIES=2
DUPLEX=LEFT
ACCOUNTNUMBER=11111
PAPER=A4
B/W PRINT=ON
```

\*1 Only effective when a finisher is installed.

\*2 Only effective when a punch module is installed on a finisher.

\*3 Can be omitted except when authentication is by user number.



- Enter the commands in Plain Text format. If entered in Rich Text format (HTML), the commands will have no effect.
- To receive a list of the control commands, enter the command "Config" in the e-mail message.
- If nothing is entered in the body text (message) of the e-mail, printing will take place according to the "Printer Default Settings" in the system settings. If you printed a file (PCL, PS, or XPS) that includes print settings, the settings will be applied.
- Only enter a "File type" when you are specifying a page-description language. Normally there is no need to enter a file type.

# CHECKING THE PRINT STATUS

## JOB STATUS SCREEN

The job status screen is displayed when the [JOB STATUS] key (⌂) on the touch panel is touched. The job status screen shows the status of jobs by mode. When the [JOB STATUS] key (⌂) is touched, the job status screen of the mode that was being used before the key was pressed appears.

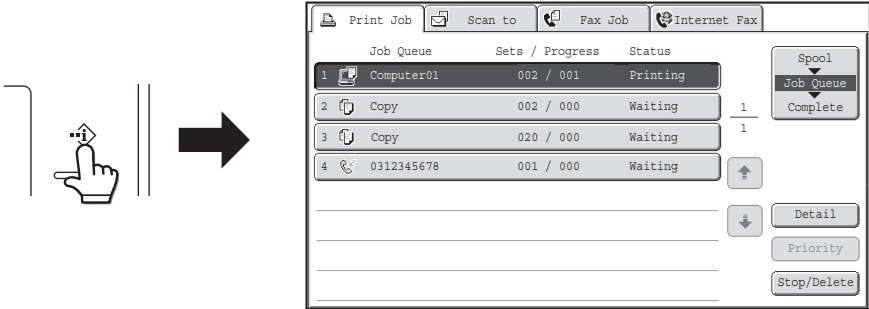

The job status display (A) is in the lower left corner of the touch panel. The job status display can be touched to display the job status screen. You can check the first four print jobs in the print queue (the job in progress and reserved jobs) in the job status display (B).

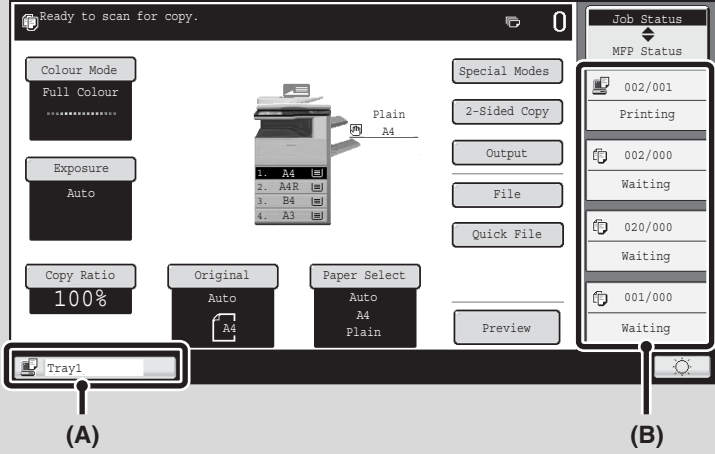



# SPOOL SCREEN/JOB QUEUE SCREEN/COMPLETED JOB SCREEN

The job status screen consists of the job queue screen that shows copy and print jobs waiting to be printed and the job currently in progress, the completed job screen that shows jobs that have been completed, and the spool screen that shows print jobs that have been spooled and encrypted PDF jobs that are waiting for a password to be entered.

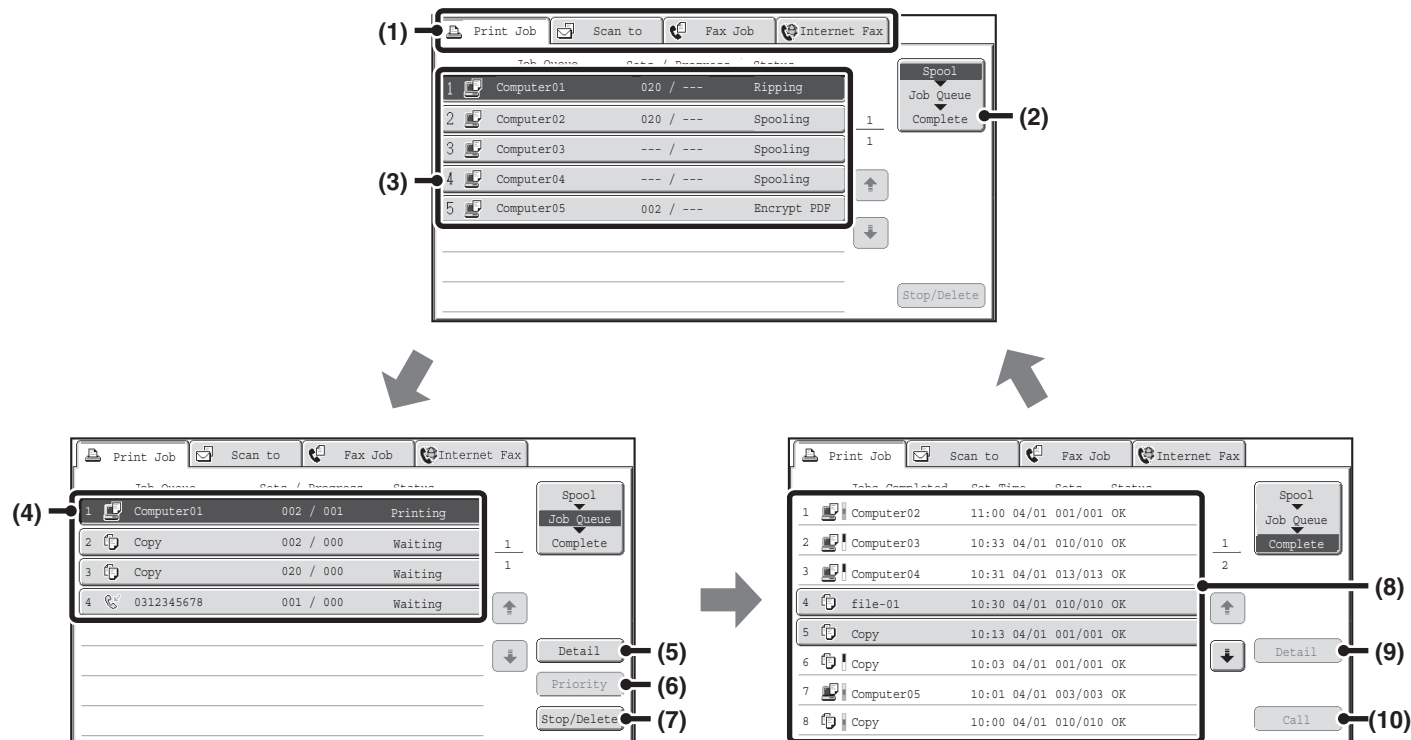

**(1) Mode select tabs**

Use these tabs to select the mode that is shown in the job status screen. The status of print jobs can be checked by touching the [Print Job] tab.

**(2) Job status screen selector key\***

Touch this key to switch through the job queue screen, the completed jobs screen, and the spool screen.

\* On the MX-2314N, the productivity kit is required. [Spool] is not displayed.

**(3) Job list (spool screen)**

Spooled print jobs and encrypted PDF print jobs that require a password to be entered are displayed.

**(4) Job list (job queue screen)**

Jobs waiting to be printed appear in the job queue as keys. The jobs are printed in order from the top of the queue. Each job key shows information on the job and the current status of the job.

**(5) [Detail] key (job queue screen)**

Touch this key to display detailed information on a job.

**(6) [Priority] key**

Touch this key to give priority to a selected job.

**(7) [Stop/Delete] key**

Touch this key to stop or delete a selected job.

**(8) Job list (completed jobs screen)**

This shows up to 99 completed jobs. The result (status) of each completed job is shown.

**(9) [Detail] key (completed jobs screen)**

When a job is shown as a key in the job list, the [Detail] key can be touched to show detailed information on the job.

**(10) [Call] key\***

Touch this key to retrieve and use a print job stored using the document filing function.

\* On the MX-2314N, the productivity kit is required. [Spool] is not displayed.

## Job key display

Each job key shows the position of the job in the job queue and the current status of the job.

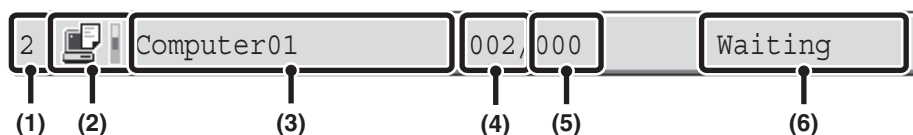

**(1) Indicates the number (position) of the job in the job queue.**

When the job currently being printed is finished, the job moves up one position in the job queue. This number does not appear in keys in the completed jobs screen.

**(2) Mode icon**

The  icon appears when the job is a print job. In the completed jobs screen, a colour bar appears next to the icon to indicate whether the job was executed in colour or black & white. (However, the colour bar icon does not appear in the key of a job that used document filing or in the key of a transmission/reception job that was cancelled.)

**(3) User name**

The computer login name of the user will appear in the print job. A "User Name" can be entered in the printer driver to display the name of the user who executed the job.

**(4) Number of sets entered**

This shows the number of sets specified.

**(5) Number of completed sets**

This shows the number of sets completed. "000" appears while the job is waiting in the job queue.

**(6) Status**

Shows the job status.

Message	Status
"Printing"	Printing is in progress.
"Waiting"	The job is waiting to be executed.
"Toner Empty"	The toner cartridge is out of toner. Replace the toner cartridge with a new cartridge.
"Paper Empty"	The paper used for the job has run out. Add paper or change to a different paper tray.
"Limit"	The printing page limit has been exceeded. Check with the administrator of the machine.
"Error"	An error occurred while the job was being executed. Clear the error condition.
"Rendering"	Analyzing print data.
"Spooling"	Print data is being received or a job is waiting for analysis after being spooled.
"Encrypt PDF"	Upon analysis, if a spooled job is found to be an encrypted PDF, it changes to the password entry wait state.

# PRINTING AN ENCRYPTED PDF FILE

Encrypted PDF is used to protect a PDF file by requiring the entry of a password to print or edit the file. To directly print an encrypted PDF file on an FTP server or in a USB memory device, etc. connected to the machine, follow the steps below to enter the password and begin printing.

 **The PS3 expansion kit is required to use this function. On the MX-2314N, the productivity kit is required.**

1

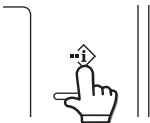

**Touch the [JOB STATUS] key (  ).**

2

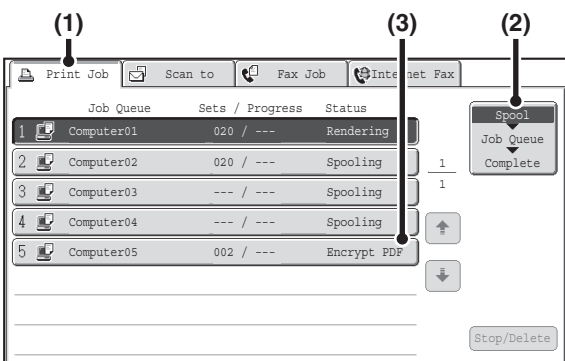

**Select the encrypted PDF print job.**

**(1) Touch the [Print Job] tab.**

**(2) Change the print job status mode to [Spool].**  
Touch this key to change modes. The selected mode will be highlighted.

**(3) Touch the print job key of the PDF file that has the password.**

3

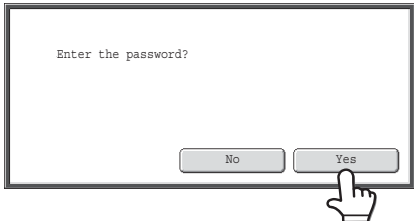

**Touch the [Yes] key.**

A text entry screen appears. Enter the password (32 characters or less) and touch the [OK] key. The print job is released and moved to the [Job Queue].

 When both a master password and a user password (which is used to open the file) have been set, enter the master password.

-  • To print an encrypted PDF file using the printer driver, enter the password when opening the file on your computer.
- Printing is not possible if you do not know the password for an encrypted PDF file. To delete a spooled print job, touch the [No] key in the screen of step 3 and touch the [Stop/Delete] key.
- Encrypted PDF versions that can be directly printed are 1.6 (Adobe® Acrobat® 7.0) and earlier.

# GIVING A PRINT JOB PRIORITY/CANCELLING A PRINT JOB

## GIVING A PRINT JOB PRIORITY

When the machine is busy copying or printing a received fax or other job, you can give priority to a print job that is waiting to be printed and print it ahead of the other jobs.

1

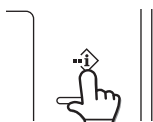

Touch the [JOB STATUS] key (◊).

2

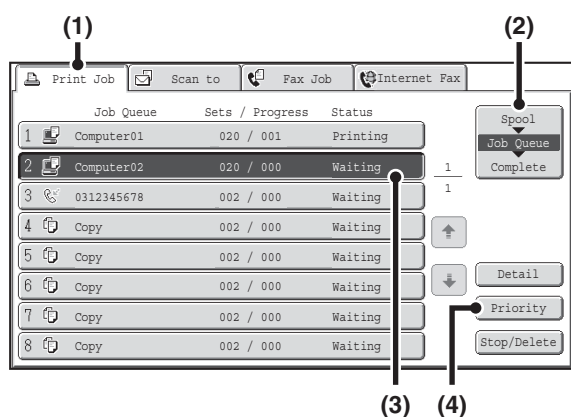

Give the desired job priority.

- (1) Touch the [Print Job] tab.
- (2) Change the print job status mode to [Job Queue].  
Touch this key to change modes. The selected mode will be highlighted.
- (3) Touch the key of the print job to which you want to give priority.
- (4) Touch the [Priority] key.  
The job being printed stops and the job selected in (3) is printed.



To check print information on the selected job, touch the [Detail] key.

# CANCELLING A PRINT JOB

A job being printed, a job waiting to be printed, or a spooled job can be cancelled.

1

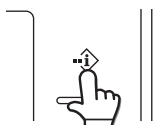

Touch the [JOB STATUS] key (Ⓜ).

2

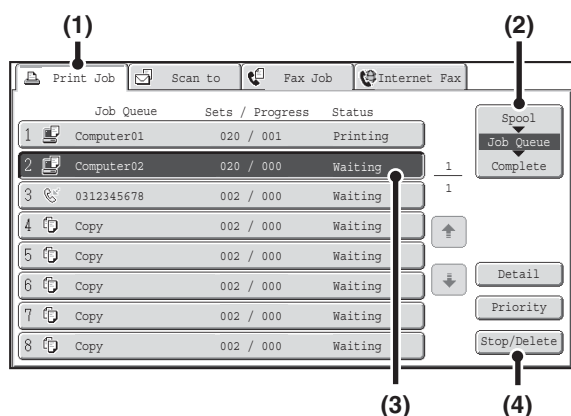

## Cancel the job.

- (1) Touch the [Print Job] tab.
- (2) Change the print job status mode to [Spool] or [Job Queue].  
Touch this key to change modes. The selected mode will be highlighted.
- (3) Touch the key of the print job that you wish to cancel.
- (4) Touch the [Stop/Delete] key.
- (5) A message appears to confirm the cancellation. Touch the [Yes] key.

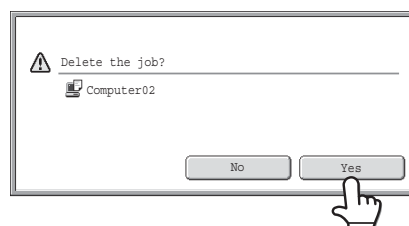

The selected job key is deleted and printing is cancelled.

✎ It is also possible to cancel printing with the [STOP] key (Ⓢ) on the operation panel. When the [STOP] key (Ⓢ) is pressed, a message will appear asking you if you want to cancel the job.

↶ **If you do not want to cancel the selected print job...**  
Touch the [No] key in step (5).

# CHANGING TO ANOTHER PAPER SIZE AND PRINTING WHEN PAPER RUNS OUT

If printing stops because the machine ran out of paper, or if the size of paper specified in the printer driver is not loaded in the machine, a message will appear in the touch panel. Printing will begin automatically when the [OK] key is touched and paper is loaded in the machine. If you wish to print on paper in another tray because the desired size of paper is not immediately available, follow the steps below.

**1**  **Touch the [JOB STATUS] key (◊).**

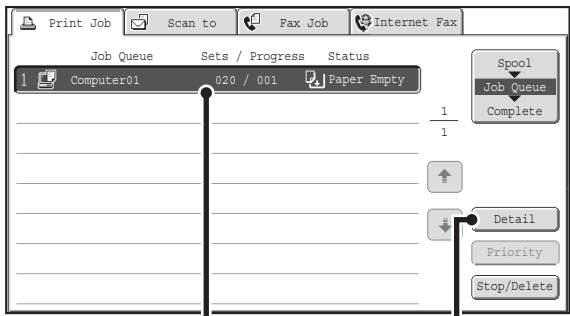
**2**  **Display details on the print job for which there is no paper.**

- (1) Touch the key of the job for which "Paper Empty" appeared.
- (2) Touch the [Detail] key.

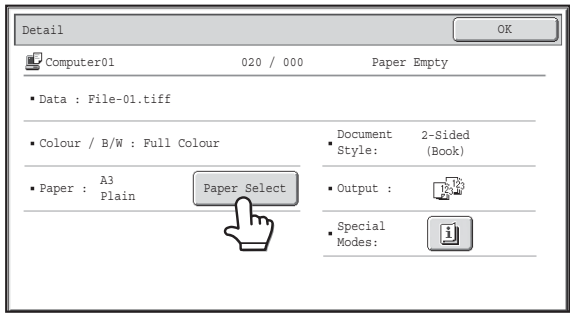
**3**  **Touch the [Paper Select] key.**

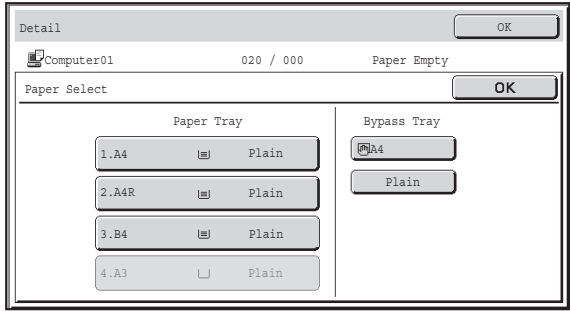
**4**  **Touch the key of the tray that has the paper you wish to use.**

Printing begins.

 If you changed to a different paper size, printing may not take place correctly; for example part of the text or image may run off the paper.

# APPENDIX

## PRINTER DRIVER SPECIFICATION LIST

Available functions and output results may vary depending on the type of printer driver being used.

Function		Sharp Advanced Printing Language-c	PCL6	PS	Windows PPD*1	Macintosh PPD*1	
Frequently used functions	Copies	1-999	1-999	1-999	1-999	1-999	
	Orientation	Yes	Yes	Yes	Yes	Yes	
	N-Up	Number of pages	2,4,6,8,9,16	2,4,6,8,9,16	2,4,6,8,9,16	2,4,6,9,16	2,4,6,9,16
		Order	Selectable	Selectable	Selectable	Selectable	Selectable
		Border	On/Off	On/Off	On/Off	Yes	Selectable
	2-Sided Print	Yes	Yes	Yes	Yes	Yes	
	Fit To Page	Yes	Yes	Yes	No	Yes	
	Binding Edge	Selectable	Selectable	Selectable	No	Yes	
	Black and White Print	Yes	Yes	Yes	Yes	Yes	
	Staple*2	Yes	Yes	Yes	Yes	Yes	
Punch*2	Yes	Yes	Yes	Yes	Yes		
Paper	Paper Size	Yes	Yes	Yes	Yes	Yes	
	Custom Paper	8 size	8 size	8 size	Yes	Yes	
	Paper Selection	Yes	Yes	Yes	Yes	Yes	
	Output tray	Yes	Yes	Yes	Yes	Yes	
Convenient printer functions	Pamphlet	Yes	Yes	Yes	Yes	Yes	
	Margin Shift	Yes	0 mm to 30 mm	0 mm to 30 mm	Yes	Yes	
	Poster Printing	Yes	Yes	Yes	No	No	
	Rotate 180 degrees	Yes	Yes	Yes	Yes	Yes	
	Zoom/XY-Zoom	Yes*3	Yes*3	Yes	Yes*3	Yes*3	
	Line Width Settings	Yes	Yes	No	No	No	
	Mirror Image	No	No	Yes	Yes	No	

Function		Sharp Advanced Printing Language-c	PCL6	PS	Windows PPD*1	Macintosh PPD*1
Special functions	Different Paper	Yes*4	Yes	Yes	No	Yes*4
	Transparency Inserts	Yes	Yes	Yes	No	Yes
	Carbon Copy	No	Yes	Yes	No	No
	Tab Printing	No	Yes	Yes*5	No	No
	Chapter Inserts	No	Yes	No	No	No
	Page Interleave	No	Yes	No	No	No
	Layout Print	No	Yes	No	No	No
	Tandem Print*9	No	Yes	Yes	No	Yes
	Retention*9	Yes	Yes	Yes	No	Yes
	Document Filing	Yes	Yes	Yes	No	Yes
Colour mode adjusting function	Colour Adjustment	Yes	Yes	Yes	No	Yes*6
	Text To Black/ Vector To Black	Yes	Yes	Yes	No	No
	Advanced Colour	Yes	Yes	Yes	Yes	Yes
Functions to combine text and images	Watermark	Yes	Yes	Yes	Yes	Yes
	Image Stamp	Yes	Yes	Yes	No	No
	Overlay*9	No	Yes	Yes	No	No
Image Quality	Print Mode	Normal/ High Quality	Normal/ High Quality	Normal/ High Quality	Normal/ High Quality	Normal/ High Quality
	Graphics Mode Selection	No	Yes	No	No	No
	Toner Save*7	Yes	Yes	Yes	Yes	Yes
Font	Resident font	No	80 fonts	136 fonts	136 fonts	35 fonts
	Selectable download font	No	bitmap, TrueType, Graphics	bitmap, TrueType, Type1	bitmap, TrueType, Type1	No*8
Other functions	Auto Configuration	Yes	Yes	Yes	No	Yes
	User Authentication	Yes	Yes	Yes	No	Yes

\*1 The specifications of each function in Windows PPD and Macintosh PPD vary depending on the operating system version and the software application.

\*2 Can be used when a finisher is installed. (To use the punch function, a punch module must be also installed.)

\*3 The horizontal and vertical proportion cannot be set separately.

\*4 Only covers can be inserted.

\*5 Only the amount of the shift of the text string data created in the software application can be set.

\*6 Only Mac OS X v10.4 can be used.

\*7 This setting may not operate in some software applications and operating systems.

\*8 True Type and Type1 can be selected in some versions of LaserWriter.

\*9 On the MX-2314N, the productivity kit is required.



# PRINTER SPECIFICATIONS

<b>Type</b>	Built-in	
<b>Continuous printing speed</b>	MX-2314N: 23 pages/min MX-2614N: 26 pages/min MX-3114N: 31 pages/min (When printing same document continuously on A4 (8-1/2"x11") plain paper in non-offset mode, excluding processing time.)	
<b>Printing resolution</b>	600x600 dpi, 9600 equivalent x 600dpi	
<b>Printer driver type</b>	PCL6, PostScript 3 compatible*1, XPS*3, Sharp Advanced Printing Language-c*5	
<b>Supported protocols</b>	TCP/IP, IPX/SPX, NetBEUI, EtherTalk*1	
<b>Supported client PC operating systems</b>	See "VERIFYING SYSTEM REQUIREMENTS" in the Software Setup Guide.	
<b>Fonts</b>	PCL6	80 European fonts, 28 barcode fonts*2, 1 bitmap font
	PostScript 3 compatible*1	136 European fonts
<b>Interface port</b>	LAN connectivity: 10Base-T / 100Base-TX / 1000Base-T USB connectivity: Supports USB 2.0 (Hi speed)	
<b>Memory</b>	Standard system memory: 1GB*6 Expansion memory: 2GB*4 *6	
<b>Print area</b>	Entire page excluding margin of 4.2mm (11/64") at each edge. The actual print area may vary depending on the printer driver and the software application.	

\*1 When the PS3 expansion kit is installed and the machine is used as a PostScript printer.

\*2 Barcode font kit is required.

\*3 When the XPS expansion kit is installed.

\*4 Required when there is insufficient memory to handle certain print data. Must be used when the XPS expansion kit is installed.

\*5 MX-2314N only

\*6 On the MX-2314N, the productivity kit is required.

# CHAPTER 4

# FACSIMILE

This chapter provides detailed explanations of the procedures for using the fax function.

**To use the fax function, the facsimile expansion kit must be installed.**

## BEFORE USING THE MACHINE AS A FAX

<b>PREPARATIONS FOR FAX</b> .....	<b>4-4</b>
• CONNECTION TO THE TELEPHONE LINE .....	4-4
• MAKE SURE THE MAIN POWER SWITCH IS IN THE "ON" POSITION .....	4-5
• CHECKING THE DATE AND TIME .....	4-6
• STORING THE SENDER FAX NUMBER .....	4-6
<b>BASE SCREEN OF FAX MODE</b> .....	<b>4-7</b>
• BASE SCREEN OF FAX MODE .....	4-8
• ADDRESS BOOK SCREEN .....	4-10
• CHANGING THE DISPLAY OF ONE-TOUCH KEYS IN THE ADDRESS BOOK SCREEN .....	4-11
<b>FAX TRANSMISSION SEQUENCE</b> .....	<b>4-13</b>

## ENTERING DESTINATIONS

<b>ENTERING A FAX NUMBER WITH THE NUMERIC KEYS</b> .....	<b>4-17</b>
<b>RETRIEVING A FAX NUMBER FROM THE ADDRESS BOOK</b> .....	<b>4-18</b>
• RETRIEVING A STORED DESTINATION .....	4-19
• CHECKING AND DELETING ENTERED DESTINATIONS .....	4-20
<b>USING A SEARCH NUMBER TO RETRIEVE A DESTINATION</b> .....	<b>4-21</b>
<b>RETRIEVING A DESTINATION FROM A GLOBAL ADDRESS BOOK</b> .....	<b>4-22</b>
<b>USING THE RESEND FUNCTION</b> .....	<b>4-24</b>
<b>CHAIN DIALLING</b> .....	<b>4-25</b>

## BASIC TRANSMISSION METHODS

<b>TRANSMISSION METHODS</b> .....	<b>4-26</b>
• PLACEMENT ORIENTATION OF THE ORIGINAL .....	4-28
• AUTOMATIC REDUCTION OF THE TRANSMITTED IMAGE .....	4-28
• TRANSMITTABLE ORIGINAL SIZES .....	4-29
• THE SIZE OF THE PLACED ORIGINAL .....	4-29
• WHEN THE LINE IS BUSY .....	4-30
• WHEN A COMMUNICATION ERROR OCCURS .....	4-30
• FAX DESTINATION CONFIRMATION MODE .....	4-31
<b>USING THE AUTOMATIC DOCUMENT FEEDER FOR TRANSMISSION</b> .....	<b>4-32</b>
• USING THE AUTOMATIC DOCUMENT FEEDER TO SEND A FAX IN DIRECT TRANSMISSION MODE .....	4-33
<b>USING THE DOCUMENT GLASS FOR TRANSMISSION</b> .....	<b>4-35</b>
• USING THE DOCUMENT GLASS TO SEND A FAX IN DIRECT TRANSMISSION MODE .....	4-37
<b>TRANSMISSION USING THE SPEAKER</b> .....	<b>4-39</b>
<b>SENDING THE SAME FAX TO MULTIPLE DESTINATIONS (Broadcast Transmission)</b> .....	<b>4-40</b>
<b>SENDING A FAX DIRECTLY FROM A COMPUTER (PC-Fax)</b> .....	<b>4-45</b>
<b>IMAGE SETTINGS</b> .....	<b>4-46</b>
• AUTOMATICALLY SCANNING BOTH SIDES OF AN ORIGINAL (2-Sided Original) .....	4-47
• SPECIFYING THE SCAN SIZE AND SEND SIZE (Enlarge/Reduce) .....	4-48
• CHANGING THE EXPOSURE .....	4-55
• CHANGING THE RESOLUTION .....	4-56
<b>CHECKING THE IMAGE TO BE TRANSMITTED (Preview)</b> .....	<b>4-57</b>
• PREVIEW CHECK SCREEN .....	4-58

**FAX RECEPTION**

<b>RECEIVING FAXES</b> .....	4-59
• RECEIVING A FAX .....	4-60
• RECEIVING A FAX MANUALLY .....	4-61
<b>PRINTING A PASSWORD-PROTECTED FAX (Hold Setting For Received Data Print)</b> .....	4-62
<b>CHECKING THE IMAGE BEFORE PRINTING</b> ...	4-63
<b>CHECKING THE IMAGE BEFORE FORWARDING</b> .....	4-64
• IMAGE CHECK SCREEN .....	4-66
<b>FORWARDING RECEIVED FAXES (Fax Data Forward)</b> .....	4-67
<b>FORWARDING RECEIVED FAXES TO AN ADDRESS (Inbound Routing Settings)</b> .....	4-68
• CONFIGURING INBOUND ROUTING SETTINGS .....	4-68

**SPECIAL MODES**

<b>SPECIAL MODES</b> .....	4-72
<b>STORING FAX OPERATIONS (Program)</b> .....	4-74
<b>ERASING PERIPHERAL SHADOWS ON THE IMAGE (Erase)</b> .....	4-76
<b>TRANSMITTING AN ORIGINAL AS TWO SEPARATE PAGES (Dual Page Scan)</b> .....	4-78
<b>SENDING A FAX AT A SPECIFIED TIME (Timer)</b> .....	4-80
<b>SENDING TWO PAGES AS A SINGLE PAGE (2in1)</b> .....	4-82
<b>SENDING BOTH SIDES OF A CARD AS A SINGLE PAGE (Card Shot)</b> .....	4-85
<b>SENDING A LARGE NUMBER OF PAGES (Job Build)</b> .....	4-88
<b>TRANSMITTING ORIGINALS OF DIFFERENT SIZES (Mixed Size Original)</b> .....	4-90
<b>FAXING THIN ORIGINALS (Slow Scan Mode)</b> ...	4-92
<b>CHECKING THE NUMBER OF SCANNED ORIGINAL SHEETS BEFORE TRANSMISSION (Original Count)</b> .....	4-94
<b>STAMPING SCANNED ORIGINALS (Verif. Stamp)</b> .....	4-96
<b>CHANGING THE PRINT SETTINGS FOR THE TRANSACTION REPORT (Transaction Report)</b> .....	4-98

<b>ADDING YOUR SENDER INFORMATION TO FAXES (Own number sending)</b> .....	4-100
• TEMPORARILY CHANGING THE SENDER INFORMATION (Own Name Select) .....	4-101
<b>CALLING A FAX MACHINE AND INITIATING RECEPTION (Polling)</b> .....	4-102
• INITIATING POLLING RECEPTION MANUALLY .....	4-104
<b>SENDING A FAX WHEN ANOTHER MACHINE POLLS YOUR MACHINE (Polling Memory)</b> .....	4-105
• RESTRICTING POLLING ACCESS (Polling security) .....	4-105
• SCANNING A DOCUMENT INTO POLLING MEMORY .....	4-106
• CHECKING THE DOCUMENT IN THE PUBLIC BOX .....	4-108
• DELETING A DOCUMENT FROM THE PUBLIC BOX .....	4-109

**PERFORMING F-CODE COMMUNICATION**

<b>F-CODE COMMUNICATION</b> .....	4-110
• HOW F-CODES WORK .....	4-110
• CREATING MEMORY BOXES IN THE MACHINE FOR F-CODE COMMUNICATION .....	4-111
• F-CODE DIALLING .....	4-111
<b>CONFIDENTIAL COMMUNICATION USING F-CODES</b> .....	4-112
• F-CODE CONFIDENTIAL TRANSMISSION .....	4-113
• CHECKING FAXES RECEIVED BY F-CODE CONFIDENTIAL RECEPTION ...	4-114
<b>POLLING RECEPTION USING F-CODES</b> .....	4-116
<b>POLLING MEMORY TRANSMISSION USING F-CODES</b> .....	4-118
• SCANNING A DOCUMENT INTO A MEMORY BOX FOR F-CODE POLLING TRANSMISSION .....	4-118
• CHECKING THE DOCUMENT IN THE F-CODE MEMORY POLLING BOX .....	4-121
• DELETING A DOCUMENT STORED FOR F-CODE POLLING TRANSMISSION .....	4-122
<b>RELAY REQUEST TRANSMISSION USING F-CODES</b> .....	4-123
<b>RELAY BROADCAST TRANSMISSION USING F-CODES</b> .....	4-125

## USING AN EXTENSION PHONE

<b>CONNECTING AND USING AN EXISTING PHONE (Extension Phone Connection) . . . . .</b>	<b>4-126</b>
• RECEIVING A FAX AFTER ANSWERING A CALL ON THE EXTENSION PHONE (Remote Reception) . . . . .	4-127
• MAKING AND RECEIVING PHONE CALLS . . . . .	4-127

## CHECKING THE STATUS OF FAX JOBS

<b>JOB STATUS SCREEN . . . . .</b>	<b>4-128</b>
• JOB QUEUE SCREEN AND COMPLETED JOB SCREEN . . . . .	4-129
• OPERATION WHEN A JOB IN THE JOB QUEUE IS COMPLETED . . . . .	4-132
• CHECKING A RESERVED JOB OR THE JOB IN PROGRESS . . . . .	4-133
• CHECKING COMPLETED JOBS . . . . .	4-134
<b>CANCELLING A FAX IN PROGRESS OR A RESERVED FAX . . . . .</b>	<b>4-135</b>
<b>GIVING PRIORITY TO A RESERVED FAX JOB . . . . .</b>	<b>4-136</b>
<b>CHECKING THE ACTIVITY LOG (Image Sending Activity Report) . . . . .</b>	<b>4-137</b>
• IMAGE SENDING ACTIVITY REPORT . . . . .	4-137
• INFORMATION APPEARING IN THE RESULT COLUMN . . . . .	4-138
<b>FACSIMILE SPECIFICATIONS . . . . .</b>	<b>4-139</b>

# BEFORE USING THE MACHINE AS A FAX

This section provides information that you should know before using the machine as a fax machine.

## PREPARATIONS FOR FAX

To use the machine as a fax, the telephone line must be connected and the type of line set.

### CONNECTION TO THE TELEPHONE LINE

Be sure to use the provided telephone line cord to connect the machine to the wall telephone socket. Connect the end of the line cord that has the core to the "LINE" socket on the machine. Insert the other end (the end without the core) into a telephone line socket.

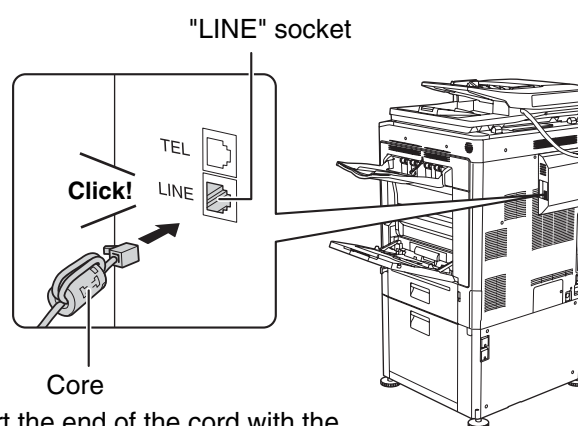

Insert the end of the cord with the core into the "LINE" socket.

An adapter is required to connect the telephone line cable to the wall telephone socket, as shown in the illustration.

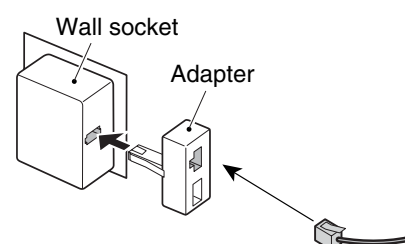

# MAKE SURE THE MAIN POWER SWITCH IS IN THE "ON" POSITION

When the main power indicator on the operation panel is lit, the main power is on.

If the main power indicator light is not lit, the main power is "off". Switch the main power switch to the "on" position and press the [POWER] key (⏻) on the operation panel.

If the fax function will be used, and in particular if reception or timer transmission will take place at night, always keep the main power switch in the "on" position.

 When the [POWER SAVE] key (⏻) indicator light is blinking, the machine is in auto power shut-off mode. If the [POWER SAVE] key (⏻) is pressed when the indicator is blinking, the indicator will turn off and the machine will return to the ready state after a brief interval.

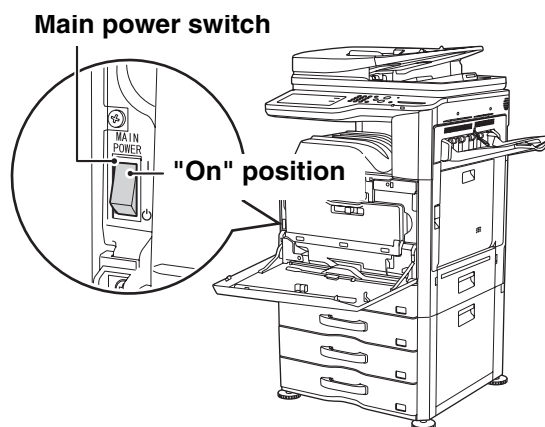
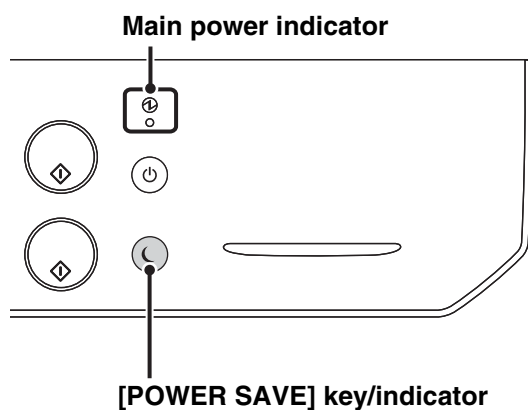

## CHECKING THE DATE AND TIME

Verify that the correct date and time are set in the machine.

The date and time are set in the system settings of the machine. When the [SYSTEM SETTINGS] key (  ) is touched, the system settings menu screen appears on the touch panel. Select [Default Settings], [Clock], and [Clock Adjust], and set the year, month, day, hour, and minute.

 If "Disabling of Clock Adjustment" has been enabled in the system settings (administrator), the date and time cannot be set.

## STORING THE SENDER FAX NUMBER

Store the user name and fax number in "Sender Data Registration".

Be sure to configure this information, as it is required for communication.

 **System Settings (Administrator): Sender Data Registration**  
Use this setting to program the sender name and sender fax number.

# BASE SCREEN OF FAX MODE

To use the fax function, select settings and operations in the base screen of fax mode. To display the base screen of fax mode, touch the [IMAGE SEND] key and then touch the [Fax] tab.

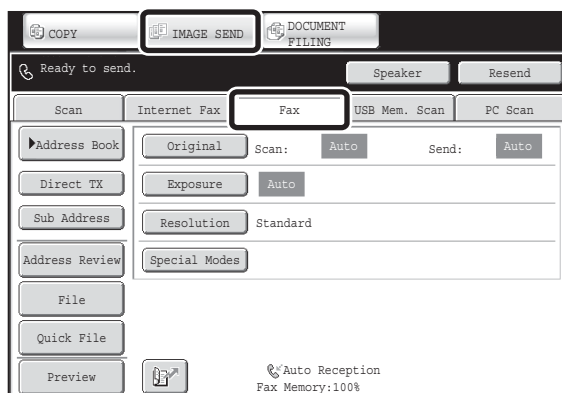

This screen only appears when the fax function and Internet fax function have been installed.

The contents of the screen will vary depending on the devices that are installed.

Each of the other modes that can be displayed by touching the [IMAGE SEND] key (scan, Internet fax, USB memory, PC scan and data entry modes) also have base screens.

Transmission destinations can be stored in one-touch keys in the address book and retrieved from the address book screen when you need to use them. The address book is shared by fax mode, scan mode, Internet fax mode and data entry mode.

To display the address book screen, touch the [Address Book] key in the base screen. To display the base screen, touch the [Condition Settings] key in the address book screen. This chapter refers to the base screen of fax mode as the "base screen".

## Base screen of fax mode

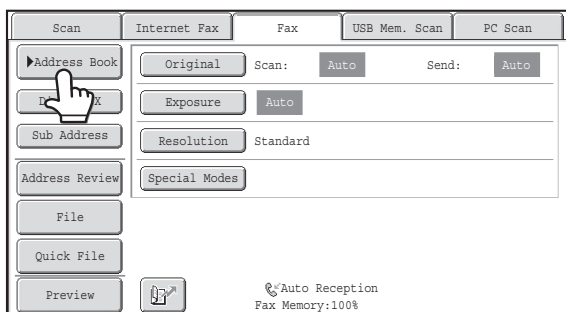

## Address book screen

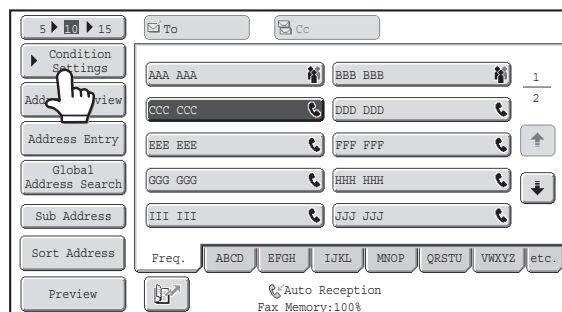

The procedures in this chapter begin from the base screen of fax mode.



### System Settings (Administrator): Default Display Settings

One of the following screens can be selected for the initial screen that appears when the [IMAGE SEND] key is touched.

- Base screen of each mode (scan, Internet fax, fax, or data entry mode)
- Address book screen



# BASE SCREEN OF FAX MODE

This screen is used to select settings and operations in fax mode.

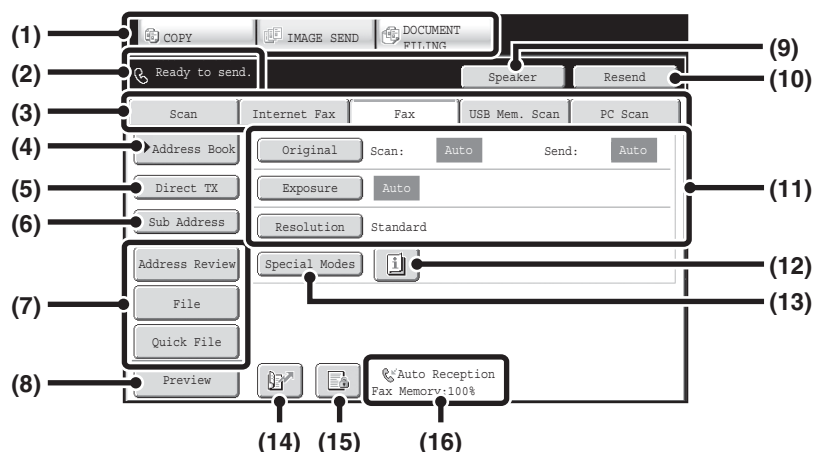

## (1) Mode select keys

Use these keys to switch between copy, image send, and document filing modes.  
To switch to fax mode, touch the [IMAGE SEND] key.

## (2) This shows various messages and the destinations that have been entered.

The  icon on the left indicates fax mode.

## (3) Send mode tabs

Use these keys to change the mode of the image send function.

Tabs of modes that cannot be used because the appropriate options are not installed do not appear.  
If the [Fax] tab does not appear, touch the  tab to move the screen.

[BASE SCREEN OF FAX MODE](#) (page 4-7)

## (4) [Address Book] key

Touch this key to dial using a one-touch key or group key. When the key is touched, the address book screen appears.

[RETRIEVING A FAX NUMBER FROM THE ADDRESS BOOK](#) (page 4-18)

## (5) [Direct TX] key

Touch this key to send a fax by direct transmission. When the [Direct TX] key is not highlighted, normal transmission (memory TX mode) is selected.

[To fax a large number of sheet originals, use the automatic document feeder.](#) (page 4-26)

[If you wish to send a fax ahead of other previously reserved fax transmissions, use direct transmission mode.](#) (page 4-27)

## (6) [Sub Address] key

Touch this key to enter a sub-address and passcode for F-code transmission.

[F-CODE DIALLING](#) (page 4-111)

## (7) Customized keys

The keys that appear here can be changed to show settings or functions that you prefer.

[Customizing displayed keys](#) (page 4-9)

## (8) [Preview] key\*

Touch to check the image that will be sent in the touch panel before transmission.

[CHECKING THE IMAGE TO BE TRANSMITTED \(Preview\)](#) (page 4-57)

\* On the MX-2314N, the productivity kit is required.

## (9) [Speaker] key / [Pause] key / [Space] key

Touch this key to dial using the speaker.

When entering a fax number to be dialled, the key changes to the [Pause] key. When entering a sub-address, the key changes to the [Space] key.

[TRANSMISSION USING THE SPEAKER](#) (page 4-39)

## (10) [Resend] key / [Next Address] key

Touch this key to redial a fax number. When entering a fax number to be dialled, this key changes to the [Next Address] key.

[USING THE RESEND FUNCTION](#) (page 4-24)

## (11) Image settings

Image settings (original size, exposure, resolution) can be selected.

[IMAGE SETTINGS](#) (page 4-46)

## (12) key

This key appears when a special mode or 2-sided scanning is selected. Touch the key to display the selected special modes.

[Checking what special modes are selected](#) (page 4-9)

## (13) [Special Modes] key

Touch this key to use a special mode.

[SPECIAL MODES](#) (page 4-72)



## (14) key

Touch this key to dial a fax destination using a search number.

[USING A SEARCH NUMBER TO RETRIEVE A DESTINATION](#) (page 4-21)

(15)  /  /  key

When "Hold Setting for Received Data Print" or "Received Data Image Check Setting" is enabled in the system settings (administrator), this will appear when a fax is received.

-  : Only "Hold Setting for Received Data Print" is enabled
-  : Only "Received Data Image Check Setting" is enabled
-  : Both settings are enabled

 [PRINTING A PASSWORD-PROTECTED FAX \(Hold Setting For Received Data Print\)](#) (page 4-62)

 [CHECKING THE IMAGE BEFORE PRINTING](#) (page 4-63)

(16) This shows the currently selected fax reception mode and the amount of free memory remaining.

 [RECEIVING FAXES](#) (page 4-59)

## Customizing displayed keys

Special mode keys and other keys can be displayed in the base screen. You can assign frequently used functions to these keys to access the functions with a single touch. To change the function that is assigned to a key, use "Customize Key Setting" in the Web pages. The following keys appear by factory default:

• **[Address Review] key**

Touch this to view a list of the destinations that have been selected in the address book and the numbers that have been directly entered with the numeric keys. This is the same key as the [Address Review] key in the address book screen.



• **[File] key, [Quick File] key**

Touch either key to use Quick File or File in document filing mode. (On the MX-2314N, the productivity kit is required.)

**Example: When "Dual Page Scan", "Job Build", and "Mixed Size Original" are assigned to the customized keys.**

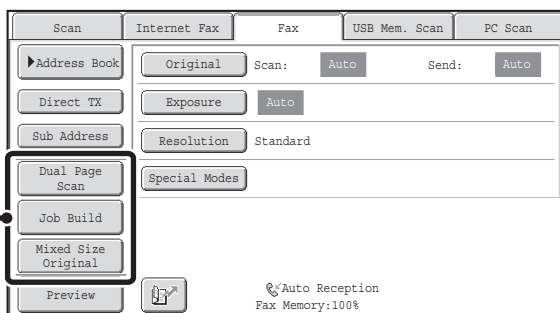
These 3 keys can be changed as desired.



 Displaying a program key in the base screen will enable you to call up the program by simply touching the key.  [STORING FAX OPERATIONS \(Program\)](#) (page 4-74)

---

 **System Settings (Administrator): Customize Key Setting**  
 Registration is performed in [System Settings] - [Operation Settings] - "Customize Key Setting" in the Web page menu. To register a customized key setting, an optional feature may be required. Please refer to the respective descriptions of individual functions for details.

## Checking what special modes are selected

The  key appears in the base screen when a special mode or 2-sided scanning is selected.

The  key can be touched to display the selected special modes. To close the screen, touch the [OK] key.

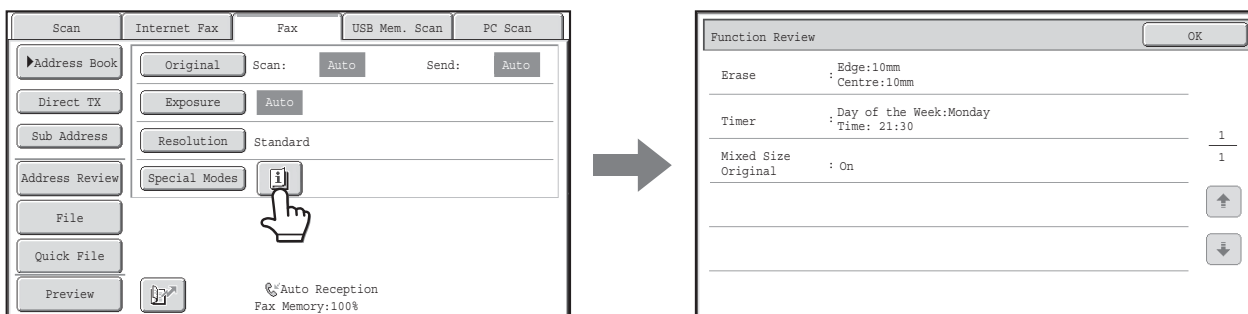

 The special mode settings cannot be changed from the function review screen. To change a setting, touch the [OK] key to close the function review screen and then touch the [Special Modes] key and select the setting that you wish to change.

# ADDRESS BOOK SCREEN

This screen is used to select a destination from the list of stored destinations.

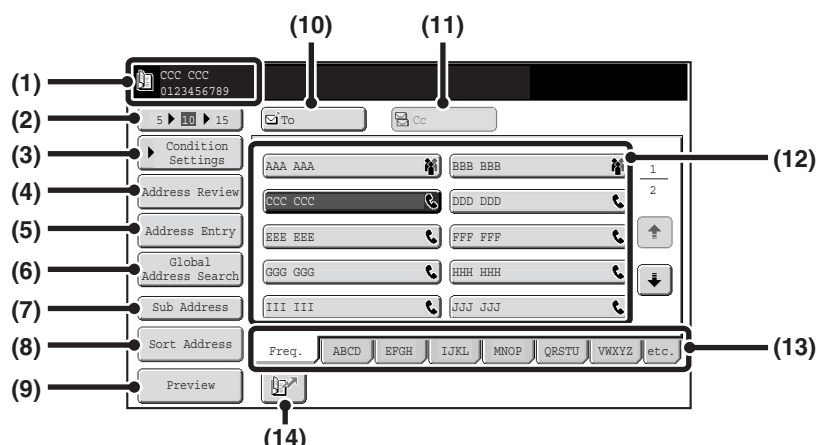

- (1) **This shows the destination that has been selected.**
- (2) **Number of displayed items selector key**  
Touch to change the number of destinations (one-touch keys) displayed in the address book screen. Select 5, 10, or 15 destinations.
- (3) **[Condition Settings] key**  
Touch this key to select transmission settings and operations. When the key is touched, the base screen appears.  
☞ [BASE SCREEN OF FAX MODE](#) (page 4-8)
- (4) **[Address Review] key**  
Touch this key to view a list of the selected destinations. The selected destinations can be changed.  
☞ [CHECKING AND DELETING ENTERED DESTINATIONS](#) (page 4-20)
- (5) **[Address Entry] key**  
Not used in fax mode.
- (6) **[Global Address Search] key**  
When the use of an LDAP server has been enabled in the machine's Web page, a fax number can be obtained from a global address book.  
☞ [RETRIEVING A DESTINATION FROM A GLOBAL ADDRESS BOOK](#) (page 4-22)
- (7) **[Sub Address] key**  
Touch this key to enter a sub-address and passcode for F-code transmission.  
☞ [F-CODE DIALLING](#) (page 4-111)
- (8) **[Sort Address] key**  
Touch this key to change the index tabs to custom indexes or to display one-touch keys by send mode.  
☞ [CHANGING THE DISPLAY OF ONE-TOUCH KEYS IN THE ADDRESS BOOK SCREEN](#) (page 4-11)
- (9) **[Preview] key\***  
Touch to check the image that will be sent in the touch panel before transmission.  
☞ (page 4-59)  
\* On the MX-2314N, the productivity kit is required.
- (10) **[To] key**  
Touch this key to enter a selected destination (one-touch key).  
☞ [RETRIEVING A STORED DESTINATION](#) (page 4-19)
- (11) **[Cc] key**  
Not used in fax mode.
- (12) **One-touch key display**  
This shows the one-touch keys of the destinations that have been stored in the address book. This chapter refers to keys in which single destinations and groups are stored as one touch keys. Keys that have fax numbers stored are indicated by ☎.  
☞ [RETRIEVING A STORED DESTINATION](#) (page 4-19)
- (13) **Index tabs**  
Touch this to change indexes.  
☞ [RETRIEVING A STORED DESTINATION](#) (page 4-19)
- (14) **Search key**  
Touch this key to retrieve a destination using a search number.  
☞ [USING A SEARCH NUMBER TO RETRIEVE A DESTINATION](#) (page 4-21)

 When using the network scanner function or the Internet fax function, a different icon will appear in the one-touch key display if a non-fax destination (address) is stored.

 [RETRIEVING A FAX NUMBER FROM THE ADDRESS BOOK](#) (page 4-18)



• **System Settings: Address Book** (page 7-16)

This is used to store fax numbers in one-touch keys.

• **System Settings (Administrator): The Number of Direct Address Keys Displayed Setting**

This is used to change the default setting for the number of one-touch keys displayed in the address book screen.

• **System Settings (Administrator): Default Display Settings**

One of the following screens can be selected for the initial screen that appears when the [IMAGE SEND] key is touched.

- Base screen of each mode (scan, Internet fax, fax, or data entry mode)
- Address book screen

• **System Settings (Administrator): Address Book Default Selection**

The following settings are available for the method of sorting the addresses that appear in the address book.

- Index type (alphabetical, custom)
- Address type (all, group, E-mail, FTP/Desktop, Network Folder, Internet fax, fax)

## CHANGING THE DISPLAY OF ONE-TOUCH KEYS IN THE ADDRESS BOOK SCREEN

You can show only destinations of a specific transmission mode in the address book screen, or change the displayed index tabs from the alphabetical tabs to the custom tabs. The procedure for selecting destinations does not change.

1

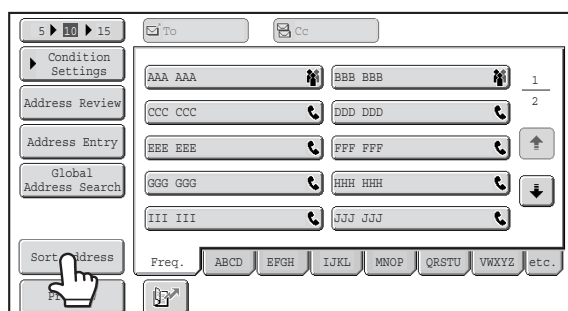

Touch the [Sort Address] key.

2

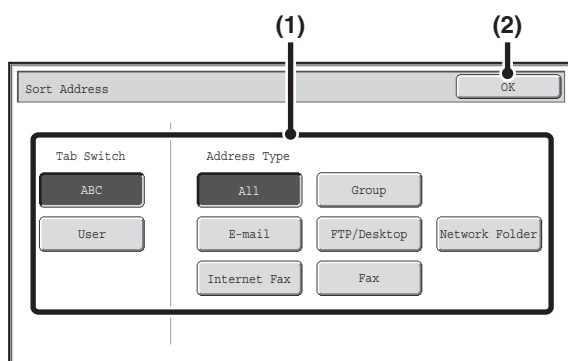

Change the display mode.

(1) Touch the key of the mode or tab that you wish to display.

- To show only the one-touch keys of a particular send mode, touch the desired mode key under "Address Type".
- To change the index tabs to the custom indexes, touch the [User] key under "Tab Switch".

(2) Touch the [OK] key.

## Index display

Indexes make it easy to search for a destination (one-touch key). The destinations are displayed separately using alphabetical search characters and index numbers. To display a stored destination, touch the appropriate index tab. It is convenient to store frequently used destinations in the [Freq.] index. Specify that a destination be displayed in the [Freq.] index when you store the destination.

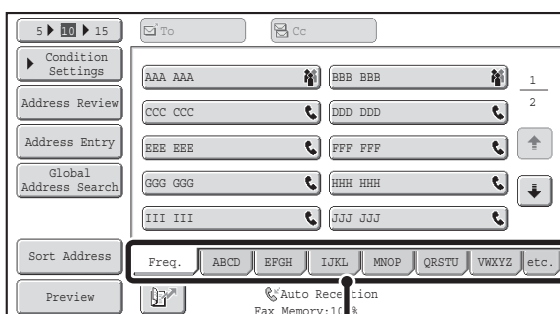

Index tabs

The destinations can be displayed in alphabetical order by their initials.

Each time the displayed index tab is touched, the display order changes in the following order: search numbers (page 4-21), ascending names, descending names, search numbers... When the display order is changed, the display order of the other index tabs also changes.

Ordered by search number (default)



Ascending names



Descending names



Index names can be changed using "Custom Index" in the system settings, allowing you to create groups of one-touch keys that can be easily recognized.



### System Settings: [Storing group keys \(page 7-18\)](#)

This is used to store custom index names. The custom index where a one-touch key appears is specified when the transmission destination is stored in the key.

### Narrowing the search letter range

An alphabet tab on an index tab can be touched to display keys to further narrow the search range. For example, when the [ABCD] tab is touched, keys from "A" to "D" appear. If the [B] key is touched, only destinations starting with the letter "B" will appear. To cancel, touch the key again. Note that the search letter range cannot be narrowed on the [Freq.] tab, the [etc.] tab, or on a user index tab.

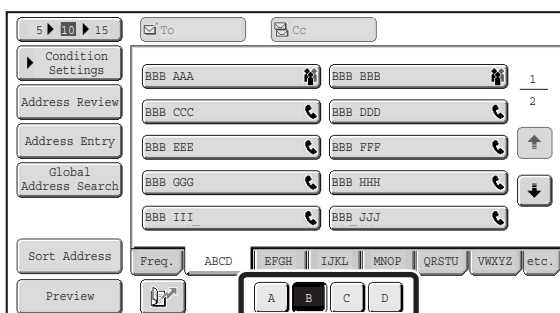

# FAX TRANSMISSION SEQUENCE

This section explains the basic procedure for sending a fax.

## Place the original.

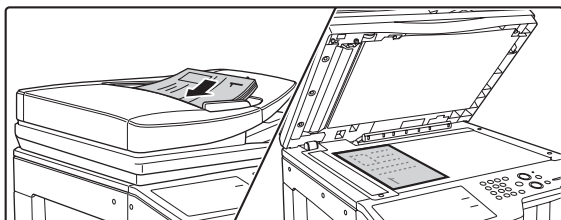

Place the original in the document feeder tray of the automatic document feeder, or on the document glass.



## Enter the destination fax number

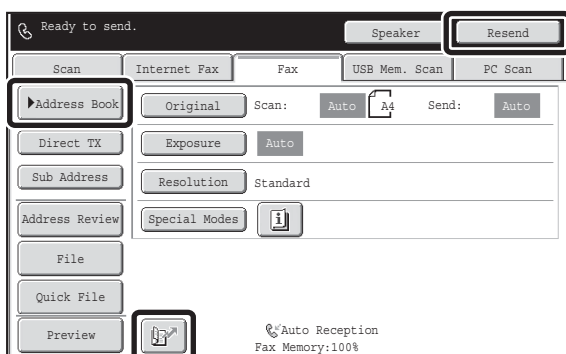

or

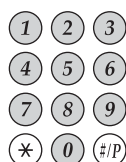

- [Address Book] key: Select a destination that is stored in the address book or look up a destination in a global address book.
  - [RETRIEVING A FAX NUMBER FROM THE ADDRESS BOOK](#) (page 4-18)
-  key: Use a search number to specify a destination stored in the address book.
  - [USING A SEARCH NUMBER TO RETRIEVE A DESTINATION](#) (page 4-21)
- [Resend] key: Select a fax number from the last eight destinations used for transmission.
  - [USING THE RESEND FUNCTION](#) (page 4-24)
- Numeric keys: Enter a fax number.
  - [ENTERING A FAX NUMBER WITH THE NUMERIC KEYS](#) (page 4-17)



## Select image settings.

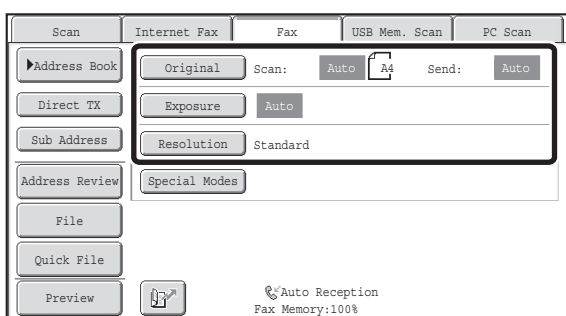

Select settings for the original to be faxed.

- [Original] key: Use this key to select the original size, the original send size, and 2-sided original scanning.
  - [SPECIFYING THE SCAN SIZE AND SEND SIZE \(Enlarge/Reduce\)](#) (page 4-48), [AUTOMATICALLY SCANNING BOTH SIDES OF AN ORIGINAL \(2-Sided Original\)](#) (page 4-47)
- [Exposure] key: Use this key to adjust the exposure of the image.
  - [CHANGING THE EXPOSURE](#) (page 4-55)
- [Resolution] key: Use this key to adjust the resolution of the image.
  - [CHANGING THE RESOLUTION](#) (page 4-56)



## Special mode settings

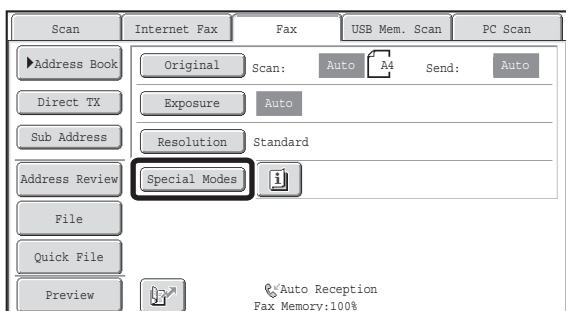

Touch the [Special Modes] key to select special modes such as timer transmission and the erase function.



## Begin transmission

Scan the original and send the fax.

If the original is placed on the document glass, follow these steps to start scanning and transmission:

### When sending a fax normally (memory transmission)

- (1) Press the [BLACK & WHITE START] key.
- (2) When scanning is finished, replace the original with the next original.
- (3) Press the [BLACK & WHITE START] key.
- (4) Repeat steps (2) and (3) until all originals have been scanned.
- (5) Touch the [Read-End] key.

### When sending a fax in direct transmission mode

Multiple originals cannot be scanned in direct transmission mode.

Press the [BLACK & WHITE START] key to start transmission.



When transmission ends, image settings and convenient special mode settings are cleared.



### To cancel scanning...

Press the [STOP] key (⏹).



### System Settings (Administrator): Default Display Settings

The settings can be kept in effect a fixed period of time after scanning is completed.



# ENTERING DESTINATIONS

This section explains how to enter destination fax numbers.

Destination fax numbers can be entered using the numeric keys, or by retrieving a previously stored fax number using the address book or a search number.

## ENTERING A FAX NUMBER WITH THE NUMERIC KEYS

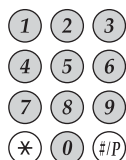

Enter the destination fax number with the numeric keys.



Take care to enter the correct number.



**If an incorrect number is entered...**

Press the [CLEAR] key (C) to clear the number and then enter the correct number.

## Entering a pause between digits of the number

Enter a pause after the number used to dial out from a PBX (for example, after "0"), or after the country code when dialling an international number.

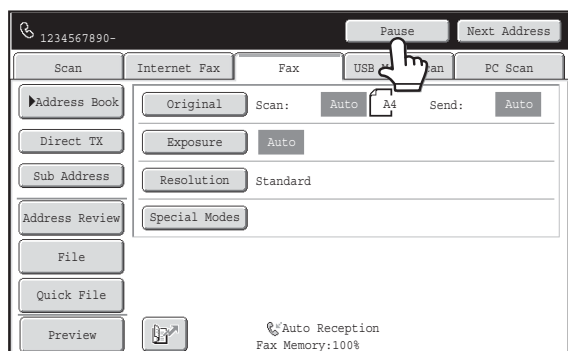

**Touch the [Pause] key.**

A hyphen "-" is entered when the [Pause] key is touched once.



**System Settings (Administrator): Pause Time Setting**

This is used to set the length of pauses. The default setting is 2 seconds.





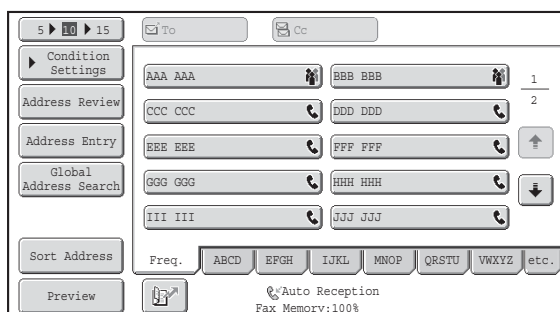

# RETRIEVING A FAX NUMBER FROM THE ADDRESS BOOK

The address book screen shows stored destinations as one-touch keys.

A destination fax number is retrieved by simply touching the one-touch key of that destination. This is called "one-touch dialling". It is also possible to store multiple fax numbers in a one-touch key, allowing you to retrieve all the numbers by simply touching the key. This is called "group dialling". This dialling method is convenient when you wish to send a fax to (or poll) multiple fax destinations.



When destinations of other scan modes are stored in addition to fax destinations, an icon indicating the mode appears together with the name of the destination in each one-touch key.

Icon	Mode
	Fax
	Scan to E-mail
	Internet fax (Direct SMTP)
	Scan to FTP
	Scan to Network Folder
	Scan to Desktop
	Group key with multiple destinations



## System Settings: [Address Book](#) (page 7-16)

This is used to store destinations (names and fax numbers) in the address book.

# RETRIEVING A STORED DESTINATION

A destination fax number is retrieved by simply touching the one-touch key of that destination.

1

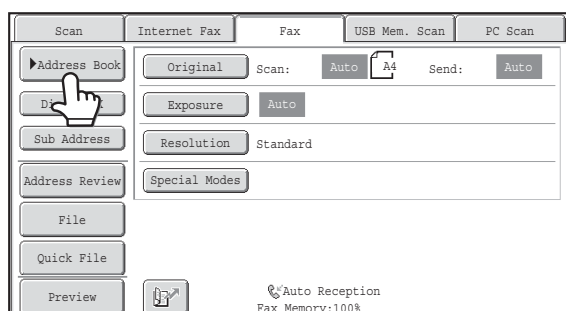

Touch the [Address Book] key.

2

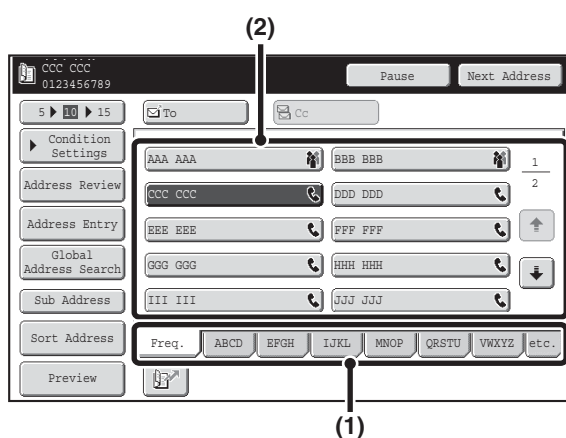

Select the destination.

- (1) Touch the index tab where the destination is stored.
- (2) Touch the one-touch key of the desired destination.

If you select an incorrect destination, touch the key again to cancel the selection.



- Frequently used destinations can be displayed in the [Freq.] index. Specify that a destination be displayed in the [Freq.] index when you store the destination.
- **To continue specifying other destinations...**  
Touch the [Next Address] key and repeat (1) and (2) of this step.



• **System Settings (Administrator): Must Input Next Address Key at Broadcast Setting**

This setting determines whether or not the [Next Address] key can be omitted before specifying the next destination. Factory default setting: The [Next Address] key can be omitted.

• **System Settings (Administrator): Disable Switching of Display Order**

This is used to disable switching of the order of display of the one-touch keys in the address book screen. The currently selected display order will be the order that is used after this setting is enabled.

# CHECKING AND DELETING ENTERED DESTINATIONS

When multiple destinations have been entered, you can display and check the destinations. You can also delete a destination (cancel selection of the destination).

1

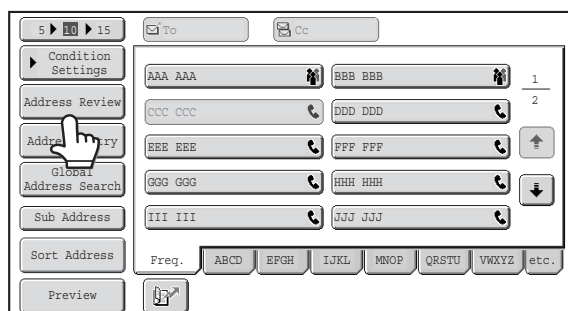

Touch the [Address Review] key.

2

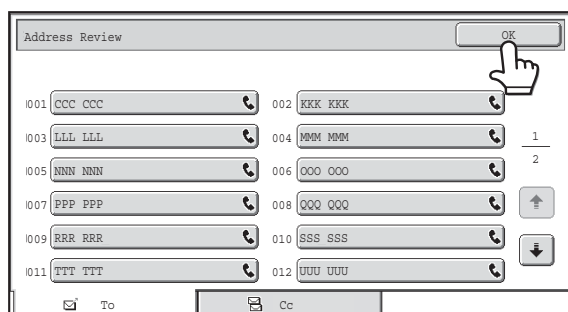

Check the destinations and then touch the [OK] key.



## To delete a destination...

Touch the one-touch key of the destination that you wish to delete. A message will appear to confirm the deletion. Touch the [Yes] key. Touch the [Detail] key to check the specified destination type and name.

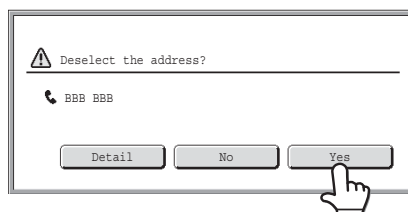

# USING A SEARCH NUMBER TO RETRIEVE A DESTINATION

A destination stored in the address book can be retrieved using the  key. This can be done in the base screen of any of the modes or in the address book screen.

1

Scan	Internet Fax	Fax	USB Mem. Scan	PC Scan
▶Address Book	Original	Scan: Auto	A4	Send: Auto
Direct TX	Exposure	Auto		
Sub Address	Resolution	Standard		
Address Review	Special Modes			
File				
Quick File				
Preview	 Auto Reception Fax Memory:100%			

**Touch the  key.**

2

1	2	3
4	5	6
7	8	9
*	0	#/P

**Enter the 4-digit search number of the address with the numeric keys.**

When the 4-digit search number is entered, the stored address is retrieved and specified as a destination.

---

2



- The search number is programmed when the destination is stored in the address book.
- If you do not know the search number, print the one-touch address list using "Sending Address List" in the system settings.
- When entering search numbers such as "0001" and "0011", "0" can be omitted. For example, to enter "0001", enter "1" and touch the  key or the [Next Address] key.

2



**If an incorrect search number is entered...**

Press the [CLEAR] key (C) to clear the number and enter the correct number.

# RETRIEVING A DESTINATION FROM A GLOBAL ADDRESS BOOK

If an LDAP server is stored in the Web pages, you can look up a destination fax number in a global address book.

1

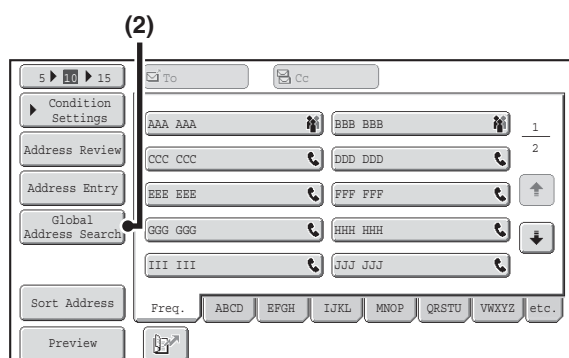

Open the global address search screen.

- (1) Touch the [Address Book] key in the base screen.
- (2) Touch the [Global Address Search] key.

2

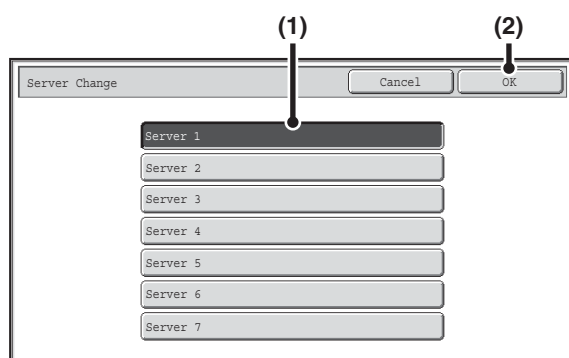

Search for the destination.

If only one LDAP server has been stored, (1) and (2) are not necessary. Go directly to (3). If an authentication screen for the LDAP server appears, enter your user name and password.

- (1) Touch the key of the LDAP server that you wish to use.
- If an authentication screen for the LDAP server appears, enter your user name and password.
- (2) Touch the [OK] key.
- (3) Search for the destination in the search screen.

Enter search characters for the destination and touch the [Search] key. The search results will appear after a brief interval.

For the procedure for entering text, see "[ENTERING TEXT](#)" (page 1-70) in "1. BEFORE USING THE MACHINE".



## How to search

Enter a maximum of 64 characters for the search characters. The system will look for names starting with the entered letters.

An asterisk \* can be used as follows:

XXX\*: Names beginning with "XXX".

\*XXX: Names that end with "XXX".

\*XXX\*: Names that include "XXX".

AA\*XX: Names that start with "AA" and end with "XX".

3

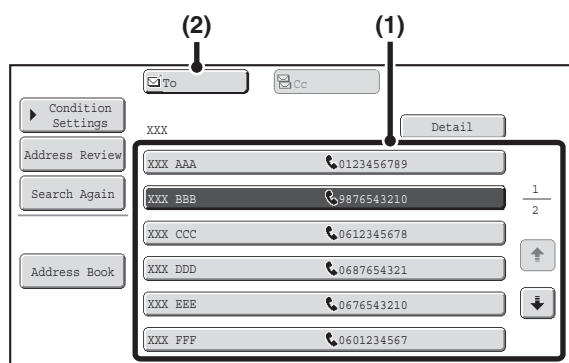

## Select the destination.

### (1) Touch the key of the desired destination.

If no names are found that match the search letters, a message will appear. Touch the [OK] key to close the message and touch the [Search Again] key to search again.

### (2) Touch the [To] key.

This enters the selected destination.

If you wish to select another destination, repeat steps (1) and (2) above.



- If 30 or more matches are found, a message will appear in the screen. Touch the [OK] key to close the message. A maximum of 300 search results are displayed. If the desired destination was not found, touch the [Search Again] key to add more search letters.
- **To check the information stored in a destination...**  
Touch the key of the destination and then touch the [Detail] key. The information stored for the selected destination will appear. Check the information and then touch the [OK] key to return to the search results screen.
- **If a screen for selecting the item to be used appears...**  
If the selected destination includes an E-mail address or other address in addition to the fax number or telephone number, you will need to select which item you wish to use. Touch the [Fax] key to retrieve the fax number.

## Storing a destination from a global address book in the machine's address book

A destination from a global address book can be stored in the machine's address book as a one-touch key. Touch the [Detail] key in the search results screen of the global address book (the screen of step 3 above) to display information on the selected destination. Touch the [Register] key in the detailed information screen and then touch the item to be used (the [Fax] key in this case). The following screen will appear.

The information stored in the global address book is automatically entered. (The settings can be changed if needed. For detailed information on each item, see "[Address Control](#)" (page 7-16) in "7. SYSTEM SETTINGS".) However, configure the items below manually. To complete the storing procedure, touch the [Exit] key.

- [Initial] key: Touch this key to enter the initials that determine where the destination will appear in the alphabetical index and the order of one-touch key display. Enter up to 10 characters for the initials.
- [Index] key: Touch this key to select the custom index in which the address will appear. You can also select whether or not the destination will be included on the [Freq.] tab of the address book.
- [Mode] key: Touch this key to configure the "Transmission Speed" and "International Correspondence Mode" settings. These settings have already been configured, however, if the destination is an international destination, or if you find that communication errors frequently occur when communicating with that destination, you can try changing the settings.

# USING THE RESEND FUNCTION

The destinations of the most recent 8 transmissions by fax, Scan to E-mail, and/or Internet fax are stored. One of these can be selected to resend to that destination.

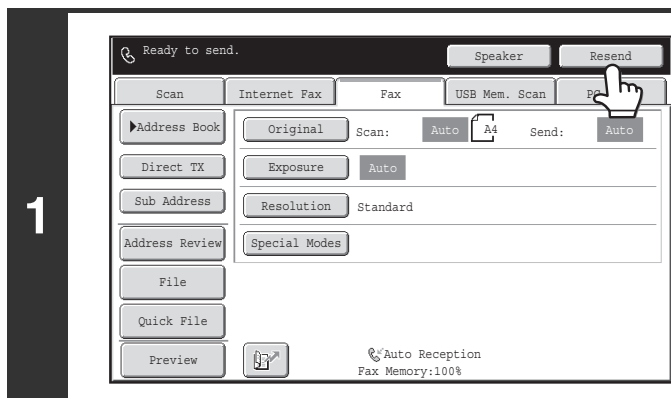

Touch the [Resend] key.

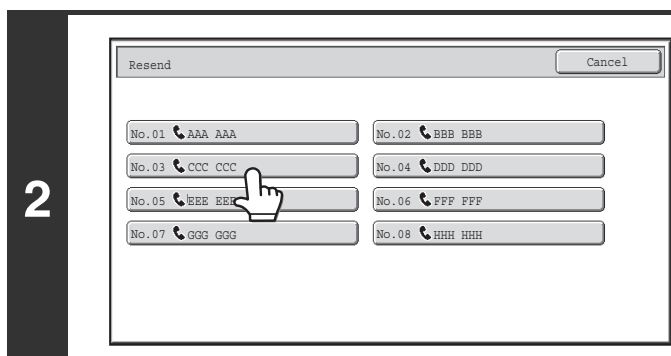

Touch the key of the fax destination that you wish to redial.

The last 8 transmission destinations appear.



- If numeric keys were pressed during the previous transmission, the [Resend] key may not dial the correct number.
- The fax addresses below are not stored as addresses for which resend is possible.
  - A one-touch key in which multiple destinations are stored (group key).
  - Broadcast destinations
  - Destinations transmitted to using a program



#### System Settings (Administrator): Disable [Resend] on Fax/Image Send Mode

This prohibits use of the resend function. When this setting is enabled, the [Resend] key cannot be used in the base screen of image send mode.



# CHAIN DIALLING

Number sequences entered with the numeric keys and/or one-touch keys can be linked together with pauses and dialled as a single number.

Use chain dialling to dial a long number (such as an international number) when the country code and/or area code are stored separately in one-touch keys.

## Example: Using chain dialling to dial an international number

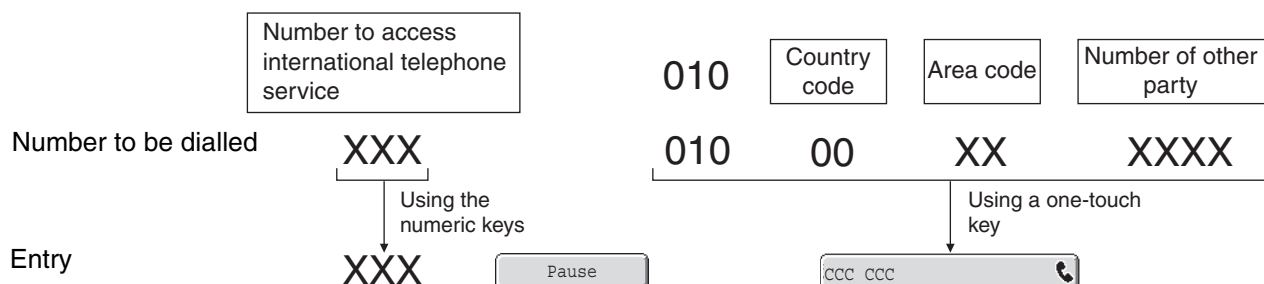

### System Settings (Administrator): Pause Time Setting

This is used to set the length of pauses. The default setting is 2 seconds.

# BASIC TRANSMISSION METHODS

This section explains the basic procedures for sending a fax.

## TRANSMISSION METHODS

The methods that can be used to send a fax from the machine are explained below. Select the method that best suits your needs.

### To fax a large number of sheet originals, use the automatic document feeder.

The originals will be scanned into memory and then transmitted (memory transmission).

When memory transmission is selected and multiple originals are placed in the automatic document feeder (and the line is free), transmission will begin as soon as the first page is scanned and will take place while the remaining pages are being scanned (Quick Online transmission).

If transmission cannot begin immediately because the line is in use, all pages will be scanned into memory and the transmission will be reserved.

☞ [USING THE AUTOMATIC DOCUMENT FEEDER FOR TRANSMISSION](#) (page 4-32)

When a fax transmission or reception is already in progress, the following procedure can be performed to reserve a transmission job. To check reserved transmission jobs, display the job status screen.

☞ [CHECKING THE STATUS OF FAX JOBS](#) (page 4-128)

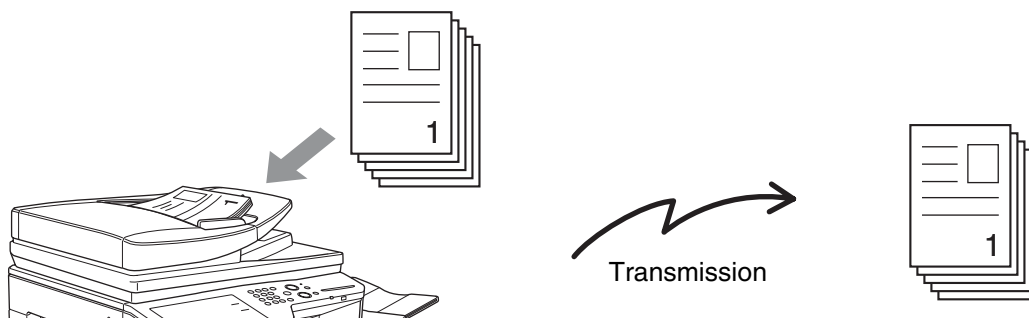

- If memory becomes full while the first original page is being scanned, transmission will stop.
- In the following situations, the transmission will be automatically reserved (memory transmission)
  - When the line is busy or a communication error occurs and automatic resending is enabled.
    - ☞ [WHEN THE LINE IS BUSY](#) (page 4-30), [WHEN A COMMUNICATION ERROR OCCURS](#) (page 4-30)
  - The machine is already using the line to send or receive a fax.
  - Another fax transmission was reserved ahead of your fax.
  - One of the following functions is being used for transmission.
    - Broadcast transmission, F-code transmission, timer transmission, Dual Page Scan, 2in1, Card Shot, Job Build, Original Count
  - The document glass is being used (except when the speaker is being used to dial).
- Up to 94 transmission jobs can be reserved.
- When the transmission is finished, the scanned original pages are cleared from memory. However, when the document filing function is used, the transmitted fax is stored.



#### System Settings (Administrator): Quick On Line Sending

This is used to disable Quick Online transmission. In this case, fax transmissions will be sent by memory transmission (reserved and then transmitted).

## To fax thick originals or pages of a book, use the document glass.

 [USING THE DOCUMENT GLASS FOR TRANSMISSION](#) (page 4-35)

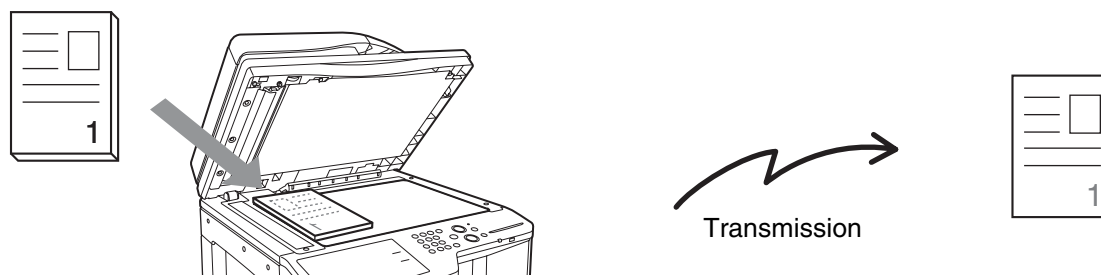

When the document glass is being used for a transmission, Quick Online transmission will not operate.

## If you wish to send a fax ahead of other previously reserved fax transmissions, use direct transmission mode.

The original is transmitted directly to the receiving fax machine without being scanned into memory.

When direct transmission mode is used, transmission will begin as soon as the transmission in progress is completed (ahead of any previously reserved transmissions).

To send a fax by direct transmission, touch the [Direct TX] key in the base screen.

 [USING THE AUTOMATIC DOCUMENT FEEDER TO SEND A FAX IN DIRECT TRANSMISSION MODE](#) (page 4-33)

 [USING THE DOCUMENT GLASS TO SEND A FAX IN DIRECT TRANSMISSION MODE](#) (page 4-37)

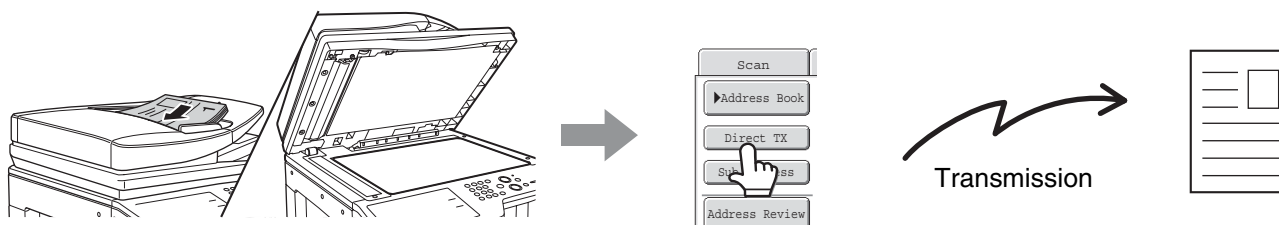

- When transmission in direct transmission mode ends, the mode automatically changes back to memory transmission mode.
- When the document glass is used, multiple original pages cannot be scanned.

## PLACEMENT ORIENTATION OF THE ORIGINAL

When an A4 (8-1/2" x 11") original is placed in vertical orientation (⏏), the image is automatically rotated 90 degrees and transmitted in horizontal orientation (⏏) (Rotation Sending). If the original is placed in horizontal orientation (⏏), it is transmitted in that orientation (⏏) without being rotated.

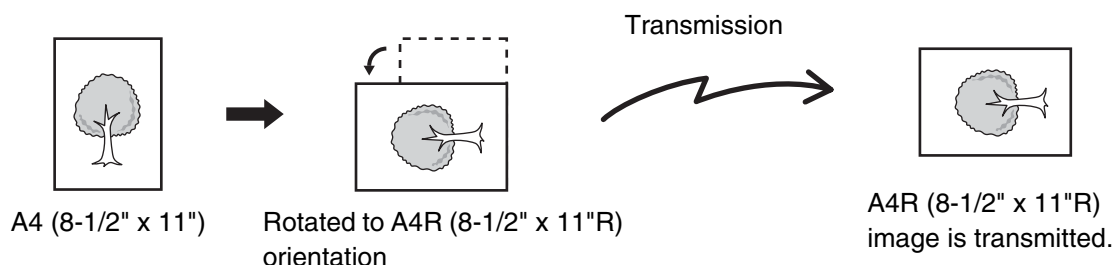

A4R, B5 and A5 (8-1/2" x 11"R and 5-1/2" x 8-1/2") size originals are not rotated for transmission.



### System Settings (Administrator): Rotation Sending Setting

The factory default setting is rotate before transmission. If this setting is disabled, the original will be transmitted in the orientation in which it is placed.

## AUTOMATIC REDUCTION OF THE TRANSMITTED IMAGE

If the width of the transmitted image is larger than the width of the paper in the receiving machine, the image will be automatically reduced to fit the receiving machine's paper width.

### Example: Reduced sizes and reduction ratios

Transmitted image width	Receiving machine's paper width	Reduced size	Ratio
A3	B4	B4	1 : 0.84
A3 (11" x 17")	A4 (8-1/2" x 14", 8-1/2" x 11")	A4R (8-1/2" x 14", 8-1/2" x 11"R)	1 : 0.71
B4	A4	A4R	1 : 0.84



### System Settings (Administrator): Auto Reduction Sending Setting

The factory default setting is automatic reduction enabled. If this setting is disabled, the image will be sent at full size and part of the image may be cut off.

## TRANSMITTABLE ORIGINAL SIZES

The following original sizes can be transmitted.

	Minimum original size	Maximum original size
Using the automatic document feeder	131 mm (height) x 140 mm (width) (5-1/8" (height) x 5-1/2" (width))	297 mm (height) x 1000 mm* (width) (11-5/8" (height) x 39-3/8"* (width))
Using the document glass	–	297 mm (height) x 432 mm (width) (11-5/8" (height) x 17" (width))

\*A long original can be transmitted.

## THE SIZE OF THE PLACED ORIGINAL

When a standard size original is placed, the original size is automatically detected and displayed in "Scan" in the base screen.

When the automatic original detection function is operating and the original is a non-standard size, the closest standard size may be displayed or the original size may not appear. In this event, manually set the correct original size.

 [Specifying the original scan size \(by paper size\)](#) (page 4-49)

 [Specifying the original scan size \(by numerical values\)](#) (page 4-51)

## STANDARD SIZES

Standard sizes are sizes that the machine can automatically detect. The standard sizes are set in "Original Size Detector Setting" in the system settings (administrator).

### List of original size detector settings

Selections	Standard sizes (detected original sizes)	
	Document glass	Document feeder tray (automatic document feeder)
AB-1	A3, A4, A4R, A5, B4, B5, B5R	A3, A4, A4R, A5, B4, B5, B5R, 8-1/2" x 11", 8-1/2" x 14", 11" x 17"
AB-2	A3, A4, A4R, A5, B5, B5R, 216 mm x 330 mm (8-1/2" x 13")	A3, A4, A4R, A5, B4, B5, B5R, 8-1/2" x 11", 11" x 17", 216 mm x 330 mm (8-1/2" x 13")
AB-3	A4, A4R, A5, B4, 8K, 16K, 16KR	A3, A4, A4R, A5, B4, 8K, 16K, 16KR, 8-1/2" x 11", 11" x 17", 216 mm x 330 mm (8-1/2" x 13")
AB-4	A3, A4, A4R, A5, B5, B5R, 216 mm x 340 mm (8-1/2" x 13-2/5")	A3, A4, A4R, A5, B4, B5, B5R, 8-1/2" x 11", 11" x 17", 216 mm x 340 mm (8-1/2" x 13-2/5")
AB-5	A3, A4, A4R, A5, B5, B5R, 216 mm x 343 mm (8-1/2" x 13-1/2")	A3, A4, A4R, A5, B4, B5, B5R, 8-1/2" x 11", 11" x 17", 216 mm x 343 mm (8-1/2" x 13-1/2")
Inch-1	11" x 17", 8-1/2" x 14", 8-1/2" x 11", 8-1/2" x 11"R, 5-1/2" x 8-1/2"	11" x 17", 8-1/2" x 14", 8-1/2" x 11", 8-1/2" x 11"R, 5-1/2" x 8-1/2", A4, A3
Inch-2	11" x 17", 8-1/2" x 13" (216 mm x 330 mm), 8-1/2" x 11", 8-1/2" x 11"R, 5-1/2" x 8-1/2"	11" x 17", 8-1/2" x 13" (216 mm x 330 mm), 8-1/2" x 11", 8-1/2" x 11"R, 5-1/2" x 8-1/2", A4, A3
Inch-3	11" x 17", 8-1/2" x 13-2/5" (216 mm x 340 mm), 8-1/2" x 11", 8-1/2" x 11"R, 5-1/2" x 8-1/2"	11" x 17", 8-1/2" x 13-2/5" (216 mm x 340 mm), 8-1/2" x 11", 8-1/2" x 11"R, 5-1/2" x 8-1/2", A4, A3

## WHEN THE LINE IS BUSY

If the line is busy when you send a fax, transmission will be re-attempted automatically after a preset interval. This function only operates in memory transmission mode. In direct transmission mode or manual transmission mode, the transmission will be cancelled. Wait briefly and then try sending the fax again.

**To cancel transmission...**

Cancel the transmission from the job status screen.

 [CANCELLING A FAX IN PROGRESS OR A RESERVED FAX](#) (page 4-135)

**System Settings (Administrator): Recall in Case of Line Busy**

This is used to set the number of recall attempts and the interval between attempts when the connection cannot be established because the line is busy.

## WHEN A COMMUNICATION ERROR OCCURS

If a communication error occurs or the other fax machine does not answer the call within a preset period of time, transmission will be re-attempted automatically after a preset interval. This function only operates in memory transmission mode.

**To cancel transmission...**

Cancel the transmission from the job status screen.

 [CANCELLING A FAX IN PROGRESS OR A RESERVED FAX](#) (page 4-135)

**System Settings (Administrator): Recall in Case of Communication Error**

This is used to set the number of recall attempts and the interval between attempts when a transmission fails due to an error.

# FAX DESTINATION CONFIRMATION MODE

The fax destination confirmation mode displays a destination confirmation message when a fax transmission is performed to prevent accidental transmission to the wrong destination. This function is enabled in the system settings (administrator). When the function is enabled, a message will appear to confirm the destination when the [BLACK & WHITE START] key is pressed to begin fax transmission.

The message that appears will vary depending on the method used to specify the destination.

## Destination specified by one-touch key/search number

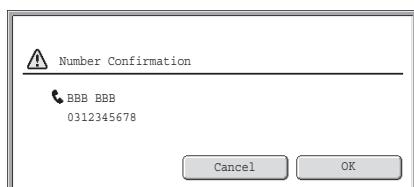

Make sure that the destination indicated in the message is correct and touch the [OK] key. Scanning will begin. If the destination is not correct, touch the [Cancel] key and select the destination again.

## Destination specified by the numeric keys, [Resend] key, or [Global Address Search] key

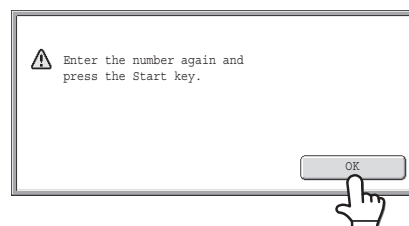

Touch the [OK] key, re-enter the destination with the numeric keys, and press the [BLACK & WHITE START] key.

If the re-entered destination is correct, scanning will begin.

If the re-entered destination is not correct, a message will appear. Touch the [OK] key and re-enter the destination. If an incorrect number is entered for confirmation 3 times in a row, the screen will revert to the base screen.

- If the [Sub Address] key was used to enter a sub-address and passcode, the fax number must be re-entered during confirmation. After re-entering the fax number, touch the [Sub Address] key and enter the sub-address and passcode.
- If chain dialling was used, touch the [Pause] key to enter "-" during confirmation.

## Functions that cannot be used

When the fax destination confirmation function is enabled, only one destination is allowed, and thus the following functions cannot be used.

### • Broadcast transmission to multiple destinations including fax destinations

Group keys and program keys that contain multiple fax destinations cannot be used. After one destination is specified, keys such as another one-touch key, the [Next Address] key, the [Address Entry] key, and the [Global Address Search] key cannot be touched.

### • Transmission using the speaker key

A destination cannot be specified after the [Speaker] key is pressed.



### System Settings (Administrator): Fax Dest. Confirmation Mode

This setting is used to have a destination confirmation message appear when a fax is sent.

# USING THE AUTOMATIC DOCUMENT FEEDER FOR TRANSMISSION

This section explains how to use the automatic document feeder to send a fax.

1

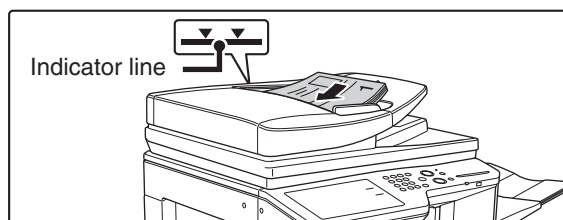

**Place the originals face up in the document feeder tray with the edges aligned evenly.**

Insert the originals all the way into the document feeder tray. Multiple originals can be placed in the document feeder tray. The stack of originals must not be higher than the indicator line on the tray.



When sending a multi-page fax, the automatic document feeder and the document glass cannot both be used to scan the original pages.

2

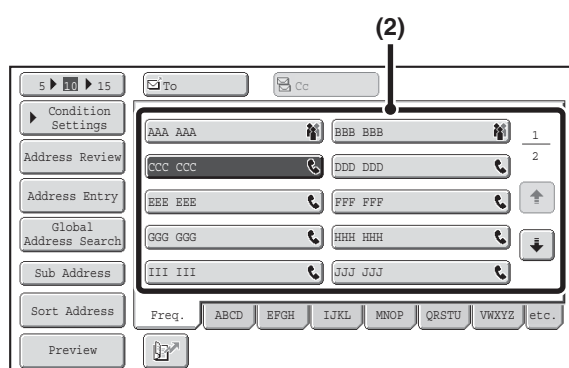

**Enter the destination fax number.**

(1) Touch the [Address Book] key in the base screen.

(2) Touch the one-touch key of the desired destination.



In addition to specification by one-touch key, a destination can also be specified using a search number. You can also directly enter a fax number with the numeric keys or look up a destination in a global address book. For more information, see ["ENTERING DESTINATIONS"](#) (page 4-17).

3

**Press the [BLACK & WHITE START] key.**

Scanning begins.

When scanning is completed, the machine sounds a beep.



When scanning is completed, "Job stored." will be displayed together with a job control number. This number can be used to locate the job in the Transaction Report or in the Image Sending Activity Report.

- If a fax is being received when the transmission operation is performed, the transmission will be reserved and transmitted after fax reception is completed.
- If the memory becomes full while the originals are being scanned, a message will appear and scanning will stop. If Quick Online transmission is taking place, the originals that were scanned will be transmitted. If Quick Online is not enabled, the transmission will be cancelled.



#### System Settings (Administrator): Scan Complete Sound Setting

The scan complete sound can be selected.



#### To cancel scanning...

Press the [STOP] key (⏹) to cancel the operation.



# USING THE AUTOMATIC DOCUMENT FEEDER TO SEND A FAX IN DIRECT TRANSMISSION MODE

1

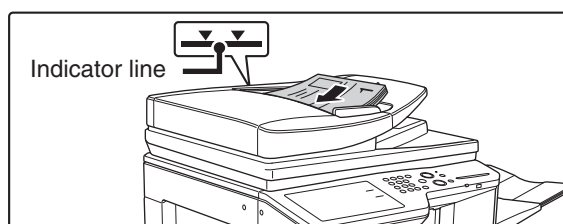

Place the originals face up in the document feeder tray with the edges aligned evenly.

Insert the originals all the way into the document feeder tray. Multiple originals can be placed in the document feeder tray. The stack of originals must not be higher than the indicator line on the tray.

2

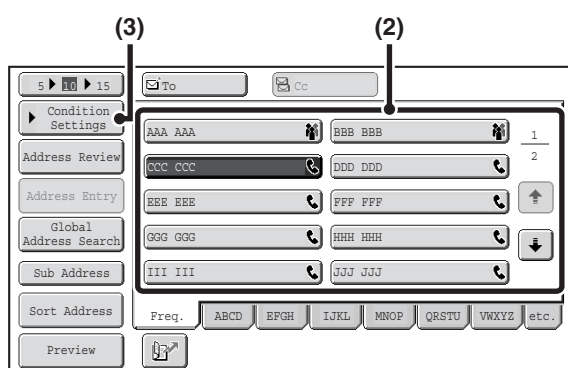

Enter the destination fax number.

- (1) Touch the [Address Book] key in the base screen.
- (2) Touch the one-touch key of the desired destination.
- (3) Touch the [Condition Settings] key.



- Only one destination can be entered. A one-touch key in which multiple destinations are stored (group key) cannot be used.
- In addition to specification by one-touch key, a destination can also be specified using a search number. You can also directly enter a fax number with the numeric keys or look up a destination in a global address book. For more information, see "[ENTERING DESTINATIONS](#)" (page 4-17).

3

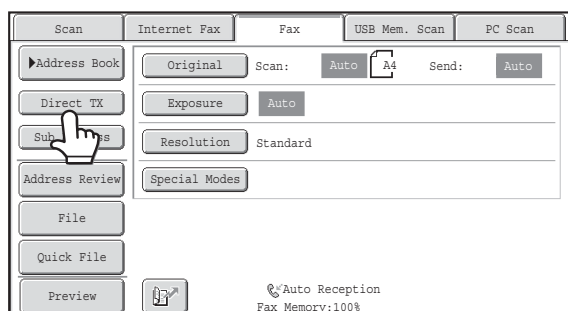

Touch the [Direct TX] key.

4

Press the [BLACK & WHITE START] key.



Transmission begins.



To cancel transmission...

While "Dialling. Press [⏏] to cancel." appears or while the fax is being transmitted, press the [STOP] key (⏏).



- The following functions cannot be used with direct transmission:  
Program, Timer Transmission, 2in1, Card Shot, Job Build, Polling Memory, Original Count, File, Quick File, Memory Box, 2-Sided Original Scanning, Global Address Search
  - Resending will not take place when a direct transmission is not successful due to a communication error or other reason.
  - If a fax transmission is already in progress when the direct transmission operation is performed, the direct transmission will wait until the previous transmission is finished. When the previous transmission is completed, the direct transmission will begin. While the direct transmission is waiting, the [JOB STATUS] key (  ) can be touched to display the job status screen. No other operations are possible.
-  [CHECKING THE STATUS OF FAX JOBS](#) (page 4-128)

# USING THE DOCUMENT GLASS FOR TRANSMISSION

To fax a thick original or other original that cannot be fed through the automatic document feeder, open the automatic document feeder and place the original on the document glass.

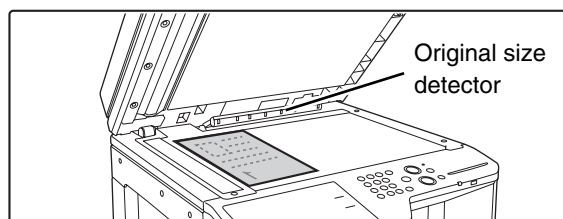

Open the automatic document feeder, place the original face down on the document glass, and then gently close the automatic document feeder.

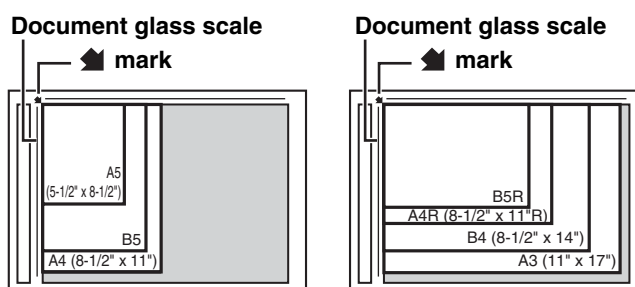

- Align the corner of the original with the tip of the arrow mark  on the document glass scale.
- Place the original in the appropriate position for its size as shown above.

1



Do not place any objects under the original size detector. Closing the automatic document feeder with an object underneath may damage the original size detector plate and prevent correct detection of the document size.



- When faxing a multi-page original, scan each page in order starting from the first page.
- When sending a multi-page fax, the automatic document feeder and the document glass cannot both be used to scan the original pages.

2

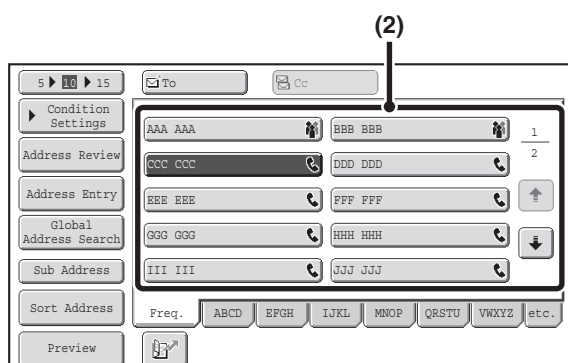

Enter the destination fax number.

- (1) Touch the [Address Book] key in the base screen.
- (2) Touch the one-touch key of the desired destination.



In addition to specification by one-touch key, a destination can also be specified using a search number. You can also directly enter a fax number with the numeric keys or look up a destination in a global address book. For more information, see "[ENTERING DESTINATIONS](#)" (page 4-17).

3

**Press the [BLACK & WHITE START] key.**

Scanning begins.

4

**If you have another page to scan, change pages and then press the [BLACK & WHITE START] key.**

Repeat until all originals have been scanned.



If no action is taken for one minute, scanning automatically ends and the transmission is reserved.

5



- When scanning is completed, "Job stored." will be displayed together with a job control number. This number can be used to locate the job in the Transaction Report or in the Image Sending Activity Report.
- If no action is taken for one minute after the confirmation screen appears, scanning automatically ends and the transmission is reserved.
- The [Configure] key can be touched to change the exposure, resolution, scan size, and send size for each original page scanned. However, when "2in1" or "Card Shot" is selected in the special modes, only the exposure can be changed, and this can only be done when scanning each even page number of the original pages.

**To cancel transmission...**

Press the [STOP] key (⏹) before the [Read-End] key is touched.

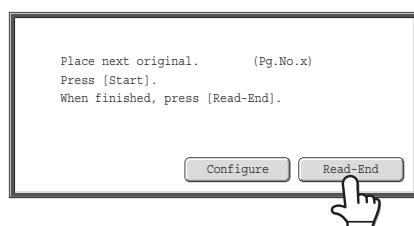
**Touch the [Read-End] key.**

A beep sounds.

Open the automatic document feeder and remove the original.



- If a fax is being received when the transmission operation is performed, the transmission will be reserved and transmission will take place after fax reception is completed.
- If the memory becomes full while the originals are being scanned, a message will appear and transmission will be cancelled.

# USING THE DOCUMENT GLASS TO SEND A FAX IN DIRECT TRANSMISSION MODE

When sending a fax from the document glass in direct transmission mode, only one page can be transmitted.

1

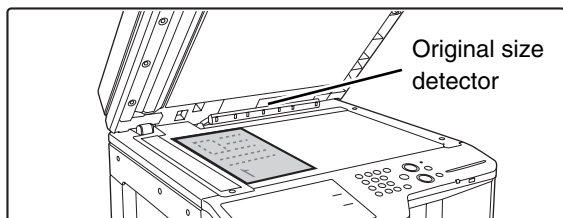

Open the automatic document feeder, place the original face down on the document glass, and then gently close the automatic document feeder.

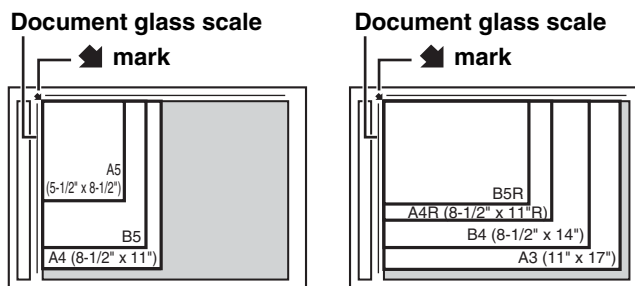

- Align the corner of the original with the tip of the arrow mark  on the document glass scale.
- Place the original in the appropriate position for its size as shown above.



Do not place any objects under the original size detector. Closing the automatic document feeder with an object underneath may damage the original size detector plate and prevent correct detection of the document size.

2

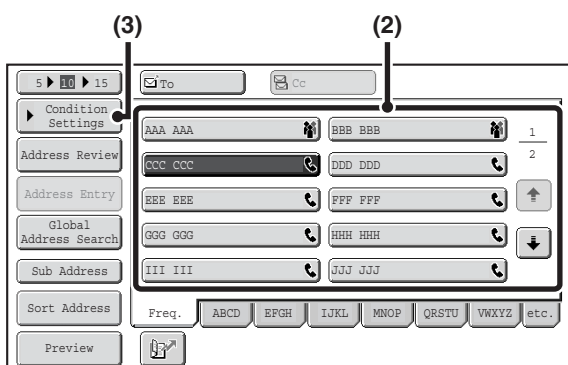

Enter the destination fax number.

- (1) Touch the [Address Book] key in the base screen.
- (2) Touch the one-touch key of the desired destination.
- (3) Touch the [Condition Settings] key.



- Only one destination can be entered. A one-touch key in which multiple destinations are stored (group key) cannot be used.
- In addition to specification by one-touch key, a destination can also be specified using a search number. You can also directly enter a fax number with the numeric keys or look up a destination in a global address book. For more information, see "[ENTERING DESTINATIONS](#)" (page 4-17).

3

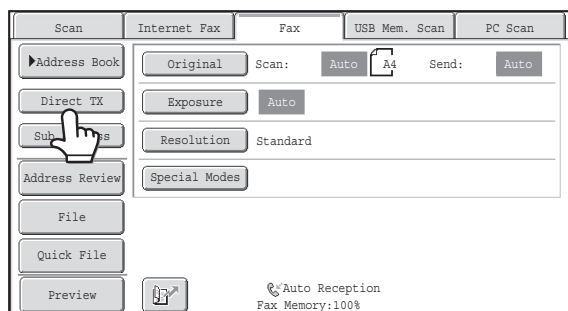

Touch the [Direct TX] key.

4

Press the [BLACK & WHITE START] key.

Transmission begins.



**To cancel transmission...**

While "Dialling. Press [STOP] to cancel" appears in the display, press the [STOP] key (⏏).



- The following functions cannot be used with direct transmission:  
Program, Timer Transmission, 2in1, Card Shot, Job Build, Polling Memory, Original Count, File, Quick File, Memory Box, 2-Sided Original Scanning, Global Address Search
  - Resending will not take place when a direct transmission is not successful due to a communication error or other reason.
  - If a fax transmission is already in progress when the direct transmission operation is performed, the direct transmission will wait until the previous transmission is finished. When the previous transmission is completed, the direct transmission will begin. While the direct transmission is waiting, the [JOB STATUS] key (⏏) can be touched to display the job status screen. No other operations are possible.
- 👉 [CHECKING THE STATUS OF FAX JOBS](#) (page 4-128)

# TRANSMISSION USING THE SPEAKER

When the speaker is used to dial, the fax is sent after the number is dialed and the connection is established. If a person answers, you will be able to hear his or her voice, but you will not be able to speak.

1

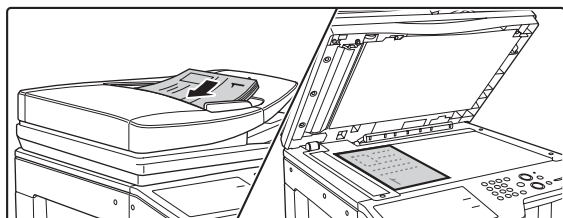

## Place the original.

Place the original face up in the document feeder tray, or face down on the document glass.

When the document glass is used, only one page can be transmitted.

2

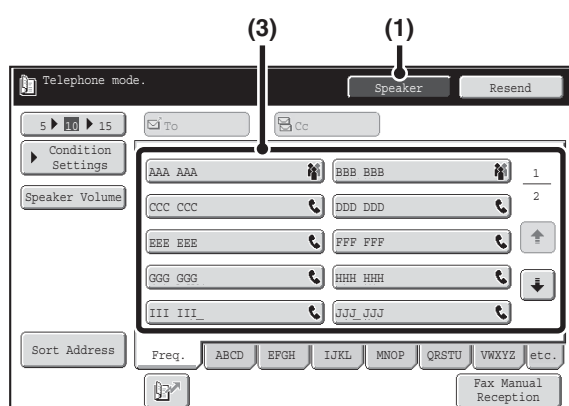

## Enter the destination fax number.

### (1) Touch the [Speaker] key.

You will hear the dial tone through the machine's speaker.

### (2) Touch the [Address Book] key in the base screen.

### (3) Touch the one-touch key of the desired destination.

A group key cannot be used.



- In addition to specification by one-touch key, a destination can also be specified using a search number. You can also directly enter a fax number with the numeric keys or look up a destination in a global address book. For more information, see "[ENTERING DESTINATIONS](#)" (page 4-17).
- After touching the [Speaker] key, you can touch the [Speaker Volume] key to adjust the volume of the speaker. The speaker volume changes each time the [Speaker Volume] key is touched. Adjust the volume to the desired level.

3

## Wait until the connection is made and then press the [BLACK & WHITE START] key.

Transmission begins.



### To cancel transmission...

Touch the [Speaker] key before the [BLACK & WHITE START] key is pressed. The line will be disconnected and transmission will stop.



- When the speaker is used, transmission takes place without scanning the original into memory.
- A destination that includes an F-code (sub-address and passcode) cannot be used.
- A one-touch key that has multiple destinations or has a non-fax destination cannot be used.



### System Settings (Administrator): Speaker Settings

The default volume level of the speaker can be changed in the "Speaker Settings".

# SENDING THE SAME FAX TO MULTIPLE DESTINATIONS (Broadcast Transmission)

This function is convenient when you need to send the same fax to multiple destinations, such as sending a report to branch offices in different regions. A single broadcast operation allows transmissions to a maximum of 500 destinations.

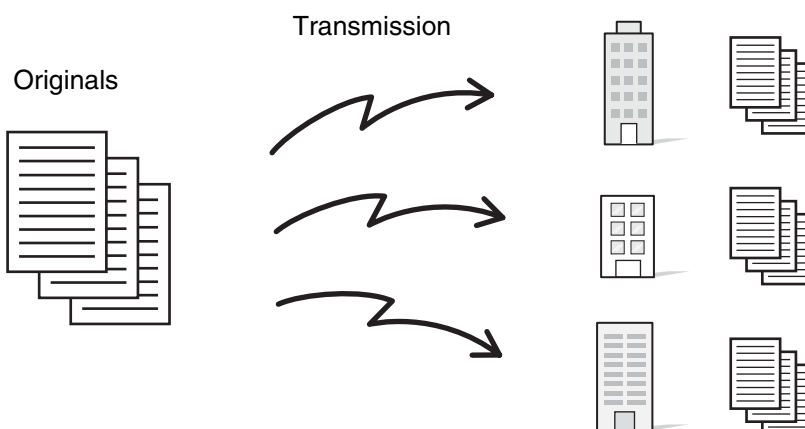

It is convenient to store destinations to which you frequently send faxes by broadcast transmission in group keys. Group dialling allows you to retrieve multiple fax numbers stored in a one-touch key by simply pressing the one-touch key. To store group keys, see "[Address Control](#)" (page 7-16) in "7. SYSTEM SETTINGS".

When a group key is used to dial, the number of fax numbers that are dialled is the number of destinations that are stored in the group key. When a group key that has 10 destinations is used, 10 fax numbers are dialled.

1

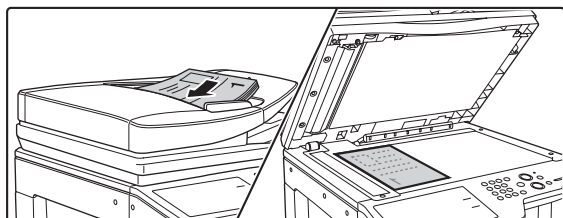

## Place the original.

Place the original face up in the document feeder tray, or face down on the document glass.



2

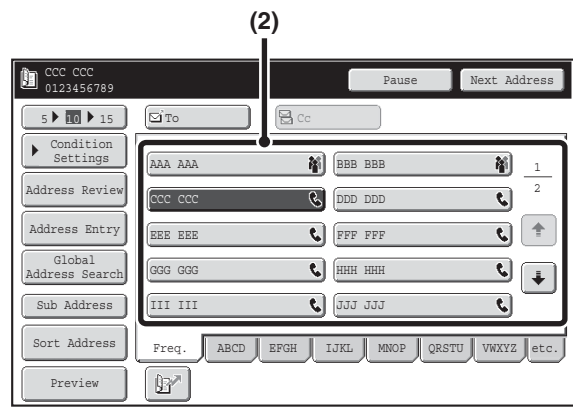

### Enter the destination fax number.

- (1) Touch the [Address Book] key in the base screen.
- (2) Touch the one-touch key of the desired destination.
- (3) Repeat step (2) until all destinations are selected.



- In addition to specification by one-touch key, a destination can also be specified using a search number. You can also directly enter a fax number with the numeric keys or look up a destination in a global address book. For more information, see "ENTERING DESTINATIONS" (page 4-17).
- It is convenient to use a group key to enter the destinations.
- After entering a destination with the numeric keys, if you wish to enter another destination with the numeric keys, touch the [Next Address] key before entering the next destination. The [Next Address] key can be omitted before or after a destination entered using a one-touch key. However, if "Must Input Next Address Key at Broadcast Setting" is enabled in the system settings (administrator), the [Next Address] key must be touched before entering the next destination.

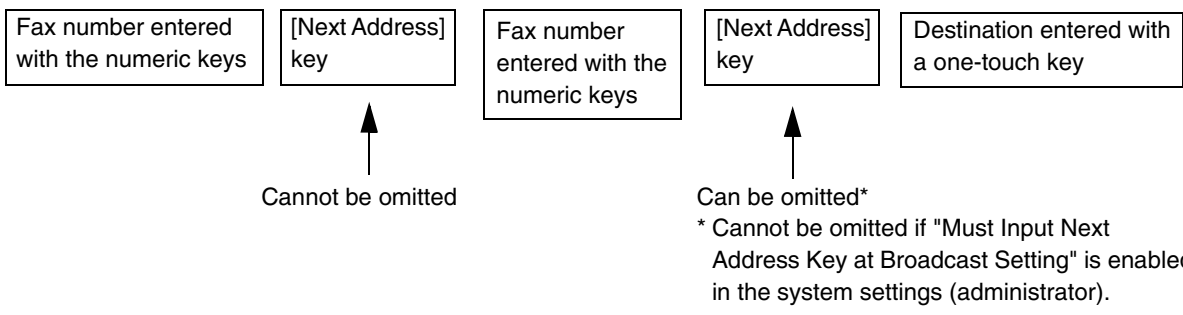

### System Settings (Administrator): Must Input Next Address Key at Broadcast Setting

This setting is used to prohibit omission of the [Next Address] key when entering destinations for broadcast transmissions.

3

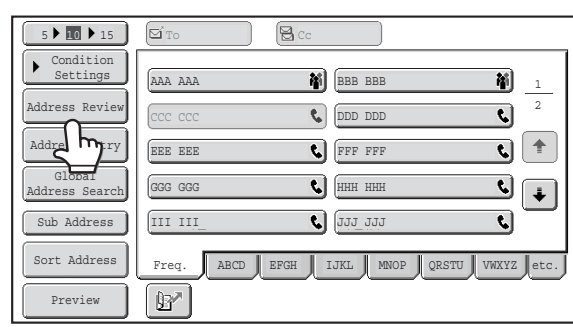

### Touch the [Address Review] key.

4

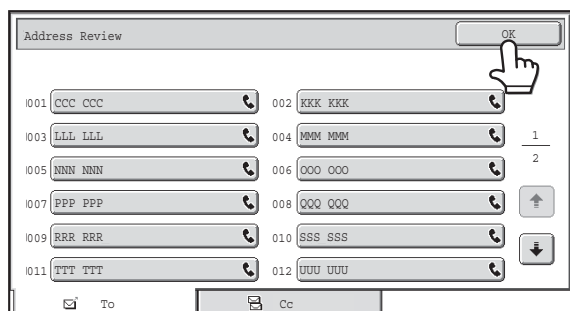

Check the destinations and then touch the [OK] key.



#### To cancel a specified destination...

Touch the key of the destination that you wish to cancel. A message will appear to confirm the deletion. Touch the [Yes] key.

 [CHECKING AND DELETING ENTERED DESTINATIONS](#) (page 4-20)

5

### Press the [BLACK & WHITE START] key.

Scanning begins.

- If you inserted the original pages in the document feeder tray, all pages are scanned. A beep will sound to indicate that scanning is finished.
- If you are scanning the original on the document glass, scan each page one page at a time. When scanning finishes, place the next original and press the [BLACK & WHITE START] key. Repeat until all pages have been scanned and then touch the [Read-End] key. A beep will sound to indicate that scanning is finished.



#### To cancel scanning...

Press the [STOP] key (  ).



- A broadcast transmission takes place by memory transmission only.
- A broadcast transmission can be used in combination with the timer transmission function to transmit at night or any other desired time. A broadcast transmission can also be used in combination with other convenient functions.
- The broadcast transmission can include Scan to E-mail and Internet fax destinations. In this case, the image sent to the Scan to E-mail and Internet fax destinations will be black and white.

## Resending to unsuccessful broadcast transmission destinations

The results of a completed broadcast transmission can be checked in the job status screen. If transmission to any of the destinations failed, resend the fax to those destinations.

1

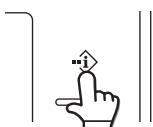

Touch the [JOB STATUS] key (Ⓜ).

2

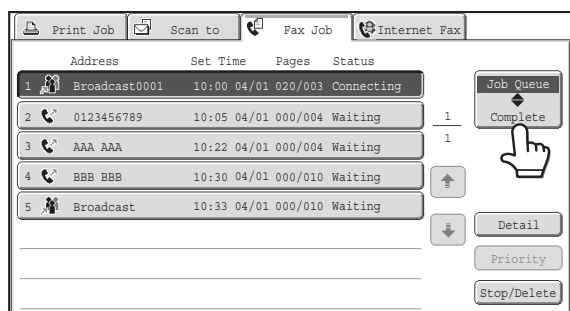

Touch the [Complete] key.

If the job status screen of fax mode does not appear, touch the [Fax Job] tab.



If the broadcast transmission included destinations of different modes, the same broadcast transmission key will appear in each of those modes.

3

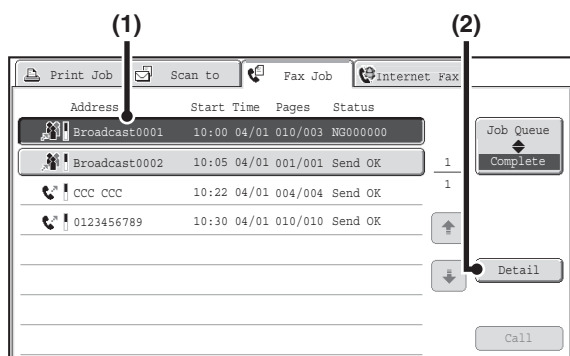

Display details on the broadcast transmission.

(1) Touch the key of the completed broadcast transmission.

(2) Touch the [Detail] key.



"Broadcastxxxx" will appear as the destination of the broadcast job key. The job control number that appeared in the touch panel when scanning ended appears in "xxxx".

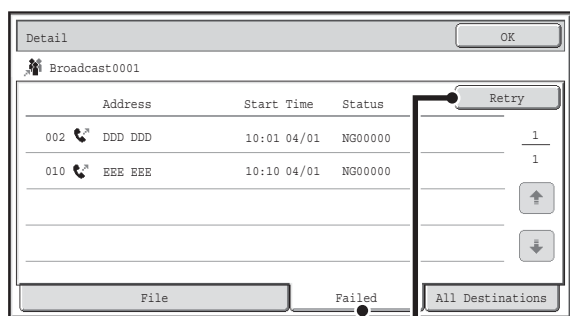

(1) (2)

**Resend to unsuccessful destinations.**

- (1) Touch the [Failed] tab.
- (2) Touch the [Retry] key.

4



- The procedure after the [Retry] key is touched varies depending on whether or not the document filing function was used.

**Not using document filing**

You will return to the base screen with the unsuccessful destinations entered. Place the original and perform the broadcast transmission operation.

**Using document filing**

The document filing operation selection screen will appear with the unsuccessful destinations entered. Perform the document filing resend procedure. (There is no need to rescan the original.)

If the job was stored in a confidential folder or was stored as confidential file, a password entry screen will appear after you touch the [Retry] key. Enter the password.

- If the [All Destinations] key is touched in (1), all destinations will be displayed. The [Retry] key that appears in the screen can be touched to resend to all destinations.

---

---

# SENDING A FAX DIRECTLY FROM A COMPUTER (PC-Fax)

A document in a computer can be transmitted via the machine as a fax. Faxes are sent using the PC-Fax function in the same way as documents are printed. Select the PC-Fax driver as the printer driver on your computer and then select the Print command in the software application. Image data for transmission will be created and sent as a fax.

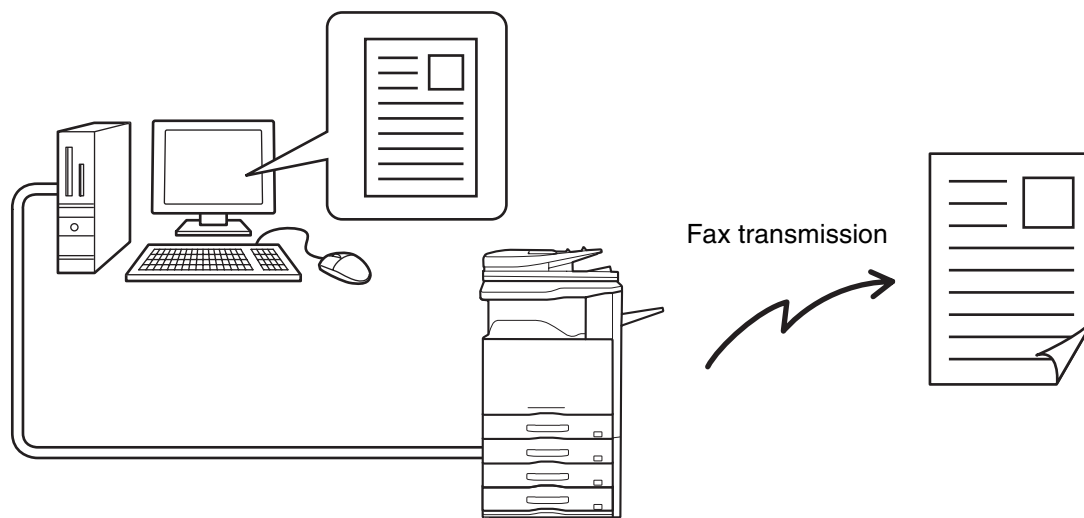

For more information on using PC-Fax, see the Help file for the PC-Fax driver.

- To use the PC-Fax function, the PC-Fax driver must be installed. For more information, see "1. BEFORE USING THE MACHINE".
- This function can only be used on a Windows® computer.
- This function can only be used for transmission. Faxes cannot be received to your computer.

# IMAGE SETTINGS

Settings for scanning the original are selected in the base screen of each mode. The current state of each setting appears to the right of the key used to select the setting.

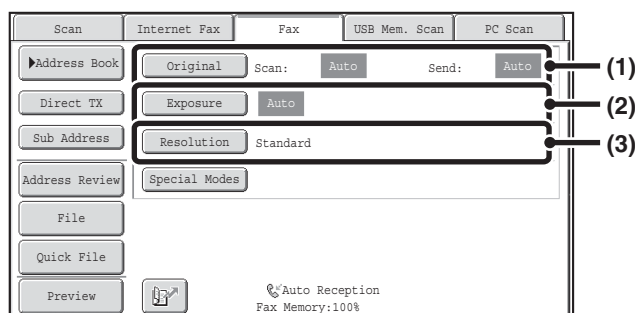

## (1) [Original] key

Touch this key to set the scan size, send size, and orientation of the original, and select 2-sided scanning settings.

☞ [AUTOMATICALLY SCANNING BOTH SIDES OF AN ORIGINAL \(2-Sided Original\)](#) (page 4-47)

☞ [SPECIFYING THE SCAN SIZE AND SEND SIZE \(Enlarge/Reduce\)](#) (page 4-48)

## (2) [Exposure] key

Touch this key to select the exposure for scanning.

☞ [CHANGING THE EXPOSURE](#) (page 4-55)

## (3) [Resolution] key

Touch this key to select the scanning resolution.

☞ [CHANGING THE RESOLUTION](#) (page 4-56)

# AUTOMATICALLY SCANNING BOTH SIDES OF AN ORIGINAL (2-Sided Original)

The automatic document feeder will automatically scan both sides of the document.

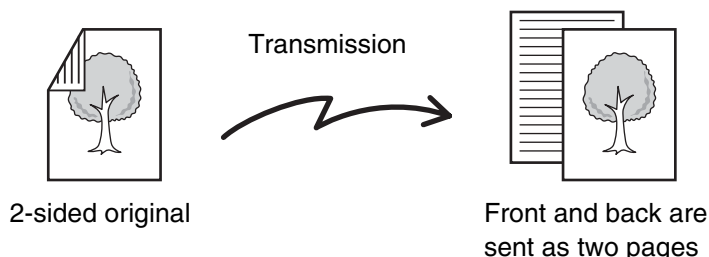

1

## Touch the [Original] key.

🔗 [IMAGE SETTINGS](#) (page 4-46)

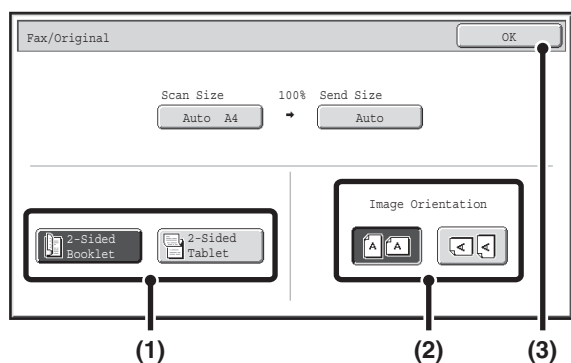

Specify the binding style of the 2-sided original (book or tablet) and the orientation in which the original is placed.

- Touch the [2-Sided Booklet] key or the [2-Sided Tablet] key.

A book and a tablet are bound as shown below.

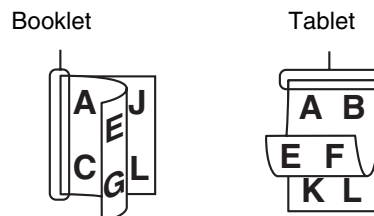

- Touch the appropriate [Image Orientation] key.  
If the wrong orientation is selected here, the image may not be sent properly.
- Touch the [OK] key.

2



To cancel 2-sided scanning, touch the highlighted key so that it is no longer highlighted.



- 2-sided scanning automatically turns off after the transmission operation is completed.
- 2-sided scanning is not possible when direct transmission or speaker transmission is performed.

## SPECIFYING THE SCAN SIZE AND SEND SIZE (Enlarge/Reduce)

When the original is placed, its size is automatically detected and displayed in the base screen.

The size of the placed original is indicated as the scan size, and the size to be transmitted is indicated as the send size.

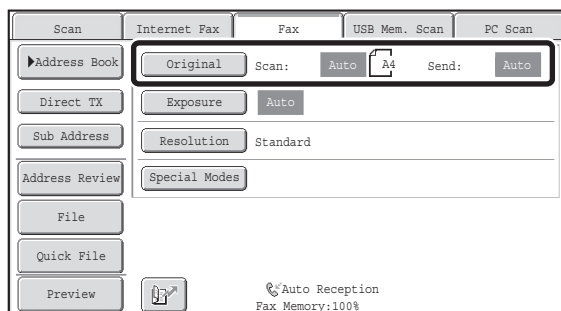

In the above screen, the scan size (the placed original) is A4 (8-1/2" x 11") and the send size is auto. If, for example, the scan size were A4 (8-1/2" x 11") and the send size were B5 (5-1/2" x 8-1/2"), the image would be reduced before transmission.

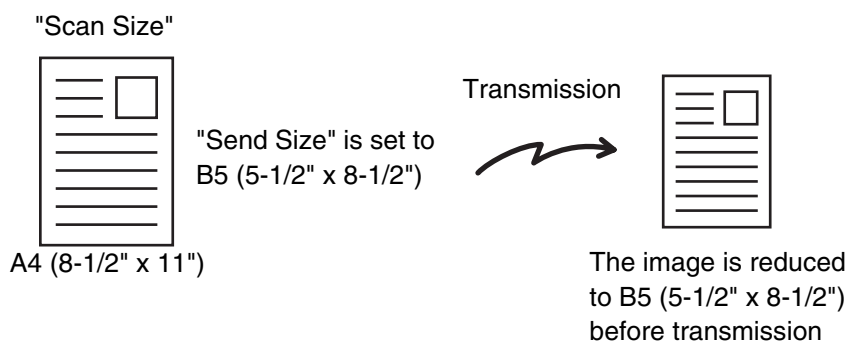

- Only standard original sizes can be automatically detected.  
 ➤ [STANDARD SIZES](#) (page 4-29)
- When the original size is a non-standard size, or if the size is not detected correctly, manually specify the original scan size.  
 ➤ [Specifying the original scan size \(by paper size\)](#) (page 4-49)  
 ➤ [Specifying the original scan size \(by numerical values\)](#) (page 4-51)



## Specifying the original scan size (by paper size)

If the original is a non-standard size or you wish to change the scan size, touch the [Original] key to specify the original size manually. Place the original in the document feeder tray or on the document glass and follow the steps below.

### 1 Touch the [Original] key.

The automatically detected original size appears to the right of the [Original] key.

☞ [IMAGE SETTINGS](#) (page 4-46)

### 2

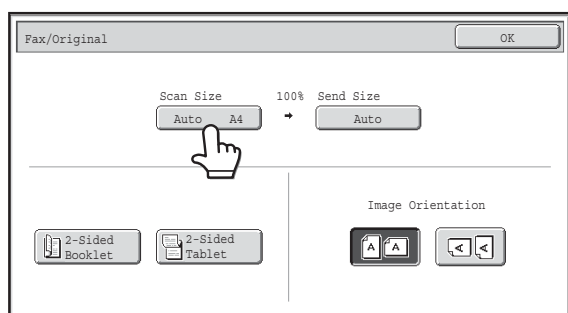

### Touch the [Scan Size] key.

### 3

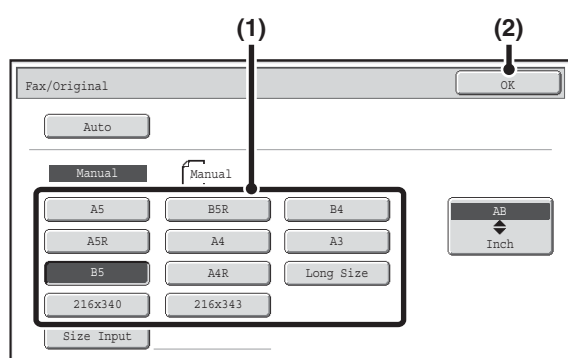

### Specify the scan size.

- (1) Touch the appropriate original size key.
- (2) Touch the [OK] key.



- If you are sending a long original, touch the [Long Size] key. Use the automatic document feeder to scan a long original. The maximum length that can be scanned is 1000 mm (39-3/8") (the maximum height is 297 mm (11-5/8")).  
☞ [TRANSMITTABLE ORIGINAL SIZES](#) (page 4-29)
- To specify an Inch size for the scan size, touch the [AB ◆ Inch] key to highlight the [Inch] side and then specify the scan size.

4

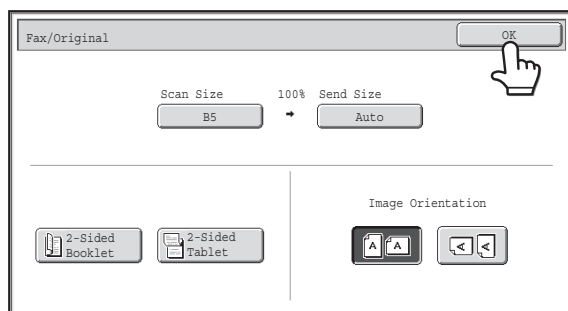

Touch the [OK] key.



When [Long Size] is selected, the 2-sided scanning setting and send size cannot be changed.

## Specifying the original scan size (by numerical values)

When scanning a non-standard size original such as a postcard or card, follow these steps to specify the original size. The width can be from 25 mm to 432 mm (1" to 17"), and the height can be from 25 mm to 297 mm (1" to 11-5/8").

### 1 Touch the [Original] key.

1

The automatically detected original size appears to the right of the [Original] key.

🔗 [IMAGE SETTINGS](#) (page 4-46)

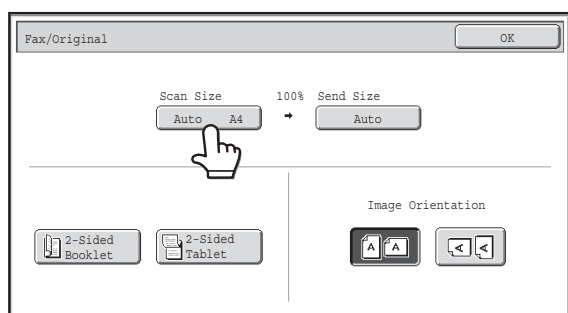

2

### 2 Touch the [Scan Size] key.

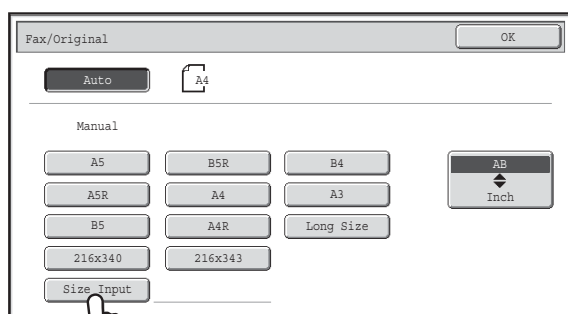

3

### 3 Touch the [Size Input] key.

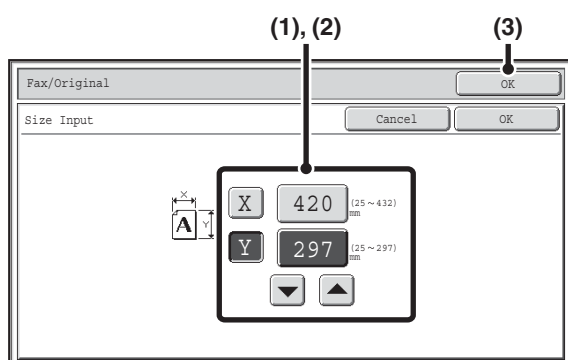

4

### 4 Enter the scan size.

- (1) Touch the X (width) numeric value display key and enter the width.
- (2) Touch the Y (height) numeric value display key and enter the height.
- (3) Touch the [OK] key.

To complete the setting and return to the screen of step 3, touch the [OK] key next to the [Cancel] key.



You can also touch the   keys to change the number.

5

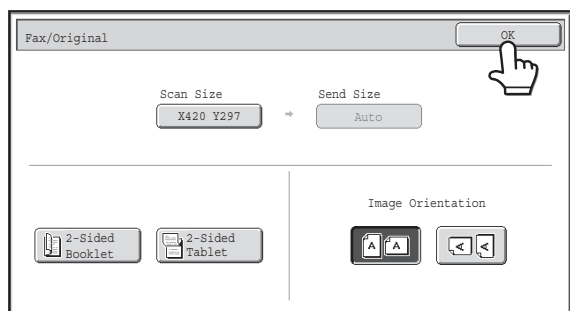

### Touch the [OK] key.

The specified size appears in the [Scan Size] key.

- When the scan size is specified by numerical values, the send size cannot be specified.
- When the automatic document feeder is used, an original longer than 432 mm (17") can be scanned (maximum width 1000 mm (39-3/8")). In this case, touch the [Long Size] key in the screen of step 3.
  - [Specifying the original scan size \(by paper size\)](#) (page 4-49)
  - [TRANSMITTABLE ORIGINAL SIZES](#) (page 4-29)

## Specifying the send size of the original

Specify the send size as a paper size. If a send size bigger than the scan size is selected, the image will be enlarged. If a send size smaller than the scan size is selected, the image will be reduced.

 The send size cannot be specified when [Long Size] is selected for the scan size, or when the scan size is specified by numerical values.

### 1 Touch the [Original] key.

 [IMAGE SETTINGS](#) (page 4-46)

### 2

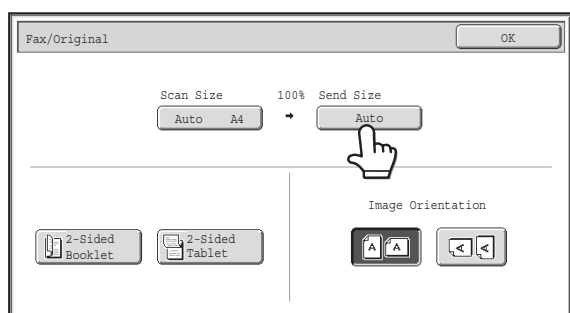

Touch the [Send Size] key.

### 3

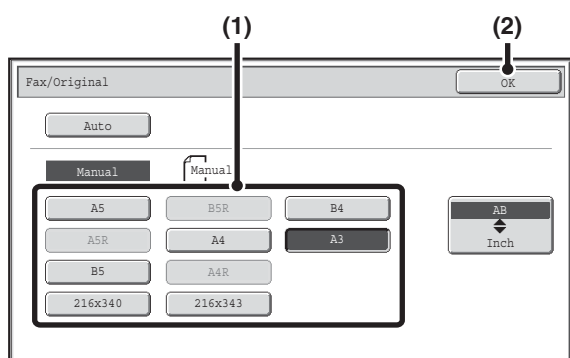

Specify the send size.

- (1) Touch the desired send size key.
- (2) Touch the [OK] key.

-  Depending on the "Scan Size" setting, it may not be possible to select some sizes for the "Send Size". Size keys that cannot be specified for the "Send Size" are greyed out to prevent selection.
- To specify an Inch size for the send size, touch the [AB  $\blacklozenge$  Inch] key to highlight the [Inch] side and then specify the send size.

4

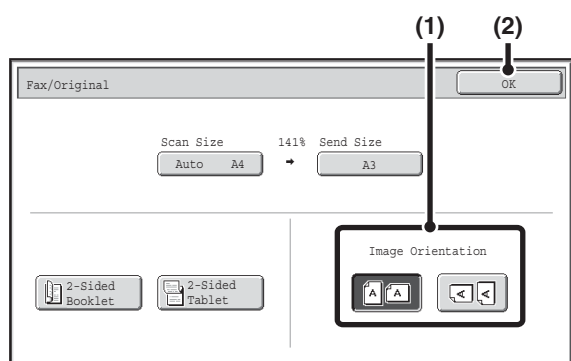

**Specify the orientation in which the original is placed.**

**(1) Touch the appropriate [Image Orientation] key.**

If the wrong orientation is selected here, the image may not be sent properly when using enlargement/reduction.

**(2) Touch the [OK] key.**



The ratio used for reduction or enlargement of the original will appear between the "Scan Size" and the "Send Size".

# CHANGING THE EXPOSURE

The exposure can be changed to match the darkness of the original. Refer the following tables to select appropriate settings.

## Exposure settings

Exposure		When to select
Auto		This setting automatically adjusts the exposure for light and dark parts of the original.
Manual	1-2	Select this setting when the original consists of dark text.
	3	Select this setting for a normal original (neither dark nor light).
	4-5	Select this setting when the original consists of faint text.

1

### Touch the [Exposure] key.

The current exposure setting appears to the right of the [Exposure] key.

➤ [IMAGE SETTINGS](#) (page 4-46)

2

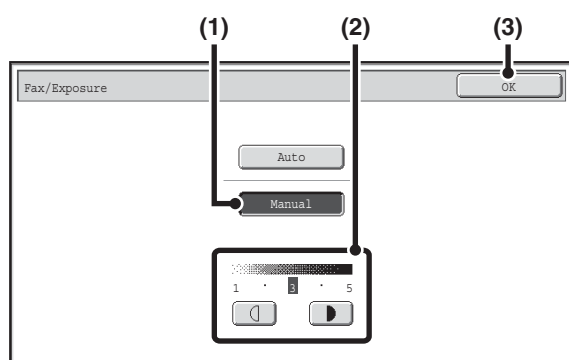

### Select the exposure.

(1) Touch the [Manual] key.

(2) Adjust the exposure with the keys.

When the exposure is set to [Auto], the keys cannot be used.

The exposure darkens when the key is touched, and lightens when the key is touched.

To return to auto exposure adjustment, touch the [Auto] key.

(3) Touch the [OK] key.

When using the document glass to scan multiple original pages, the exposure setting can be changed each time you change pages. When using the automatic document feeder, the exposure setting cannot be changed once scanning has begun. (However, when "Job Build" in the special modes is used, the exposure can be changed each time a new set of originals is inserted.)

#### System Settings (Administrator): Default Exposure Settings

This is used to change the default exposure setting.

# CHANGING THE RESOLUTION

The resolution can be selected to match the characteristics of the original, such as text or photo, the size of the text, and the darkness of the image.

Refer the following tables to select appropriate settings.

## Resolution settings

Resolution	When to select
Standard	Select this setting when your original consists of normal-sized text (like the text in this manual).
Fine	Select this setting when your original has small text or diagrams with fine lines. The original will be scanned at twice the resolution of the [Standard] setting.
Super Fine	Select this setting when your original has intricate pictures or diagrams. A higher-quality image will be produced than with the [Fine] setting.
Ultra Fine	Select this setting when your original has intricate pictures or diagrams. This setting gives the best image quality. However, transmission will take longer than with the other settings.
Half Tone	Select this setting when your original is a photograph or has gradations of colour (such as a colour original). This setting will produce a clearer image than [Fine], [Super Fine], or [Ultra Fine] used alone. Halftone cannot be selected when [Standard] is used.

1

### Touch the [Resolution] key.

The current resolution setting appears to the right of the [Resolution] key.

 [IMAGE SETTINGS](#) (page 4-46)

2

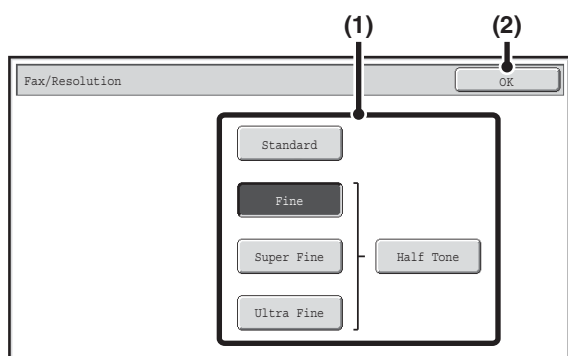

### Select the resolution.

(1) Touch the key of the desired resolution.

(2) Touch the [OK] key.



When [Fine], [Super Fine], or [Ultra Fine] is selected, the [Half Tone] key can be touched to select halftone.



- When using the document glass to scan multiple original pages, the resolution setting can be changed each time you change pages. When using the automatic document feeder, the resolution setting cannot be changed once scanning has begun. (However, when "Job Build" in the special modes is used, the resolution can be changed each time a new set of originals is inserted.)
- When a fax is sent at [Ultra Fine], [Super Fine], or [Fine] resolution, a lower resolution will be used if the receiving machine does not have that resolution.



#### System Settings (Administrator): Initial Resolution Setting

This is used to change the default resolution setting.



# CHECKING THE IMAGE TO BE TRANSMITTED (Preview)

(On the MX-2314N, the productivity kit is required.)

If you touch the [Preview] key before scanning the original, you can check the scanned image in the touch panel before sending the image.

\* The factory default setting is disabled.



Depending on the size of the transmission data, part of the preview image may not appear in the preview screen in the touch panel.

## 1

### Place the original.

Place the original face up in the document feeder tray, or face down on the document glass.

## 2

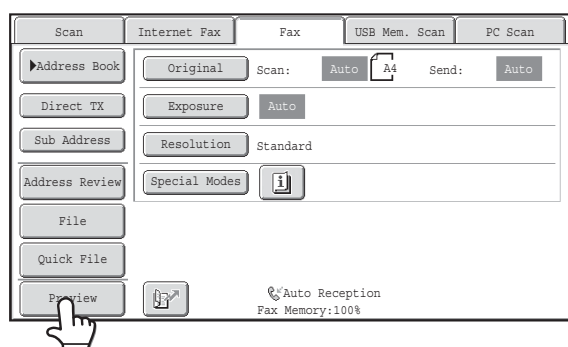

Touch the [Preview] key to highlight it.

## 3

### Select transmission settings and press the [BLACK & WHITE START] key.

"Originals are being read" appears while the originals are being scanned, and when scanning is finished, the preview screen appears on the touch panel. Transmission will not take place until you touch the [Start Sending] key in the preview screen.

## 4

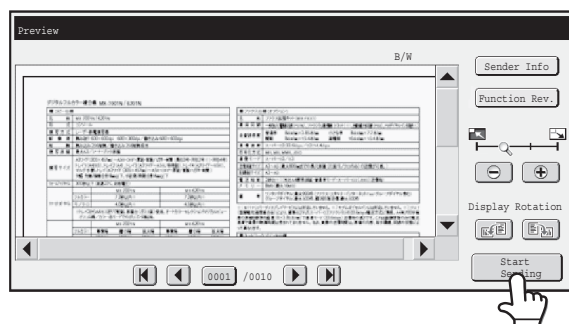

Check the preview image and then touch the [Start Sending] key.

Transmission begins.

For information on the preview screen, see "[PREVIEW CHECK SCREEN](#)" (page 4-58).



### System settings (administrator): Default Preview

You can specify whether or not the [Preview] key function will be enabled in the base screens of the image send modes and in the address book.

# PREVIEW CHECK SCREEN

This section explains the preview check screen.

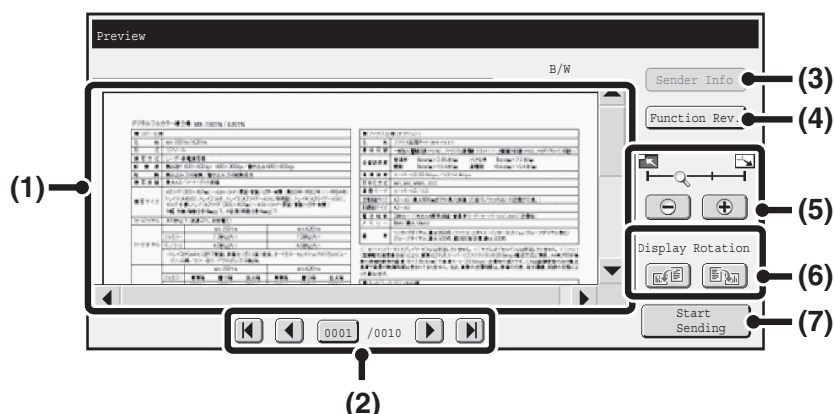

## (1) Preview image

A preview of the scanned original appears. If the image is cut off, use the scroll bars at the right and bottom of the screen to scroll the image. Touch a bar and slide it to scroll. (You can also touch the keys to scroll.)

## (2) Change page keys

When there are multiple pages, use these keys to change pages.

- keys: Go to the first or the last page.
- keys: Go to the previous page or the next page.
- Page number display: This shows the total number of pages and the current page number. You can touch the current page number key and enter a number with the numeric keys to go to that page number.

## (3) [Sender Info] key

Touch to display the sender information for fax own number. This key can only be touched when the entire preview image is displayed in the preview screen.

## (4) [Function Rev.] key

Touch to check special mode settings or scan settings for two-sided originals.

## (5) Display zoom key

Use this to set the zoom ratio of the displayed image. Changes from the left in the order "Full Page", "Twice", "4 Times", "8 Times". The setting applies to all pages in the file, not just the displayed page.

## (6) "Display Rotation" key

This rotates the image right or left by 90 degrees. The rotation applies to all pages in the file, not just the displayed page.

## (7) [Start Sending] key

Touch to begin transmission.



- A preview image is an image for display on the touch panel. It will differ from the actual send result.
- The preview image reflects certain scanning and special mode settings. Settings reflected in the preview image are as follows:  
Scanning settings: Original  
Special modes: Erase, Dual Page Scan, Card Shot, 2in1

# FAX RECEPTION



This section explains the basic procedures for receiving faxes.

## RECEIVING FAXES

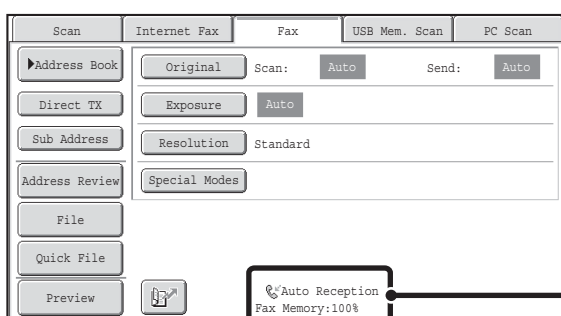
When the reception mode is set to "Auto Reception", the machine will receive and print faxes automatically. The fax reception mode is displayed in the base screen.



This shows the current fax reception mode and the amount of free memory remaining.

- 
  - When fax reception is in progress, it is possible to reserve a transmission by performing the transmission in memory transmission mode.  
 [TRANSMISSION METHODS](#) (page 4-26)
  - To print received faxes, make sure that the required paper is loaded in the machine's paper trays. It is not necessary to load A4 (8-1/2" x 11") paper and B5 (5-1/2" x 8-1/2") paper in both the vertical (📄) and horizontal (📄) orientations. Differences in orientation are automatically adjusted when faxes are received.  
 When a fax smaller than A4 (8-1/2" x 11") size is received, the size of the paper used for printing will vary depending on the orientation (vertical or horizontal) in which the sender placed the original.
- 
  - **System Settings: [Receive Setting](#) (page 7-109)**  
 This is used to change the fax reception mode. "Auto Reception" should normally be used. Select "Manual Reception" when an extension phone is connected to the machine.
  - **System Settings (Administrator): [Allow/Reject Number Setting](#)**  
 You can store numbers and specify whether or not reception is allowed from those numbers.

# RECEIVING A FAX

When a fax is transmitted to the machine, the machine automatically receives and prints the fax.

1

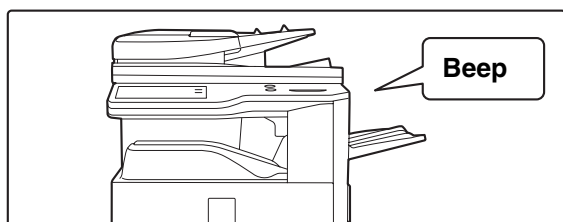

## The machine rings and fax reception begins automatically.

A beep sounds when reception ends.



- **System Settings (Administrator): Speaker Settings**

This is used to change the volume and tone of the reception beep.

- **System Settings (Administrator): Number of Calls in Auto Reception**

This is used to change the number of rings on which fax reception begins automatically. To receive faxes without the machine ringing, select "0" rings.

2

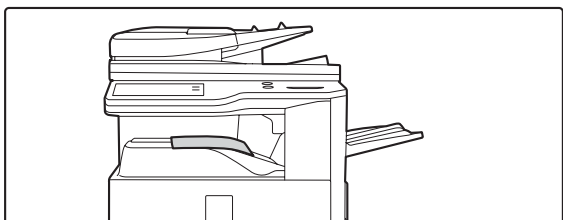

## The fax is automatically printed.



- **If a password entry screen appears...**

A password must be entered to print the received fax. When the correct password is entered, the received fax is printed.

📖 [PRINTING A PASSWORD-PROTECTED FAX \(Hold Setting For Received Data Print\)](#) (page 4-62)

- **The output tray and stapling (when a finisher is installed) can be selected.**

The number of copies of received faxes that are printed and the output tray can be selected. When a finisher is installed, the number of copies printed, the output tray, and stapling can be selected.



- If printing of a copy job or print job is in progress when a fax is received, the fax will not be printed until the previously reserved job is completed.
- Received faxes will not be printed when the machine cannot print due to an error condition such as out of paper, out of toner, or a paper misfeed. The faxes will be printed automatically when the error condition is cleared. (If the machine ran out of paper, touch the [OK] key in the touch panel after loading paper.)
- When received faxes cannot be printed, the faxes can be forwarded to another fax machine.  
📖 [FORWARDING RECEIVED FAXES \(Fax Data Forward\)](#) (page 4-67)



- **System Settings (Administrator): Duplex Reception Setting**

This is used to have received faxes printed on both sides of the paper.

- **System Settings (Administrator): Receiving Date & Time Print**

Use this to select whether or not the date and time of reception is added when a received image is printed.

## RECEIVING A FAX MANUALLY

A fax can be received manually using the touch panel. While the machine rings, touch the [Speaker] key in the base screen and then touch the [Fax Manual Reception] key that appears.

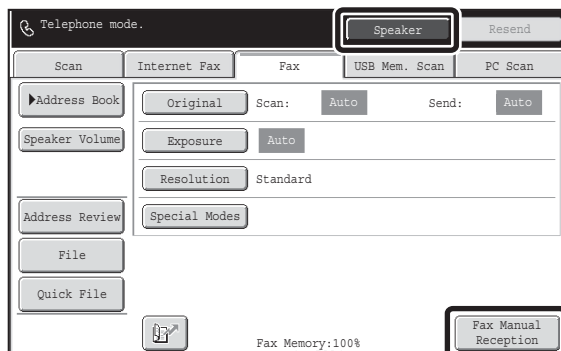



- When a call is answered by touching the [Speaker] key, you will be able to hear the other party, however, you will not be able to speak.
- Even when you use an extension phone to answer a call, you can touch the [Fax Manual Reception] key in the touch panel to begin fax reception. You can also use the extension phone to begin fax reception.
  - [RECEIVING A FAX AFTER ANSWERING A CALL ON THE EXTENSION PHONE \(Remote Reception\)](#) (page 4-127)

# PRINTING A PASSWORD-PROTECTED FAX (Hold Setting For Received Data Print)

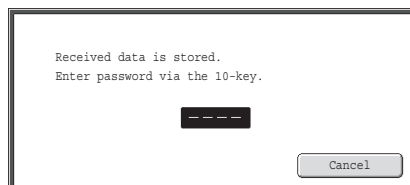

"Hold Setting for Received Data Print" can be enabled in the system settings (administrator) to have faxes received to memory without being printed. To print the faxes, a password must be entered. When this function is used, a password entry screen appears in the touch panel when a fax is received.



When the previously programmed 4-digit password is entered with the numeric keys, printing begins.

The [Cancel] key can be touched to close the password entry screen. If this is done, the data in memory key (  ) will blink in the touch panel. The password entry screen will reappear when you touch the blinking key (  ) or change modes.

When "Received Data Image Check Setting" is enabled in the system settings (administrator), a password can be entered to display the received data list screen. If you wish to check an image before printing it, continue from step 2 on the next page.

-  • The received faxes will be retained in memory regardless of whether they were received automatically or manually.
-  • If "Fax Data Receive/Forward" is executed in the system settings to forward received faxes to another machine, faxes retained in memory will also be forwarded. At that time, the same password entry screen as for printing will appear. Forwarding will not take place unless the password is entered.

-  **System Settings (Administrator): Hold Setting for Received Data Print**  
Enable this setting to have received faxes retained in memory until a password is entered. This setting is also used to program the password.

# CHECKING THE IMAGE BEFORE PRINTING

(On the MX-2314N, the productivity kit is required.)

When "Received Data Image Check Setting" is enabled\* in the system settings (administrator), you can check a received image in the touch panel before printing it out. When this function is enabled, follow the steps below to print a received image.

\* The factory default setting is disabled.

 Depending on the size of the received data, part of the image in the image check screen on the touch panel may not appear.

1

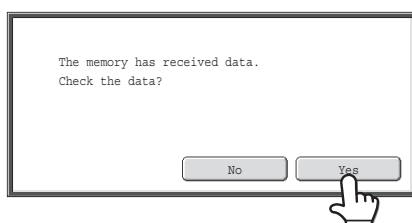

**When an image is received, a confirmation prompt will appear. Touch the [Yes] key.**

If this message appears while you are configuring settings of any type and you touch the [Yes] key, the settings that you are configuring will be cancelled. If this message appears in another mode, you will return to the base screen of image send mode after checking the image.

2

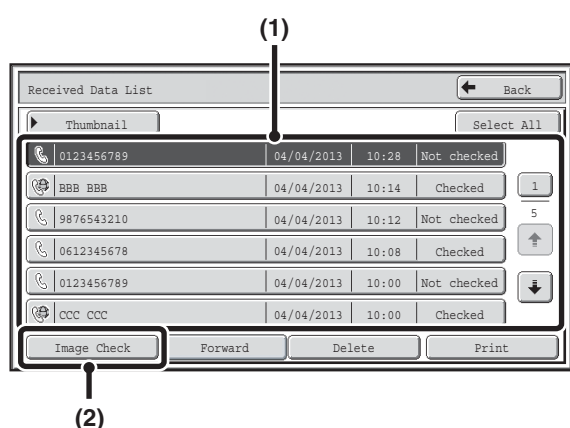

**Select the received image**

**(1) Touch the key of the received image that you want to check.**

Multiple received images can be checked.

**(2) Touch the [Image Check] key.**

- To show thumbnails of the received images, touch the [Thumbnail] key.
- To delete an image that has been selected, touch the [Delete] key. To print an image that has been selected, touch the [Print] key.

3

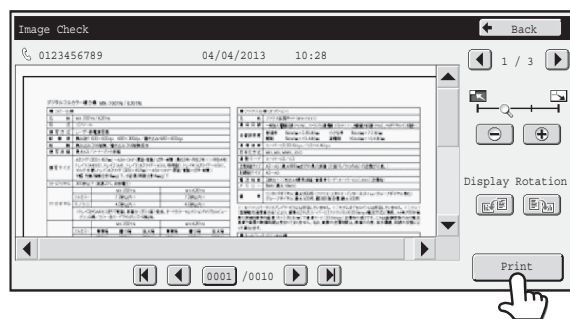

**Check the received image and then touch the [Print] key.**

Printing begins.

For information on the image check screen, see "[IMAGE CHECK SCREEN](#)" (page 4-66).

 If the screen of step 1 appears when you are configuring settings in the setting screens of any of the modes, the configured settings will be cancelled if you view the image. After viewing the image, you will return to the base screen of image send mode, regardless of which mode you were in previously.

 **System Settings (Administrator): Received Data Image Check Setting**  
Use this to specify whether or not a received fax can be viewed before it is printed.

# CHECKING THE IMAGE BEFORE FORWARDING

(On the MX-2314N, the productivity kit is required.)

When "Received Data Image Check Setting" is enabled in the system settings (administrator), you can select the received data from the list and forward it to the addresses recorded in the address book. When this function is enabled, follow the steps below to forward the received image.

\* The factory default setting is disabled.

 Depending on the size of the received data, part of the image in the image check screen on the touch panel may not appear.

1

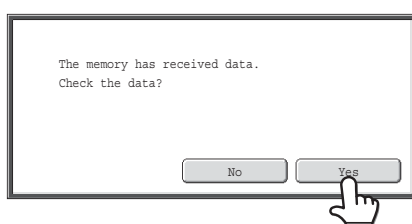

**When an image is received, a confirmation prompt will appear. Touch the [Yes] key.**

If this message appears while you are configuring settings of any type and you touch the [Yes] key, the settings that you are configuring will be cancelled. If this message appears in another mode, you will return to the base screen of image send mode after checking the image.

2

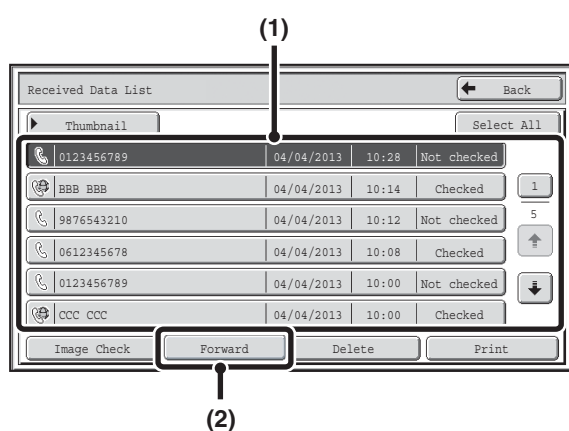

**Select the received image**

**(1) Touch the key of the received image that you want to check.**

Multiple received images can be checked.

**(2) Touch the [Forward] key.**

- To show thumbnails of the received images, touch the [Thumbnail] key.
- To check a received image, touch the [Image Check] key.

 [IMAGE CHECK SCREEN](#) (Page 4-66)

3

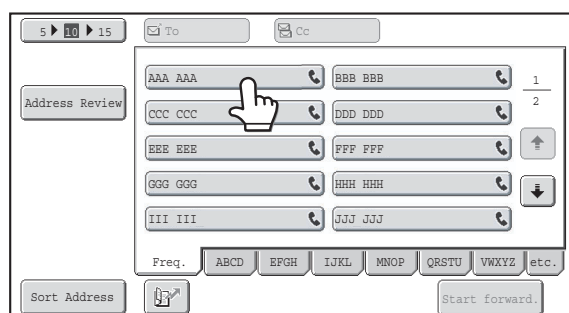

**Touch the Forward Destination from the address book to select it.**

Multiple forwarding addresses can be checked.



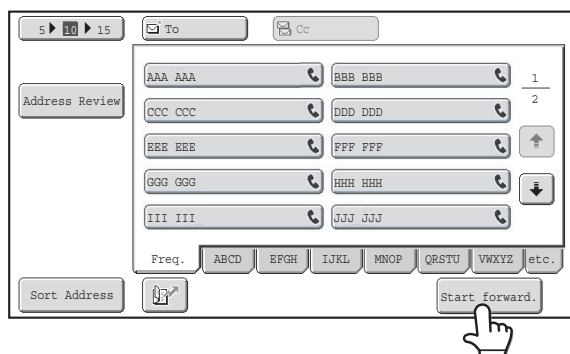

4



## Start forward

Touch the [Start forward.] key.

 If the screen of step 1 appears when you are configuring settings in the setting screens of any of the modes, the configured settings will be cancelled if you view the image. After viewing the image, you will return to the base screen of image send mode, regardless of which mode you were in previously.

 **System Settings (Administrator): Received Data Image Check Setting**  
Use this to specify whether or not a received Internet fax can be viewed before it is printed.

# IMAGE CHECK SCREEN

This section explains the image check screen.

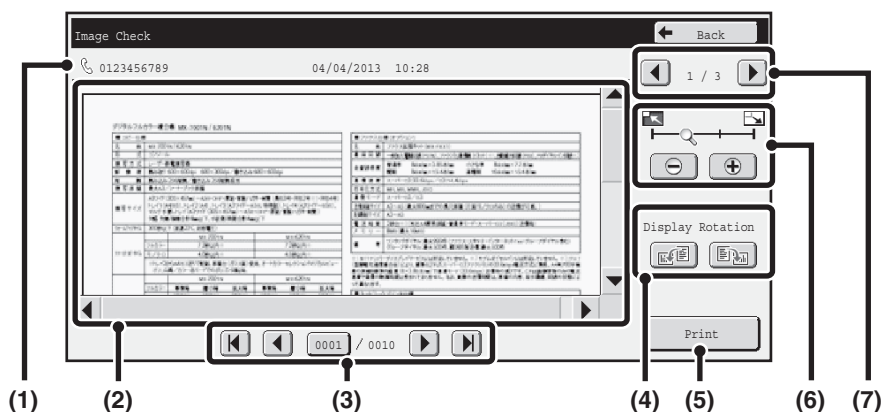

## (1) Information display

This shows information on the displayed image.

## (2) Preview image

An image of the selected received image appears. If the image is cut off, use the scroll bars at the right and bottom of the screen. Touch a bar and slide it to scroll. (You can also touch the keys to scroll.)

## (3) Change page keys

When there are multiple pages, use these keys to change pages.

- keys: Go to the first or the last page.
- keys: Go to the previous page or the next page.
- Page number display: This shows the total number of pages and the current page number. You can touch the current page number key and enter a number with the numeric keys to go to that page number.

## (4) "Display Rotation" key

This rotates the image right or left by 90 degrees. The rotation applies to all pages in the file, not just the displayed page.

## (5) [Print] key

Touch to start printing.

## (6) Display zoom key

Use this to set the zoom ratio of the displayed image. Changes from the left in the order "Full Page", "Twice", "4 Times", "8 Times". The setting applies to all pages in the file, not just the displayed page.

## (7) Image select key

When multiple images are selected for preview display, use this to change the displayed images.



A preview image is an image for display on the touch panel. It will differ from the actual print result.

# FORWARDING RECEIVED FAXES (Fax Data Forward)

When the machine cannot print because it is out of paper or out of toner, received faxes can be forwarded to another previously programmed fax machine.

This function is convenient in an office or work area that has two or more telephone lines and another fax machine is connected to a different line than the machine.

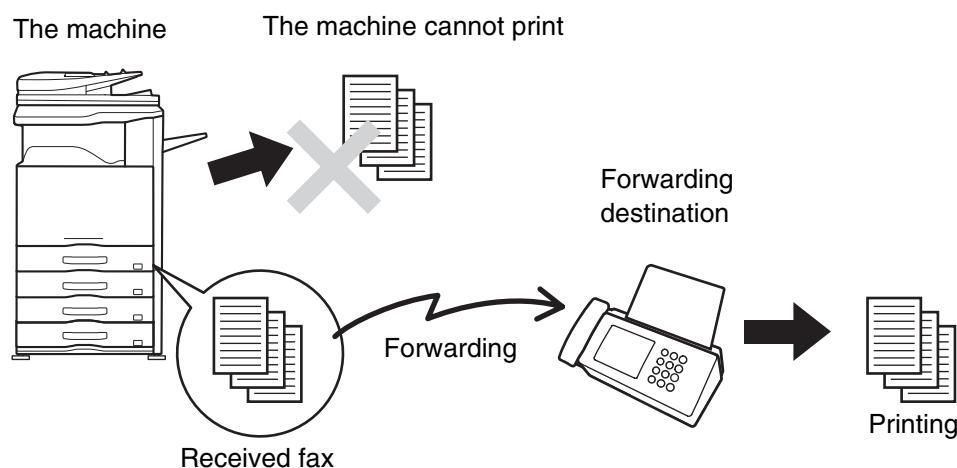

Forwarding of received faxes is executed in the system settings of the machine. Touch the [SYSTEM SETTINGS] key (◆) on the touch panel to display the system setting menu screen in the touch panel. Select [Fax Data Receive/Forward] - [Fax Settings], and then touch the key that executes received fax forwarding.

- If some pages of a fax that is being forwarded were successfully printed, only those pages that were not printed will be forwarded.
- A forwarded fax becomes a fax transmission job. If transmission does not take place because the transmission was cancelled or an error occurred, the fax will be held in memory until it can be printed.
- All faxes received are forwarded. Note, however, that faxes received to an F-code confidential memory box cannot be forwarded.
- If a password entry screen appears after touching the [OK] key, "Hold Setting for Received Data Print" has been enabled. Enter the password with the numeric keys to begin forwarding.
  - ▶ [PRINTING A PASSWORD-PROTECTED FAX \(Hold Setting For Received Data Print\)](#) (page 4-62)

- **System Settings: Fax Data Receive/Forward (page 7-22)**  
Use this to forward received faxes when the machine is unable to print.
- **System Settings (Administrator): Set the Telephone Number for Data Forwarding**  
This is used to store the forwarding fax number.

# FORWARDING RECEIVED FAXES TO AN ADDRESS (Inbound Routing Settings)

You can have received faxes automatically forwarded to a facsimile internet fax, e-mail address, file server address, desktop address, or network folder address. This function can be used to forward received faxes to a specified address without printing them.

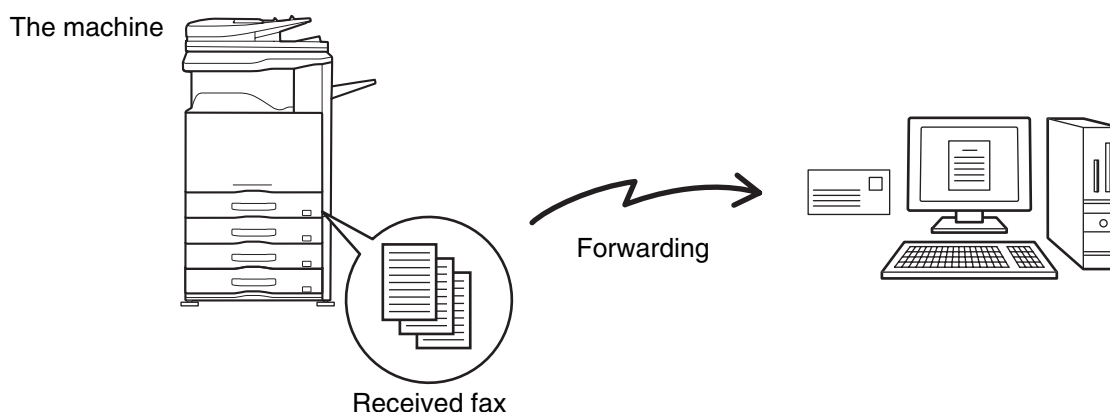

- This function cannot be used for faxes received by confidential reception.
- When faxes forwarded using this function are printed at the forwarding destination, the date and time of reception cannot be printed on the faxes. ("Receiving Date & Time Print" is disabled.)

## CONFIGURING INBOUND ROUTING SETTINGS

All inbound routing settings are configured in the Web pages. For the procedure for accessing the Web pages, see the Start Guide.

The following explanation assumes that the Web pages have been accessed with administrator rights. To configure inbound routing settings, follow the steps below.

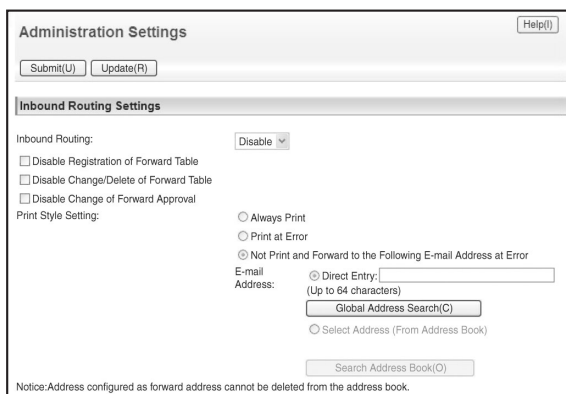

## Enabling the inbound routing function.

- (1) In the Web page menu, click [Application Settings], [Inbound Routing Settings], and then [Administration Settings].
- (2) Select [Enable] in "Inbound Routing" and click the [Submit] button.

1



Users without administrator rights can be prohibited from storing, editing, and deleting forwarding tables in this screen, and from specifying which table is used. To do so, select the checkboxes below .

- Disable Registration of Forward Table
- Disable Change/Delete of Forward Table
- Disable Change of Forward Approval

When inbound routing is enabled, you can also specify whether or not you wish the machine to print the forwarded faxes.

To have all received faxes printed before being forwarded, select "Print Out All Report" in "Print Style Setting". To have received faxes printed only when an error prevents forwarding, select "Print at Error".

If an error occurs when [Not Print and Forward to the Following E-mail Address at Error] is selected, received data is not printed, but is forwarded to the specified e-mail address.

After configuring the settings, be sure to click the [Submit] button.

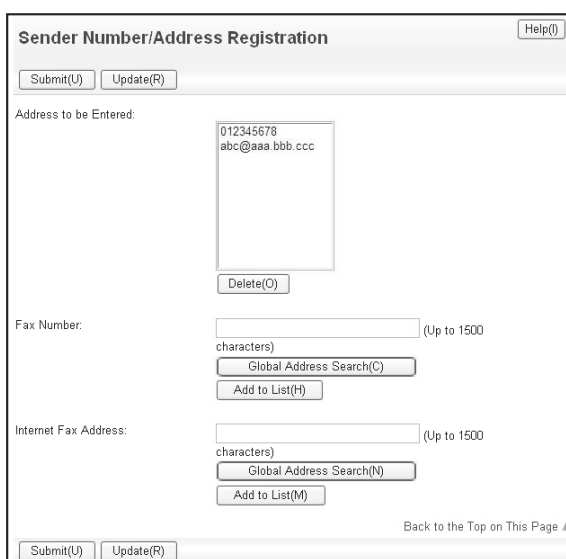

## Storing sender addresses.

If you wish to have only faxes from specified addresses forwarded, store the desired sender addresses. Send addresses stored here can be selected from a list when you store a forwarding table.

- (1) Click [Sender Number/Address Registration] in the [Inbound Routing Settings] menu in the Web page.
- (2) Enter the sender address in "Internet Fax Address" or "Fax Number" as appropriate, and click the [Add to List] button.

The entered address will be added to the "Address to be Entered" list.

- Specify whether the address will be directly entered (maximum of 1500 characters) or selected from a global address book by clicking the [Global Address Search] button.
- To store multiple addresses, repeat this step.

- (3) When you have finished adding addresses, click the [Submit] button.

2



- A maximum of 500 sender numbers/addresses can be stored.
- To delete an entered address, select the address in "Address to be Entered" and click the [Delete] button.

## Store a forwarding table.

Follow the steps below to store a forwarding table that combines a specified sender and forwarding address.

(1) Click [Inbound Routing Settings] in the Web page menu and click the [Add] button.

(2) Enter a "Table Name".

(3) Select the line used for reception.

(4) Select the sender whose faxes will be forwarded.

- To forward all received faxes, select [Forward All Received Data].

- To forward only data received from specific senders, select [Forward Received Data from Below Sender]. To forward all data except data from specific senders, select [Forward Received Data from Senders except Below]. Select the appropriate senders from the list and click the [Add] button.

(5) Select the forwarding conditions.

- To always forward received data, select [Always Forward].

- To specify a day and time on which received data will be forwarded, select [Forward on Selected Day & Time] and select the checkbox  of the desired day of the week. To specify a time, select the [Set Forwarding Time] checkbox  and specify the time.

(6) Select the file format.

The format can be set separately for each forwarding address (for each of forwarding addresses 1, 2, and 3 in the table).

(7) Select the forwarding address.

Forwarding addresses can be selected from the machine's address book. (Multiple addresses can be selected.) A maximum of 1000 forwarding addresses can be stored (a combined maximum of 100 facsimile, internet fax, file server, desktop, and network folder addresses can be stored).

(8) Click [Submit].



- When selecting senders from the "Sender Number/Address Setting" list, you can use the [Shift] key or the [Ctrl] key on your keyboard to select multiple senders.
- A maximum of 50 forwarding tables can be stored.
- Images sent in TIFF format may not display correctly in some recipient environments. In this event, change the file format to PDF.
- Up to three forwarding day and time settings can be set for one forwarding table, and a forwarding destination can be set for each set time. To configure these settings, use the forwarding list tabs to access each setting.

(2)

**Inbound Routing Settings** Login(P) Help(I)

Inbound Routing Settings: Enable  
Display Items: 10

Table Name	Forward Condition
<input type="checkbox"/> Table 1	<input type="radio"/> Not Forward <input type="radio"/> Always Forward <input type="radio"/> Forward on Selected Day & Time
	Forward Destination 1
	Forward Destination 2
	Forward Destination 3
<input type="checkbox"/> Table 2	<input type="radio"/> Not Forward <input type="radio"/> Always Forward <input type="radio"/> Forward on Selected Day & Time
	Forward Destination 1
	Forward Destination 2
<input type="checkbox"/> Table 3	<input type="radio"/> Not Forward <input type="radio"/> Always Forward <input type="radio"/> Forward on Selected Day & Time
	Forward Destination 1
	Forward Destination 2
	Forward Destination 3

Total Table: 3  
 1/1

Back to the Top on This Page

(3)

## Specifying forwarding tables to be used.

To use the inbound routing function, enable the forwarding tables that you wish to use from among the stored tables.

(1) Click [Inbound Routing Settings] in the Web page menu.

(2) Select [Always Forward] or [Forward on Selected Day & Time] from the forwarding table.

The forwarding permission settings that appear here are linked to the forwarding conditions set in step 3. If you wish to use different forwarding conditions than those set in step 3, set the forwarding permission settings.

(3) Click [Submit].





To delete a forwarding table, click the checkbox next to the table name so that it is selected  and click [Delete].

# SPECIAL MODES

This section explains special modes that can be used for fax transmission.

## SPECIAL MODES

When the [Special Modes] key is touched in the base screen, the special modes menu screen appears. The special modes menu consists of two screens. Touch the   key to switch between the two screens. When the [OK] key is touched in the special modes screen, the selected settings are entered and the base screen reappears.

### 1st screen

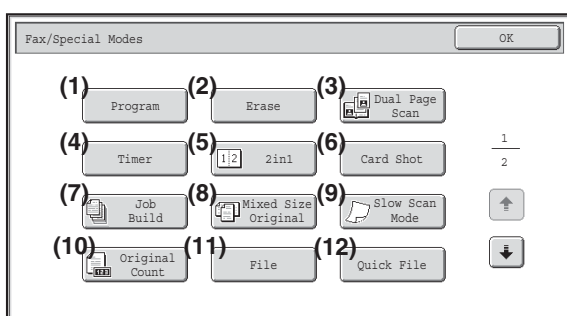

### 2nd screen

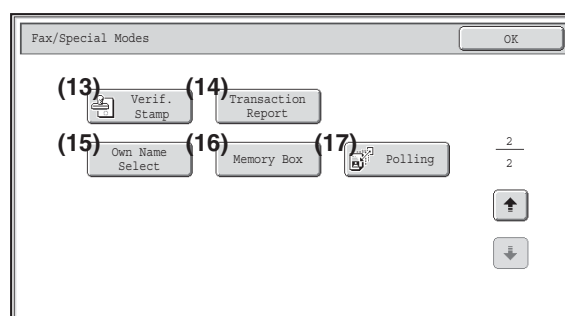

- |   |   |
|---|---|
| <p>(1) <b>[Program] key</b><br/>  <a href="#">STORING FAX OPERATIONS (Program)</a> (page 4-74)</p> <p>(2) <b>[Erase] key</b><br/>  <a href="#">ERASING PERIPHERAL SHADOWS ON THE IMAGE (Erase)</a> (page 4-76)</p> <p>(3) <b>[Dual Page Scan] key</b><br/>  <a href="#">TRANSMITTING AN ORIGINAL AS TWO SEPARATE PAGES (Dual Page Scan)</a> (page 4-78)</p> <p>(4) <b>[Timer] key*1</b><br/>  <a href="#">SENDING A FAX AT A SPECIFIED TIME (Timer)</a> (page 4-80)</p> <p>(5) <b>[2in1] key</b><br/>  <a href="#">SENDING TWO PAGES AS A SINGLE PAGE (2in1)</a> (page 4-82)</p> <p>(6) <b>[Card Shot] key</b><br/>  <a href="#">SENDING BOTH SIDES OF A CARD AS A SINGLE PAGE (Card Shot)</a> (page 4-85)</p> <p>(7) <b>[Job Build] key</b><br/>  <a href="#">SENDING A LARGE NUMBER OF PAGES (Job Build)</a> (page 4-88)</p> | <p>(8) <b>[Mixed Size Original] key</b><br/>  <a href="#">TRANSMITTING ORIGINALS OF DIFFERENT SIZES (Mixed Size Original)</a> (page 4-90)</p> <p>(9) <b>[Slow Scan Mode] key</b><br/>  <a href="#">FAXING THIN ORIGINALS (Slow Scan Mode)</a> (page 4-92)</p> <p>(10) <b>[Original Count] key</b><br/>  <a href="#">CHECKING THE NUMBER OF SCANNED ORIGINAL SHEETS BEFORE TRANSMISSION (Original Count)</a> (page 4-94)</p> <p>(11) <b>[File] key*1</b><br/>           Touch this to use the File function of document filing mode.</p> <p>(12) <b>[Quick File] key*1</b><br/>           Touch this to use the Quick File function of document filing mode.</p> <p>(13) <b>[Verif. Stamp] key*2</b><br/>  <a href="#">STAMPING SCANNED ORIGINALS (Verif. Stamp)</a> (page 4-96)</p> |
|---|---|



**(14) [Transaction Report] key**

☞ CHANGING THE PRINT SETTINGS FOR THE TRANSACTION REPORT (Transaction Report) (page 4-98)

**(16) [Memory Box] key**

☞ SENDING A FAX WHEN ANOTHER MACHINE POLLS YOUR MACHINE (Polling Memory) (page 4-105)

**(15) [Own Name Select] key**

☞ TEMPORARILY CHANGING THE SENDER INFORMATION (Own Name Select) (page 4-101)

**(17) [Polling] key**

☞ CALLING A FAX MACHINE AND INITIATING RECEPTION (Polling) (page 4-102)

\*1 On the MX-2314N, the productivity kit is required.  
 \*2 Does not appear when the stamp unit is not installed.

 Special modes can generally be combined with other special modes, however, there are some combinations that are not possible. If a prohibited combination is selected, a message will appear in the touch panel.

## [OK] key and [Cancel] key

In some cases two [OK] keys and one [Cancel] key will appear in the special mode screens. The keys are used as follows:

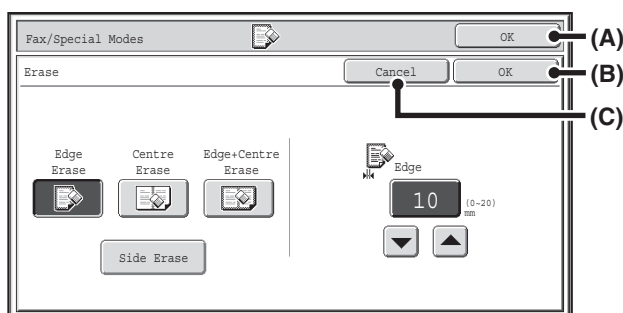

- (A) Enter the selected special mode setting and return to the base screen.
- (B) Enter the selected special mode setting and return to the special modes menu screen. Touch this key when you wish to continue selecting other special mode settings.
- (C) During selection of special mode settings, this returns you to the special modes menu screen without saving the settings. When settings have been completed, this cancels the settings and returns you to the special modes menu screen.

# STORING FAX OPERATIONS (Program)

A program is a group of transmission settings stored together. When transmission settings are stored in a program, the settings can be retrieved and used for a fax job by means of a simple operation.

For example, suppose that the same A4 (8-1/2" x 11") size documents are distributed to branch offices in various regions once a month.

- (1) The same documents are faxed to each branch office
- (2) To save paper, two document pages are faxed as a single page
- (3) Smudges on the edges of the documents are erased before transmission

A4 (8-1/2" x 11") size documents to be distributed

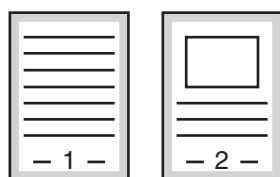

Fax received by recipients.



When a job program is not stored	When a job program is stored
<p>Enter the fax numbers of the branch offices</p> <p>↓</p> <p>Select the 2in1 function.</p> <p>↓</p> <p>Select erase settings</p> <p>↓</p> <p>Press the [BLACK &amp; WHITE START] key. The originals are scanned and transmitted.</p>	<p>Retrieve the stored program.</p> <p>↓</p> <p>Press the [BLACK &amp; WHITE START] key. The originals are scanned and transmitted.</p>
<p>Considerable time is required to send the documents each month because the above settings must be selected. In addition, mistakes may occasionally be made when selecting the settings, so incorrect transmissions may occur.</p>	<p>When a program is stored, settings are selected with ease by simply pressing the program key. In addition, transmission takes place based on the stored settings so there are no chances for mistakes.</p>

- **Programs are stored, edited, and deleted using "Address Control" in the system settings. See "Program" (page 7-21) in "7. SYSTEM SETTINGS".**
- Programs can also be stored using the Web pages. Click [Job Programs] and then [Image Send] in the Web page menu.
- The settings stored in a program will be retained even after the program is used for transmission. The same settings can be used repeatedly for transmission.
- The following settings can be stored in programs.
  - Destinations: One-touch keys, group keys, search numbers
  - Image settings: Original scan size, original orientation, duplex scanning, exposure, resolution
  - Special modes: Polling reception, Erase, Dual Page Scan, Job Build, Mixed Size Original, Slow Scan Mode, Original Count, Verif. Stamp, 2in1
- F-code communication: A destination that includes an F-code can be stored to perform an F-code operation.
- Up to 48 programs can be stored.
- Up to 500 destinations can be stored in each program.

## 1 Place the original.

- Place the original in the document feeder tray or on the document glass as appropriate for the functions stored in the program.

## 2 Select the special modes.

- Touch the [Special Modes] key.
  - Touch the [Program] key.
- SPECIAL MODES** (page 4-72)

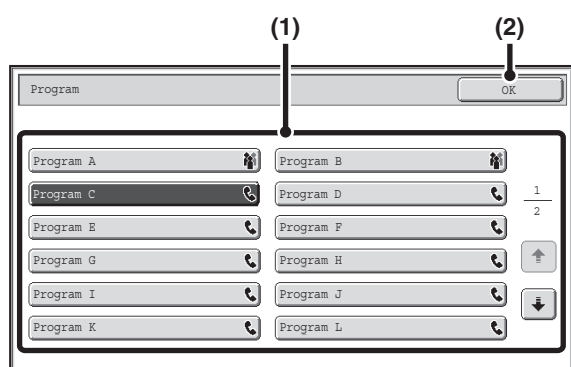

## 3 Retrieve the stored program.

- Touch the desired program key.
- Touch the [OK] key.

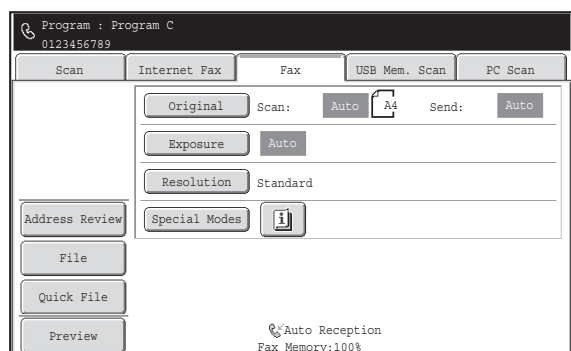

## 4 Select additional settings.

When a program is used, the following settings can be additionally specified:

- Image settings: Original scan size\*, send size
- Special modes: Timer Transmission, Card Shot, File, Quick File, Own Name Select, Transaction Report

\* When stored in the program, this cannot be additionally specified.



- The screen that appears will vary depending on the destination stored in the program.
- The mode cannot be changed here.
- Functions stored in the program cannot be cancelled here.

## 5 Press the [BLACK & WHITE START] key.

Scanning begins.

- If you inserted the original pages in the document feeder tray, all pages are scanned. A beep will sound to indicate that scanning is finished.
- If you are scanning the original on the document glass, scan each page one page at a time. When scanning finishes, place the next original and press the [BLACK & WHITE START] key. Repeat until all pages have been scanned and then touch the [Read-End] key. A beep will sound to indicate that scanning is finished.



### To cancel scanning...

Press the [STOP] key ().

# ERASING PERIPHERAL SHADOWS ON THE IMAGE (Erase)

The erase function is used to erase shadows on images produced when scanning thick originals or books. (This function erases the parts of the image where shadows tend to form. The function does not detect shadows and erase only the shadows.)

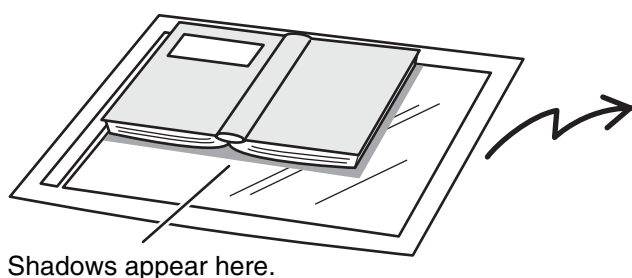

## Scanning a thick book

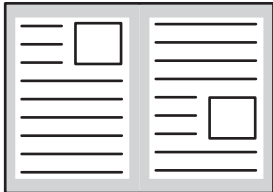
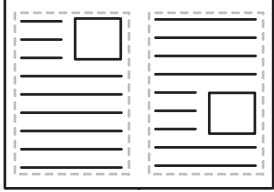

Not using the erase function	Using the erase function
 <p data-bbox="855 853 1150 880">Shadows appear in the image.</p>	 <p data-bbox="1190 853 1414 880">No shadows appear.</p>

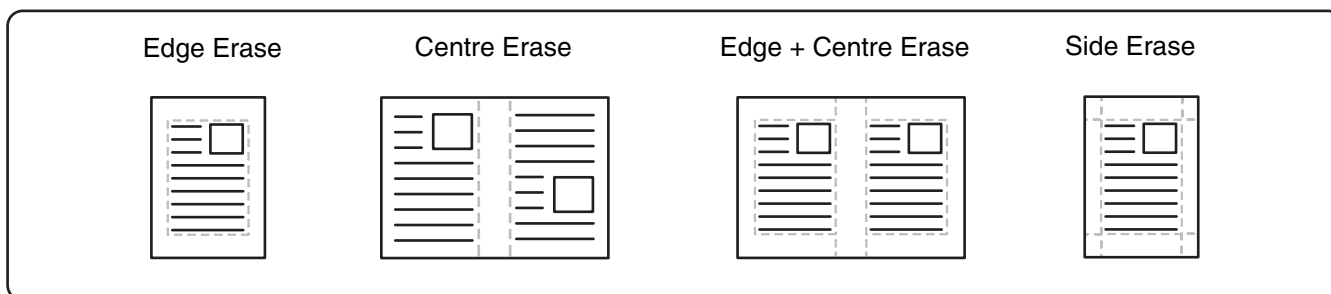
## Erase modes



- 1 Place the original.**  
 Place the original face up in the document feeder tray, or face down on the document glass.
- 2 Enter the destination fax number.**  
 [ENTERING DESTINATIONS](#) (page 4-17)
- 3 Select the special modes.**
  - (1) Touch the [Special Modes] key.
  - (2) Touch the [Erase] key. [SPECIAL MODES](#) (page 4-72)

4

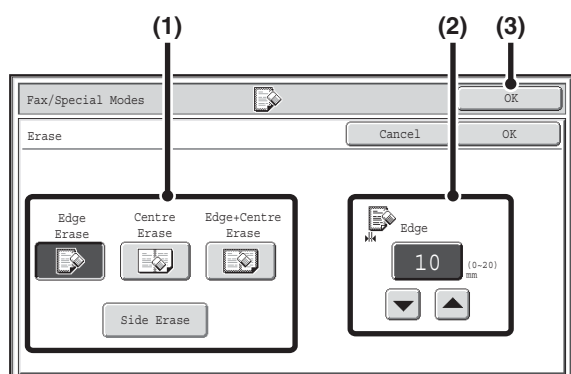

## Select the erase settings.

### (1) Touch the desired erase mode.

Select one of the 4 erase modes.

Touch the [Side Erase] key to open the following screen.

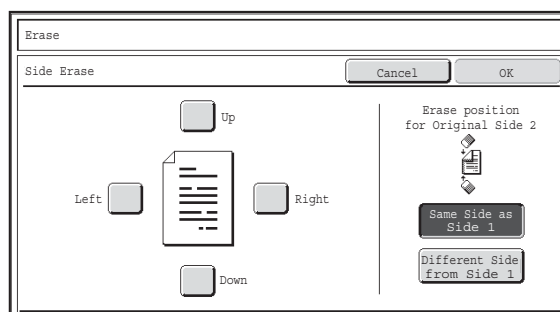

Touch the checkbox of the edge that you wish to erase and make sure that a checkmark (☑) appears.

When performing two-sided scanning, set the erase edge on the reverse side.

- If you touch the [Same Side as Side 1] key, the edge in the same position as on the front side will be erased.
- If you touch the [Different Side from Side 1], the edge in the position opposite to the erased edge on the front side will be erased.

When you have completed the settings, touch the [OK] key.

### (2) Set the erasure width with the keys.

0 mm to 20 mm (0" to 1") can be entered.

### (3) Touch the [OK] key.

5

## Press the [BLACK & WHITE START] key.

Scanning begins.

- If you inserted the original pages in the document feeder tray, all pages are scanned. A beep will sound to indicate that scanning is finished.
- If you are scanning the original on the document glass, scan each page one page at a time.

When scanning finishes, place the next original and press the [BLACK & WHITE START] key. Repeat until all pages have been scanned and then touch the [Read-End] key.

A beep will sound to indicate that scanning is finished.



### To cancel scanning...

Press the [STOP] key (.



When the erase function is used, erase takes place at the edges of the original image. If you also use a reduction or an enlargement setting, the erase width will change according to the selected ratio. For example, if the erase width setting is 20 mm (1") and the image is reduced to 50%, the erase width will be 10 mm (1/2").



### To cancel an erase setting...

Touch the [Cancel] key in the screen of step 4.



### System Settings (Administrator): Erase Width Adjustment

The default erase width setting is linked to the copy mode system setting, and can be set from 0 mm to 20 mm (0" to 1"). The factory default setting is 10 mm (1/2").

# TRANSMITTING AN ORIGINAL AS TWO SEPARATE PAGES (Dual Page Scan)

The left and right sides of an original can be transmitted as two separate pages. This function is useful when you wish to fax the left and right pages of a book or other bound document as separate pages.

**Example: Faxing the left and right pages of a book**

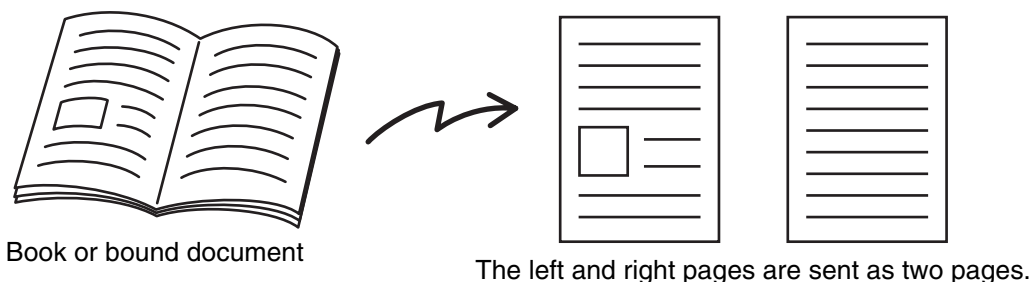

**Example:**

Original scan size	Transmitted image
A3 (11" x 17") x 1 page	A4 (8-1/2" x 11") x 2 pages



- When using dual page scan, the original must be placed on the document glass.
- The send size cannot be changed.

1

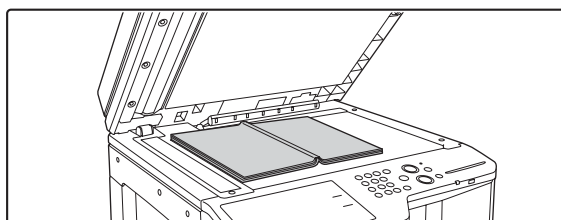

**Place the original face down on the document glass.**

Align the centre of the original with the appropriate size mark ▼.

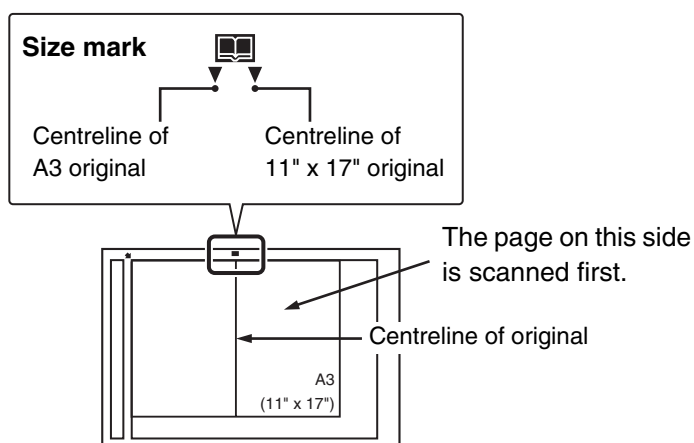

2

**Enter the destination fax number.**

[ENTERING DESTINATIONS](#) (page 4-17)

3

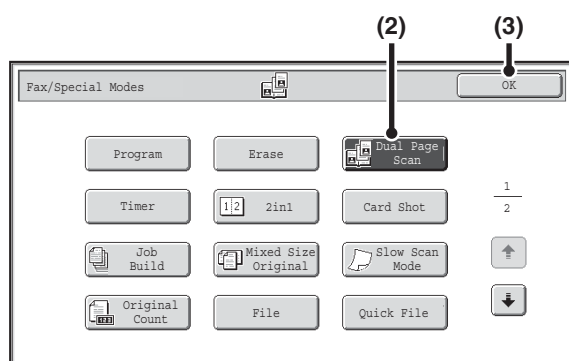

### Select Dual Page Scan.

- (1) Touch the [Special Modes] key.  
 ↳ [SPECIAL MODES](#) (page 4-72)
- (2) Touch the [Dual Page Scan] key so that it is highlighted.
- (3) Touch the [OK] key.



4

### Press the [BLACK & WHITE START] key.

Scanning begins.

When scanning finishes, place the next original and press the [BLACK & WHITE START] key. Repeat until all pages have been scanned and then touch the [Read-End] key.

A beep will sound to indicate that scanning is finished.

-  **To cancel scanning...**  
 Press the [STOP] key (.

-  • To erase shadows caused by the binding of a book or other bound document, use the erase function. (Note, however, that "Centre Erase" and "Edge + Centre Erase" cannot be used.)
- When the scan size of the original is specified by numerical values, this function cannot be used.

-  **To cancel Dual Page Scan...**  
 Touch the [Dual Page Scan] key in the screen of step 3 so that it is not highlighted.

# SENDING A FAX AT A SPECIFIED TIME (Timer)

(On the MX-2314N, the productivity kit is required.)

When this function is used, transmission takes place automatically at a specified time.

The timer transmission function makes it easy to perform reserved transmissions, broadcast transmissions and other transmissions at night or other times when phone rates are low.

A timer setting can also be specified for polling reception to receive a fax when you are not present.

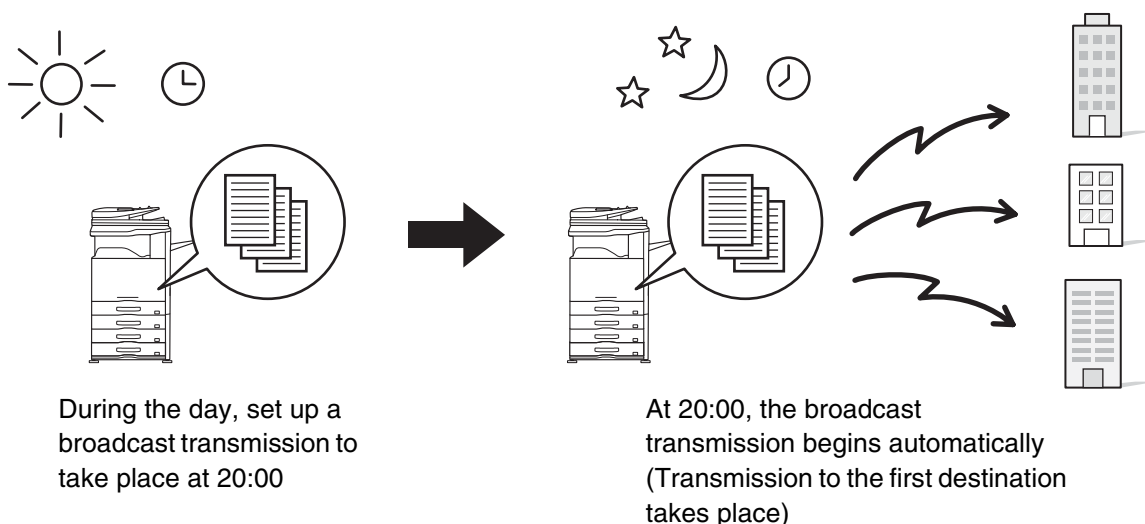

-  When a timer transmission is set, keep the main power switch "on". Transmission will not take place if the main power is turned off at the specified time.
- When performing a timer transmission, you must scan the original into memory when you set up the transmission. It is not possible to leave the document in the auto document feeder or on the document glass and have it scanned at the reserved time of transmission.
- Settings selected for a timer transmission (exposure, resolution, special modes, etc.) are automatically cleared after the transmission is finished. (However, when the document filing function is used, the scanned original and settings are stored on the built-in hard drive.)

1

## Place the original.

Place the original face up in the document feeder tray, or face down on the document glass.

2

## Enter the destination fax number.

 [ENTERING DESTINATIONS](#) (page 4-17)

3

## Select the special modes.

(1) Touch the [Special Modes] key.

(2) Touch the [Timer] key.

 [SPECIAL MODES](#) (page 4-72)



4

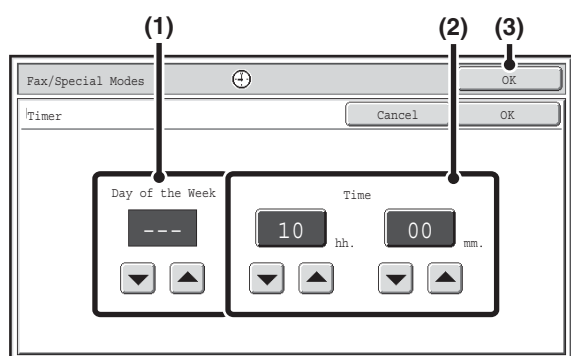

## Set the time with the keys.

### (1) Specify the day.

If you do not wish to specify a day, select [---]. In this case, transmission will begin when the time specified in (2) arrives.

### (2) Specify the time (hour, minute)

Select the time in 24-hour format.

You can also directly touch a numeric display key to change the setting with the numeric keys.

### (3) Touch the [OK] key.



When this screen is opened, the setting will show the current time. If the time is not correct, press the [CLEAR ALL] key (CA) to cancel the operation. Correct the time in the system settings and then perform the timer transmission procedure.

 [CHECKING THE DATE AND TIME](#) (page 4-6)

5

## Press the [BLACK & WHITE START] key.

Scanning begins.

- If you inserted the original pages in the document feeder tray, all pages are scanned. A beep will sound to indicate that scanning is finished.
- If you are scanning the original on the document glass, scan each page one page at a time. When scanning finishes, place the next original and press the [BLACK & WHITE START] key. Repeat until all pages have been scanned and then touch the [Read-End] key. A beep will sound to indicate that scanning is finished.



- The time can be specified up to a week in advance.
- Up to 94 timer transmissions can be stored at once.
- Only one timer polling operation can be stored at once. If you wish to poll multiple machines, store a serial polling timer operation.
- If another transmission is in progress when the specified time arrives, the timer operation will begin after that transmission is finished.
- Other operations can be performed after a timer transmission is set up.
- This function cannot be used in direct transmission mode or when the speaker is used to dial.
- If a timer transmission is given priority in the job status screen, the time specification is cancelled. The transmission will begin as soon as the job in progress is completed.

 [GIVING PRIORITY TO A RESERVED FAX JOB](#) (page 4-136)



### To cancel timer transmission...

Touch the [Cancel] key in the screen of step 4.

# SENDING TWO PAGES AS A SINGLE PAGE (2in1)

Two original pages can be reduced and sent as a single page. This function is convenient when you have a large number of original pages and wish to reduce the number of pages sent.

Portrait-oriented originals

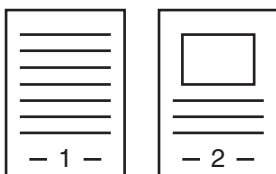

Transmission

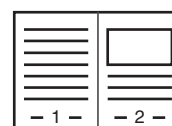

Landscape-oriented originals



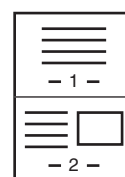

Transmission

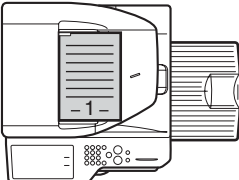
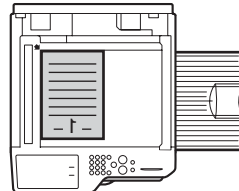

## Place the original.

 When placing the originals, orient them as shown below.

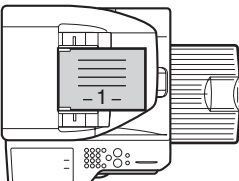
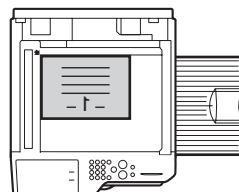
Originals	Document feeder tray Place the originals face up.	Document glass Place the originals face down.
Portrait orientation 		
Landscape orientation 		

1

2

## Enter the destination fax number.

 [ENTERING DESTINATIONS](#) (page 4-17)

3

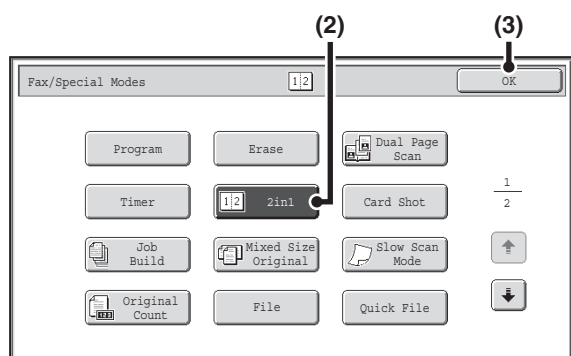

**Select 2in1.**

- (1) Touch the [Special Modes] key.  
 ☞ [SPECIAL MODES](#) (page 4-72)
- (2) Touch the [2in1] key so that it is highlighted.
- (3) Touch the [OK] key.

4

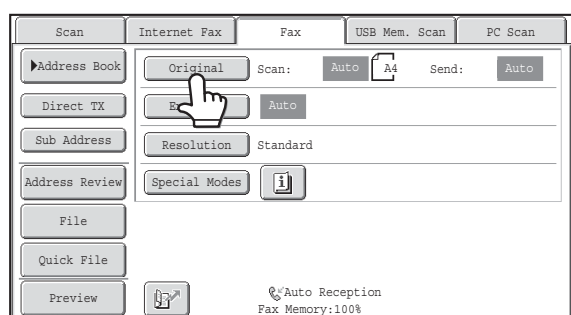

**Touch the [Original] key.**

5

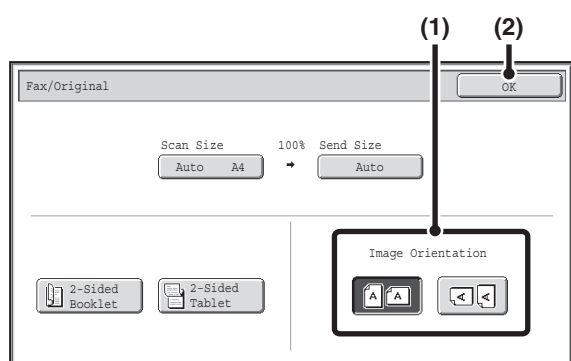

**Specify the orientation in which the original is placed.**

- (1) Touch the appropriate [Image Orientation] key.  
 If this setting is not correct, a suitable image may not be transmitted.
- (2) Touch the [OK] key.

6

**Press the [BLACK & WHITE START] key.**

Scanning begins.

- If you inserted the original pages in the document feeder tray, all pages are scanned.  
 A beep will sound to indicate that scanning is finished.
- If you are scanning the original on the document glass, scan each page one page at a time.  
 When scanning finishes, place the next original and press the [BLACK & WHITE START] key. Repeat until all pages have been scanned and then touch the [Read-End] key.  
 A beep will sound to indicate that scanning is finished.

☞ The [Configure] key can be touched in the scan-end confirmation screen to change the exposure, resolution, scan size, and send size. (However, when scanning each even-numbered page of the original, only the exposure can be changed.)

☞ **To cancel scanning...**  
 Press the [STOP] key (⏹).



- Transmission is not possible at a size smaller than the original size.
- This function cannot be used in direct transmission mode or when the speaker is used to dial.
- The 2in1 function cannot be used when the original is other than A4, B5 or A5 (8-1/2" x 11" or 5-1/2" x 8-1/2") size.
- When the scan size of the original is specified by numerical values, this function cannot be used.

**To cancel 2in1...**

Touch the [2in1] key in the screen of step 3 so that it is not highlighted.

# SENDING BOTH SIDES OF A CARD AS A SINGLE PAGE (Card Shot)

This function lets you send the front and reverse sides of a card as a single page, without the need to send each side separately.

Transmitted image

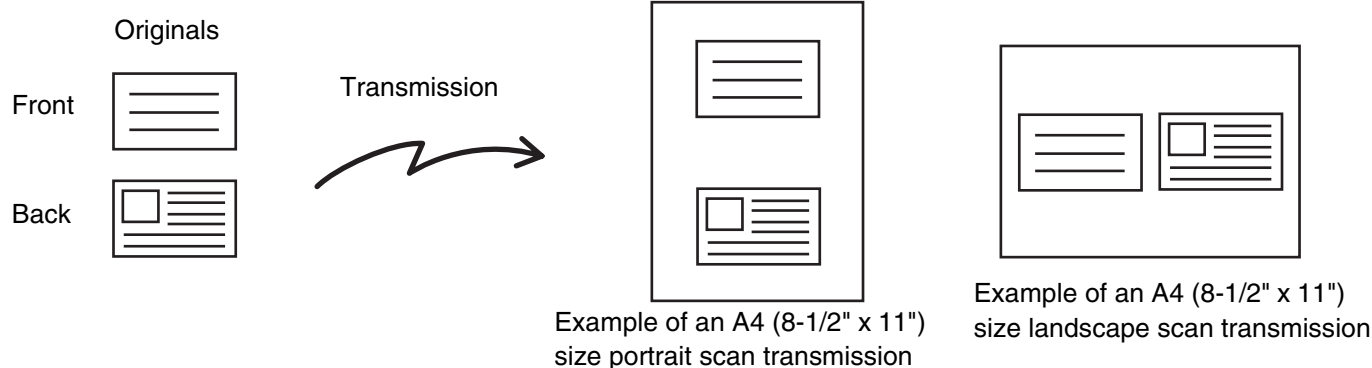

When using card shot, the original must be scanned on the document glass.

1

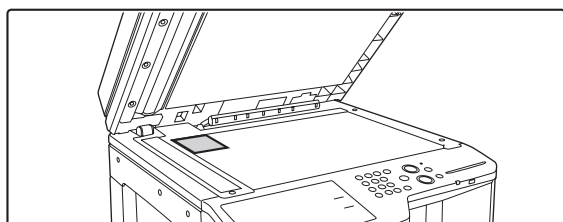

**Place the original face down on the document glass.**

2

**Enter the destination fax number.**

☞ [ENTERING DESTINATIONS](#) (page 4-17)

3

**Select the special modes.**

(1) Touch the [Special Modes] key.

(2) Touch the [Card Shot] key.

☞ [SPECIAL MODES](#) (page 4-72)

4

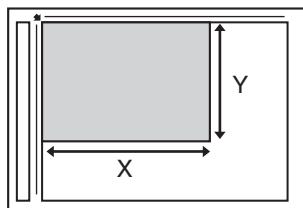
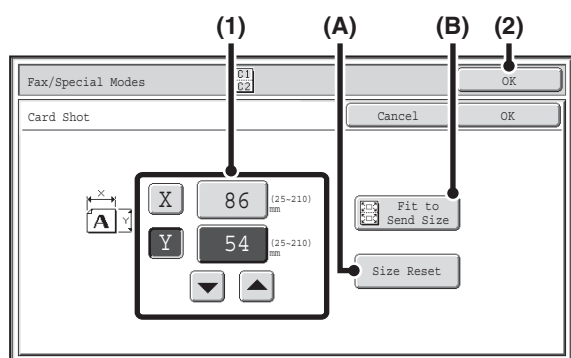

**Specify the original size.**

**(1) Enter the original size.**

- Touch the X (width) numeric value display key and enter the width.
- Touch the Y (height) numeric value display key and enter the height.

- (A) To return the original size to the default size, touch the [Size Reset] key.
- (B) To automatically enlarge or reduce the image size to the send size, touch the [Fit to Send Size] key. Do not touch this key if you wish to scan the original at the original size that you entered.

**(2) Touch the [OK] key.**



- You can also touch the keys to change the number.
- The send size is automatically selected based on the original size you entered.
- After selecting Card Shot, you can touch the [Original] key in the base screen to change the original scan size or the send size. In this case, the screen of step 3 appears when you touch the scan size key. For the procedure for setting the send size, see "[Specifying the send size of the original](#)" (page 4-53).

5



**To cancel scanning...**  
Press the [STOP] key ().

**Turn the card over so that the back is face down, and press the [BLACK & WHITE START] key to scan the back of the card.**

6



Before scanning the back of the card, you can touch the [Configure] key in the touch panel to change the exposure.



**To cancel scanning...**  
Press the [STOP] key ().

7

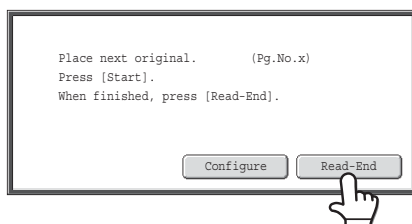

Touch the [Read-End] key.



If you will continue by scanning the front of the card, you can touch the [Configure] key to change the exposure, resolution, scan size, and send size.



- The ratio cannot be specified and "Rotation Sending Setting" cannot be selected.
- This function cannot be used in direct transmission mode or when the speaker is used to dial.



**To cancel Card Shot...**

Touch the [Cancel] key in the screen of step 4.

# SENDING A LARGE NUMBER OF PAGES (Job Build)

This function lets you separate an original consisting of numerous pages into sets, scan each set using the automatic document feeder, and transmit the pages in a single transmission. Use this function when there are more original pages than can be placed at once in the auto document feeder.

When scanning originals that are separated into sets, scan the set that has the first page first. The settings that you select for the first set can be used for all remaining sets.

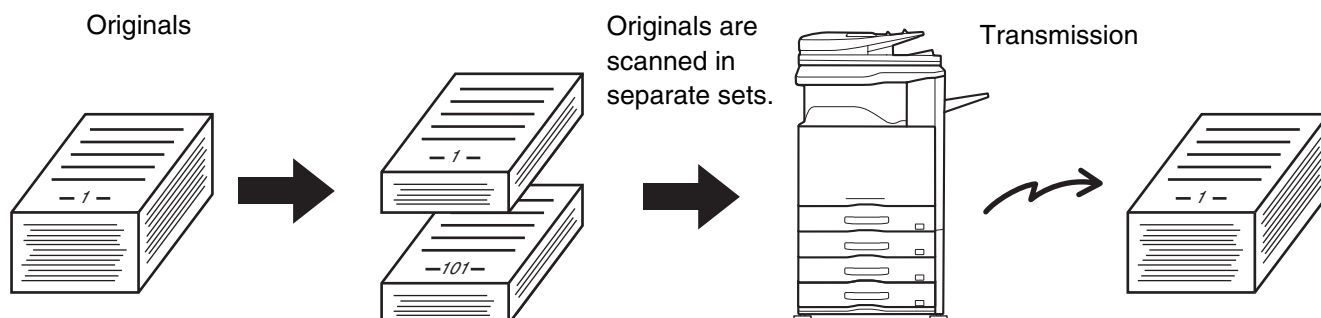

 Up to 999 pages can be scanned. Note that when the memory is being used for other jobs, fewer pages can be scanned.

1

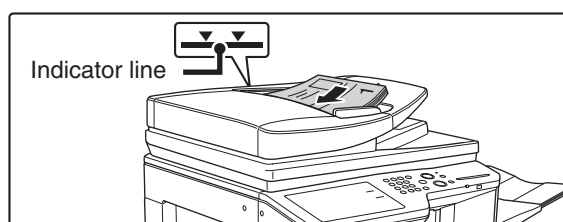

## Insert the originals face up in the document feeder tray.

Insert the originals all the way into the document feeder tray. Multiple originals can be placed in the document feeder tray. The stack of originals must not be higher than the indicator line on the tray.

2

## Enter the destination fax number.

 [ENTERING DESTINATIONS](#) (page 4-17)

3

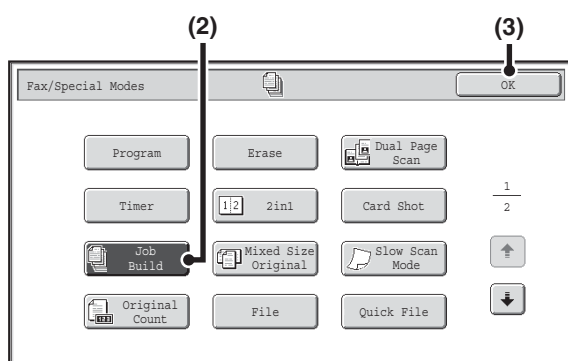

## Select job build mode.

(1) Touch the [Special Modes] key.

 [SPECIAL MODES](#) (page 4-72)

(2) Touch the [Job Build] key so that it is highlighted.

(3) Touch the [OK] key.



## 4 Press the [BLACK & WHITE START] key to scan the first set.

4



### To cancel scanning...

Press the [STOP] key (⏹).

## 5 Insert the next set of originals and press the [BLACK & WHITE START] key.

Repeat this step until all originals have been scanned.

5



### To cancel scanning...

Press the [STOP] key (⏹). All scanned data will be cleared.

6

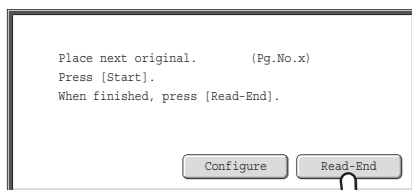

## Touch the [Read-End] key.



- If no action is taken for one minute after the confirmation screen appears, scanning automatically ends and the transmission is reserved.
- The [Configure] key can be touched to change the exposure, resolution, scan size, and send size for each original page scanned. However, when Job Build is used in combination with 2in1 in the special modes, only the exposure can be changed when scanning each even-numbered page of the original pages.



- If the memory becomes full during scanning, a message will appear and the transmission will be cancelled.
- This function cannot be used in direct transmission mode or when the speaker is used to dial.



### To cancel Job Build...

Touch the [Job Build] key in the screen of step 3 so that it is not highlighted.

# TRANSMITTING ORIGINALS OF DIFFERENT SIZES (Mixed Size Original)

This feature lets you scan and transmit originals of different sizes at the same time; for example, B4 (8-1/2" x 14") size originals mixed together with A3 (11" x 17") size originals. When scanning the originals, the machine automatically detects the size of each original.



This feature can only be used with the following combinations of original sizes:

- A3 and B4      • A3 and B5      • B4 and A4      • A4 and B5
- A4R and B5    • B4 and A4R    • B4 and A5      • B5 and A5
- 11" x 17" and 8-1/2" x 14"      • 11" x 17" and 8-1/2" x 13"      • 11" x 17" and 5-1/2" x 8-1/2"

1

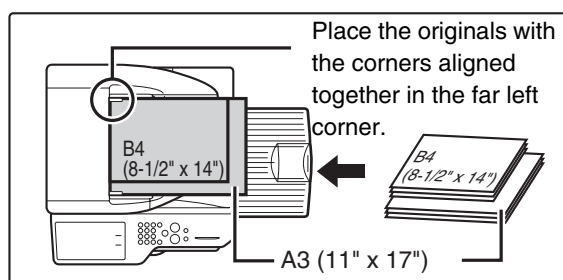

## Insert the originals face up in the document feeder tray.

Insert the originals with the corners aligned together in the far left corner of the document feeder tray.

2

## Enter the destination fax number.

[ENTERING DESTINATIONS](#) (page 4-17)

3

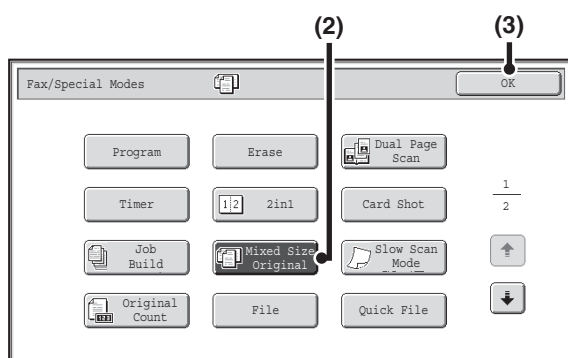

## Select the mixed size original setting.

- (1) Touch the [Special Modes] key.  
 [SPECIAL MODES](#) (page 4-72)
- (2) Touch the [Mixed Size Original] key so that it is highlighted.
- (3) Touch the [OK] key.



If an original scan size has been specified, a message will appear when the [Mixed Size Original] key is touched. To enable the Mixed Size Original setting, change the scan size setting to auto and then touch the [Mixed Size Original] key again.

4

**Press the [BLACK & WHITE START] key.**

Scanning begins. A beep will sound to indicate that scanning is finished.

---

**To cancel scanning...**

Press the [STOP] key (⏹).



- Once mixed size originals has been selected, an original scan size cannot be specified.
- When mixed size originals are set, automatic duplex scanning cannot be used.
- When the mixed size original setting is selected, rotation sending does not operate.

**To cancel the mixed size original setting...**

Touch the [Mixed Size Original] key in the screen of step 3 so that it is not highlighted.

**System Settings (Administrator): Original Feeding Mode**

The original feeding mode can be set to always scan mixed size originals.

# FAXING THIN ORIGINALS (Slow Scan Mode)

Use this function when you wish to scan thin originals using the automatic document feeder. This function helps prevent thin originals from misfeeding.

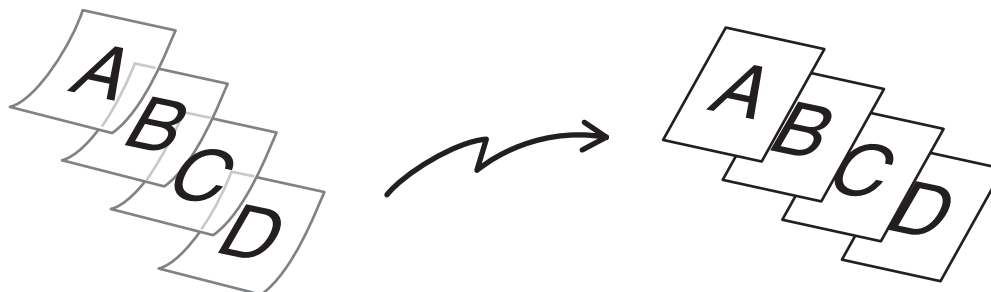

1

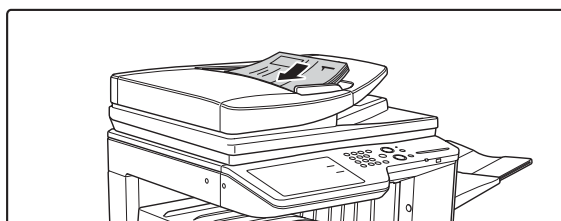

**Insert the originals face up in the document feeder tray.**

Adjust the document guides slowly.



If the originals are inserted with too much force, they may crumple and misfeed.

2

**Enter the destination fax number.**

 [ENTERING DESTINATIONS](#) (page 4-17)

3

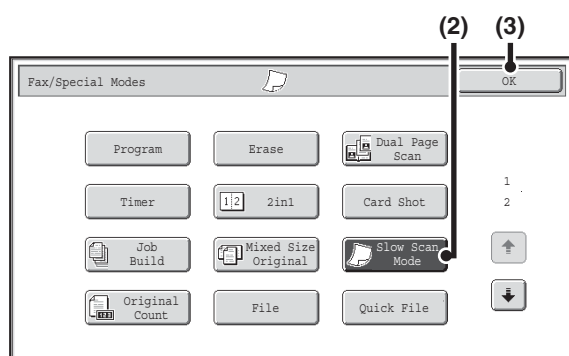

**Select slow scan mode.**

- (1) Touch the [Special Modes] key.  
 [SPECIAL MODES](#) (page 4-72)
- (2) Touch the [Slow Scan Mode] key so that it is highlighted.
- (3) Touch the [OK] key.

4

**Press the [BLACK & WHITE START] key.**

Scanning begins. A beep will sound to indicate that scanning is finished.

---

**To cancel scanning...**

Press the [STOP] key (⏹).



When this function is selected, automatic 2-sided scanning is not possible.

**To cancel slow scan mode...**

Touch the [Slow Scan Mode] key in the screen of step 3 so that it is not highlighted.

**System Settings (Administrator): Original Feeding Mode**

This is used to have scanning always take place using slow scan mode.

# CHECKING THE NUMBER OF SCANNED ORIGINAL SHEETS BEFORE TRANSMISSION (Original Count)

The number of scanned original sheets can be counted and displayed before transmission. Checking the number of scanned original sheets before transmission helps prevent transmission mistakes.

1

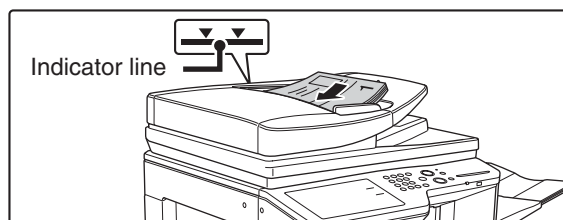

## Insert the originals face up in the document feeder tray.

Insert the originals all the way into the document feeder tray. Multiple originals can be placed in the document feeder tray. The stack of originals must not be higher than the indicator line on the tray.

2

## Enter the destination fax number.

➤ [ENTERING DESTINATIONS](#) (page 4-17)

3

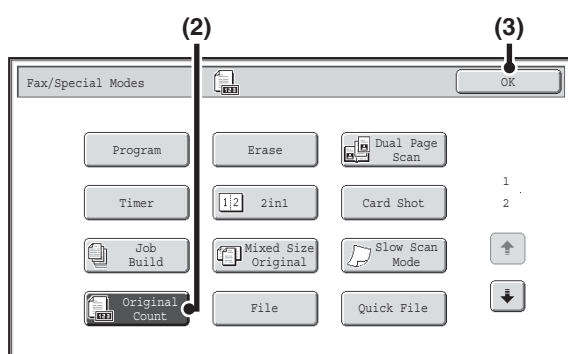

## Select the original count function.

- (1) Touch the [Special Modes] key.  
➤ [SPECIAL MODES](#) (page 4-72)
- (2) Touch the [Original Count] key so that it is highlighted.
- (3) Touch the [OK] key.

4

## Press the [BLACK & WHITE START] key.

Scanning begins.



### To cancel scanning...

Press the [STOP] key (⏹) to cancel the operation. All scanned data will be cleared.

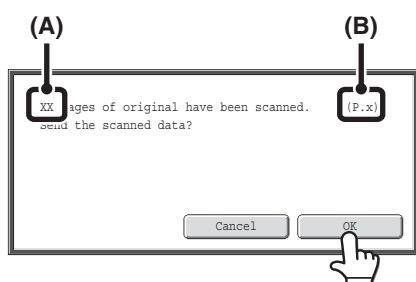

### When scanning ends, check the number of original sheets scanned and touch the [OK] key.

Transmission will begin.

- When Job Build mode is used, the confirmation message will appear after the [Read-End] key is touched.
- The message on the screen shows the number of sheets scanned in (A), and the number of pages (sheet sides) scanned in (B). For example, if both sides of one original sheet are scanned, "1" will appear in (A) and "2" will appear in (B).

- ✎ If this step is not performed for one minute while the above confirmation screen appears, the scanned image and settings will be cleared and the base screen will reappear. Scanning will not be completed automatically and the image will not be reserved for transmission.
- ↶ **If the displayed number of original sheets is different from the actual number of sheets...**  
Touch the [Cancel] key and then touch the [OK] key in the message screen to clear all scanned data. Scan settings and destination settings will not be cleared. Insert the original sheets in the automatic document feeder again and press the [BLACK & WHITE START] key to re-scan.

✎ When original count is enabled, it is enabled in other modes as well.

↶ **To cancel the Original Sheet Count function...**  
Touch the [Original Count] key in the screen of step 3 so that it is no longer highlighted.

⚙ **System Settings (Administrator): Initial Original Count Setting**  
This can be enabled to have the number of original sheets always counted. The setting can be enabled separately for each mode.

# STAMPING SCANNED ORIGINALS (Verif. Stamp)

This function stamps each original that is scanned using the automatic document feeder, allowing you to verify that all originals were correctly scanned.

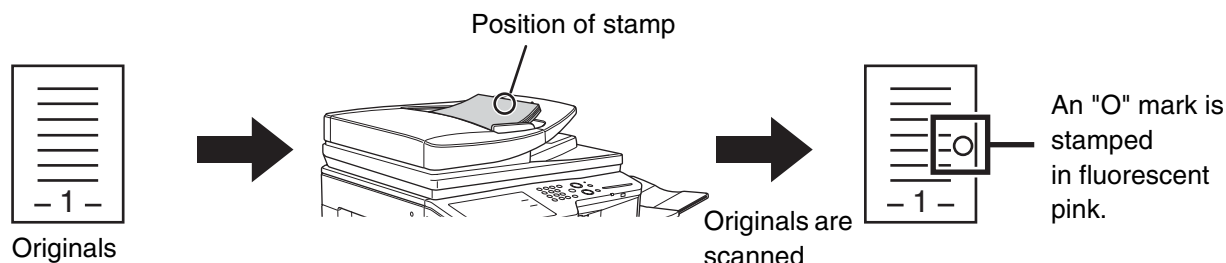

To use this function, the optional stamp unit must be installed.

1

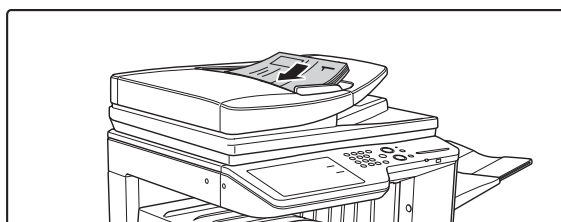

Insert the originals face up in the document feeder tray.

2

Enter the destination fax number.

[ENTERING DESTINATIONS](#) (page 4-17)

3

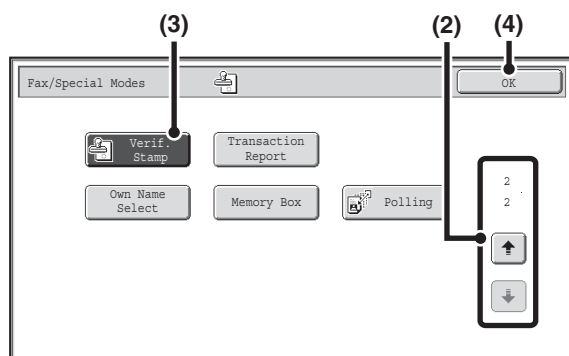

Select "Verif. Stamp".

- (1) Touch the [Special Modes] key.  
 [SPECIAL MODES](#) (page 4-72)
- (2) Touch the keys to switch through the screens.
- (3) Touch the [Verif. Stamp] key so that it is highlighted.
- (4) Touch the [OK] key.



4

**Press the [BLACK & WHITE START] key.**

Scanning begins. A beep will sound to indicate that scanning is finished.

**To cancel scanning...**

Press the [STOP] key () to cancel the operation.



- When two-sided originals are used, the front of each original is stamped twice.
- If an error occurs during scanning, an original that was not scanned may be stamped.
- When the "O" mark that is stamped on originals starts to become faint, replace the stamp cartridge. For the procedure for replacing the stamp cartridge, see "[REPLACING THE STAMP CARTRIDGE](#)" (page 1-69) in "1. BEFORE USING THE MACHINE".

**To cancel the stamp function...**

Touch the [Verif. Stamp] key in the screen of step 3 so that it is no longer highlighted.

**System Settings (Administrator): Default Verification Stamp**

This setting is used to always have originals stamped.

# CHANGING THE PRINT SETTINGS FOR THE TRANSACTION REPORT (Transaction Report)

A transaction report is automatically printed out to alert you when a transmission fails or when a broadcast transmission is performed. The transaction report contains a description of the transmission (date, start time, name of other party, time required, number of pages, result, etc.).

 [INFORMATION APPEARING IN THE RESULT COLUMN](#) (page 4-138)

Transaction reports are printed based on conditions set in the system settings; however, you can temporarily select different conditions for a transmission. To change the transaction report print conditions at the time of transmission, follow the steps below.

## 1 Place the original.

Place the original face up in the document feeder tray, or face down on the document glass.

## 2 Enter the destination fax number.

 [ENTERING DESTINATIONS](#) (page 4-17)

## Select the special modes.

(1) Touch the [Special Modes] key.

3 (2) Touch the   keys to switch through the screens.

(3) Touch the [Transaction Report] key.

 [SPECIAL MODES](#) (page 4-72)

## 4

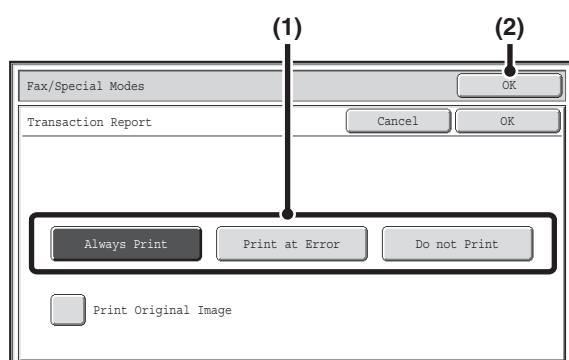

## Select print conditions.

(1) Select the print conditions.

(2) Touch the [OK] key.



- The print conditions for a transaction report are as follows:
  - "Always Print": A transaction report is printed no matter whether the transmission succeeds or fails.
  - "Print at Error": A transaction report is printed when transmission fails.
  - "Do not Print": Do not print a transaction report.
- When the [Print Original Image] checkbox is selected , part of the transmitted original is included on the transaction report.
- Even if the [Print Original Image] checkbox is selected , the original cannot be printed when speaker dialling, direct transmission, polling reception, or F-code transmission is used.

5

## Press the [BLACK & WHITE START] key.

Scanning begins.

- If you inserted the original pages in the document feeder tray, all pages are scanned.  
A beep will sound to indicate that scanning is finished.
- If you are scanning the original on the document glass, scan each page one page at a time.  
When scanning finishes, place the next original and press the [BLACK & WHITE START] key. Repeat until all pages have been scanned and then touch the [Read-End] key.  
A beep will sound to indicate that scanning is finished.



### To cancel scanning...

Press the [STOP] key (⏏) to cancel the operation.



For a broadcast transmission, changes to the transaction report print conditions apply to all destinations.



### To cancel the transaction report setting...

Touch the [Cancel] key in the screen of step 4.



#### • System Settings (Administrator): Transaction Report Print Select Setting

This is used to set the conditions for printing transaction reports.

The factory default setting is .

Single Sending: Print Out All Report//No Printed Report

Broadcasting: /Print Out Error Report Only/No Printed Report

Receiving: Print Out All Report/Print Out Error Report Only/

Confidential Reception (fax mode): /No Printed Report

#### • System Settings (Administrator): Original Print on Transaction Report

This is used to have part of the transmitted original printed on the transaction report.

# ADDING YOUR SENDER INFORMATION TO FAXES (Own number sending)

Your sender information (date, time, sender name, sender fax number, number of pages) is automatically added to the top of each fax page you transmit.

## Example of the sender information printed

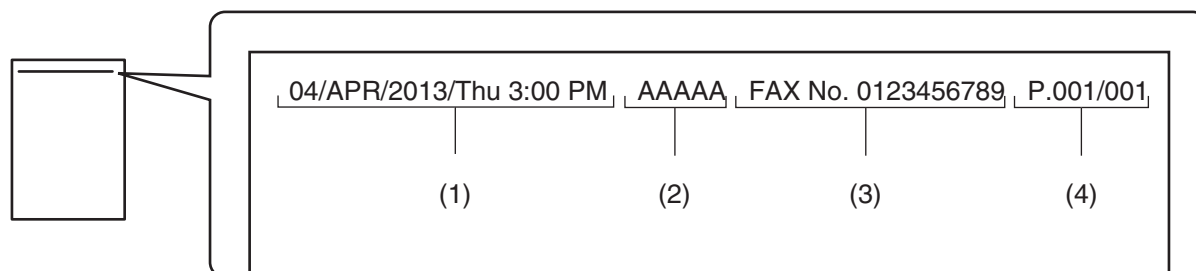

- (1) Date, time: The date and time of transmission.
- (2) Sender name: The sender name programmed in the machine.
- (3) Sender fax number: The sender fax number programmed in the machine.
- (4) Page numbers: Page number / total pages (the total page number is only printed when the fax is sent by memory transmission.)



### Information programmed in Own Number Sending

- Date, time: Adjust the setting in "Clock Adjust" in the system settings.
- Sender name, sender fax number: Program the sender name and fax number in "Sender Data Registration" in the system settings (administrator). If you intend to use own number sending, be sure to configure this information.
- Page numbers: Select whether or not to include page numbers in "Printing Page Number at Receiver" in the system settings (administrator).  
Page numbers appear in the format "page number / total pages". Only the page number is printed when manual transmission or quick online transmission is used.



### System Settings (Administrator): Date/Own Number Print Position Setting

This is used to set the position where the sender information is printed. The sender information can be printed outside the scanned original image or inside the scanned original image.

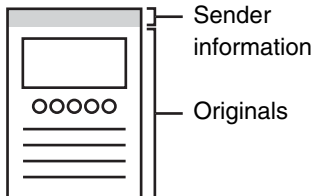
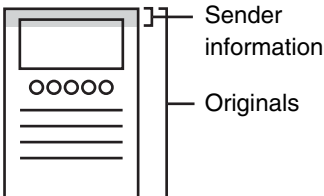

Outside scanned image (factory default setting)	Inside scanned image
 <p>The transmitted image length will be: length of sender information + length of original image. When the fax is printed by the receiving machine, it may be reduced or divided onto two pages.</p>	 <p>The sender information is printed inside the original image, and thus the transmitted image length is the length of the original. Note that the sender information will overlap part of the original image (the overlapped part of the original image will not appear).</p>

# TEMPORARILY CHANGING THE SENDER INFORMATION (Own Name Select)

You can select the sender information printed on a transmitted fax from a list of stored senders.

## Select the special modes.

1

- (1) Touch the [Special Modes] key.
- (2) Touch the   keys to switch through the screens.
- (3) Touch the [Own Name Select] key.

 [SPECIAL MODES](#) (page 4-72)

2

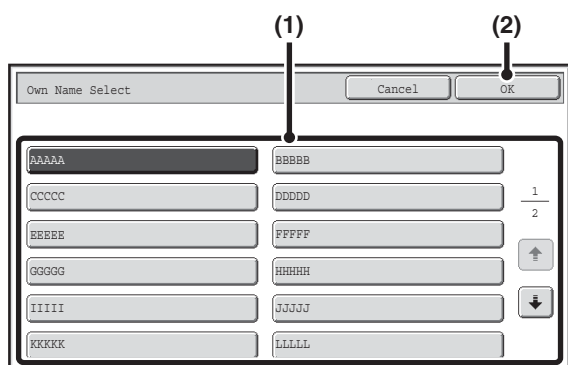

## Select the sender information.

- (1) Touch the desired sender information key.
- (2) Touch the [OK] key.

3

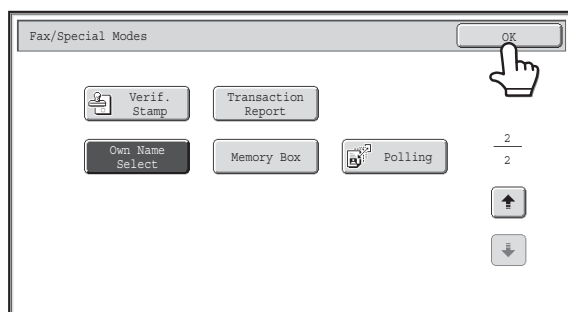

## Touch the [OK] key.



### System Settings (Administrator): Registration of Own Name Select

This is used to store sender information for Own Name Select.

# CALLING A FAX MACHINE AND INITIATING RECEPTION (Polling)

The Polling function allows the receiving machine to call the transmitting machine and initiate reception of a document in that machine.

Because the receiving machine initiates reception of a document, this is called "Polling Reception".

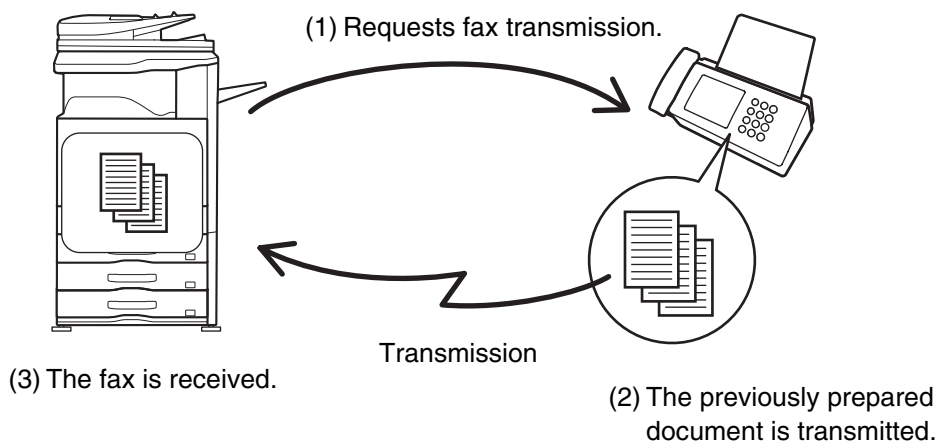

Make sure that an original is not placed in the machine when using the polling reception function.

1

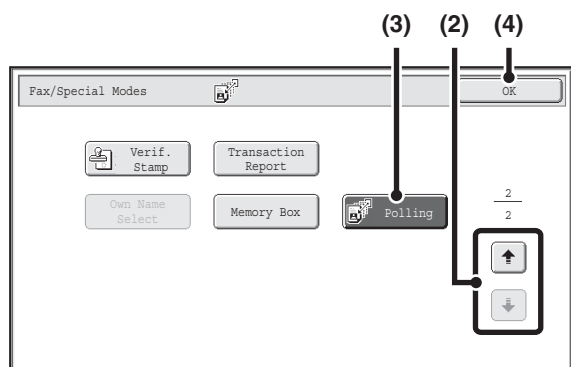

## Select polling reception.

- (1) Touch the [Special Modes] key.  
[SPECIAL MODES](#) (page 4-72)
- (2) Touch the keys to switch through the screens.
- (3) Touch the [Polling] key so that it is highlighted.
- (4) Touch the [OK] key.

2

## Enter the destination fax number.

[ENTERING DESTINATIONS](#) (page 4-17)



- **Multiple fax numbers can be entered.**  
 Polling will take place in the order that the numbers were entered.  
 Polling multiple machines is called "Serial Polling".  
 Up to 500 fax numbers can be entered. In this procedure, one-touch keys that have a sub-address and passcode cannot be used.
- To enter multiple fax numbers, touch the [Next Address] key after entering a fax number and enter the next fax number.

**3****Press the [BLACK & WHITE START] key.**

Your machine will call the other machine and initiate reception of the fax.



- Polling reception can be used in combination with the timer function to poll at any specified time, such as at night or when you are not present (Only one timer polling reception can be set.).
- This function can only be used when the other machine is Super G3 or G3 compatible and has a polling function.
- The receiving machine bears the expense (phone charges) of the polling reception.

**To cancel polling reception...**

Touch the [Polling] key in the screen of step 1 so that it is not highlighted.

# INITIATING POLLING RECEPTION MANUALLY

Use this procedure when you must start polling after listening to a recorded greeting, such as when using a fax information service.



- Make sure that an original is not placed in the machine when using the polling reception function.
- This function cannot be used to poll multiple machines (serial polling).

1

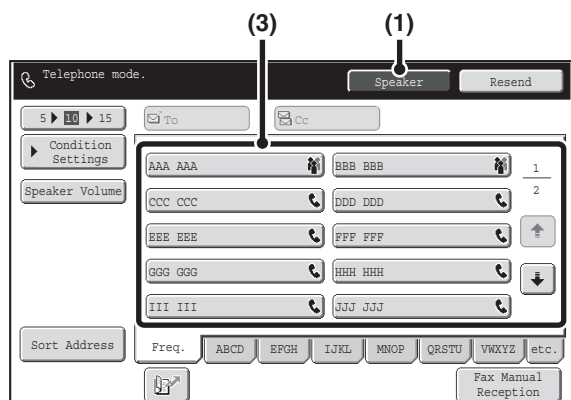

## Enter the destination fax number.

- Touch the [Speaker] key.**  
You will hear the dial tone through the machine's speaker.
- Touch the [Address Book] key in the base screen.**
- Touch the one-touch key of the desired destination.**  
A group key cannot be used.



- In addition to specification by one-touch key, a destination can also be specified using a search number. You can also directly enter a fax number with the numeric keys or look up a destination in a global address book. For more information, see "[ENTERING DESTINATIONS](#)" (page 4-17).
- After touching the [Speaker] key, you can touch the [Speaker Volume] key to adjust the volume of the speaker. The speaker volume changes each time the [Speaker Volume] key is touched. Adjust the volume to the desired level.

2

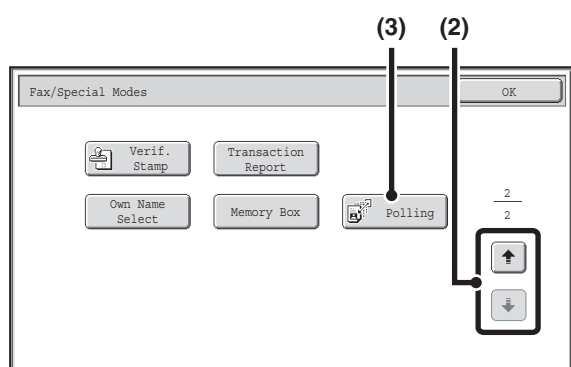

## Receive the fax.

- Touch the [Special Modes] key.**  
➡ [SPECIAL MODES](#) (page 4-72)
- Touch the keys to switch through the screens.**
- When you hear the fax tone, touch the [Polling] key.**  
The fax is received.



- This function can only be used when the other machine is Super G3 or G3 compatible and has a polling function.
- The receiving machine bears the expense (phone charges) of the polling reception.



# SENDING A FAX WHEN ANOTHER MACHINE POLLS YOUR MACHINE (Polling Memory)

Sending a document that has been scanned into memory when another machine polls your machine is called "Polling Memory".

Prior to polling, the document that will be faxed to the other machine must be scanned into a polling memory box. This function can only be used when the other machine is Super G3 or G3 compatible and has a polling function.

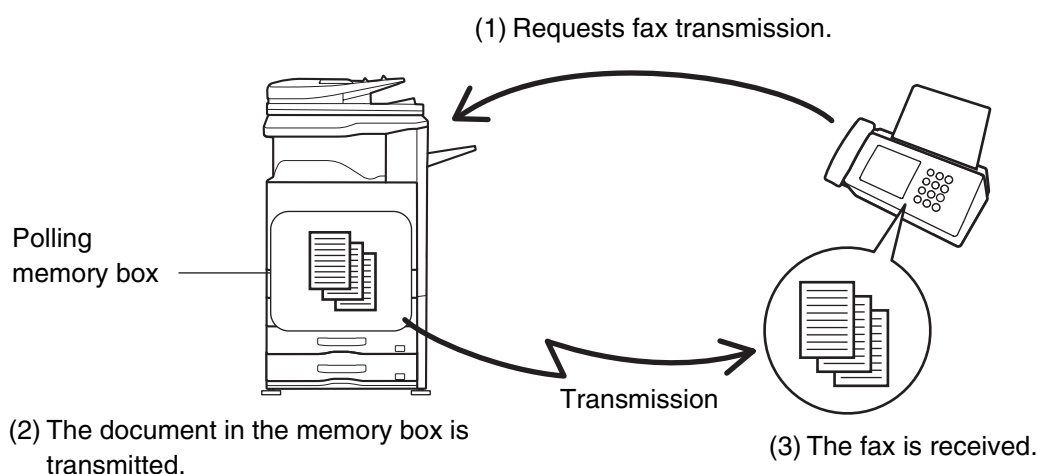

## RESTRICTING POLLING ACCESS (Polling security)

To only allow specified machines to poll your machine, you can restrict polling to machines whose programmed sender fax number matches a fax number stored in your machine as a polling passcode number. This is called "Polling Security".

To use this function, first store polling passcode numbers (the sender fax numbers programmed in the other machines) in the machine's system settings, and then enable polling security.

 Up to 10 fax numbers can be stored as polling passcode numbers.

 **System Settings (Administrator): Fax Polling Security**  
This is used to enable polling security. This is used to store fax numbers as polling passcode numbers.

# SCANNING A DOCUMENT INTO POLLING MEMORY

Follow these steps to scan a document into the memory box for polling transmission (Public Box).

## 1 Place the original.

Place the original face up in the document feeder tray, or face down on the document glass.

## 2 Select the special modes.

(1) Touch the [Special Modes] key.

2 (2) Touch the   keys to switch through the screens.

(3) Touch the [Memory Box] key.

 [SPECIAL MODES](#) (page 4-72)

3

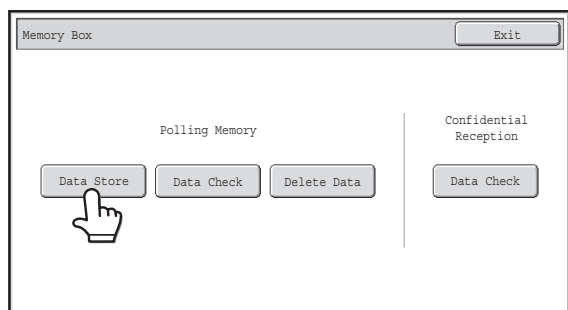

Touch the [Data Store] key.

4

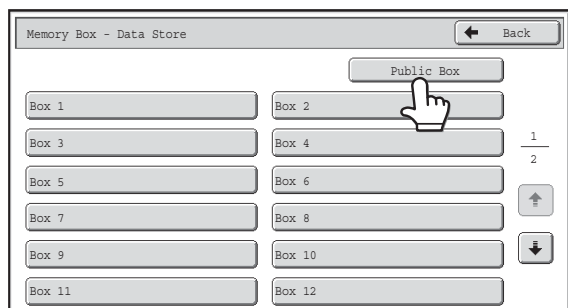

Touch the [Public Box] key.

5

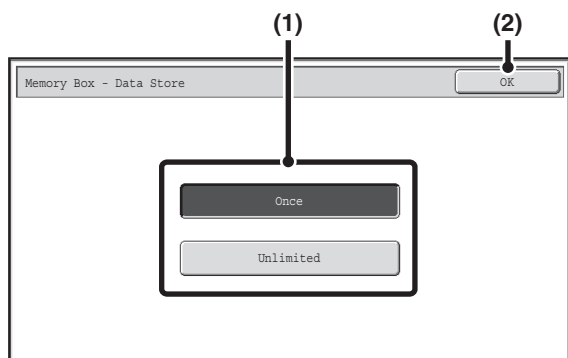

Specify the number of polling times.

(1) Touch the key for the desired number of times.

Touch the [Once] key if you want the document cleared from memory after it is transmitted. Touch the [Unlimited] key to allow polling an unlimited number of times.

(2) Touch the [OK] key.

6

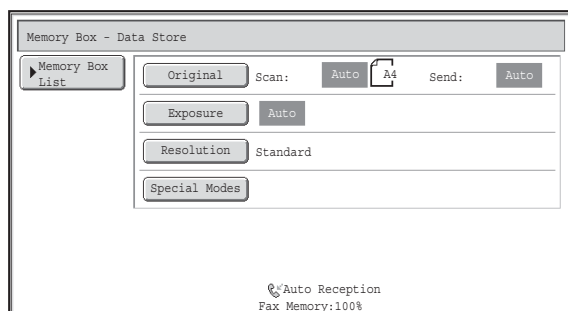

Select image settings and special modes.



- A program, timer setting, transaction report, polling, verif. stamp and document filing cannot be selected.
- To return to the screen of step 4, touch the [Memory Box List] key.

7

### Press the [BLACK & WHITE START] key.

Scanning begins.

- If you inserted the original pages in the document feeder tray, all pages are scanned.
  - If you are scanning the original on the document glass, scan each page one page at a time.
- When scanning finishes, place the next original and press the [BLACK & WHITE START] key. Repeat until all pages have been scanned and then touch the [Read-End] key.



#### To cancel scanning...

Press the [STOP] key (⏹) while the original is being scanned.





If another document remains in the memory box (Public Box), the newly scanned document is added to the previous document. In this case, the number of polling times will be the number set for the newly scanned document.

# CHECKING THE DOCUMENT IN THE PUBLIC BOX

You can check the document stored in the machine's public box for memory polling.

## Select the special modes.

1

- (1) Touch the [Special Modes] key.
- (2) Touch the   keys to switch through the screens.
- (3) Touch the [Memory Box] key.

 [SPECIAL MODES](#) (page 4-72)

2

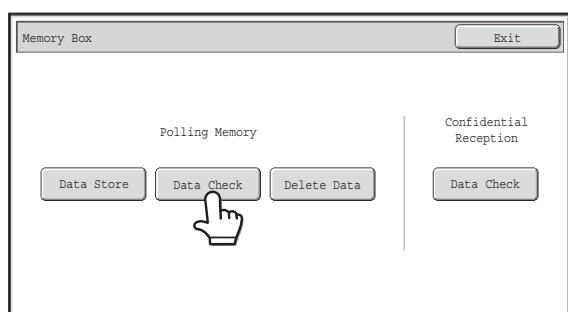

Touch the [Data Check] key.

3

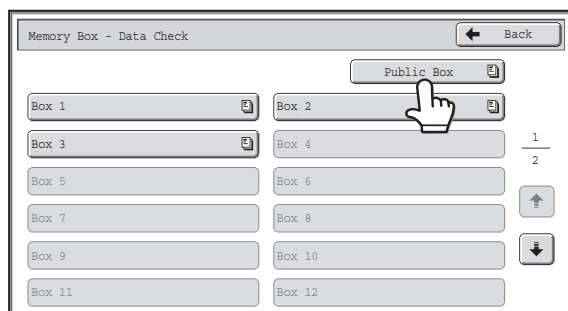

Touch the [Public Box] key.



When nothing is stored in the Public Box, the [Public Box] key will be greyed out.

4

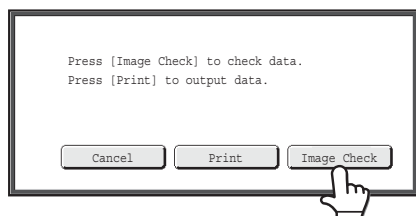

Touch the [Image Check] key.

The content of the document can be viewed in the image check screen. For information on the image check screen, see "[IMAGE CHECK SCREEN](#)" (page 4-66).



To print the document, touch the [Print] key.

# DELETING A DOCUMENT FROM THE PUBLIC BOX

Delete a document from the Public Box when it is no longer needed.

## Select the special modes.

1

- (1) Touch the [Special Modes] key.
  - (2) Touch the   keys to switch through the screens.
  - (3) Touch the [Memory Box] key.
-  [SPECIAL MODES](#) (page 4-72)

2

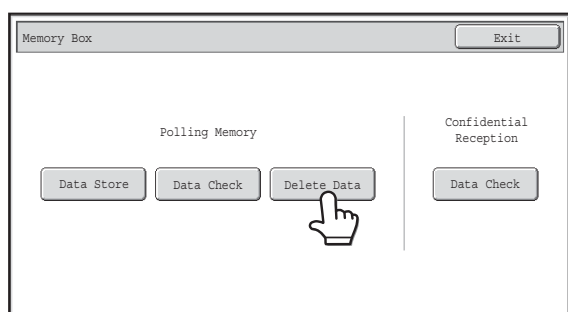

Touch the [Delete Data] key.

3

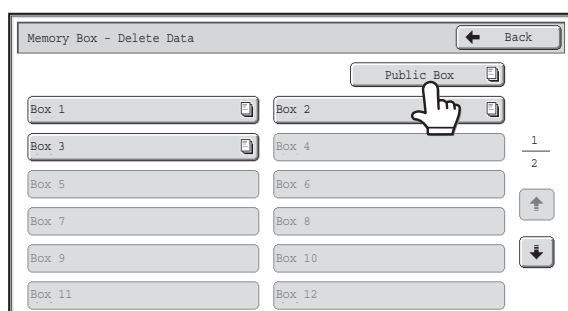

Touch the [Public Box] key.



When nothing is stored in the Public Box, the [Public Box] key will be greyed out.

4

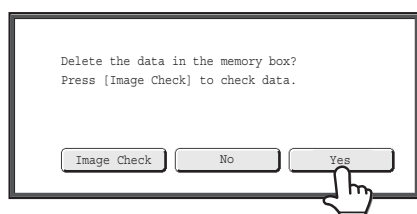

Touch the [Yes] key.

- The document is deleted and you return to the screen of step 3.
- You can touch the [Image Check] key to check the image in the touch panel before deleting it. For information on the image check screen, see "[IMAGE CHECK SCREEN](#)" (page 4-66).



### To cancel the deletion...

Touch the [No] key. You will return to the screen of step 3.

# PERFORMING F-CODE COMMUNICATION

This section explains how to perform F-code communication operations. F-code communication is possible with machines of other manufacturers that also support F-code communication.

## F-CODE COMMUNICATION

Exchange of confidential documents (confidential communication), retrieval (polling) and distribution (polling memory) of information, distribution of information to multiple destinations (relay broadcast transmission) are possible with other machines that support F-code communication.

An F-code\* is specified in each communication, enabling a higher level of security.

\* F-code is a communication function based on the G3 standard of the ITU-T.

 The ITU-T is a United Nations organization that establishes communications standards. It is a department of the International Telecommunication Union (ITU), which coordinates global telecommunications networks and services.

## HOW F-CODES WORK

A fax that is transmitted with an F-code is received to the memory box in the receiving machine specified by the F-code (sub-address and passcode). If the F-code sent by the transmitting machine does not match the F-code in the receiving machine, reception will not take place.

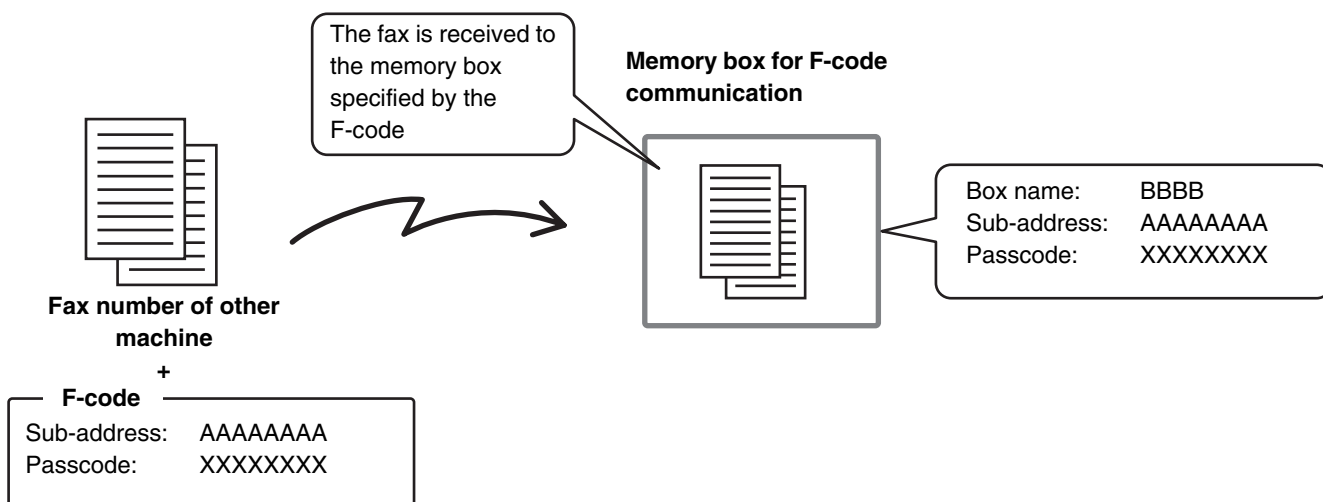

The products of other manufacturers may use different terms for "sub-address" and "passcode". If you need to contact the operator of another machine regarding sub-addresses and passcodes, refer to the terms used by the ITU-T in the table below.

The machine	ITU-T		
	F-code polling memory box	F-code confidential box	F-code relay broadcast memory box
Sub Address	SEP	SUB	SUB
Passcode	PWD	SID	SID

 An F-code consists of a sub-address and passcode, and cannot be longer than 20 digits.

# CREATING MEMORY BOXES IN THE MACHINE FOR F-CODE COMMUNICATION

Before the F-code communication function can be used, special memory boxes must be created using "F-Code Memory Box" in the system settings.

A box name and F-code (sub-address and passcode) are programmed in each box, and an F-code communication function is assigned to each box.

After you have created a memory box, inform the other party of the sub-address and passcode of the box.

## Memory box for F-code communication



- Box Name
- Sub Address
- Passcode
- End receiving machines (only in an F-code relay broadcast memory box)
- Print PIN (only for F-code confidential reception)

To use the following F-code communication functions, F-code memory boxes must be created in your machine.

F-code confidential reception, F-code polling memory, F-code relay broadcast transmission

To use the following F-code communication functions, F-code memory boxes must be created in the other machine.

F-code confidential transmission, F-code polling reception, F-code relay request transmission



### System Settings: [F-Code Memory Box](#) (page 7-107)

This is used to configure memory boxes for F-code communication.

- Up to 100 memory boxes can be created.
- The memory box name cannot be longer than 18 characters, and the sub-address and passcode cannot be longer than 20 digits.

## F-CODE DIALLING

When performing an F-code operation, the F-code (sub-address and passcode) is appended to the fax number that is dialled. Check the F-code (sub-address and passcode) programmed in the memory box in the other machine before you perform an F-code transmission. It is convenient to store an F-code together with the fax number in a one-touch key or group key.

0123456789 / AAAAAAAAAA / XXXXXXXX  
 Fax number of other machine \* Sub Address \* Passcode

\* Touch the [Sub Address] key in the screen to enter "/".

When the following F-code functions are used, your machine dials the other machine.

F-code confidential transmission, F-code polling reception, F-code relay request transmission

When the following F-code functions are used, the other machine dials your machine.

F-code confidential reception, F-code polling memory, F-code relay broadcast transmission



- If the destination machine does not have a passcode configured in the F-code, do not enter a passcode when dialling that machine.
- F-code communication cannot be performed when using the speaker or performing manual transmission.



### System Settings: [Address Book](#) (page 7-16)

This is used to store and edit one-touch keys and group keys.

# CONFIDENTIAL COMMUNICATION USING F-CODES

By sending a fax to an F-code memory box (confidential) in the receiving machine (your machine or the other machine), the sender can direct the transmission specifically to the user of the box.

This is convenient for sending sensitive documents that you do not wish people other than the recipient to see, or when the receiving machine is shared by multiple departments.

To print an F-code confidential fax, the print passcode must be entered.

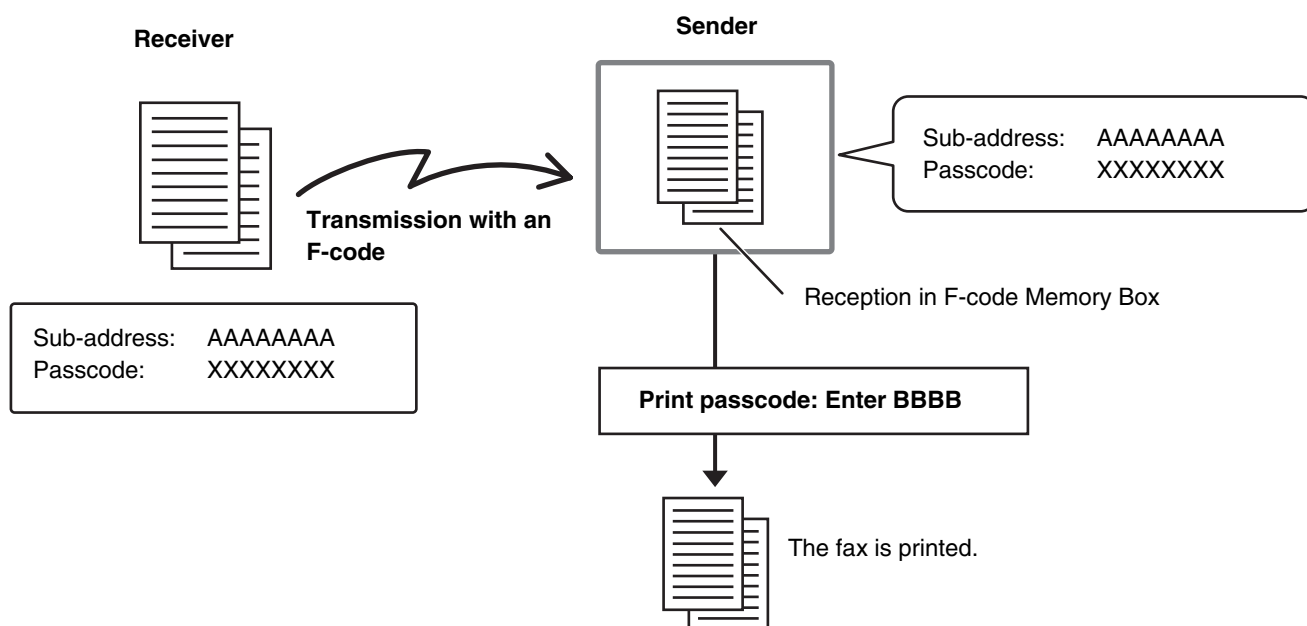

 The F-code (sub-address and passcode) of the memory box to be used should be verified by the sender and the recipient before the fax is sent.

 **System Settings: F-Code Memory Box (page 7-107)**  
This is used to create memory boxes for F-code confidential communication (confidential reception). A memory box name, sub-address, passcode, and print passcode are programmed in each box.



# F-CODE CONFIDENTIAL TRANSMISSION

Follow the steps below to send a confidential fax by adding an F-code to the fax number.

## 1 Place the original.

Place the original face up in the document feeder tray, or face down on the document glass.

## 2

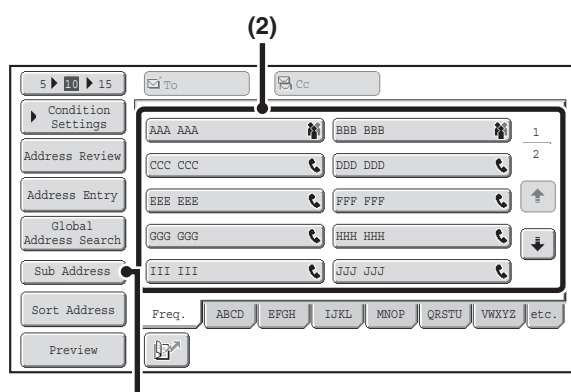

## Enter the destination fax number.

(1) Touch the [Address Book] key in the base screen.

(2) Touch the one-touch key of the desired destination.

If the destination is not stored in the address book, enter the fax number with the numeric keys.

If the sub-address and passcode are stored in the one-touch key, the following sub-steps are not necessary. Go to step 3.

(3) Touch the [Sub Address] key.

"/" appears.

(4) Enter the sub-address with the numeric keys.

(5) Touch the [Sub Address] key.

"/" appears.

(6) Enter the passcode with the numeric keys.



If a passcode has been omitted in the memory box of the other machine, (5) and (6) are not necessary.

## 3

## Press the [BLACK & WHITE START] key.

Scanning begins.

- If you inserted the original pages in the document feeder tray, all pages are scanned. A beep will sound to indicate that scanning is finished.
- If you are scanning the original on the document glass, scan each page one page at a time. When scanning finishes, place the next original and press the [BLACK & WHITE START] key. Repeat until all pages have been scanned and then touch the [Read-End] key. A beep will sound to indicate that scanning is finished.



This function can be used in combination with a broadcast transmission or timer transmission. This function can also be stored in a program.

# CHECKING FAXES RECEIVED BY F-CODE CONFIDENTIAL RECEPTION

When an F-code confidential fax is sent to your machine, the fax is received to the memory box specified by the F-code. To check received faxes, enter the print passcode.

1

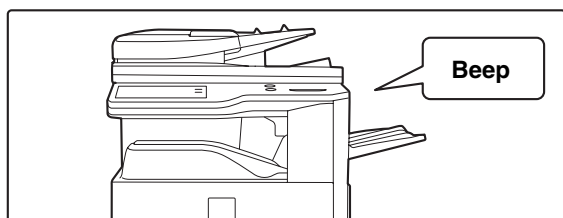

**The machine rings and the fax is received.**

A beep sounds when reception ends.

2

**Select the special modes.**

(1) Touch the [Special Modes] key.

(2) Touch the   keys to switch through the screens.

(3) Touch the [Memory Box] key.

 [SPECIAL MODES](#) (page 4-72)

3

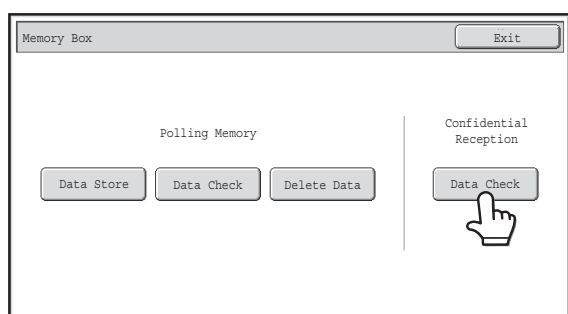

**Touch the [Data Check] key.**

4

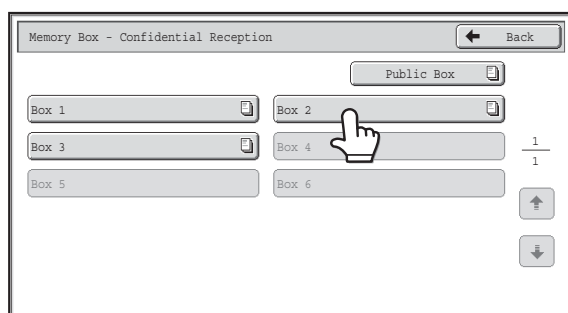

**Touch the key of the memory box containing the confidential fax.**

"" appears in the keys of memory boxes that have received faxes. The keys of memory boxes that have not received faxes are greyed out and cannot be selected.

5

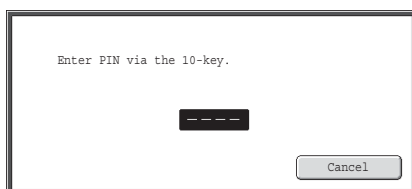

### Enter the print passcode with the numeric keys.

As each digit is entered, "-" changes to "\*".



Take care to enter the correct print passcode. If you make a mistake, a message will appear and you will return to the entry screen. You can touch the [Cancel] key to return to step 4.

6

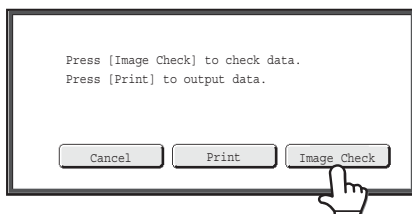

### Touch the [Image Check] key.

The content of the document can be viewed in the image check screen. For information on the image check screen, see "[IMAGE CHECK SCREEN](#)" (page 4-66).

To print the document, touch the [Print] key.



- The confidential fax is automatically given priority in the print job queue.
- The fax is automatically cleared from the memory box after printing.

• **If you forget the print passcode...**

There is no way to check a forgotten passcode on the machine. Take care not to forget the passcode. In the event that you forget the passcode or need to verify the passcode, contact your dealer or nearest authorised service representative.



**System Settings (Administrator): Transaction Report Print Select Setting**

This setting can be used to have a transaction report printed automatically when an F-code confidential fax is received.

# POLLING RECEPTION USING F-CODES

This function enables your machine to call another machine and initiate reception of a fax stored in an F-code memory box (polling memory) in the other machine. During the polling operation, your machine must correctly specify the F-code (sub-address and passcode) configured in the other machine or polling reception will not take place.

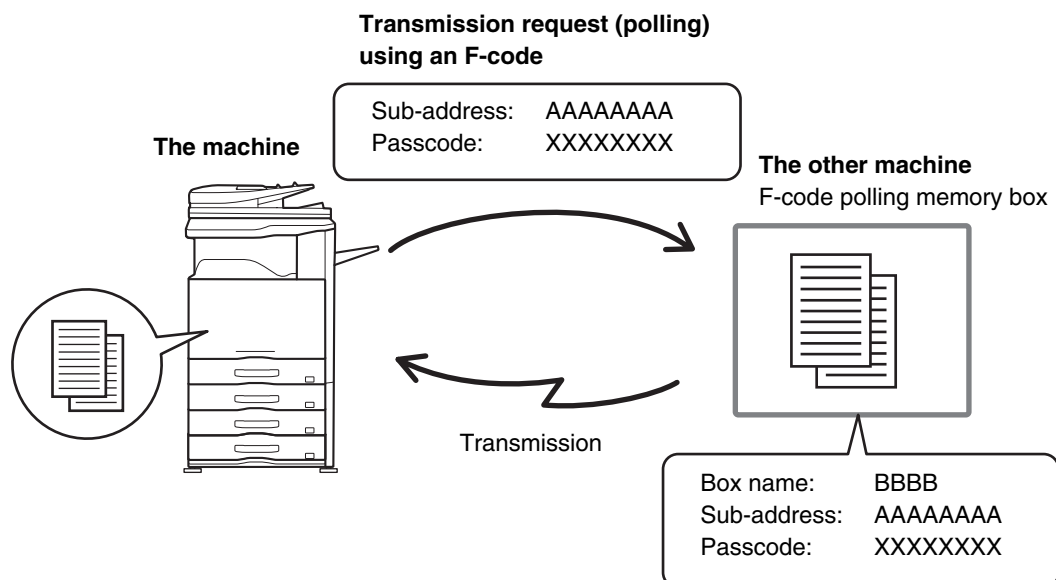

- Verify the F-code (sub-address and passcode) of the memory box in the other machine before you perform F-code polling reception.
- Do not place an original in the automatic document feeder or on the document glass when using this function.
- The receiving machine bears the phone charges of the transmission.

1

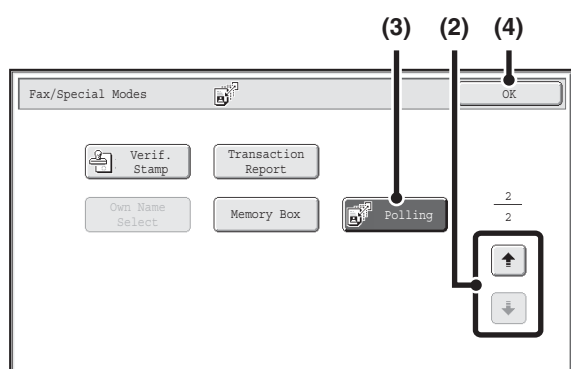

## Select polling.

- (1) Touch the [Special Modes] key.  
[SPECIAL MODES](#) (page 4-72)
- (2) Touch the keys to switch through the screens.
- (3) Touch the [Polling] key so that it is highlight.
- (4) Touch the [OK] key.

2

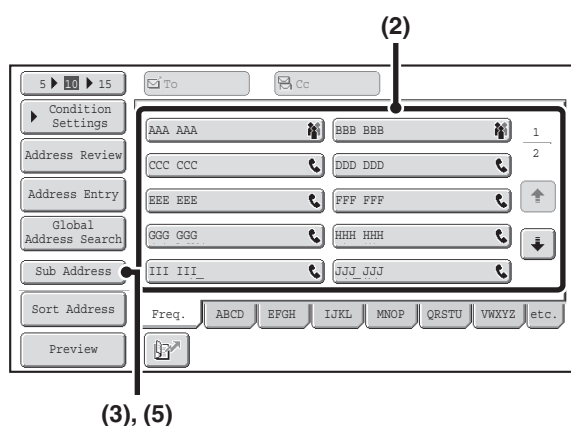

(3), (5)

### Enter the destination fax number.

- (1) Touch the [Address Book] key in the base screen.
- (2) Touch the one-touch key of the desired destination.

If the destination is not stored in the address book, enter the fax number with the numeric keys.

If the sub-address and passcode are stored in the one-touch key, the following sub-steps are not necessary. Go to step 3.

- (3) Touch the [Sub Address] key.  
"/" appears.
- (4) Enter the sub-address with the numeric keys.
- (5) Touch the [Sub Address] key.  
"/" appears.
- (6) Enter the passcode with the numeric keys.



If a passcode has been omitted in the memory box of the other machine, (5) and (6) are not necessary.

3

### Press the [BLACK & WHITE START] key.

Your machine will call the other machine and initiate reception of the fax.



- Polling multiple machines (serial polling) is not possible.
  - F-code polling reception can be used in combination with a timer setting. Only one polling reception operation with a timer setting can be stored at a time.
- [SENDING A FAX AT A SPECIFIED TIME \(Timer\)](#) (page 4-80)



#### To cancel polling...

Touch the [Polling] key in the screen of step 1 so that it is not highlighted.

# POLLING MEMORY TRANSMISSION USING F-CODES

When your machine receives a transmission request from another machine, this function sends a fax stored in an F-code memory box (polling memory) in your machine to that machine. The other machine must correctly specify the F-code configured in your machine or transmission will not take place.

The document to be transmitted must be scanned into an F-code polling memory box.

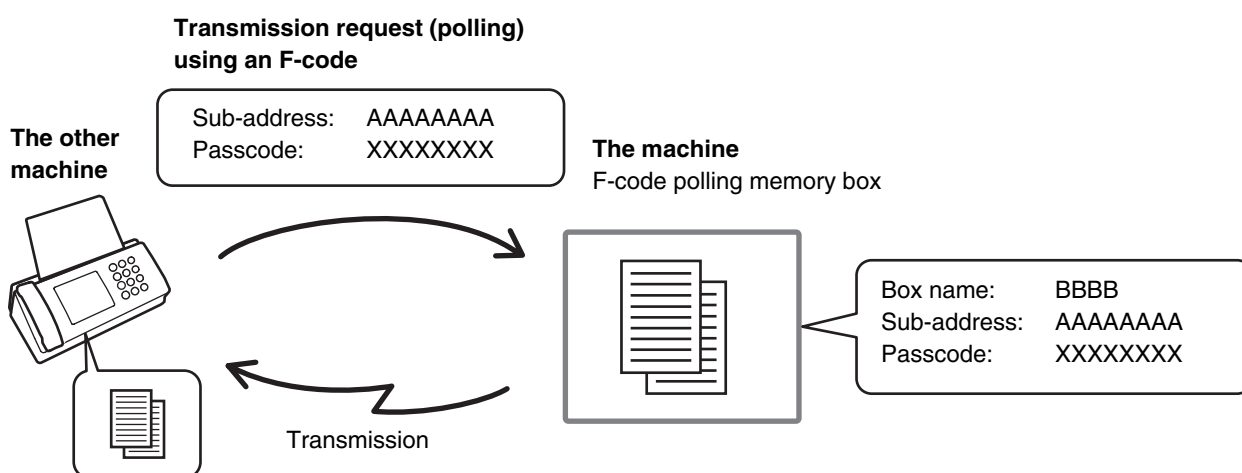

## System Settings: [F-Code Memory Box](#) (page 7-107)

This is used to create memory boxes (polling memory) for F-code polling memory transmission. A memory box name, sub-address, and passcode are programmed in each box.

## SCANNING A DOCUMENT INTO A MEMORY BOX FOR F-CODE POLLING TRANSMISSION

Follow these steps to scan a document into a memory box (polling memory) for F-code polling transmission.

### 1

#### Place the original.

Place the original face up in the document feeder tray, or face down on the document glass.

### 2

#### Select the special modes.

(1) Touch the [Special Modes] key.

(2) Touch the keys to switch through the screens.

(3) Touch the [Memory Box] key.

[SPECIAL MODES](#) (page 4-72)

3

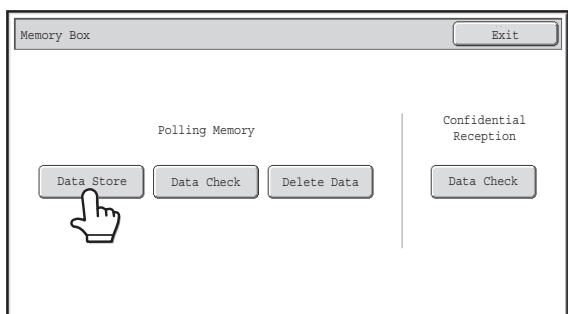

Touch the [Data Store] key.

4

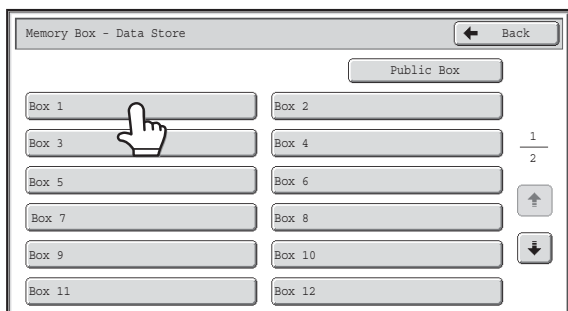

Touch the key of the F-code memory polling box.

5

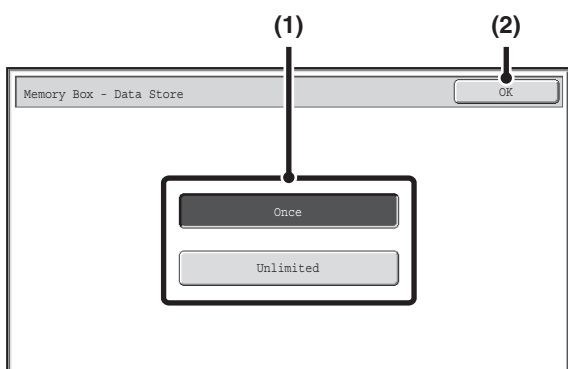

Specify the number of polling times.

(1) Touch the key for the desired number of times.

Touch the [Once] key if you want the document cleared from memory after it is transmitted. Touch the [Unlimited] key to allow polling an unlimited number of times.

(2) Touch the [OK] key.

6

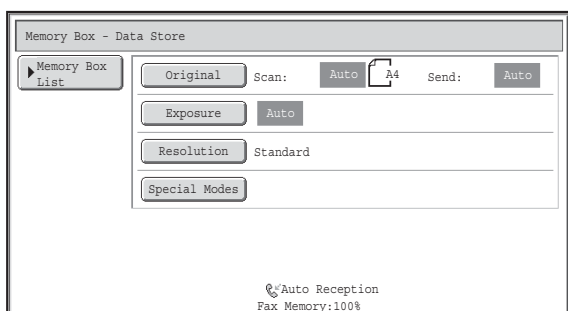

Select image settings and special modes.



- A program, timer setting, transaction report, polling, verif. stamp and document filing cannot be selected.
- To return to the screen of step 4, touch the [Memory Box List] key.

7

**Press the [BLACK & WHITE START] key.**

Scanning begins.

- If you inserted the original pages in the document feeder tray, all pages are scanned.
- If you are scanning the original on the document glass, scan each page one page at a time.

When scanning finishes, place the next original and press the [BLACK & WHITE START] key. Repeat until all pages have been scanned and then touch the [Read-End] key.

---

**To cancel scanning...**

Press the [STOP] key (⏹) while the original is being scanned.



- If other documents have already been stored in the memory box, the document is added to the previously stored documents.
- The factory default setting for the number of polling times is "Once" (after the document is transmitted to the receiving machine, it is automatically cleared).



# CHECKING THE DOCUMENT IN THE F-CODE MEMORY POLLING BOX



You can check the document stored in the F-code memory polling box.



A document in a memory box cannot be printed while the document is being transmitted.

## Select the special modes.

1

- (1) Touch the [Special Modes] key.
  - (2) Touch the   keys to switch through the screens.
  - (3) Touch the [Memory Box] key.
-  [SPECIAL MODES](#) (page 4-72)

2

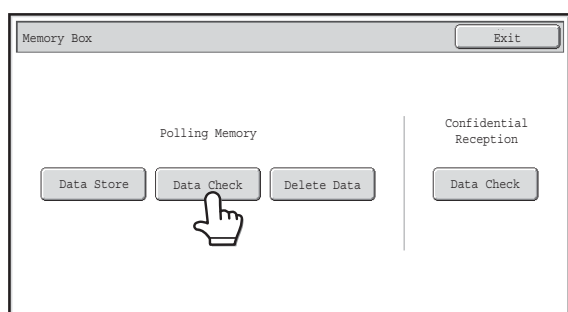

Touch the [Data Check] key.

3

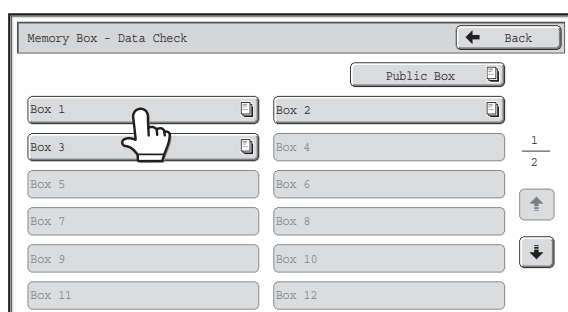

Touch the key of the F-code memory polling box where the document you wish to print is stored.

 appears in keys that have documents stored.

4

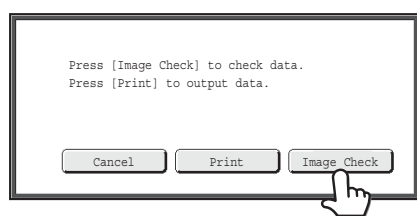

Touch the [Image Check] key.

The content of the document can be viewed in the image check screen. For information on the image check screen, see "[IMAGE CHECK SCREEN](#)" (page 4-66).

To print the document, touch the [Print] key.

# DELETING A DOCUMENT STORED FOR F-CODE POLLING TRANSMISSION



When a document in an F-code memory polling box is no longer needed, follow the steps below to delete it.



A document in a memory box cannot be deleted while the document is being transmitted.

## Select the special modes.

1

- (1) Touch the [Special Modes] key.
  - (2) Touch the   keys to switch through the screens.
  - (3) Touch the [Memory Box] key.
-  [SPECIAL MODES](#) (page 4-72)

2

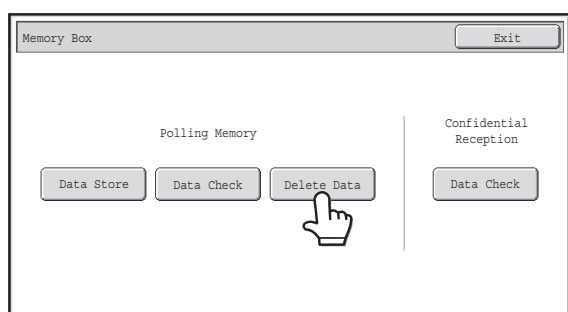

Touch the [Delete Data] key.

3

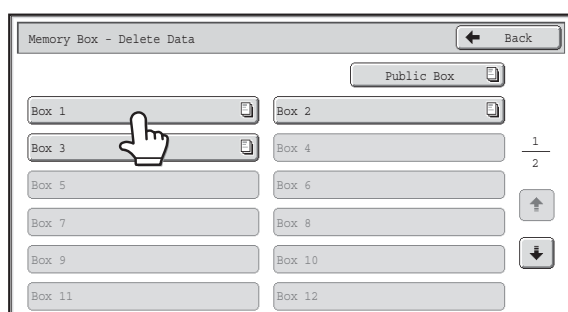

Touch the key of the F-code memory polling box that has the document you wish to delete.

 appears in keys that have documents stored.

4

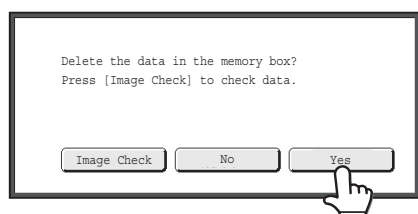

Touch the [Yes] key.

- The document is deleted and you return to the screen of step 3.
- Printing will begin.

You can touch the [Image Check] key to check the image in the touch panel before deleting it. For information on the image check screen, see "[IMAGE CHECK SCREEN](#)" (page 4-66).



### To cancel the deletion...

Touch the [No] key. You will return to the screen of step 3 without deleting the document.

# RELAY REQUEST TRANSMISSION USING F-CODES

This function is used to send a fax to an F-code relay broadcast memory box in another machine and have that machine relay the fax to multiple end receiving machines.

When the end receiving machines are far from your machine, sending the fax to a relay machine that is close to the end receiving machines can help reduce phone charges. A relay request transmission can be used in combination with the timer transmission function to further reduce phone costs.

 [SENDING A FAX AT A SPECIFIED TIME \(Timer\)](#) (page 4-80)

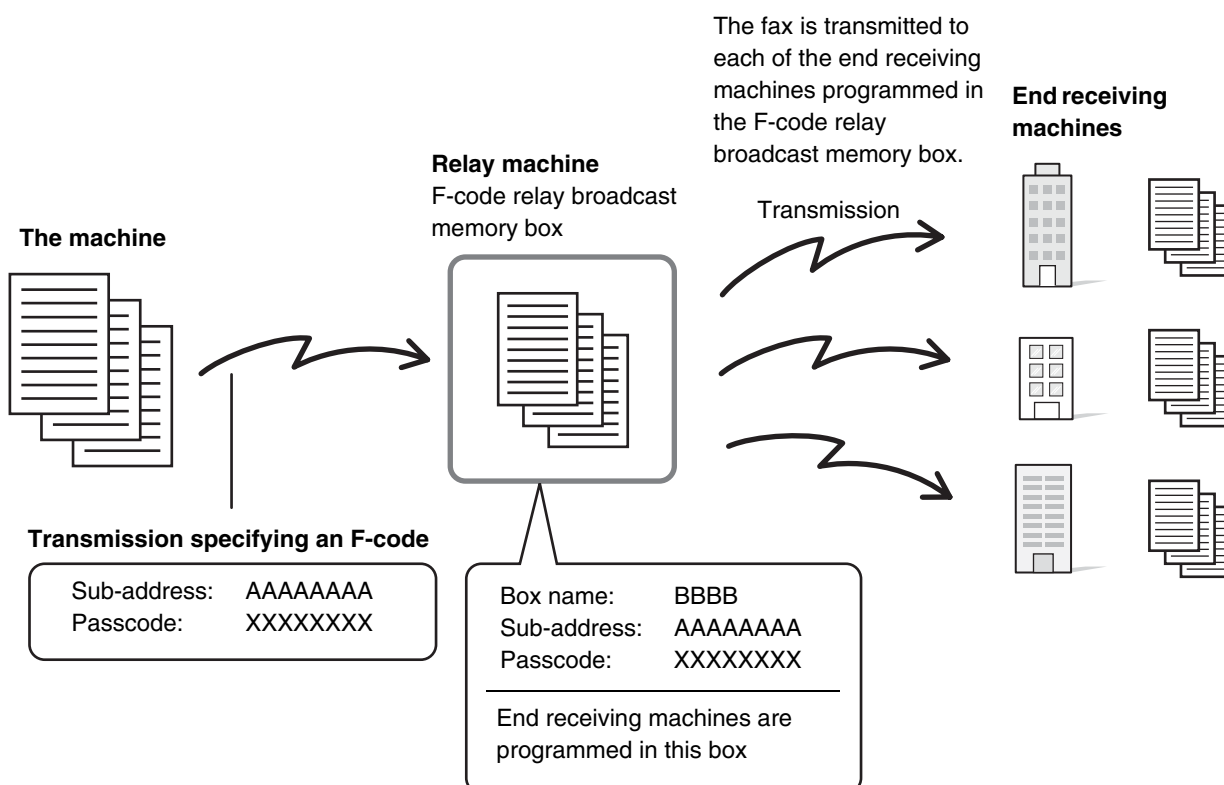

- Verify the F-code (sub-address and passcode) and end receiving machines programmed in the relay broadcast memory box in the relay machine before you perform an F-code relay request transmission.
- Before this function can be used, the end receiving machines must be programmed in the F-code relay broadcast memory box in the relay machine.
- The end receiving machines do not need to support F-code communication.
- This function can be used in combination with a broadcast transmission or timer transmission. An F-code relay request transmission can also be stored in a program.
- Your machine (the machine that requests a relay broadcast transmission) only bears the cost of sending the fax to the relay machine. The relay machine bears the cost of sending the fax to each of the end receiving machines.
- When faxes forwarded using this function are printed at the forwarding destination, the date and time of reception cannot be printed on the faxes. ("Receiving Date & Time Print" is disabled.)



## System Settings: [F-Code Memory Box](#) (page 7-107)

This is used to create memory boxes for F-code relay broadcast transmission.

A memory box name, sub-address, passcode, and end receiving machines are programmed in each box.

1

## Place the original.

Place the original face up in the document feeder tray, or face down on the document glass.

2

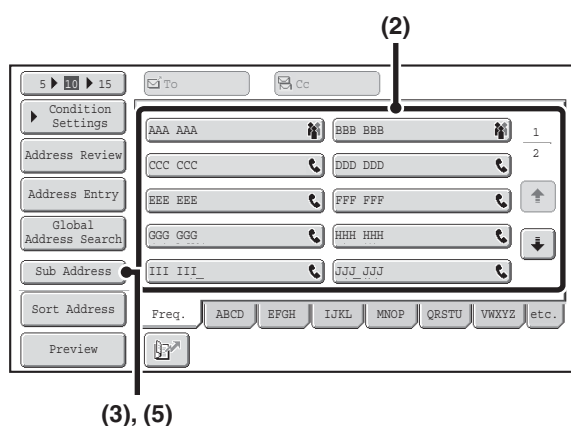

## Enter the destination fax number.

- (1) Touch the [Address Book] key in the base screen.
- (2) Touch the one-touch key of the desired destination.

If the destination is not stored in the address book, enter the fax number with the numeric keys.

If the sub-address and passcode are stored in the one-touch key, the following sub-steps are not necessary. Go to step 3.

- (3) Touch the [Sub Address] key.  
"/" appears.
- (4) Enter the sub-address with the numeric keys.
- (5) Touch the [Sub Address] key.  
"/" appears.
- (6) Enter the passcode with the numeric keys.



If a passcode has been omitted in the memory box of the other machine, (5) and (6) are not necessary.

3

## Press the [BLACK & WHITE START] key.

Scanning begins.

- If you inserted the original pages in the document feeder tray, all pages are scanned.  
A beep will sound to indicate that scanning is finished.
- If you are scanning the original on the document glass, scan each page one page at a time.  
When scanning finishes, place the next original and press the [BLACK & WHITE START] key. Repeat until all pages have been scanned and then touch the [Read-End] key.  
A beep will sound to indicate that scanning is finished.

When the relay machine receives the fax, it will automatically transmit the fax to each of the end receiving machines programmed in the memory box.



### To cancel scanning...

Press the [STOP] key (⏹) while the original is being scanned.

# RELAY BROADCAST TRANSMISSION USING F-CODES

When your machine receives an F-code relay request transmission, the fax is received to an F-code relay broadcast memory box in your machine. Your machine then relays the fax to each of the end receiving machines programmed in the memory box. Transmission to the end receiving machines takes place automatically.

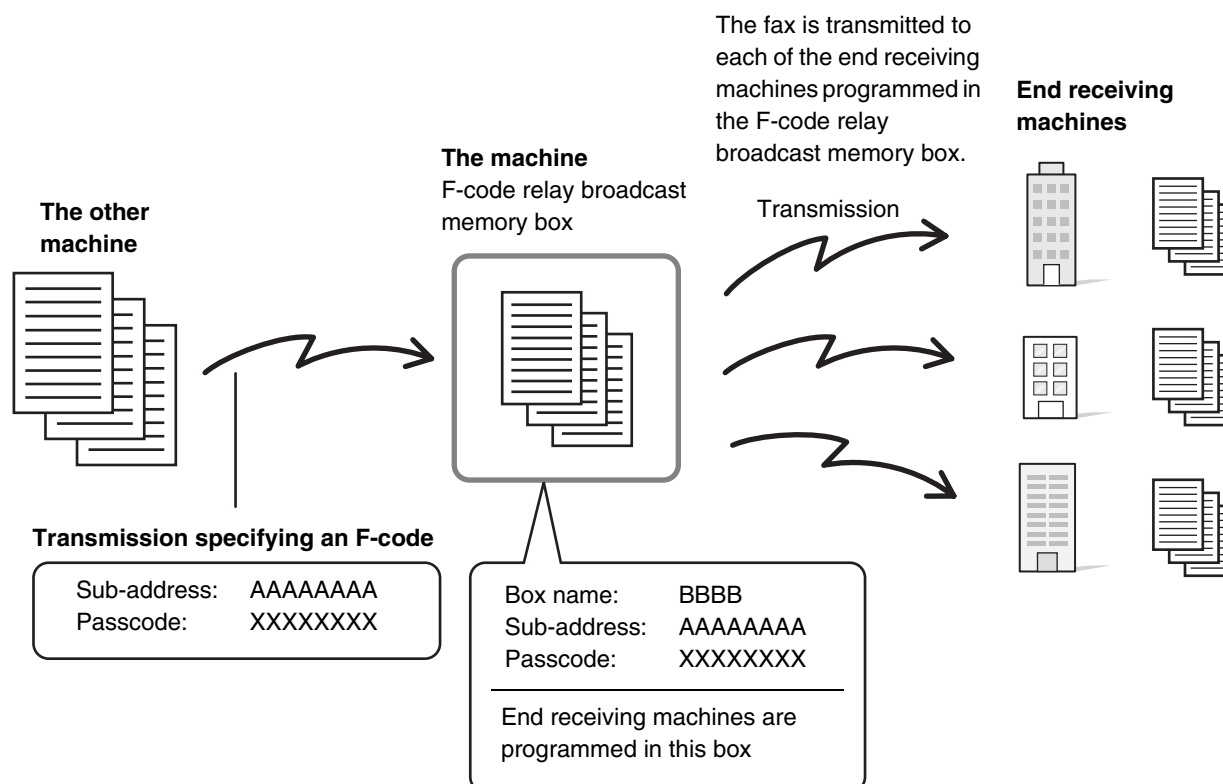

- Prior to the operation, inform the requesting party of the sub-address and passcode of the relay broadcast memory box in your machine.
- Program the end receiving machines in the F-code relay broadcast memory box when you create the box in your machine. [CREATING MEMORY BOXES IN THE MACHINE FOR F-CODE COMMUNICATION](#) (page 4-111)
- The end receiving machines do not need to support F-code communication.
- The machine that requests a relay broadcast transmission only bears the cost of sending the fax to your machine (the relay machine). Your machine bears the cost of sending the fax to each of the end receiving machines.
- When faxes forwarded using this function are printed at the forwarding destination, the date and time of reception cannot be printed on the faxes. ("Receiving Date & Time Print" is disabled.)

# USING AN EXTENSION PHONE

This section explains how to use an extension phone to make voice calls and receive a fax after talking with the other party.

## CONNECTING AND USING AN EXISTING PHONE (Extension Phone Connection)

You can connect an existing extension phone to the machine.

The phone can be used for voice calls and to start fax reception on the machine.

As an example, you can make a phone call using the existing phone, speak to the other party, and then press the [BLACK & WHITE START] key to fax an original that has been placed to that party. You can also press the [BLACK & WHITE START] key when an original is not placed to receive a fax.

Connect the extension phone as shown below.

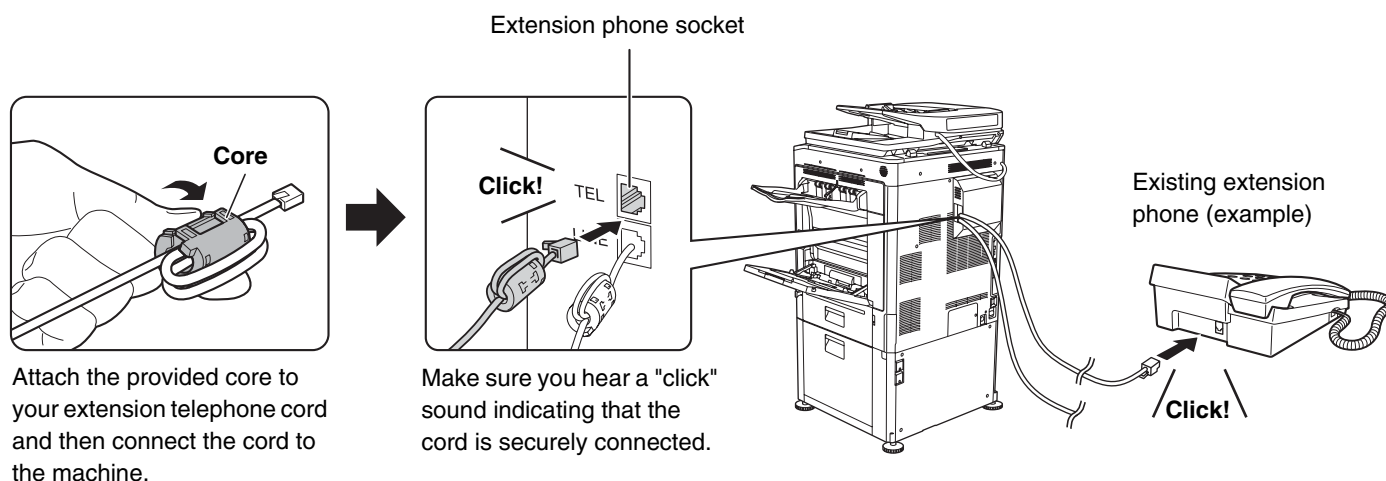

- Connect an extension phone that has a modular socket. Use standard phone line cable to connect the phone. If other than a standard phone line cable is used, the connection may not work correctly.
- If the plug on the telephone line cord does not fit into the socket on your extension phone, contact your dealer or nearest authorised service representative.

## RECEIVING A FAX AFTER ANSWERING A CALL ON THE EXTENSION PHONE (Remote Reception)

Follow the steps below if you need to start fax reception after answering a call and speaking on the extension phone. If you are on a pulse-dial (rotary) line, set the extension phone to issue tone signals.

1

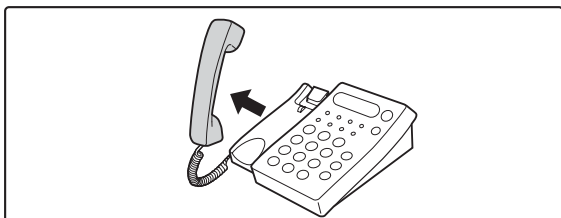

**When you hear ringing, answer the call on the extension phone.**

2

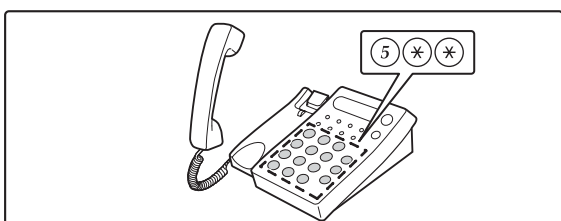

**Signal the machine to start fax reception.**

Press 5 \* \* on the keypad of the extension phone.

3

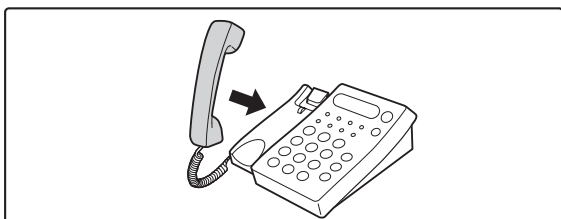

**Replace the extension phone.**

The machine sounds a beep when reception ends.

 If the extension phone is still lifted when fax transmission ends, an alarm signal will sound and a message will appear in the touch panel. The alarm and message will stop when the extension phone is replaced.

-  • **System Settings: Receive Setting** (page 7-109)  
To use remote fax reception, set this setting to "Manual Reception".
- **System Settings (Administrator): Remote Reception Number Setting**  
This is used to change the number used for remote fax reception. The factory default setting is "5".

## MAKING AND RECEIVING PHONE CALLS

You can make and receive calls like normal on your extension phone. A phone call can also be made by dialling on the machine.

# CHECKING THE STATUS OF FAX JOBS

This section explains how to check the status of reserved transmission jobs and received faxes.

## JOB STATUS SCREEN

The job status screen is displayed when the [JOB STATUS] key (Ⓜ) on the touch panel is touched. The job status screen shows the status of jobs by mode. When the [JOB STATUS] key (Ⓜ) is touched, the job status screen of the mode that was being used before the key was pressed appears.

Reserved transmissions and received faxes are referred to as jobs here.

### Example: Pressing the key in fax mode

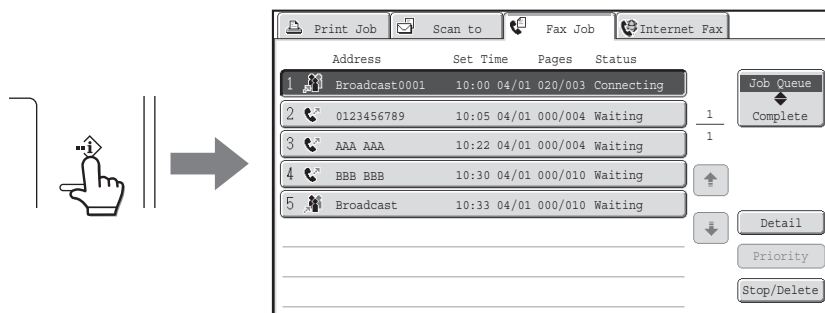

The job status display is in the lower left corner of the touch panel. The job status display can be touched to display the job status screen.

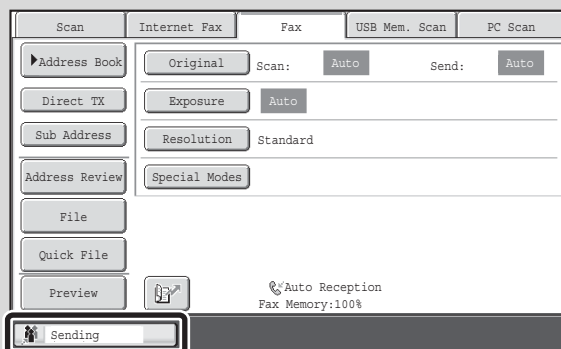



# JOB QUEUE SCREEN AND COMPLETED JOB SCREEN

The job status screen consists of two screens: the job queue screen, which shows reserved jobs and the job currently in progress, and the completed jobs screen. To switch between the two screens, touch the job status screen selector key ((2) below).

Job queue screen

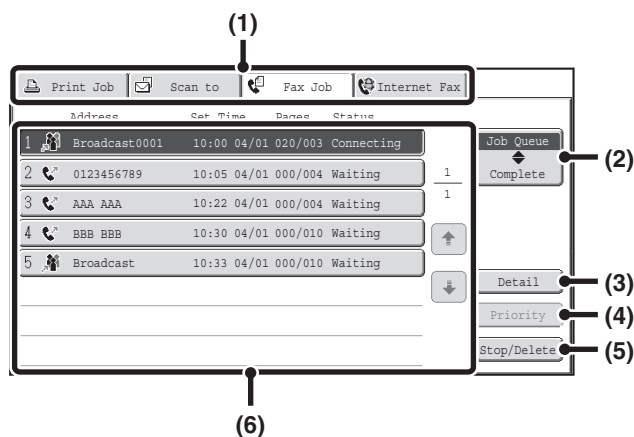

Completed job screen

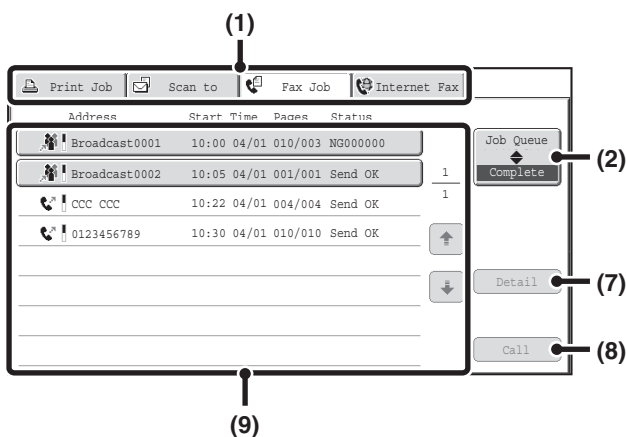

(1) **Mode select tabs**

Use these tabs to select the job status screen of each mode.

(2) **Job status screen selector key**

Touch this key to switch between the job queue screen and the completed jobs screen.

(3) **Job queue screen [Detail] key**

This shows detailed information on a broadcast transmission or serial polling job that is reserved or in progress. Select the key of the desired job in the job queue screen (6) and then touch the [Detail] key.

☞ [CHECKING A RESERVED JOB OR THE JOB IN PROGRESS](#) (page 4-133)

(4) **[Priority] key**

Touch this key to give priority to a selected job.

☞ [GIVING PRIORITY TO A RESERVED FAX JOB](#) (page 4-136)

(5) **[Stop/Delete] key**

Touch this key to stop or delete a selected job.

☞ [CANCELLING A FAX IN PROGRESS OR A RESERVED FAX](#) (page 4-135)

(6) **Job queue screen**

Jobs are shown as keys in the order they were reserved. Each key shows information on a job and its current status.

☞ [Job key display](#) (page 4-130)

(7) **Completed jobs screen [Detail] key\***

This shows detailed information on the results of completed broadcast transmission jobs, completed serial polling jobs, and completed jobs that used the document filing function. Select the key of the desired job in the completed jobs screen (9) and then touch the [Detail] key.

From the details screen, it is possible to resend the fax to destinations to which transmission was not successful.

☞ [CHECKING COMPLETED JOBS](#) (page 4-134)

\* On the MX-2314N, the productivity kit is required.

(8) **[Call] key**

Touch this key to retrieve and use a transmission or reception job that was stored using the document filing function.

(9) **Completed jobs screen**

This shows up to 99 completed transmission/reception jobs. A description of each job and the result (status) are shown.

Broadcast transmission jobs, serial polling jobs, received fax forwarding jobs, and transmission/reception jobs that used the document filing function are indicated as keys.

## Job key display

The following information is shown in the job queue keys and completed job keys that appear in the job status screen.

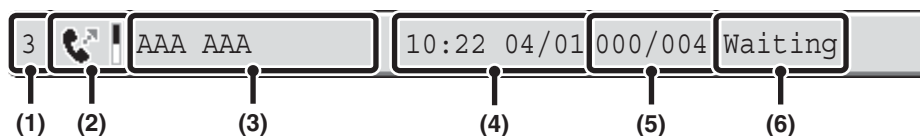

**(1) Indicates the number (position) of the job in the job queue.**

When the job currently being transmitted is finished, each job moves up one position in the job queue. This number does not appear in keys in the completed jobs screen.

**(2) Mode icon**

This indicates the type of job. In the completed jobs screen, a colour bar indicating black & white will appear next to the icon. (However, the colour bar icon does not appear in the key of a job that used document filing or in the key of a transmission/reception job that was cancelled.)

Icon	Job type
	Fax transmission
	Fax reception
	Broadcast transmission, Serial polling or Inbound routing
	PC-Fax transmission

**(3) Name of other party**

For a transmission, the name or fax number of the destination. For a reception, the fax number of the sending party. In the case of a broadcast transmission or serial polling operation, "Broadcast" or "Multi Polling" appears together with a broadcast control number (4-digits).

**(4) Time reserved / Time started**

In the job queue screen, the date and time the job was reserved. In the completed jobs screen, the date and time the job was started.

**(5) Number of pages**

Shows the number of pages transmitted / total number of original pages.

**(6) Status**

Shows the job status.

- Job in progress

Message	Status
"Connecting"	Connecting
"Sending"	Sending
"Receiving"	Receiving
"Tel"	Speaking with the other party using an extension phone
"Stopped"	The job has been stopped.
"Error"	An error occurred while the job was being executed.

- Job waiting to be executed

Message	Status
"Waiting"	The job is waiting to be executed.
"Retry Mode"	The job is being re-attempted due to a communication error or other problem.
The day and time are displayed.	Timer transmission job (the specified time is displayed)

- Completed job

Message	Status
"Send OK"	Transmission completed.
"In Memory"	Reception completed but the fax has not been printed.
"Received"	Printed received fax data.
"Forward OK"	The received fax has been forwarded.
"Stopped"	The job was stopped.
"Delete"	Deleted received data in the image check screen.
"Number of successful transmission destinations / Total destinations OK"	Completion of a broadcast transmission, serial polling or inbound routing operation. If transmission to 3 destinations was successful out of a total of 5, "003/005" will appear.
"No response"	An error occurred because there was no response from the destination.
"Busy"	An error occurred because the other party was busy.
"Reject Reception"	A fax was sent from a party that has been blocked by the anti junk fax function.
"NGxxxxxx"	Transmission/reception was not successful because a communication error occurred (a 6-digit error code appears in xxxxxx.)
"Error"	An error occurred while the job was being executed.

# OPERATION WHEN A JOB IN THE JOB QUEUE IS COMPLETED

When a normal transmission job is completed, it moves to the completed jobs screen and "Send OK" appears in the status column.

Received faxes, timer transmission jobs, retry jobs, and forwarding jobs are handled in the job status screen as explained below.

## Fax reception jobs

While a fax is being received, "Receiving" appears in the job queue screen.

When reception is completed, the job moves to the completed jobs screen and "In Memory" appears.

After the fax is printed, the status changes to "Printed".

## Timer transmission jobs

A timer transmission job appears at the bottom of the job queue screen until the specified time arrives.

When the specified time arrives, the job is executed. If another job is in progress, the timer job is started when the other job is completed.

## Retry jobs

A retry job appears at the bottom of the job queue screen. When the set retry interval elapses, the job is executed. If there are jobs reserved ahead of the retry job, the retry job is reserved at the bottom of the job queue and executed when its turn arrives.

## Fax reception jobs when Inbound Routing is enabled

When Inbound Routing is enabled in the Web pages, fax reception jobs are handled as follows depending on the print setting.

 [FORWARDING RECEIVED FAXES TO AN ADDRESS \(Inbound Routing Settings\)](#) (page 4-68)

- **Received fax is not printed**

"Receiving" appears in the job queue screen while the fax is being received. When reception is completed, the job moves to the job queue of the job status screen of scan mode.

- **Received fax is printed**

When reception is completed, the job moves to the completed jobs screen and "In Memory" appears. After the fax is printed, "Printed" appears. In addition, the job is added to the job queue of the job status screen of scan mode. When forwarding is finished, "Forward OK" appears.

# CHECKING A RESERVED JOB OR THE JOB IN PROGRESS

The detailed contents of a broadcast transmission or serial polling job can be displayed. Select (touch) the key of the job that you wish to check and touch the [Detail] key. The job details screen will appear (see below).

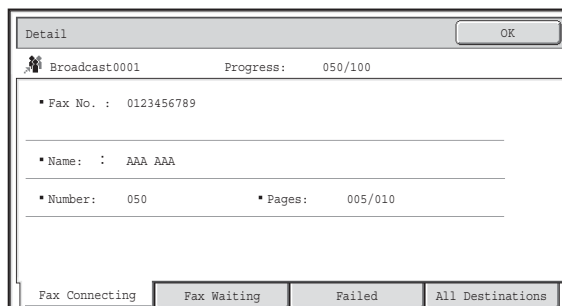

The job name and progress (number of completed destinations / total destinations) appear at the top of the screen. Touch a tab to display the information that appears on that tab. The following information appears on each tab.

Tab name	Information displayed
Fax Connecting	Information on the current destination appears. Fax No.: The fax number of the destination. Name: The name of the destination. Number: The broadcast control number (3-digits). Pages: Number of pages completed / total number of pages
Fax Waiting	This shows information on the destinations that are waiting. A broadcast control number (3-digits) appears in front of each destination. Address: The name of the other destination. Status: The status of communication.
Failed	This shows information on destinations for which communication failed. A broadcast control number (3-digits) appears in front of each destination. Address: The name or fax number of each destination. Start Time: The time when communication began. Status: The status of communication.
All Destinations	This shows all destinations specified in the job. A broadcast control number (3-digits) appears in front of each destination. Address: The name or fax number of the destination. Start time: The time at which communication began. Status: The status of communication.

## CHECKING COMPLETED JOBS

You can check a list of the destinations, the destinations for which transmission failed, and other detailed information on completed broadcast transmission jobs, received fax forwarding jobs, serial polling jobs, and jobs that used document filing. Touch the key of the desired job in the completed jobs screen and touch the [Detail] key. The job detail screen (see below) will appear.

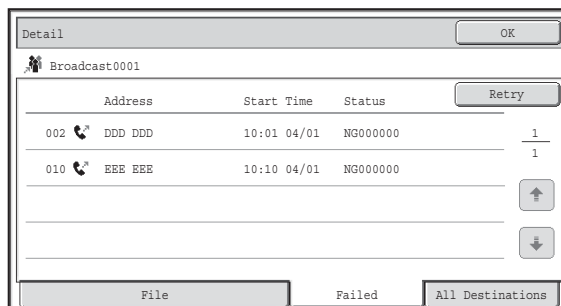

The job name appears at the top of the job detail screen.

To view details on the job, touch one of the tabs. The following information appears on each tab.

Tab name	Information displayed
File	Information on a transmission/reception that used document filing. To retrieve the file and use it, touch the [Call] key. (On the MX-2314N, the productivity kit is required.)
Failed	This shows information on destinations for which communication failed. A broadcast control number (3-digits) appears in front of each destination. Address: The name or fax number of each destination. Start time: Time at which communication began. Status: Description of failure (error) The [Retry] key can be touched to re-attempt transmission to that destination.*
All Destinations	Shows all addresses specified in the job. A broadcast control number (3-digits) appears in front of each destination. Address: The name or fax number of each destination. Start time: Time at which communication began. Status: Communication result The [Retry] key can be touched to transmit to all destinations again.*

\* Recalling is not possible for a broadcast transmission that includes a Scan to FTP address, Scan to Network Folder address, or Scan to Desktop address.

# CANCELLING A FAX IN PROGRESS OR A RESERVED FAX

Follow the steps below to cancel a fax transmission that is in progress or a reserved fax job.

1

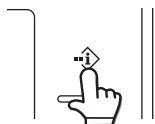

Touch the [JOB STATUS] key (ⓘ).

2

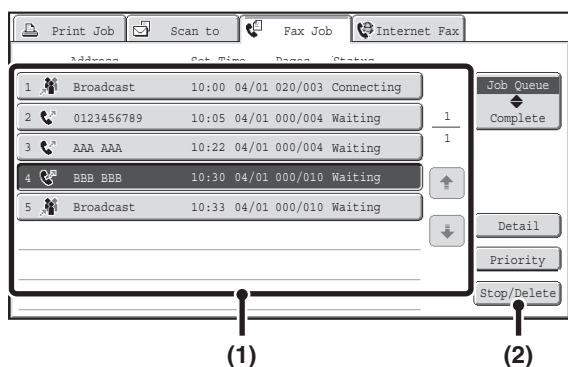

Select the fax job that you wish to cancel.

- (1) Touch the key of the fax job to be cancelled.
- (2) Touch the [Stop/Delete] key.

3

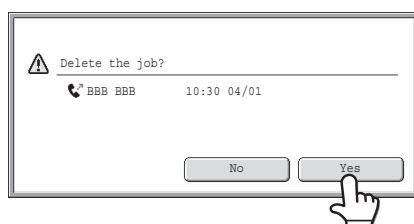

Touch the [Yes] key.



**If you do not wish to cancel the selected fax job...**  
Touch the [NO] key.



Printing of received faxes and forwarding jobs set using "Inbound Routing Settings" cannot be cancelled.

[FORWARDING RECEIVED FAXES TO AN ADDRESS \(Inbound Routing Settings\)](#) (page 4-68)

# GIVING PRIORITY TO A RESERVED FAX JOB

When multiple jobs are waiting to be transmitted, the jobs are normally transmitted in the order they were reserved. If you need to give priority to a job and send it ahead of the other jobs, follow the steps below.

1

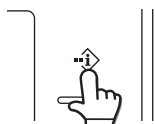

Touch the [JOB STATUS] key (⌂).

2

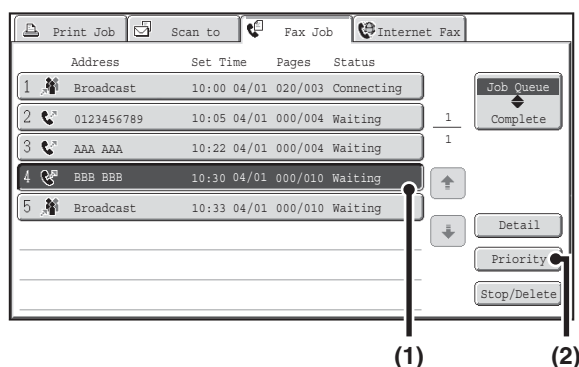

Select the fax job to which you wish to give priority.

- (1) Touch the key of the desired job.
- (2) Touch the [Priority] key.

The selected job moves up to the position immediately following the job in progress. The job will be executed when the job in progress is completed.

 If the job in progress is a broadcast transmission job or a serial polling job, the priority job will be transmitted between destinations of the broadcast transmission or serial polling job. However, if the priority job is a broadcast transmission job or a serial polling job, it will be executed after the current job is completed.



---

---

# CHECKING THE ACTIVITY LOG (Image Sending Activity Report)

## IMAGE SENDING ACTIVITY REPORT

You can have the machine print a log of recent image sending activity (date, name of other party, time required, result, etc.). The Image Sending Activity Report contains useful information such as the types of errors that occurred.

The most recent 200 transactions are included in the report.

You can have the machine print the Image Sending Activity Report each time the number of transactions reaches 201, or at a specified time (once a day only).

 The contents of the Image Sending Activity Report are erased when the report is printed, and thus it cannot be reprinted.

 **System Settings (Administrator): Activity Report Print Select Setting**  
This is used to set the conditions for printing activity reports. The factory default setting is not to print.  
The Image Sending Activity Report can be set to print each time the number of transactions reaches 201, or at a specified time (once a day only).

## INFORMATION APPEARING IN THE RESULT COLUMN

Error types and other information are printed in the result column of transaction and activity reports. When a transaction report or activity report is printed, check the result of the transaction in the result column and take action as needed.

### Examples of messages that are printed in the result column

Message	Explanation
OK	The transaction was completed normally.
G3	Communication took place in G3 mode.
ECM	Communication took place in G3 ECM mode.
SG3	Communication took place in Super G3 mode.
Forwarding	The received data was forwarded.
NO RESPONSE	No response from the receiving party.
BUSY	Transmission was not possible because the other party was already using the line.
CANCEL	The transmission was cancelled while in progress.
MEMORY OVER	The memory became full during quick on-line transmission.
MEM.FULL	The memory became full during reception.
LENGTH OVER	The transmitted fax was over 1.5 m (59") long and therefore could not be received.
ORIGINAL ERROR	Direct transmission or manual transmission was not successful because a misfeed occurred.
PASS# NG	The connection was broken because the polling passcode was not correct.
NO RX POLL	The machine that was polled does not have a polling function.
RX POLL FAIL	The other machine refused the polling operation, or your machine broke the connection when polled because no data was in memory.
NO F-CODE POLL	The other machine refused an F-code polling operation, or your machine broke the connection when polled because no data was in its F-code memory polling box.
RX POLL# NG	The connection was broken because the sub-address for F-code polling memory was not valid.
F POLL PASS# NG	The connection was broken because the passcode for F-code polling memory was not valid.
BOX NO. NG	Your machine broke the connection because the specified sub-address for an F-code memory box does not exist.
F PASS# NG	Your machine broke the connection because the other machine sent an incorrect passcode for F-code communication.
RX NO F-CODE POLL	F-code polling was attempted, however, the other machine did not have an F-code polling memory box.
NO F FUNC	F-code communication was attempted, however, the other machine does not support F-code communication.
NO F-CODE	F-code communication was refused by the other machine because of an incorrect sub-address or other reason.
M. BOX: [xxxxxx] *****	Data was received to a confidential or relay broadcast memory box, or data was sent from a memory polling box. The name of the memory box appears in [xxxxxx], and the type of F-code operation (relay request reception, polling memory transmission, or confidential reception) appears in *****.
FAIL xx (xxxx)	The transaction failed due to a communication error. First 2 digits of communication error number: Error code from 00 to 99. Last 4 digits of communication error number: Code for use by service technicians.
REJECTED	A fax was sent from a party from which reception is blocked.

# FACSIMILE SPECIFICATIONS

<b>Model</b>	MX-FX11	
<b>Applicable telephone line</b>	Public switched telephone network, PBX	
<b>Scanning resolution (supports ITU-T standards)</b>	8 x 3.85 lines/mm (Standard), 8 x 7.7 lines/mm (Fine, Fine-Halftone), 8 x 15.4 lines/mm (Super Fine, Super Fine - Halftone), 16 x 15.4 lines/mm (Ultra Fine, Ultra Fine - Halftone)	
<b>Transmission speed</b>	33.6 kbps down to 2.4 kbps Automatic fallback	
<b>Compression method</b>	MH / MR / MMR / JBIG	
<b>Transmission modes</b>	Super G3, G3 (the machine can only send faxes to and receive faxes from machines that support G3 or Super G3)	
<b>Input document size</b>	AB sizes: A3, B4, A4, A4R, B5, B5R, A5, 216 mm x 340 mm, 216 mm x 343 mm Inch sizes: 11" x 17", 8-1/2" x 14", 8-1/2" x 13-2/5", 8-1/2" x 13", 8-1/2" x 11", 8-1/2" x 11"R, 5-1/2" x 8-1/2" Long originals (max. width 297 mm (11-45/64") x max. length 1000 mm (39-23/64") can be transmitted using the automatic document feeder. Scanning one side is possible.)	
<b>Paper sizes</b>	A3, B4, A4, A4R, B5, B5R, A5R (11" x 17", 8-1/2" x 14", 8-1/2" x 13-2/5", 8-1/2" x 13", 8-1/2" x 11", 8-1/2" x 11"R, 5-1/2" x 8-1/2"R)	
<b>Transmission time *1</b>	Approx. 2 seconds (Super G3 mode/33.6 kbps, JBIG) Approx. 6 seconds (G3 ECM mode/14.4 kbps)	
<b>Power supply</b>	Supplied from the machine	
<b>Dimensions</b>	192 mm (W) x 52 mm (D) x 215 mm (H) (7-9/16" (W) x 2-3/64" (D) x 8-15/32" (H))	
<b>Weight</b>	Approx. 1.0 kg (2.2 lbs.)	
<b>Remarks</b>	Extension telephone connection	Possible (1 telephone)
	Number of one-touch keys for storing destinations*2	Maximum number of keys: 1000
	Number of destinations that can be stored in a group (1 key)*2	Maximum number of destinations in one group (1 key): 500
	Timer transmission	Yes
	Program function	Yes (48 programs)
	F-code transmission	Supported (SUB/SEP (sub-address) and SID/PWD (passcode) signals can be transmitted / received)
	Image memory	1 GB*3

\*1 Transmission speed is for an A4 or 8-1/2" x 11" document with approximately 700 characters at standard resolution (8 x 3.85 lines/mm) sent in high speed mode (33.6 kbps (JBIG) or 14.4 kbps). This is only the time required to transmit the image information; the time required to send protocol signals is not included. Actual transmission times will vary depending on the contents of the document, the receiving machine type, and telephone line conditions.

\*2 Total number of all destinations (Scan to E-mail, Scan to FTP, Scan to Desktop, Scan to Network folder, Internet Fax, Fax and Group)

\*3 For the MX-2314N: 512 MB standard, 1GB when the productivity kit is installed.

# CHAPTER 5

# SCANNER/INTERNET FAX

This chapter provides detailed explanations of the procedures for using the scanner function and the Internet fax function. USB memory mode can be used without installing a peripheral device. To use the Internet fax function, the Internet fax expansion kit is needed. (On the MX-2314N, the productivity kit is required.)

## BEFORE USING THE MACHINE AS A NETWORK SCANNER

<b>NETWORK SCANNER FUNCTION</b> .....	5-3
<b>PREPARATIONS FOR USE AS A NETWORK SCANNER</b> .....	5-5
• MAKE SURE THE MAIN POWER SWITCH IS IN THE "ON" POSITION .....	5-5
• CHECKING THE DATE AND TIME .....	5-5
• STORING SENDER INFORMATION .....	5-5
• SETTINGS REQUIRED IN THE WEB PAGES .....	5-6
• STORING DESTINATION ADDRESSES FOR EACH SCAN MODE IN THE ADDRESS BOOK .....	5-6
• STORING A DESTINATION FOR SCAN TO DESKTOP .....	5-7
• BEFORE SENDING TO A DIRECT SMTP ADDRESS .....	5-8
<b>BASE SCREEN</b> .....	5-9
• ADDRESS BOOK SCREEN .....	5-12
• CHANGING THE DISPLAY OF ONE-TOUCH KEYS IN THE ADDRESS BOOK SCREEN .....	5-13
<b>SCAN SEND SEQUENCE</b> .....	5-15
<b>ORIGINAL SIZES</b> .....	5-17
• TRANSMITTABLE ORIGINAL SIZES .....	5-17
• THE SIZE OF THE PLACED ORIGINAL .....	5-17

## ENTERING DESTINATIONS

<b>RETRIEVING A DESTINATION FROM THE ADDRESS BOOK</b> .....	5-18
• RETRIEVING A DESTINATION .....	5-19
• CHECKING AND DELETING THE SELECTED DESTINATIONS .....	5-20
<b>USING A SEARCH NUMBER TO RETRIEVE A DESTINATION</b> .....	5-21
<b>ENTERING AN ADDRESS MANUALLY</b> .....	5-22
• SPECIFYING A NETWORK FOLDER .....	5-23
<b>RETRIEVING A DESTINATION FROM A GLOBAL ADDRESS BOOK</b> .....	5-25
<b>USING THE RESEND FUNCTION</b> .....	5-27

## TRANSMITTING AN IMAGE

<b>SENDING AN IMAGE IN SCAN MODE</b> .....	5-28
• CHANGING THE SUBJECT, FILE NAME, REPLY-TO, AND BODY TEXT* .....	5-32
<b>SENDING AN IMAGE IN USB MEMORY MODE</b> .....	5-35
• SPECIFY THE FOLDER IN WHICH THE FILE WILL BE STORED .....	5-39
• ENTERING A FILE NAME .....	5-40
<b>SENDING A FAX IN INTERNET FAX MODE</b> .....	5-41
• CHANGING THE SUBJECT, FILE NAME, AND BODY TEXT .....	5-44
<b>SENDING THE SAME IMAGE TO MULTIPLE DESTINATIONS (Broadcast Transmission)</b> .....	5-47
• BROADCAST TRANSMISSIONS THAT INCLUDE INTERNET FAX DESTINATIONS .....	5-50
<b>SENDING AN INTERNET FAX FROM A COMPUTER (PC-I-Fax)</b> .....	5-52
<b>IMAGE SETTINGS</b> .....	5-53
• AUTOMATICALLY SCANNING BOTH SIDES OF AN ORIGINAL (2-Sided Original) .....	5-54
• SPECIFYING THE ORIGINAL SCAN SIZE AND SEND SIZE (Enlarge/Reduce) .....	5-55
• CHANGING THE EXPOSURE AND ORIGINAL IMAGE TYPE .....	5-61
• CHANGING THE RESOLUTION .....	5-63
• CHANGING THE FILE FORMAT .....	5-64
• CHANGING THE COLOUR MODE .....	5-68
<b>CHECKING THE IMAGE TO BE TRANSMITTED (Preview)</b> .....	5-69
• PREVIEW CHECK SCREEN .....	5-70

**SPECIAL MODES**

**SPECIAL MODES** ..... 5-71

**STORING SCAN OPERATIONS (Programs)** .... 5-73

**ERASING PERIPHERAL SHADOWS ON THE IMAGE (Erase)** ..... 5-75

**SCANNING AN ORIGINAL AS TWO SEPARATE PAGES (Dual Page Scan)**..... 5-77

**SENDING AN IMAGE AT A SPECIFIED TIME (Timer Transmission)** ..... 5-79

**WHITENING FAINT COLOURS IN THE IMAGE (Suppress Background)**..... 5-81

**SCANNING BOTH SIDES OF A CARD ONTO A SINGLE PAGE (Card Shot)** ..... 5-83

**SCANNING MANY ORIGINALS AT ONCE (Job Build)**... 5-86

**SCANNING ORIGINALS OF DIFFERENT SIZES (Mixed Size Original)** ..... 5-88

**SCANNING THIN ORIGINALS (Slow Scan Mode)** .... 5-90

**CHECKING THE NUMBER OF SCANNED ORIGINAL SHEETS BEFORE TRANSMISSION (Original Count)** ..... 5-92

**STAMPING SCANNED ORIGINALS (Verif. Stamp)** ... 5-94

**ELIMINATING BLANK PAGES FROM A TRANSMISSION (Blank Page Skip)** ..... 5-96

**SENDING TWO PAGES AS A SINGLE PAGE (2in1)**..... 5-98

**CHANGING THE PRINT SETTINGS FOR THE TRANSACTION REPORT (Transaction Report)**.. 5-101

**CHECKING THE STATUS OF TRANSMISSION/RECEPTION JOBS**

**JOB STATUS SCREEN** ..... 5-103

- **JOB QUEUE SCREEN AND COMPLETED JOB SCREEN**..... 5-104
- **OPERATION WHEN A JOB IN THE JOB QUEUE IS COMPLETED**..... 5-107
- **CHECKING COMPLETED JOBS**..... 5-108

**STOPPING A SCAN JOB BEING TRANSMITTED OR WAITING TO BE TRANSMITTED** ..... 5-109

**GIVING PRIORITY TO A SCAN TRANSMISSION JOB** ..... 5-110

**CHECKING THE INTERNET FAX ACTIVITY LOG (Image Sending Activity Report)**..... 5-111

- **IMAGE SENDING ACTIVITY REPORT** .... 5-111
- **INFORMATION APPEARING IN THE RESULT COLUMN**..... 5-111

**INTERNET FAX RECEPTION FUNCTIONS**

**RECEIVING AN INTERNET FAX**..... 5-112

- **MANUALLY RECEIVING INTERNET FAXES** ..... 5-113

**PRINTING A PASSWORD-PROTECTED FAX (Hold Setting For Received Data Print)**..... 5-114

**CHECKING THE IMAGE BEFORE PRINTING** .. 5-115

**CHECKING THE IMAGE BEFORE FORWARDING**..... 5-116

- **IMAGE CHECK SCREEN** ..... 5-118

**FORWARDING RECEIVED INTERNET FAXES TO AN ADDRESS (Inbound Routing Settings)**..... 5-119

- **CONFIGURING INBOUND ROUTING SETTINGS** ..... 5-119

**SCANNING FROM A COMPUTER (PC Scan Mode)**

**BASIC SCANNING PROCEDURE**..... 5-123

**METADATA DELIVERY**

**METADATA DELIVERY (Data Entry)** ..... 5-128

**PREPARATIONS FOR METADATA TRANSMISSION**..... 5-129

- **SETTINGS REQUIRED IN THE WEB PAGES** ..... 5-129
- **METADATA TRANSMISSION FOR SCAN TO DESKTOP** ..... 5-129

**TRANSMITTING METADATA** ..... 5-130

- **METADATA FIELDS** ..... 5-132

**NETWORK SCANNER / INTERNET FAX SPECIFICATIONS** ..... 5-133

**PULL SCAN FUNCTION (TWAIN) SPECIFICATIONS** ..... 5-133

# BEFORE USING THE MACHINE AS A NETWORK SCANNER

This section provides information that you should know before using the machine as a network scanner.

## NETWORK SCANNER FUNCTION

The network scanner function of the machine can be used to scan an original, create an image file, and send the file over a network to a computer, FTP server, or other destination. Scanning is also possible from your computer using a TWAIN-compliant application.

The network scanner function provides the following scanning modes.

### Scan modes

 [SENDING AN IMAGE IN SCAN MODE](#) (page 5-28)

#### Scan to E-mail

The scanned file is sent to an e-mail address.



#### Scan to FTP

The scanned file is sent to a specified directory of an FTP server. When the file is sent, it is also possible to send an e-mail to a previously stored e-mail address to inform the recipient of the location of the file. (This is called "Scan to FTP (Hyperlink)".)



#### Scan to Desktop

The scanned file is sent to a specified folder on your computer. To use Scan to Desktop, software must be installed from the "Sharpdesk/Network Scanner Utilities" CD-ROM that accompanies the machine. For the system requirements of the software, see the manual (PDF format) or the Readme file on the CD-ROM. For the procedures for installing the software, see the "Sharpdesk Installation Guide".



#### Scan to Network Folder

The scanned file is sent to a network folder on a Windows computer on the same network as the machine.



## USB memory mode

 [SENDING AN IMAGE IN USB MEMORY MODE](#) (page 5-35)

### USB Memory Scan

The scanned file is sent to and stored in a USB memory device connected to the machine.



## Internet fax mode

To use the Internet fax function, Internet fax expansion kit must be installed. (On the MX-2314N, the productivity kit is required.)

 [SENDING A FAX IN INTERNET FAX MODE](#) (page 5-41)

### Internet fax transmission

The scanned file is sent as an Internet fax. Reception of Internet faxes is also possible. The machine supports Direct SMTP, which lets you directly send Internet faxes within your company without using a mail server.

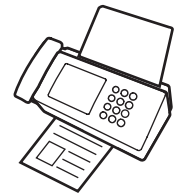

## PC scan mode

(On the MX-2314N, the productivity kit is required.)

 [SCANNING FROM A COMPUTER \(PC Scan Mode\)](#) (page 5-123)

### PC Scan

A TWAIN-compliant application on a computer connected to the same network as the machine is used to scan a document or image.

To use PC Scan, the scanner driver must be installed from the "Software CD-ROM" that accompanies the machine.

Operating systems that can be used are Windows XP/Server 2003/Vista/Server 2008/7/Server 2012/8.



## Data entry mode

The application integration module is required to use the metadata transmission function. (On the MX-2314N, the productivity kit is required.)

 [METADATA DELIVERY](#) (page 5-128)

### Metadata delivery

The application integration module can be combined with the network scanner function to append a metadata\* file to a scanned image file. (This is called metadata delivery.)

Information entered using the touch panel or automatically generated by the machine can be sent to a directory on an FTP server or an application on a computer as a metadata file in XML format.

\* Metadata is information about a file, how it is to be processed, and its relation to other objects.

# PREPARATIONS FOR USE AS A NETWORK SCANNER

## MAKE SURE THE MAIN POWER SWITCH IS IN THE "ON" POSITION

The main power is "on" when the main power indicator on the right side of the operation panel is lit.

If the main power indicator is not lit, the main power is "off". Switch the main power switch to the "on" position and press the [POWER] key (⏻) on the operation panel.

If the Internet fax function will be used, and in particular if reception or timer transmission will take place at night, always keep the main power switch in the "on" position.

 When the [POWER SAVE] key (⏻) indicator light is blinking, the machine is in auto power shut-off mode. If the [POWER SAVE] key (⏻) is pressed when the indicator is blinking, the indicator will turn off and the machine will return to the ready state after a brief interval.

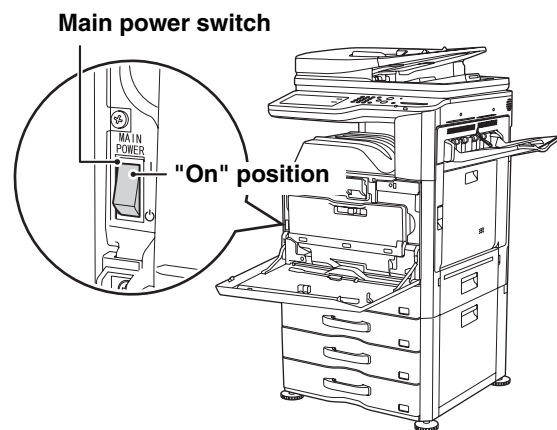
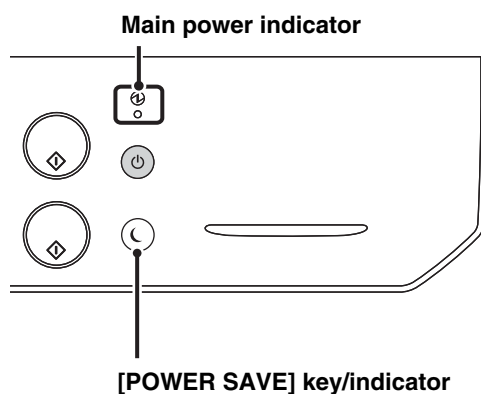

## CHECKING THE DATE AND TIME

Verify that the correct date and time are set in the machine.

The date and time are set in the system settings of the machine. When the [SYSTEM SETTINGS] key (⬢) is touched, the system settings menu screen appears on the touch panel. Select [Default Settings], [Clock], and [Clock Adjust], and set the year, month, day, hour, and minute.

 If "Disabling of Clock Adjustment" has been enabled in the system settings (administrator), the date and time cannot be set.

## STORING SENDER INFORMATION

Be sure to configure this information, as it is required for communication.

### Before using Scan to E-mail

Store a default sender name in "Sender Name" and a reply e-mail address in "Reply E-mail Address". These will be used when a sender is not selected.

 **System Settings (Administrator): Default Sender Set**  
This is used to store the sender name and e-mail address that is used when a sender is not selected.

### Before using Internet fax

Store a sender name in "Sender Name" and a sender Internet fax address in "Own Address".

 **System Settings (Administrator): Sender Data Registration**  
Use this setting to program the sender name and sender address.



## SETTINGS REQUIRED IN THE WEB PAGES

To use scan mode and Internet fax mode, the basic network scanner settings, server settings such SMTP and DNS server settings, and sender addresses must be configured in the Web pages.

- **Server settings**

To configure server settings, click [Network Settings] and then [Services Settings] in the Web page menu. (Administrator rights are required.)

- **Basic network scanner settings**

To configure network scanner settings, click [Application Settings] and then [Network Scanner Settings] in the Web page menu. (Administrator rights are required.)

- **Internet fax settings**

To configure the network scanner settings, click [Application Settings] and then [Internet Fax Settings] in the Web page menu. (Administrator rights are required.)

## STORING DESTINATION ADDRESSES FOR EACH SCAN MODE IN THE ADDRESS BOOK

To use Scan to FTP or Scan to Desktop, the destination must be stored in the address book. For Scan to E-mail, Internet Fax, and Scan to Network Folder, the destination can be directly entered or looked up in a global address book at the time of transmission, however, the procedure is simpler when the destination is stored in the address book. Store each type of destination as explained below.

### Types of transmission in scanner mode

- Scan to FTP: Click [Address Book] in the Web page menu and then click the [Add] button. Select [FTP] in [Address Type] and store an address.
- Scan to Network Folder: Click [Address Book] in the Web page menu and then click the [Add] button. Select [Network Folder] in [Address Type] and store an address.
- Scan to E-mail: Click [Address Book] in the Web page menu and then click the [Add] button. Select [E-mail] in [Address Type] and store an address. Addresses can also be stored in the system settings.
- Scan to Desktop: See "[STORING A DESTINATION FOR SCAN TO DESKTOP](#)" (page 5-7). Scan to Desktop destinations can also be stored in the Web pages. Click [Address Book] in the Web page menu and then click the [Add] button. Select [Desktop] in [Address Type] and store an address.



A total of 1000 addresses can be stored.

### Transmission in Internet fax mode:

Click [Address Book] in the Web page menu and then click the [Add] button. Select [Internet Fax] or [Direct SMTP] for the [Address Type], and store the address. Addresses can also be stored in the system settings.



**System Settings:** [Address Book \(page 7-16\)](#)

This is used to store destination addresses for Scan to E-mail and Internet fax.

# STORING A DESTINATION FOR SCAN TO DESKTOP

To store your computer in the machine as a destination for Scan to Desktop, Network Scanner Tool must be installed from the "Sharpdesk/Network Scanner Utilities" CD-ROM that accompanies the machine. To scan an image to your computer, Network Scanner Tool must be running on your computer.

## INSTALLING NETWORK SCANNER TOOL

To install Network Scanner Tool, see the "Sharpdesk Installation Guide" that accompanies the machine. When a standard installation is performed, Network Scanner Tool is installed with Sharpdesk.

When you restart your computer after installing Network Scanner Tool, the Setup Wizard will start automatically. Follow this wizard to set up Network Scanner Tool. This will store your computer in the machine as a destination for Scan to Desktop. The stored destination will be displayed as a one-touch key in the address book screen.

The following window appears while Network Scanner Tool is being set up. The item selected in "My Profiles" (C) will be the name of the one-touch key.

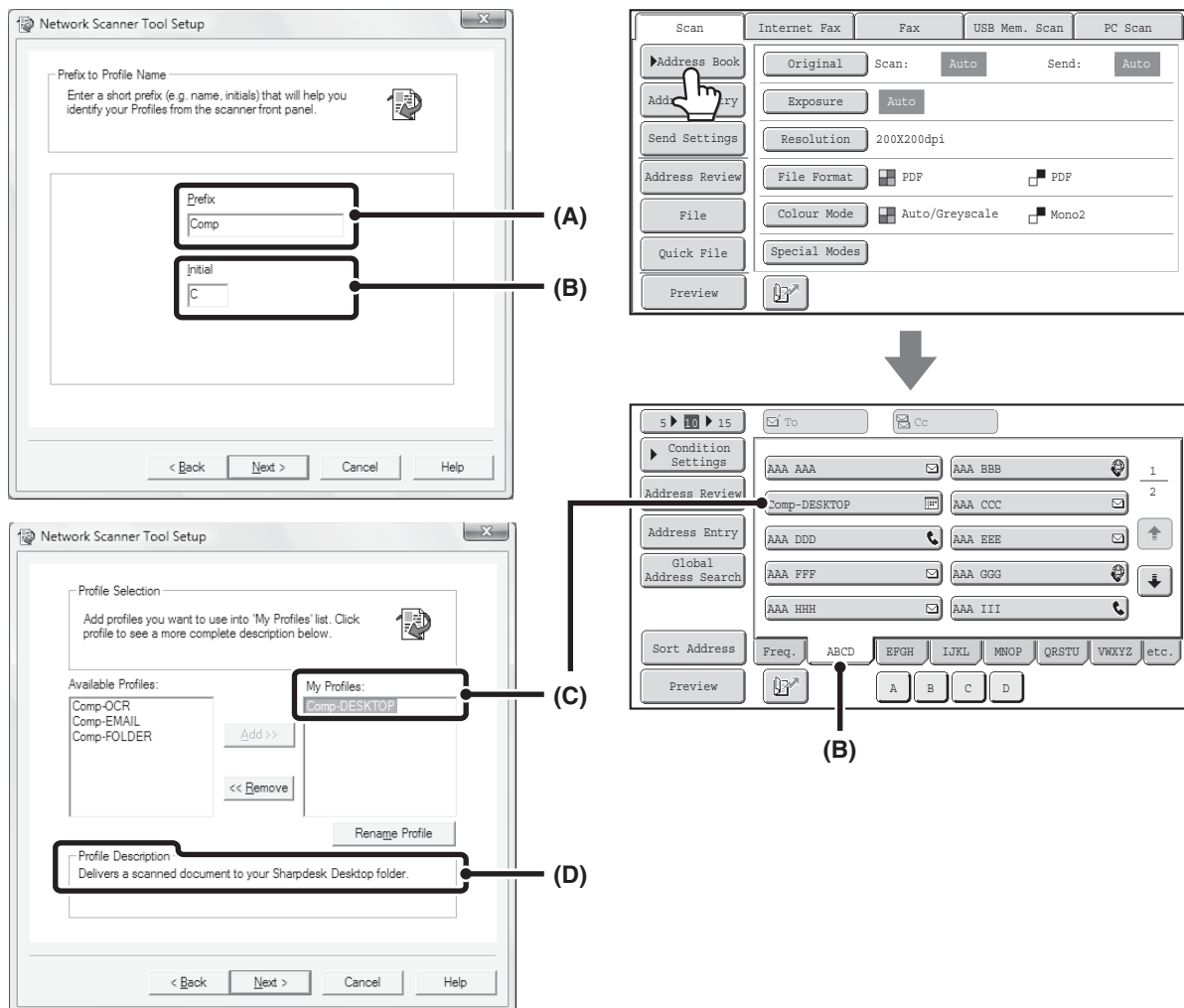

The profile name is determined by the combination of the text entered in "Prefix" (A) and the profile\*.

The one-touch key is assigned to an index tab in the address book screen based on the text entered in "Initial" (B).

\* This defines how an image sent to your computer is processed. For more information, see profile explanation (D).

## ADDING DESTINATIONS

For the number of computers that can be stored in the machine as destinations of Scan to Desktop, see the number of licences indicated in the "Sharpdesk Installation Guide". To store more destinations, a licence kit is required. Store Scan to Desktop destinations by installing Network Scanner Tool on each computer.

## BEFORE SENDING TO A DIRECT SMTP ADDRESS

The machine supports Direct SMTP, which lets you directly send Internet faxes within your company without using a mail server. For the procedure for storing a Direct SMTP address in the address book, see "[STORING DESTINATION ADDRESSES FOR EACH SCAN MODE IN THE ADDRESS BOOK](#)" (page 5-6). Stored Direct SMTP addresses are included in the address book for Internet fax mode.

### If the destination is busy

If the destination is busy, the machine will wait briefly and then automatically resend.



#### To cancel transmission...

Cancel the transmission from the job status screen.

[STOPPING A SCAN JOB BEING TRANSMITTED OR WAITING TO BE TRANSMITTED](#) (page 5-109)



#### System Settings (Administrator): Recall in Case of Line Busy

This is used to set the number of recall attempts and the interval between attempts when the connection cannot be established because the line is busy.

### When a communication error occurs

If a communication error occurs or the other fax machine does not answer the call within a preset period of time, transmission will be re-attempted automatically after a preset interval.



#### To cancel transmission...

Cancel the transmission from the job status screen.

[STOPPING A SCAN JOB BEING TRANSMITTED OR WAITING TO BE TRANSMITTED](#) (page 5-109)



#### System Settings (Administrator): Recall in Case of Communication Error

This is used to set the number of recall attempts and the interval between attempts when a transmission fails due to an error.

# BASE SCREEN

Scan mode, USB memory mode, Internet fax mode, and PC scan mode are used by selecting operations and settings in the base screens of those modes. To display the base screen of a mode, touch the [IMAGE SEND] key in the touch panel and then touch the tab of the mode that you wish to use.

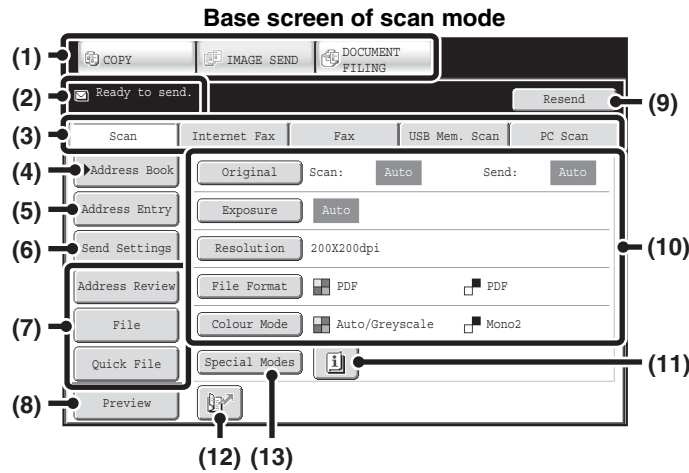

Base screen of USB memory mode

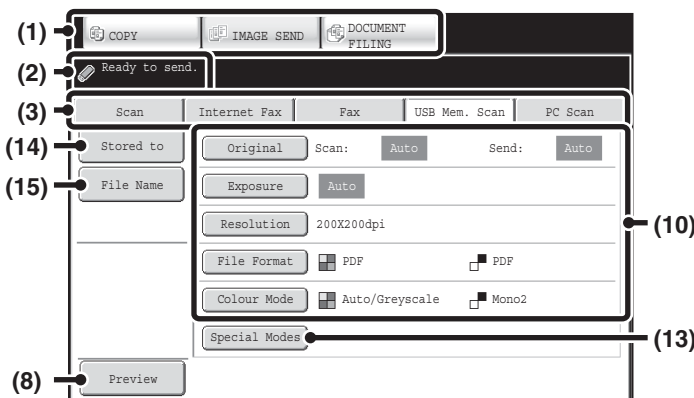

Base screen of Internet fax mode

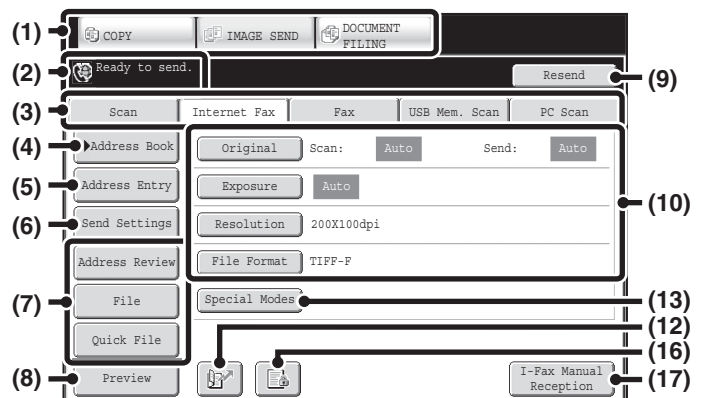

**(1) Mode select keys**

Use these keys to switch between copy, image send, and document filing modes.

To use scan mode, USB memory mode, Internet fax mode, PC scan mode, or data entry mode, touch the [IMAGE SEND] key.

**(2) Various messages are displayed here.**

The icon of the selected mode appears on the left.

**(3) Send mode tabs**

Touch one of these tabs to change the image send mode. Tabs of modes that cannot be used because the corresponding options are not installed do not appear. If the [USB Mem. Scan] and [PC Scan] tabs do not appear, touch the [Right Arrow] tab to move the screen. If the [Scan], [Internet Fax], [Fax], and [Data Entry] tabs do not appear, touch the [Left Arrow] tab move the screen.

The [Data Entry] tab appears when the application integration module is installed. For information on metadata delivery using the [Data Entry] tab, see "METADATA DELIVERY" (page 5-128).

**(4) [Address Book] key**

Touch this key to use a one-touch key or a group key. When the key is touched, the address book screen appears.

➤ [RETRIEVING A DESTINATION FROM THE ADDRESS BOOK](#) (page 5-18)

**(5) [Address Entry] key**

Touch this key to manually enter an destination address instead of using a one-touch key.

➤ [ENTERING AN ADDRESS MANUALLY](#) (page 5-22)

**(6) [Send Settings] key**

Touch this key to select or enter the subject, file name, sender name, or body text, which has been previously stored in the Web page.

Scan modes:

➤ [CHANGING THE SUBJECT, FILE NAME, REPLY-TO, AND BODY TEXT\\*](#) (page 5-32)

Internet fax mode:

➤ [CHANGING THE SUBJECT, FILE NAME, AND BODY TEXT](#) (page 5-44)

**(7) Customized keys**

The keys that appear here can be changed to show settings or functions that you prefer.

➤ [Customizing displayed keys](#) (page 5-11)

**(8) [Preview] key\***

Touch to check the image that will be sent in the touch panel before transmission.

➤ [CHECKING THE IMAGE TO BE TRANSMITTED \(Preview\)](#) (page 5-69)

\* On the MX-2314N, the productivity kit is required.

**(9) [Resend] key/[Next Address] key**

The destinations of the most recent 8 transmissions by Scan to E-mail, fax and/or Internet fax are stored. Touch this key to select one of these destinations. After a destination is selected, this key changes to the [Next Address] key.

➤ [USING THE RESEND FUNCTION](#) (page 5-27)

➤ [RETRIEVING A DESTINATION](#) (page 5-19)

**(10) Image settings**

Image settings (original size, exposure, resolution, file format, and colour mode) can be selected.

➤ [IMAGE SETTINGS](#) (page 5-53)

**(11) [Key] key**

This key appears when a special mode or 2-sided scanning is selected. Touch the key to display the selected special modes.

➤ [Checking what special modes are selected](#) (page 5-11)

**(12) [Key] key**

Touch this key to specify a destination using a search number\*.

\* 4-digit number assigned to a destination when it is stored.

➤ [USING A SEARCH NUMBER TO RETRIEVE A DESTINATION](#) (page 5-21)

**(13) [Special Modes] key**

Touch this key to use a special mode.

➤ [SPECIAL MODES](#) (page 5-71)

**(14) [Stored to] key**

Touch to select the folder in USB memory where a file will be stored.

➤ [SPECIFY THE FOLDER IN WHICH THE FILE WILL BE STORED](#) (page 5-39)

**(15) [File Name] key**

Touch this key to enter a file name when storing a file to USB memory.

➤ [ENTERING A FILE NAME](#) (page 5-40)

**(16) [Key] / [Key] / [Key] key**

When "Hold Setting for Received Data Print" or "Received Data Image Check Setting" is enabled in the system settings (administrator), this will appear when an Internet fax is received.

[Key] : Only "Hold Setting for Received Data Print" is enabled

[Key] : Only "Received Data Image Check Setting" is enabled

[Key] : Both settings are enabled

➤ [PRINTING A PASSWORD-PROTECTED FAX \(Hold Setting For Received Data Print\)](#) (page 5-114)

➤ [CHECKING THE IMAGE BEFORE PRINTING](#) (page 5-115)

**(17) [I-Fax Manual Reception] key**

Touch this key to receive an Internet fax manually.

➤ [MANUALLY RECEIVING INTERNET FAXES](#) (page 5-113)

When sending an image, you can retrieve and use a stored transmission destination from the address book screen. The address book screen is shared by scan mode, Internet fax mode, fax mode and data entry mode.

Touch the [Address Book] key in the base screen to switch to the address book screen. Touch the [Condition Settings] key in the address book screen to switch to the base screen.

**Base screen of scan mode**

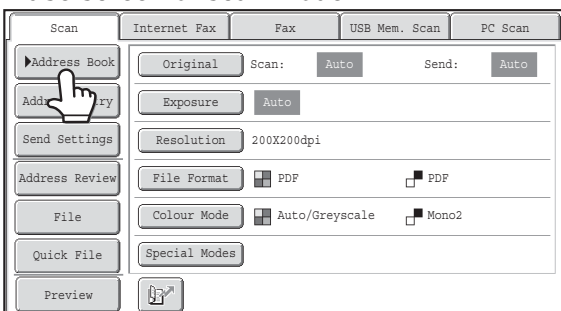

**Address book screen**

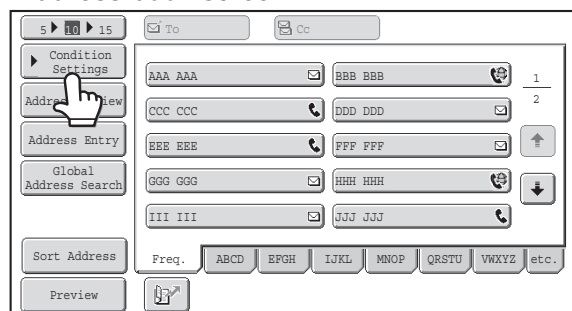

- This chapter uses the base screen of scan mode as an example when operations common to all modes are explained.
- The procedures in this chapter assume that the base screen of scan mode appears when the [IMAGE SEND] key is touched.

**System Settings (Administrator): Default Display Settings**

One of the following screens can be selected for the initial screen that appears when the [IMAGE SEND] key is touched.

- Base screen of each mode (scan, Internet fax, fax, or data entry mode)
- Address book screen

## Customizing displayed keys

Special mode keys and other keys can be displayed in the base screen. Set these keys to functions that you frequently use to access the functions with a single touch. The customized keys are configured using "Customize Key Setting" in the Web pages. The following keys appear by factory default:

- **[Address Review] key**

Touch this key to display a list of the destinations that have been selected in the address book. This is the same key as the [Address Review] key in the address book screen.

- **[File] key, [Quick File] key**

Touch either of these keys to use the File function or Quick File function of document filing mode.  
(On the MX-2314N, the productivity kit is required.)

### In USB memory mode...

Customized keys do not initially appear, however, up to three keys can be added.

**Example: When "Dual Page Scan", "Job Build", and "Mixed Size Original" are assigned to the customized keys**

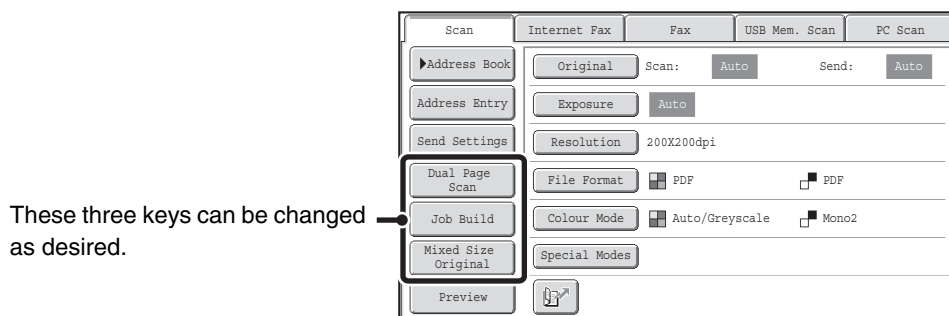

- Displaying a program key in the base screen will enable you to retrieve the program by simply touching the key.  
➔ [STORING SCAN OPERATIONS \(Programs\)](#) (page 5-73)
- The functions that can be selected for the customized keys vary depending on the mode.



### System Settings (Administrator): Customize Key Setting

Registration is performed in [System Settings] - [Operation Settings] - "Customize Key Setting" in the Web page menu.

## Checking what special modes are selected

The  key appears in the base screen when a special mode or 2-sided scanning is selected.

The  key can be touched to display the selected special modes. To close the screen, touch the [OK] key.

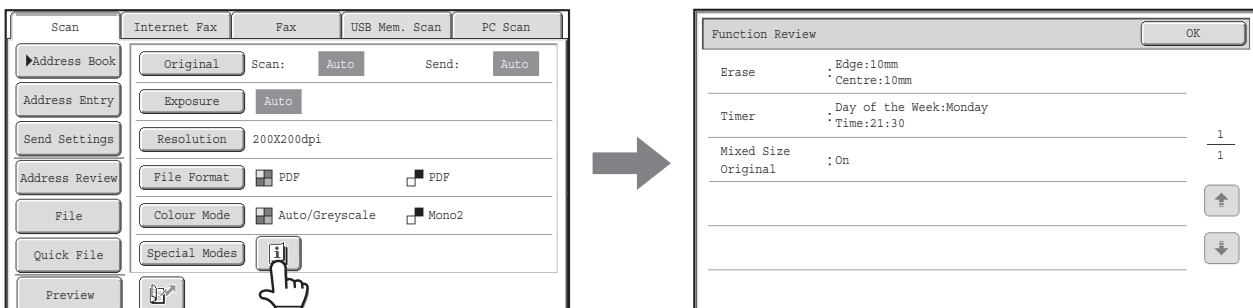

The special mode settings cannot be changed from the review screen. To change a setting, touch the [OK] key to close the review screen and then touch the [Special Modes] key and select the setting that you wish to change.

# ADDRESS BOOK SCREEN

This screen is used to select transmission destinations.

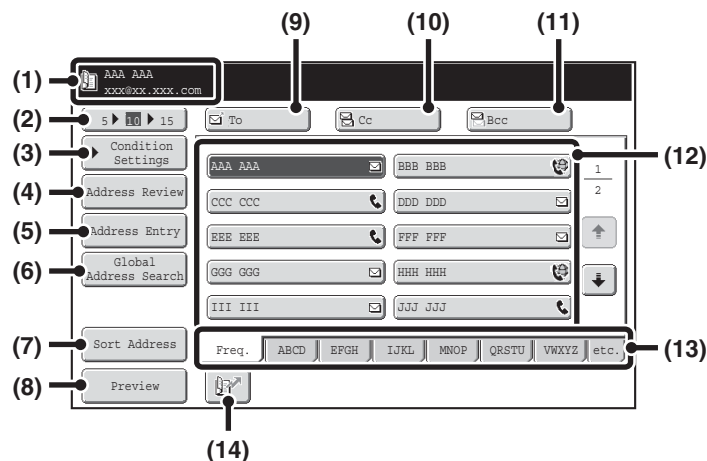

- (1) **This shows the selected destination.**
- (2) **Number of displayed items selector key**  
Touch this key to change the number of destinations (one-touch keys) displayed in the address book screen. Select 5, 10, or 15 keys.
- (3) **[Condition Settings] key**  
Touch this key to select transmission settings. When the key is touched, the base screen appears.  
☞ [BASE SCREEN](#) (page 5-9)
- (4) **[Address Review] key**  
Touch this key to view a list of the selected destinations. Destination selections can be changed.  
☞ [CHECKING AND DELETING THE SELECTED DESTINATIONS](#) (page 5-20)
- (5) **[Address Entry] key**  
Touch this key to manually enter a destination address instead of using a one-touch key.  
☞ [ENTERING AN ADDRESS MANUALLY](#) (page 5-22)
- (6) **[Global Address Search] key**  
When the use of an LDAP server has been enabled in the machine's Web pages, a transmission address can be obtained from a global address book.  
☞ [RETRIEVING A DESTINATION FROM A GLOBAL ADDRESS BOOK](#) (page 5-25)
- (7) **[Sort Address] key**  
Touch to change the index tabs to custom indexes or to display one-touch keys by send mode.  
☞ [CHANGING THE DISPLAY OF ONE-TOUCH KEYS IN THE ADDRESS BOOK SCREEN](#) (page 5-13)
- (8) **[Preview] key\***  
Touch the image that will be sent in the touch panel before transmission.  
☞ [CHECKING THE IMAGE TO BE TRANSMITTED \(Preview\)](#) (page 5-69)  
\* On the MX-2314N, the productivity kit is required.
- (9) **[To] key**  
Touch this key to enter the selected destination (one-touch key).  
☞ [RETRIEVING A DESTINATION](#) (page 5-19)
- (10) **[Cc] key**  
When using Scan to E-mail, touch the [Cc] key when you wish to send a "Carbon copy" of the e-mail to an additional destination.
- (11) **[Bcc] key**  
When using Scan to E-mail, touch the [Bcc] key when you wish to send a "Blind carbon copy" of the e-mail to an additional destination.  
When an address is specified as a Bcc recipient, other recipients will not know that the address is a recipient. This key only appears when Bcc has been enabled using "Bcc Setting" in the system settings (administrator).
- (12) **One-touch key display**  
The destinations (one-touch keys) stored in each index are displayed. This chapter refers to keys in which destinations and groups are stored as one-touch keys.  
☞ [RETRIEVING A DESTINATION](#) (page 5-19)
- (13) **Index tabs**  
Touch this to change the displayed index tab.  
☞ [Index display](#) (page 5-14)
- (14) **Search key**  
Touch this key to specify a destination using a search number\*.  
\* A 4-digit number assigned to a one-touch key or group key when it is stored.  
☞ [USING A SEARCH NUMBER TO RETRIEVE A DESTINATION](#) (page 5-21)

- Icons appear in the one-touch keys in the address book to indicate which mode is used for transmission.
  - [RETRIEVING A DESTINATION FROM THE ADDRESS BOOK](#) (page 5-18)
- For information on storing addresses in the address book, see "[STORING DESTINATION ADDRESSES FOR EACH SCAN MODE IN THE ADDRESS BOOK](#)" (page 5-6).
- For information on storing destinations for Scan to Desktop, see "[STORING A DESTINATION FOR SCAN TO DESKTOP](#)" (page 5-7).

- **System Settings: Address Book** (page 7-16)  
This is used to store Scan to E-mail and Internet fax addresses in one-touch keys.
- **System Settings (Administrator): The Number of Direct Address Keys Displayed Setting**  
This is used to change the default setting for the number of one-touch keys displayed in the address book screen.
- **System Settings (Administrator): Bcc Setting**  
This setting enables or disables Bcc delivery. When enabled, the [Bcc] key appears in the address book screen.
- **System Settings (Administrator): Default Display Settings**  
One of the following screens can be selected for the initial screen that appears when the [IMAGE SEND] key is touched.
  - Base screen of each mode (scan, Internet fax, fax, or data entry mode)
  - Address book screen
 "Default Display Settings" can be set on the displayed screen by touching [Image Send Settings] - [Operation Settings] - [Other Settings].
- **System Settings (Administrator): Address Book Default Selection**  
The following settings are available for the method of sorting the addresses that appear in the address book.
  - Index type (alphabetical, custom)
  - Address type (all, group, E-mail, FTP/Desktop, Network Folder, Internet fax, fax)

## CHANGING THE DISPLAY OF ONE-TOUCH KEYS IN THE ADDRESS BOOK SCREEN

You can show destinations of only a specific transmission mode in the address book screen, or change the displayed index tabs from the alphabetical tabs to the custom tabs. The procedure for selecting destinations does not change.

1

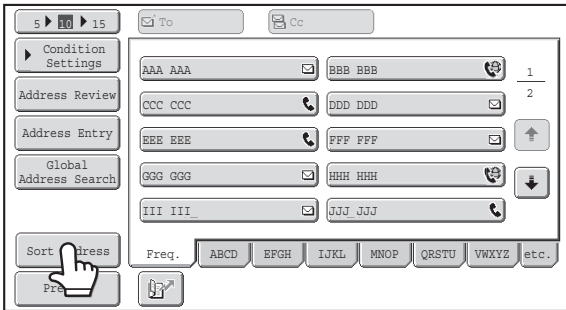

**Touch the [Sort Address] key.**

2

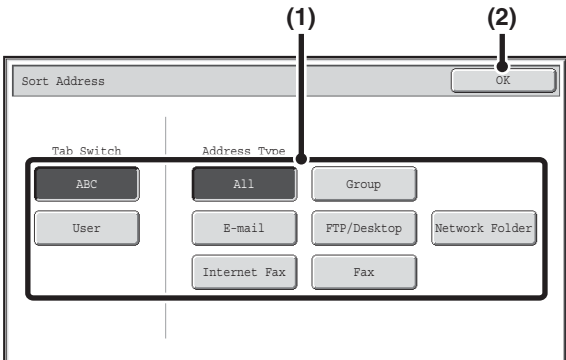

**Change the display mode.**

**(1) Touch the key of the mode or tab that you wish to display.**

- To show only the one-touch keys of a particular send mode, touch the desired mode key under "Address Type".
- To change the index tabs to the custom indexes, touch the [User] key under "Tab Switch".

**(2) Touch the [OK] key.**



## Index display

Indexes make it easy to search for a destination (one-touch key). The destinations are displayed separately using alphabetical search characters and index numbers. To display a stored destination, touch the appropriate index tab. It is convenient to store frequently used destinations in the [Freq.] index. Specify that a destination be displayed in the [Freq.] index when you store the destination.

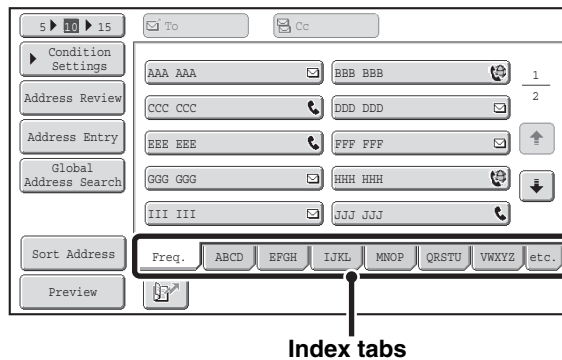

The destinations can also be displayed in alphabetical order by initial. Each time the displayed index tab is touched, the display order changes in the following order: search numbers (page 5-21), ascending names, descending names. When the display order is changed, the display order of the other index tabs also changes.

Ordered by search number (default)



Ascending names



Descending names



Index names can be changed using "Custom Index" in the system settings, allowing you to create groups of one-touch keys that can be easily recognized.



### System Settings: [Storing group keys \(page 7-18\)](#)

This setting is used to store custom index names. The custom index where a one-touch key appears is specified when the transmission destination is stored in the key.

### Narrowing the search letter range

An alphabet tab on an index tab can be touched to display keys to further narrow the search range. For example, when the [ABCD] tab is touched, keys from "A" to "D" appear. If the [B] key is touched, only destinations starting with the letter "B" will appear. To cancel, touch the key again. Note that the search letter range cannot be narrowed on the [Freq.] tab, the [etc.] tab, or on a user index tab.

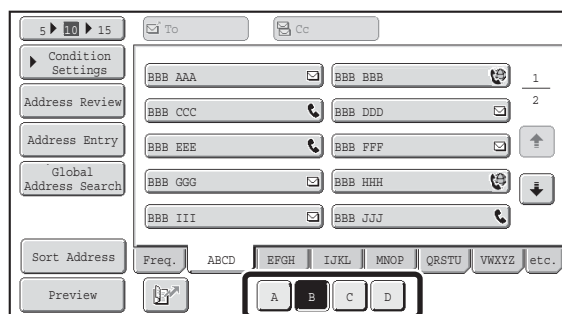

# SCAN SEND SEQUENCE

This section explains the basic procedure for scanning and transmission. Select settings in the order shown below to ensure smooth transmission.

For the detailed procedures for selecting the settings, see the explanation of each setting in this chapter.

## Place the original.

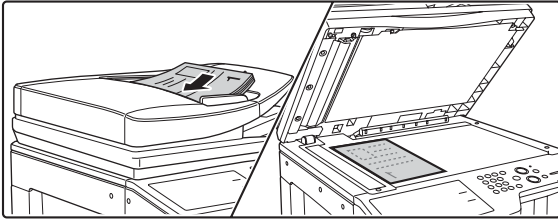

Place the original in the document feeder tray of the automatic document feeder, or on the document glass.

- [SENDING AN IMAGE IN SCAN MODE](#) (page 5-28)
- [SENDING AN IMAGE IN USB MEMORY MODE](#) (page 5-35)
- [SENDING A FAX IN INTERNET FAX MODE](#) (page 5-41)



## Enter the destination

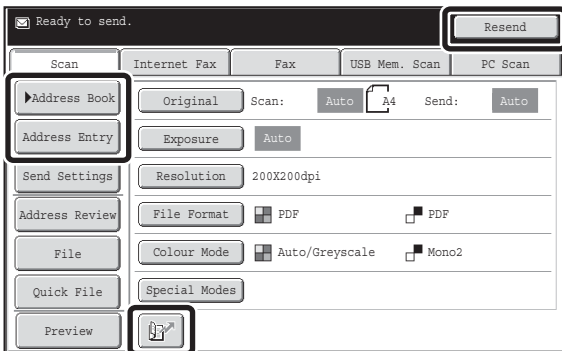

Specify the destination of the scan transmission.

- [Address Book] key:
  - [RETRIEVING A DESTINATION FROM THE ADDRESS BOOK](#) (page 5-18)
  - [RETRIEVING A DESTINATION FROM A GLOBAL ADDRESS BOOK](#) (page 5-25)
- [Address Entry] key:
  - [ENTERING AN ADDRESS MANUALLY](#) (page 5-22)
- [Image] key:
  - [USING A SEARCH NUMBER TO RETRIEVE A DESTINATION](#) (page 5-21)
- [Resend] key:
  - [USING THE RESEND FUNCTION](#) (page 5-27)



## Select settings

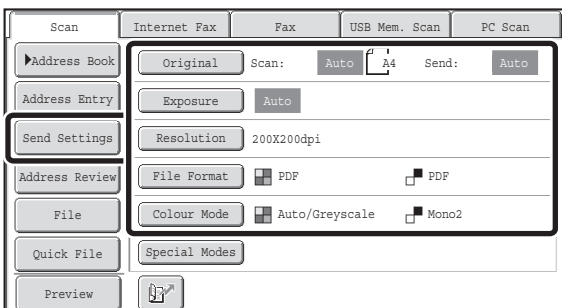

Settings can be selected for scanning the original.

- Original (2-sided original, scan size, send size)
- Exposure • Resolution • File Format • Colour Mode
  - [IMAGE SETTINGS](#) (page 5-53)
- Send Settings (File Name)
  - [CHANGING THE SUBJECT, FILE NAME, REPLY-TO, AND BODY TEXT\\*](#) (page 5-32)
- USB memory mode:
  - [ENTERING A FILE NAME](#) (page 5-40)
- Internet fax mode:
  - [CHANGING THE SUBJECT, FILE NAME, AND BODY TEXT](#) (page 5-44)



## Special mode settings

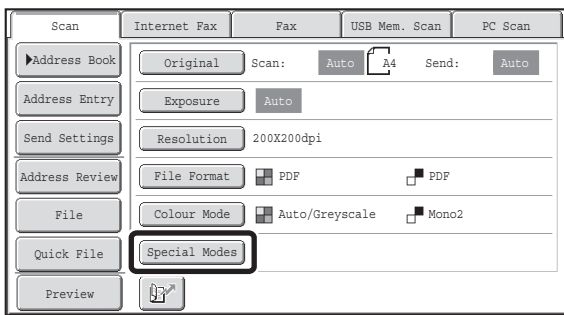

Special modes can be selected.

**SPECIAL MODES** (page 5-71)



## Start scanning and transmission

Start scanning and transmission.

If the original is placed on the document glass, follow these steps to start scanning and transmission:

- (1) Press the [COLOUR START] key or the [BLACK & WHITE START] key.
- (2) When scanning is finished, replace the original with the next original.
- (3) Press the [COLOUR START] key or the [BLACK & WHITE START] key.
- (4) Repeat (2) and (3) until all originals have been scanned.
- (5) Touch the [Read-End] key.



- The [COLOUR START] key cannot be used in Internet fax mode.
- After the original is scanned, the settings revert to the default settings.



### To cancel scanning...

Press the [STOP] key ( ) to cancel the operation.



### System Settings (Administrator): Default Display Settings

The settings can be kept in effect a fixed period of time after scanning is completed.

# ORIGINAL SIZES

## TRANSMITTABLE ORIGINAL SIZES

The following original sizes can be transmitted

	Minimum original size	Maximum original size
Using the automatic document feeder	131 mm (height) x 140 mm (width) (5-1/8" (height) x 5-1/2" (width))	297 mm (height) x 1000 mm* (width) (11-5/8" (height) x 39-3/8"* (width))
Using the document glass	–	297 mm (height) x 432 mm (width) (11-5/8" (height) x 17" (width))

\* A long original can be transmitted. (When only scan destinations are selected for scan transmission or metadata transmission, scanning will take place in Mono2 at a resolution of 300X300dpi or less. When a resolution of 600X600dpi is used for Internet fax transmission, the maximum original size is 800 mm (31-1/2").)

## THE SIZE OF THE PLACED ORIGINAL

When a standard size original is placed, the original size is automatically detected and displayed in "Scan" in the base screen. When the automatic original detection function is operating and the original is a non-standard size, the closest standard size may be displayed or the original size may not appear. In this event, manually set the correct original size.

- ☞ [Specifying the original scan size \(by paper size\)](#) (page 5-56)
- ☞ [Specifying the original scan size \(by numerical values\)](#) (page 5-57)

## STANDARD SIZES

Standard sizes are sizes that the machine can automatically detect. The standard sizes are set in "Original Size Detector Setting" in the system settings (administrator).

List of original size detector settings

Selections	Standard sizes (detected original sizes)	
	Document glass	Document feeder tray (automatic document feeder)
AB-1	A3, A4, A4R, A5, B4, B5, B5R	A3, A4, A4R, A5, B4, B5, B5R, 8-1/2" x 11", 8-1/2" x 14", 11" x 17"
AB-2	A3, A4, A4R, A5, B5, B5R, 216 mm x 330 mm (8-1/2" x 13")	A3, A4, A4R, A5, B4, B5, B5R, 8-1/2" x 11", 11" x 17", 216 mm x 330 mm (8-1/2" x 13")
AB-3	A4, A4R, A5, B4, 8K, 16K, 16KR	A3, A4, A4R, A5, B4, 8K, 16K, 16KR, 8-1/2" x 11", 11" x 17", 216 mm x 330 mm (8-1/2" x 13")
AB-4	A3, A4, A4R, A5, B5, B5R, 216 mm x 340 mm (8-1/2" x 13-2/5")	A3, A4, A4R, A5, B4, B5, B5R, 8-1/2" x 11", 11" x 17", 216 mm x 340 mm (8-1/2" x 13-2/5")
AB-5	A3, A4, A4R, A5, B5, B5R, 216 mm x 343 mm (8-1/2" x 13-1/2")	A3, A4, A4R, A5, B4, B5, B5R, 8-1/2" x 11", 11" x 17", 216 mm x 343 mm (8-1/2" x 13-1/2")
Inch-1	11" x 17", 8-1/2" x 14", 8-1/2" x 11", 8-1/2" x 11"R, 5-1/2" x 8-1/2"	11" x 17", 8-1/2" x 14", 8-1/2" x 11", 8-1/2" x 11"R, 5-1/2" x 8-1/2", A4, A3
Inch-2	11" x 17", 8-1/2" x 13" (216 mm x 330 mm), 8-1/2" x 11", 8-1/2" x 11"R, 5-1/2" x 8-1/2"	11" x 17", 8-1/2" x 13" (216 mm x 330 mm), 8-1/2" x 11", 8-1/2" x 11"R, 5-1/2" x 8-1/2", A4, A3
Inch-3	11" x 17", 8-1/2" x 13-2/5" (216 mm x 340 mm), 8-1/2" x 11", 8-1/2" x 11"R, 5-1/2" x 8-1/2"	11" x 17", 8-1/2" x 13-2/5" (216 mm x 340 mm), 8-1/2" x 11", 8-1/2" x 11"R, 5-1/2" x 8-1/2", A4, A3

# ENTERING DESTINATIONS





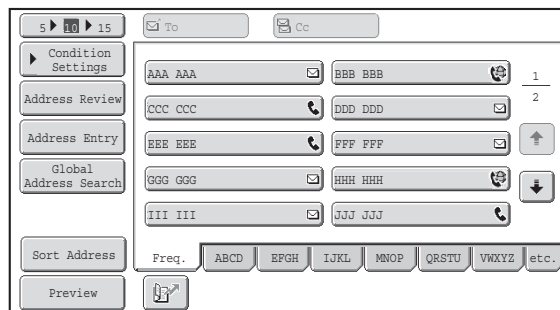

This section explains how to specify destination addresses, including selecting an address from the address book and retrieving an address by entering a search number.

## RETRIEVING A DESTINATION FROM THE ADDRESS BOOK

The address book screen shows stored destinations as one-touch keys. The destinations are displayed in order by search number.



The address book screen shows the destinations of all modes of the image send function. Each one-touch key shows the name of the destination and an icon indicating the mode to be used.

Icon	Mode
	Fax
	Scan to E-mail
	Internet fax (Direct SMTP)
	Scan to FTP
	Scan to Network Folder
	Scan to Desktop
	Group key with multiple destinations



- For information on storing addresses in the address book, see "[STORING DESTINATION ADDRESSES FOR EACH SCAN MODE IN THE ADDRESS BOOK](#)" (page 5-6).
- For information on storing destinations for Scan to Desktop, see "[STORING A DESTINATION FOR SCAN TO DESKTOP](#)" (page 5-7).



### System Settings: [Address Book](#) (page 7-16)

This is used to store Scan to E-mail and Internet fax addresses in one-touch keys.

# RETRIEVING A DESTINATION

A destination is retrieved by selecting its one-touch key.

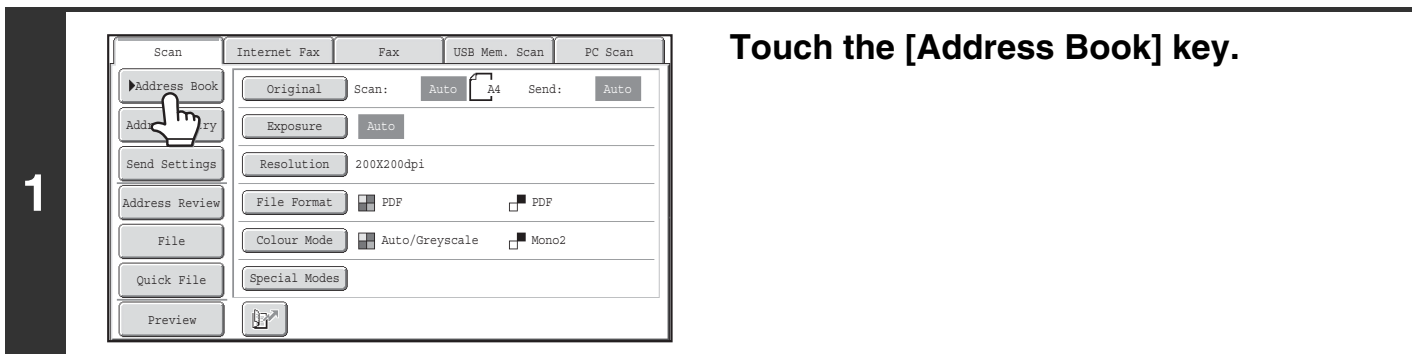

Touch the [Address Book] key.

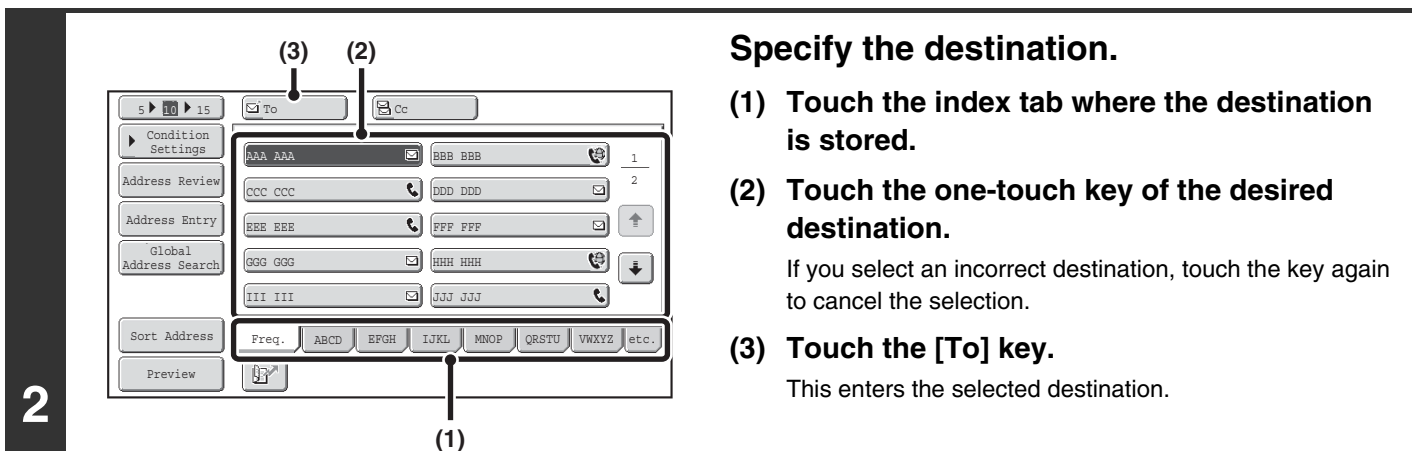

Specify the destination.

(1) Touch the index tab where the destination is stored.

(2) Touch the one-touch key of the desired destination.

If you select an incorrect destination, touch the key again to cancel the selection.

(3) Touch the [To] key.

This enters the selected destination.



- It is convenient to store frequently used destinations in the [Freq.] index. Specify that a destination be displayed in the [Freq.] index when you store the destination.

- To continue specifying other destinations...**

It is possible to specify multiple scan mode (Scan to E-mail, Scan to FTP, Scan to Desktop, Scan to Network Folder), Internet fax, and fax mode destinations when performing a broadcast transmission (maximum of 500 destinations). To specify multiple destinations, repeat (1) through (3) of this step.

When performing Scan to E-mail, you can select a one-touch key and then touch the [Cc] key or the [Bcc] key to send Cc or Bcc copies of the e-mail.



- System Settings (Administrator): Bcc Setting**

This setting enables or disables Bcc delivery. When enabled, the [Bcc] key appears in the address book screen.

- System Settings (Administrator): Must Input Next Address Key at Broadcast Setting**

This setting determines whether or not the [Next Address] key can be omitted before specifying the next destination. Factory default setting: the [Next Address] key can be omitted.

- System Settings (Administrator): Disable Switching of Display Order**

This is used to disable switching of the order of display of the one-touch keys in the address book screen. The currently selected display order will be the order that is used after this setting is enabled.

# CHECKING AND DELETING THE SELECTED DESTINATIONS

When multiple destinations have been selected, you can display and check the destinations. You can also delete a destination from the list (cancel selection of the destination).

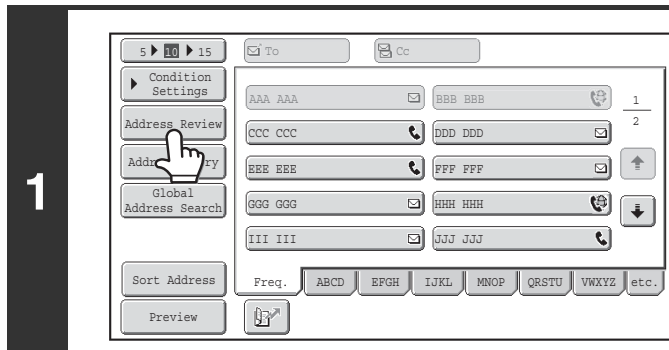

Touch the [Address Review] key.

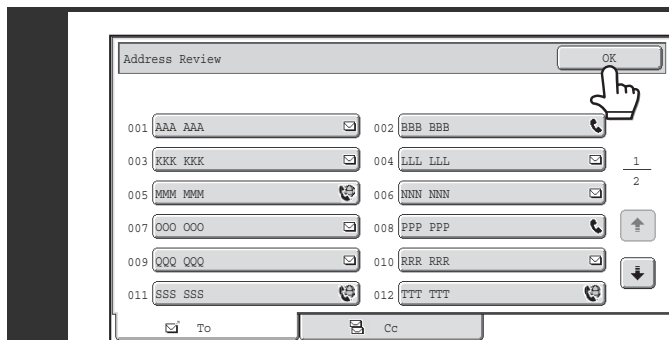

Check the destinations and then touch the [OK] key.

**2** To check Cc or Bcc destinations, touch the corresponding tab.

**2** **To cancel selection of a destination...**  
Touch the one-touch key of the destination that you wish to cancel. A message will appear to confirm the deletion. Touch the [Yes] key. Touch the [Detail] key to check the specified destination type and name.

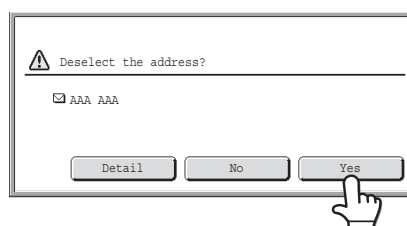

# USING A SEARCH NUMBER TO RETRIEVE A DESTINATION

A destination stored in the address book can be retrieved using the  key. This can be done in the base screen of any of the modes or in the address book screen.

1

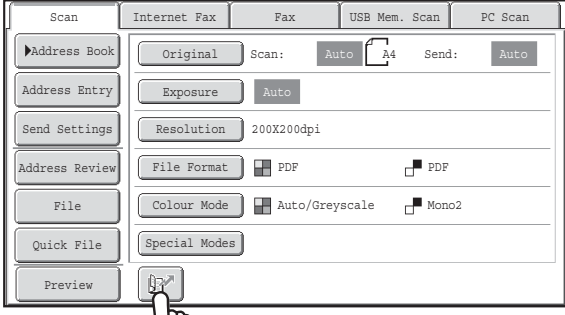

**Touch the  key.**

2

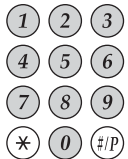



**Enter the 4-digit search number of the address with the numeric keys.**

When the 4-digit search number is entered, the stored address is retrieved and specified as a destination.

---

2

-  • The search number is programmed when the destination is stored in the address book.
- If you do not know the search number, print the one-touch address list using "Sending Address List" in the system settings.
- When entering search numbers such as "0001" and "0011", "0" can be omitted. For example to enter "0001", enter "1" and touch the  key or the [Next Address] key.

** If an incorrect search number is entered...**

Press the [CLEAR] key () to clear the number and enter the correct number.



# ENTERING AN ADDRESS MANUALLY

Scan to E-mail, Internet fax, Network Folder and data entry mode addresses can be manually entered.

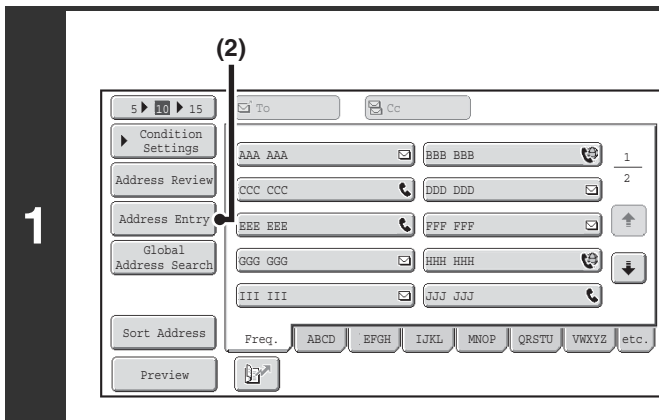

## Display the address input screen.

- (1) Touch the [Address Book] key in the base screen.

Before touching the [Address Entry] key in the base screen, touch the tab of the mode that you wish to use.

- (2) Touch the [Address Entry] key.

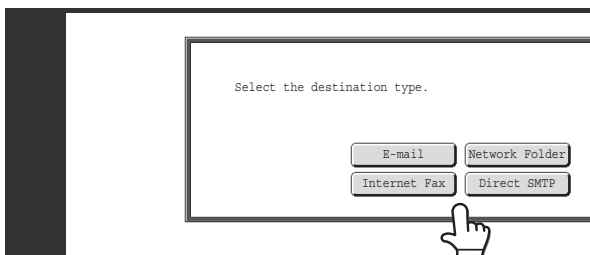

## Enter the destination address.

- (1) Touch the key of the desired delivery method.

- Touch the [E-mail] key to open the delivery method selection screen. Normally the [To] key is touched.
- Touch the [Network Folder] key to open the network folder entry screen. To specify a network folder, see "[SPECIFYING A NETWORK FOLDER](#)" (page 5-23).
- If you touched the [Address Entry] key in the base screen in step 1, the delivery methods that can be selected vary depending on the mode being used.

- (2) Enter the destination address in the text entry screen that appears.

Enter the destination address and touch the [OK] key. For the procedure for entering text, see "[ENTERING TEXT](#)" (page 1-70) in "1. BEFORE USING THE MACHINE".



- If you wish the destination to be a Cc destination, touch the [Cc] key.
- The [Bcc] key only appears when Bcc has been enabled using "Bcc Setting" in the system settings (administrator). If you wish the destination to be a Bcc destination, touch the [Bcc] key.
- When Internet fax mode is selected, the base screen appears after the destination address is entered. However, if "I-Fax Reception Report On/Off Setting" is enabled in the system settings (administrator), the reception report request screen will appear. If you wish to receive a report, touch the [Yes] key. If not, touch the [No] key. (When Direct SMTP is used, transmission confirmation is not performed.)



### System Settings (Administrator): I-Fax Reception Report On/Off Setting

This setting is used to request a reception report when an Internet fax is sent. When the destination is specified by directly entering the address, a message will appear asking you if you wish to receive a report. (When Direct SMTP is used, transmission confirmation is not performed.)

### System Settings (Administrator): Bcc Setting

This setting enables or disables Bcc delivery. When enabled, the [Bcc] key appears in the address book screen and the delivery type selection screen.

# SPECIFYING A NETWORK FOLDER

A network folder on a server or computer connected to the same network as the machine can be directly specified. Select [Network Folder] in step 2 on the previous page and follow the steps below.

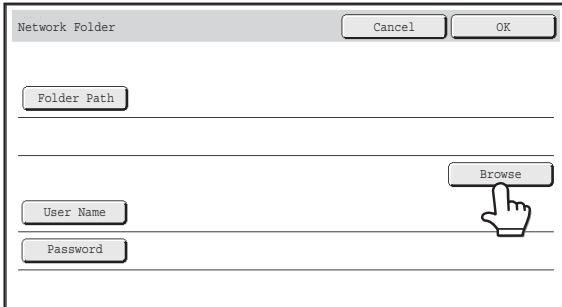
**1**

## Touch the [Browse] key.

- To directly enter a folder, touch the [Folder Path] key. A text entry screen will appear.
- If a user name and password are required, check with the administrator of the server and enter the user name and password.



For the procedure for entering text, see "[ENTERING TEXT](#)" (page 1-70) in "1. BEFORE USING THE MACHINE".

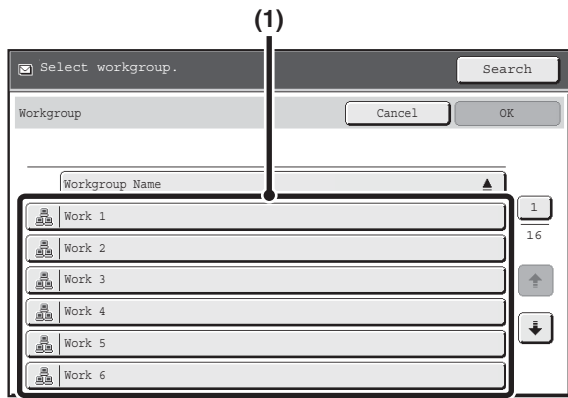

## Access the network folder.

- (1) Touch the key of the workgroup that you wish to access.

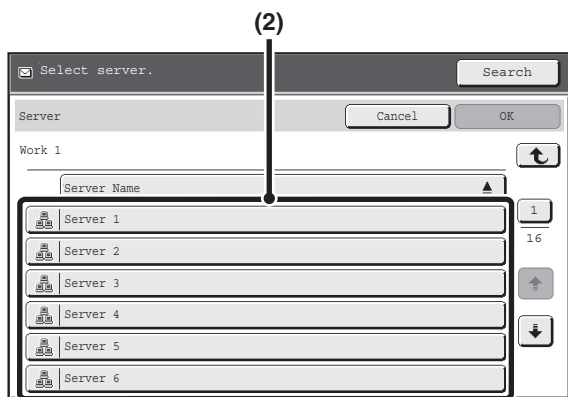

- (2) Touch the key of the server or computer that you wish to access.

If a screen appears prompting you to enter a user name and password, check with your server administrator and enter the appropriate user name and password.

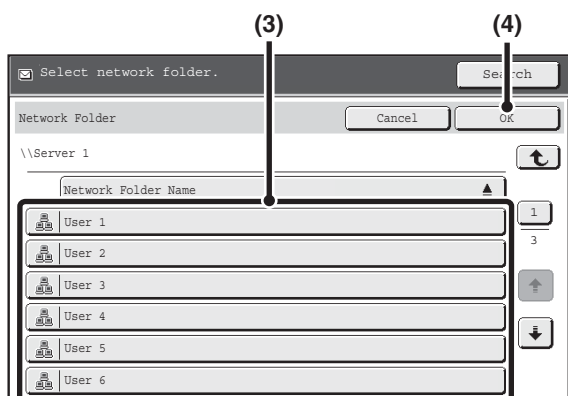





- (3) Touch the key of the network folder.

- (4) Touch the [OK] key.

You will return to the screen of step 1. Touch the [OK] key again to enter the folder.



- You can touch the [Search] key and enter a keyword to search for a workgroup, server, or network folder. For the procedure for entering text, see "ENTERING TEXT" (page 1-70) in "1. BEFORE USING THE MACHINE".
- Up to 100 workgroups, 100 servers, and 100 network folders can be displayed.
- To move up one level, touch the  key.
- The [Cancel] key can be pressed to return to the screen of step 1.
- To change the sorting order of the displayed keys, touch the key that shows  or  in each screen. The order switches between ascending order and descending order each time you touch the key.
- To go to a particular page, touch the  key that shows the current page number and enter the desired page number.

# RETRIEVING A DESTINATION FROM A GLOBAL ADDRESS BOOK

When an LDAP server is configured in the Web pages, you can look up an address in a global address book and retrieve the address for Scan to E-mail or Internet fax transmission (excluding Direct SMTP addresses).

1

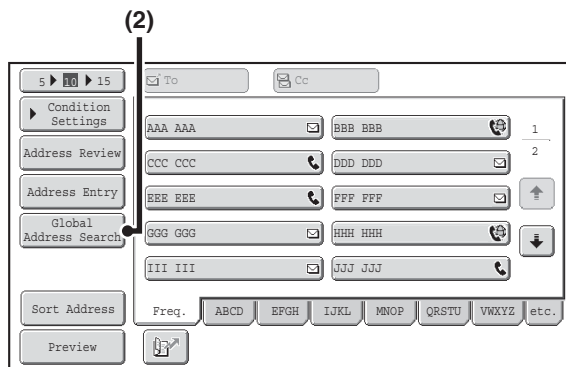

Open the global address search screen.

- (1) Touch the [Address Book] key in the base screen.
- (2) Touch the [Global Address Search] key.

2

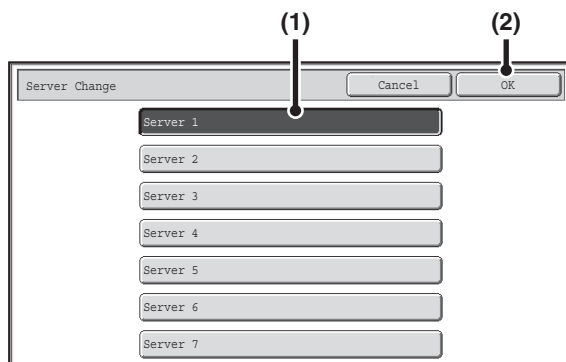

Search for the destination.

If only one LDAP server has been stored, (1) and (2) are not necessary. Go directly to (3). If an authentication screen for the LDAP server appears, enter your user name and password.

- (1) Touch the key of the LDAP server that you wish to use.  
If an authentication screen for the LDAP server appears, enter your user name and password.
- (2) Touch the [OK] key.
- (3) Search for the destination in the search screen.

Enter search characters for the destination and touch the [Search] key. The search results will appear after a brief interval.

For the procedure for entering text, see "[ENTERING TEXT](#)" (page 1-70) in "1. BEFORE USING THE MACHINE".



## How to search

Enter the search characters (maximum of 64 characters). The system will look for names starting with the entered letters.

An asterisk \* can be used as follows:

XXX\*: Names beginning with "XXX".

\*XXX: Names that end with "XXX".

\*XXX\*: Names that include "XXX".

AA\*XX: Names that start with "AA" and end with "XX".

3

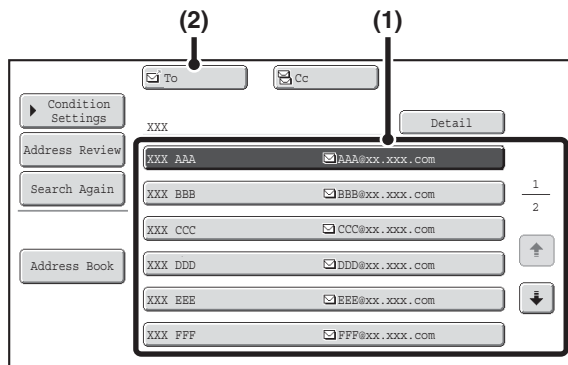

## Select the destination.

### (1) Touch the key of the desired destination.

If no names are found that match the search characters, a message will appear. Touch the [OK] key to close the message and touch the [Search Again] key to search again.

### (2) Touch the [To] key.

This enters the selected destination.

If you wish to enter another destination, repeat (1) and (2) of this step.



- If 30 or more matches are found, a message will appear in the screen. Touch the [OK] key to close the message. Up to 300 matches can appear. If no names are found that match the search letters, touch the [Search Again] key to search again using more search letters.
- **To check the information stored in a destination...**  
Touch the key of the destination and then touch the [Detail] key. The information stored for the selected destination will appear. Check the information and then touch the [OK] key to return to the search results screen.
- **If a screen for selecting the item to be used appears...**  
If the selected destination includes a fax number, telephone number, or other contact information in addition to the e-mail address or Internet fax address, you will need to select which item you wish to use. Touch the [E-mail] key or the [Internet Fax] key to retrieve the address for Scan to E-mail or Internet fax transmission.

## Storing a destination from a global address book in the machine's address book

A destination address obtained from a global address book can be stored as a destination (one-touch key) in the address book of the machine.

Touch the [Detail] key in the search results screen of the global address book (the screen of step 3 above) to display information on the selected destination. Touch the [Register] key in the detailed information screen and then touch the item to be used (the [E-mail] key or the [Internet Fax] key). The following screens will appear.

### E-mail address registration screen

Direct Address / Individual		Exit
<input checked="" type="checkbox"/> E-mail	<input type="checkbox"/> Internet Fax	<input type="checkbox"/> Fax
Search Number	001	
Name	AAA AAA	
Initial	A	Index User 1
Address	AAA@xx.xxx.com	
Key Name	AAA AAA	
File Format	Colour/Greyscale:PDF/Medium	
	B/W	:PDF/MMR (G4)

### Internet fax address registration screen

Direct Address / Individual		Exit
<input type="checkbox"/> E-mail	<input checked="" type="checkbox"/> Internet Fax	<input type="checkbox"/> Fax
Search Number	001	
Name	AAA AAA	
Initial	A	Index User 1
Address	AAA@xx.xxx.com	
Key Name	AAA AAA	
Compression	MH (G3)	
I-Fax Report	Off	

The information stored in the global address book is automatically entered. (The settings can be changed if needed. For detailed information on each item, see "[Address Control](#)" (page 7-16) in "7. SYSTEM SETTINGS".) However, configure the items below manually. To complete the storing procedure, touch the [Exit] key.

- [Initial] key: Touch this key to enter the initials that determine where the destination will appear in the alphabetical index and the order of one-touch key display. Enter up to 10 characters for the initials.
- [Index] key: Touch this key to select the custom index in which the address will appear. You can also select whether or not the destination will be included on the [Freq.] tab of the address book.
- [File Format] key: Set the format for Scan to E-mail. Default format settings have already been configured; however, selecting format settings when you store a destination saves you the trouble of selecting the settings each time you transmit to that destination.
- [Compression] key: Touch this key to set the compression mode when sending an Internet fax.
- [I-Fax Report] key: Touch this key to request a reception report when sending an Internet fax.

# USING THE RESEND FUNCTION

The destinations of the most recent 8 transmissions by Scan to E-mail, Internet fax (including Direct SMTP addresses) and/or fax are stored. One of these can be selected to resend to that destination.

1

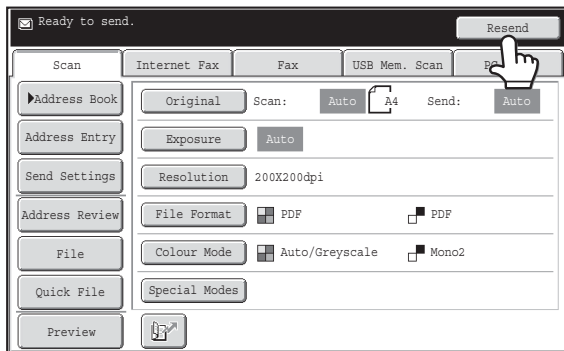

Touch the [Resend] key.

2

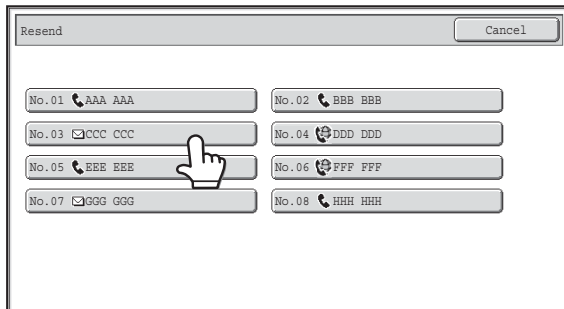

Touch the key of the desired address.

The last 8 addresses used for transmission are displayed.



- When the [Resend] key is touched and a destination selected, the mode of the selected destination is automatically selected.
- The following types of addresses are not stored for resending.
  - A one-touch key in which multiple destinations are stored (group key).
  - Scan to FTP, Scan to Desktop, and Scan to Network Folder addresses.
  - Broadcasting destinations
  - Addresses used only for BCC delivery
  - Destinations transmitted to using a program



#### System Settings (Administrator): Disable [Resend] on Fax/Image Send Mode

This prohibits use of the resend function. When this setting is enabled, the [Resend] key cannot be used in the base screen of image send mode.

# TRANSMITTING AN IMAGE

## SENDING AN IMAGE IN SCAN MODE

This section explains the basic procedure for transmission in scan mode (Scan to E-mail, Scan to FTP, Scan to Desktop, and Scan to Network Folder).



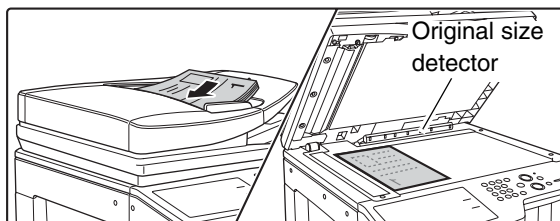

- When a default address is configured in "Default Address Setting" in the system settings (administrator), the mode cannot be changed, the destination cannot be changed, and destinations cannot be added. If you wish to change the mode or destination, touch the [Cancel] key in the touch panel and then follow the procedure below.  
When "Default Address Setting" is set to "Apply E-mail address of the user for login.", pressing the [Add Address] key on the touch panel switches modes and adds addresses.
- If the [Apply also for Fax/I-Fax Screen] checkbox is set to , the [Add Address] key does not appear when destinations are added in fax or Internet fax mode screen, and then the mode is switched to scanner/image send mode. Destinations can be added using the [Address Book] key, [Address Entry] key, or the  key.



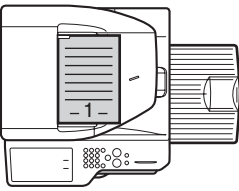
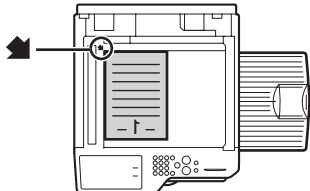

### Place the original.

Do not place any objects under the original size detector. Closing the automatic document feeder with an object underneath may damage the original size detector plate and prevent correct detection of the document size.

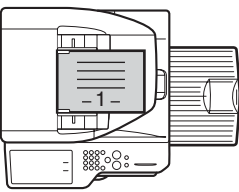
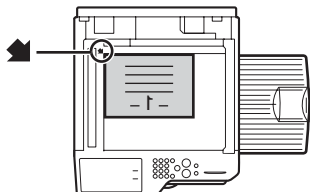
- When placing the originals, orient them as shown below.

Originals	Document feeder tray Place the original face up.	Document glass Place the original face down and align the corner with the tip of the arrow mark  in the top left corner of the document glass scale.
Portrait orientation* 		
Landscape orientation 		

- \* To place a large portrait-oriented original, place it as shown above in "Landscape orientation" and specify the placement orientation in step 3.
- Place A5 (5-1/2" x 8-1/2") size originals in portrait (vertical) orientation (). If placed in landscape (horizontal) orientation () , an incorrect size will be detected. For a A5R (5-1/2" x 8-1/2"R) size original, enter the original size manually.
- Originals cannot be scanned in succession from both the automatic document feeder and the document glass and sent in a single transmission.

2

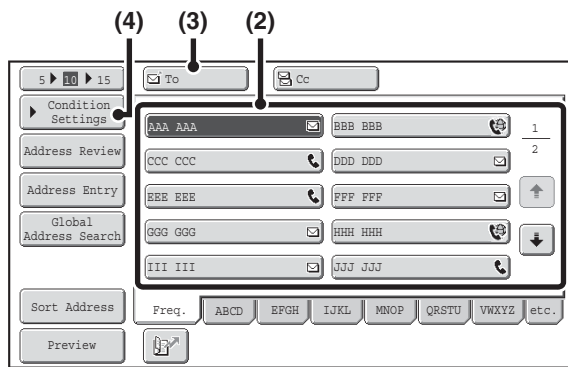

### Specify the destination.

(1) Touch the [Address Book] key in the base screen.

(2) Touch the one-touch key of the desired destination.

The icon on the key indicates the type of destination stored in the key.

: Scan to E-mail

: Scan to FTP

: Scan to Network Folder

: Scan to Desktop

(3) Touch the [To] key.

The destination is specified.

(4) Touch the [Condition Settings] key.



- After a one-touch key is touched, if the screen is changed without touching the [To] key, the destination is automatically specified.
- When performing Scan to E-mail, you can also send Cc or Bcc copies to other destinations. Touch the desired destination and then touch the [Cc] key or the [Bcc] key.
- Multiple destinations can be specified. To specify multiple destinations, repeat steps (2) and (3).
- You can also select multiple one-touch keys and then touch the [To] key (or the [Cc] or [Bcc] key) to specify all selected keys at once.
- In addition to specification by a one-touch key, a destination can also be specified by a search number. Destinations for Scan to E-mail and Scan to Network Folder can also be manually entered or looked up in a global address book. For more information, see "[ENTERING DESTINATIONS](#)" (page 5-18).



#### System Settings (Administrator): Bcc Setting

This setting enables or disables Bcc delivery. When enabled, the [Bcc] key appears in the address book screen.

3

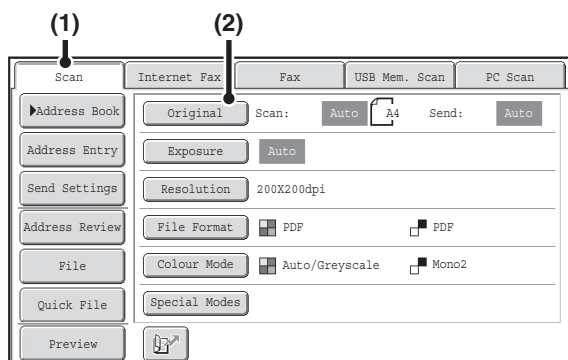

### Switch to scan mode and display the image settings screen.

(1) Touch the [Scan] tab.

(2) Touch the [Original] key.



The current settings for [Original], [Exposure], [Resolution], [File Format], and [Colour Mode] are indicated at the right of each key. To change a setting, touch the appropriate key.

- [AUTOMATICALLY SCANNING BOTH SIDES OF AN ORIGINAL \(2-Sided Original\)](#) (page 5-54), [SPECIFYING THE ORIGINAL SCAN SIZE AND SEND SIZE \(Enlarge/Reduce\)](#) (page 5-55), [CHANGING THE EXPOSURE AND ORIGINAL IMAGE TYPE](#) (page 5-61), [CHANGING THE RESOLUTION](#) (page 5-63), [CHANGING THE FILE FORMAT](#) (page 5-64), [CHANGING THE COLOUR MODE](#) (page 5-68), [SPECIAL MODES](#) (page 5-71)



4

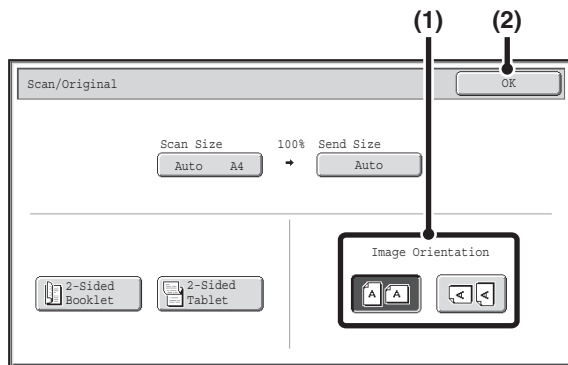

### Specify the orientation in which the original is placed.

To enable the original to be scanned in the correct orientation (the orientation of the top edge of the original that is shown at the top of the display), specify the orientation in which the original was placed in step 1.

#### (1) Touch the appropriate orientation key.

If the top edge of the original is up, touch the key. If the top edge of the original is to the left, touch the key.

#### (2) Touch the [OK] key.

You will return to the screen of step 2.



The original orientation is initially set to . If the original was placed with the top edge up, this step is not necessary.

5

### Press the [COLOUR START] key or the [BLACK & WHITE START] key.

Scanning begins.

- If the original is placed on the document glass, the [Read-End] key appears in the touch panel. If the original is only one page, go to step 7. To scan more pages, go to the next step.
- If the original was inserted in the document feeder tray, a beep will sound when scanning is completed and transmission will take place.



- To scan in full colour, press the [COLOUR START] key. To scan in black and white, press the [BLACK & WHITE START] key. If the colour mode of the [COLOUR START] key is set to [Auto], the colour of the original will be detected automatically and scanning in full colour, greyscale or Mono2 will take place.
- If Encrypt PDF is selected for the file format, you will be prompted to enter a password when you press the [START] key.



Touch the [Entry] key to open the keyboard screen, enter a password (maximum of 32 characters), and touch the [OK] key. The recipient must use the password entered here to open the Encrypt PDF file.

To cancel Encrypt PDF, touch the [Cancel] key. The format settings screen will appear to let you change the file type. Select a new file type and press the [START] key to begin transmission.

6

### If the original was placed on the document glass, replace it with the next original and press the [COLOUR START] key or the [BLACK & WHITE START] key.

Repeat until all originals have been scanned.

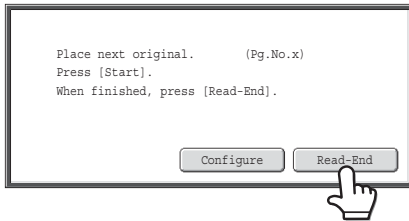

## Touch the [Read-End] key.

A beep will sound to indicate that the operation is completed. Open the automatic document feeder and remove the original.



- If no action is taken for one minute after the confirmation screen appears, scanning automatically ends and the transmission is reserved.
- The [Configure] key can be touched to change the exposure, resolution, scan size, and send size for each original page scanned. However, when "Card Shot" is selected in the special modes, only the exposure can be changed when scanning an even-numbered original page.



- When all originals have been scanned, "Job stored." will be displayed together with a job control number. This number can be used to locate the job in the Transaction Report or in the Image Sending Activity Report. If the job is a broadcast transmission, this number will also appear in the key of the job in the job status screen. For this reason, making a note of the number is useful for checking the result.
- If the memory becomes full while the originals are being scanned, a message will appear and scanning will stop.
- When performing Scan to E-mail, take care not to send a file that is too large. In particular, multi-page files tend to be large. When sending a multi-page file or other large file, it may be necessary to reduce the number of scanned pages or reduce the send size.
- **Storing a mail signature**  
You can have preset text automatically added at the end of e-mail messages as a mail signature. This is convenient when you wish to have a corporate policy or other preset text appear at the bottom of e-mail messages. To store the text for the mail signature, click [Application Settings], [Network Scanner Settings] and then [Administration Settings] in the Web page menu. (Administrator rights are required.) Up to 900 characters can be entered. (The mail signature is not included in the maximum number of characters that can be entered in the e-mail message.)  
Use "Pre-Setting Mail Signature" in the system settings (administrator) to specify whether or not a mail signature is added.



### To cancel scanning...

Press the [STOP] key (⏹) to cancel the operation.



- **System Settings (Administrator): Image Send Settings**  
Use this to configure scanner transmission settings, including the default resolution and exposure settings, the default colour mode and file format, the file compression method for broadcasting, the file size limit for Scan to E-mail, and the default sender and destination.
- **System Settings (Administrator): Pre-Setting Mail Signature**  
Use this setting to specify whether or not a mail signature is added at the end of e-mail messages. By factory default, a mail signature is not added.

# CHANGING THE SUBJECT, FILE NAME, REPLY-TO, AND BODY TEXT\*

The subject, file name, reply-to, and body text can be changed when performing a scan transmission. Preset items can be selected or text can be directly entered.

\* On the MX-2314N, the productivity kit is required.

- When performing Scan to FTP, Scan to Desktop, or Scan to Network Folder, only the file name is used.
- If the subject and file name are not changed, the settings in the Web page are used.
- If the sender name is not changed, the name set in "Default Sender Set" in the system settings is used. If this is not configured, the reply address in [Network Settings] - [Services Settings] - [SMTP Settings] in the Web pages is used. (Administrator rights are required.)
- Selections for the subject, file name, and body text are configured by clicking [Application Settings] and then [Network Scanner Settings] in the Web page menu.
- For the procedure for entering text, see "ENTERING TEXT" (page 1-70) in "1. BEFORE USING THE MACHINE".

1

## Touch the [Send Settings] key in the base screen.

➡ **BASE SCREEN** (page 5-9)

If you are sending to a Scan to FTP, Scan to Desktop, or Scan to Network Folder destination, go to step 4.

2

To change the subject, touch the [Subject] key.

3

Enter the subject.

(1) Touch a Pre-Set text key.

(2) Touch the [OK] key.



- If you wish to directly enter the text, touch the [Direct Entry] key to open the text entry screen. Enter the text and touch the [OK] key.
- The text in a pre-set text key can be edited by touching the pre-set text key and then the [Direct Entry] key. The text entry screen will appear with the selected pre-set text entered. (When a destination is stored using the Web pages, up to 80 characters can be entered. However, only 54 characters can be entered in the touch panel.)

4

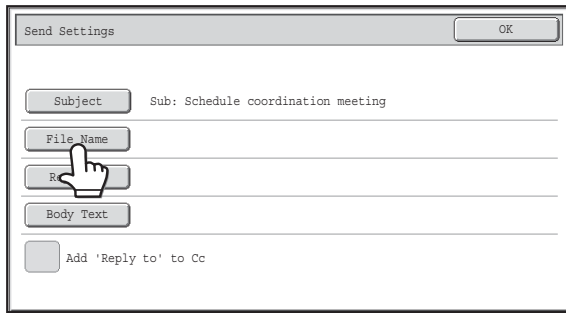

**To change the file name, touch the [File Name] key.**

- The file name is entered in the same way as the subject.
- If you are sending to a Scan to FTP, Scan to Desktop, or Scan to Network Folder destination, go to step 9.

5

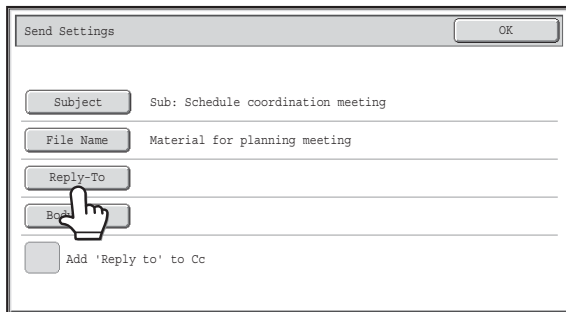

**To change "Reply-To", touch the [Reply-To] key.**



If user authentication is being used, the information of the user that logged in will be applied, and thus "Reply-To" cannot be changed.

6

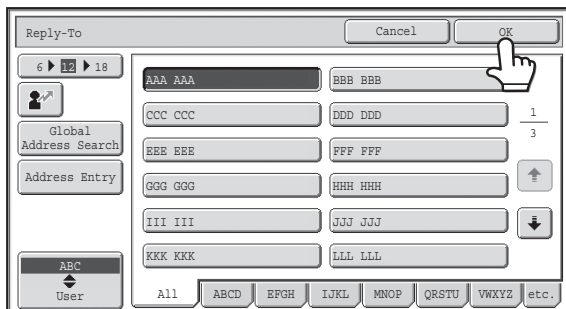

**Specify a user for "Reply-To" and touch the [OK] key.**

- Touch the key that you wish to use for "Reply-To".
- You can touch the [Global Address Search] key to specify a user stored in a global address book for "Reply-To". You can also touch the [Address Entry] key to directly enter an e-mail address.



- To specify the return address, you can touch the  key and enter a user number that has been previously stored using "User List" in the system settings (administrator).
- A key can only be selected for the return address if an e-mail address has been stored for that user in "User List" in the system settings (administrator).

7

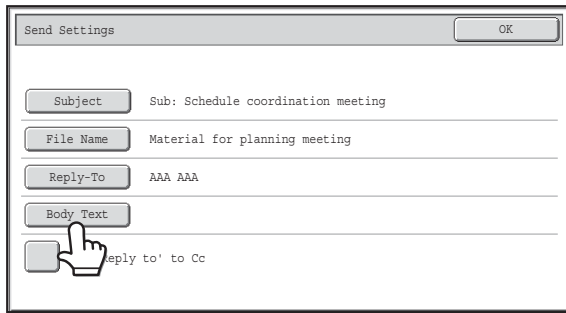

**To change the body text, touch the [Body Text] key.**

On the MX-2314N, when the productivity kit is not installed, Please go to step 9.

8

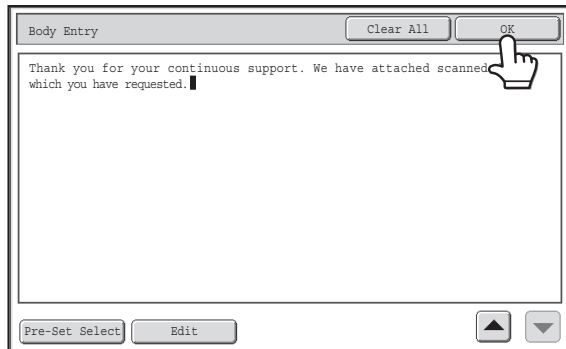

**Enter the body text and touch the [OK] key.**

- To select a pre-set text previously stored in the Web page, touch the [Pre-Set Select] key.
- To directly enter the body text, touch the [Edit] key.



- 1800 characters can be entered. (A line break counts as one character.)
- To clear all entered text, touch the [Clear All] key. When this key is touched, the entire body of the message is erased immediately; not just the selected line.
- Each line of the entered text can be selected with the keys. To edit the selected line, touch the [Edit] key. The text entry screen will appear with the selected text entered.

9

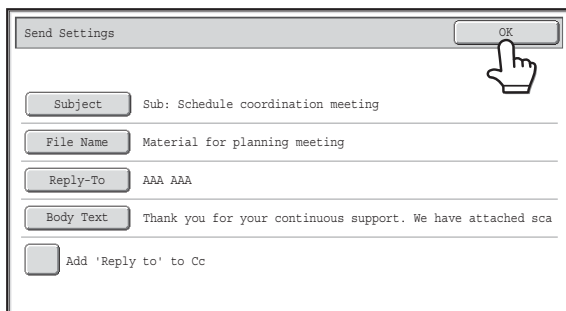

**Touch the [OK] key.**



- The [Add 'Reply to' to Cc] checkbox can be selected  to send a Cc copy to the sender.



When storing pre-set text for the subject and file name in the Web pages, up to 80 characters can be entered.



- **System Settings (Administrator): The Number of File Name/Subject/Body Keys Displayed Setting**  
The setting for the number of subject keys and file name keys displayed in one screen can be changed to 6, 12, or 18.
- **System Settings (Administrator): Default Sender Set**  
This is used to store the sender name and e-mail address that is used when a sender is not selected.

# SENDING AN IMAGE IN USB MEMORY MODE

Follow the steps below to send a scanned image to a commercially available USB memory device that has been connected to the machine. This stores the file in the USB device.

- Use a FAT32 USB memory with a capacity of no more than 32 GB.
- When a default address is configured in "Default Address Setting" in the system settings (administrator), the mode cannot be changed. To switch to USB memory mode, touch the [Cancel] key in the touch panel and then follow the steps below.

1

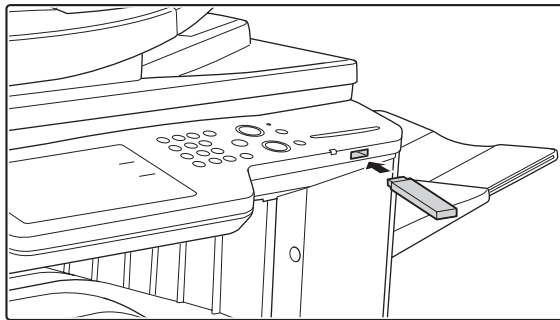

**Connect the USB memory to the USB connector (Type A) on the machine.**

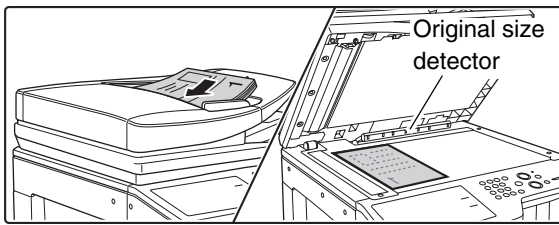





**Place the original.**

Do not place any objects under the original size detector. Closing the automatic document feeder with an object underneath may damage the original size detector plate and prevent correct detection of the document size.

2

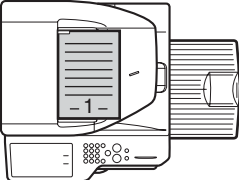
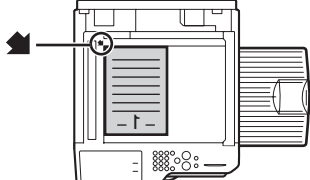
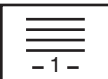
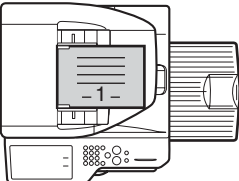
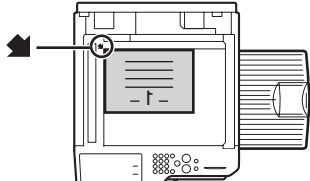
- When placing the originals, orient them as shown below.

Originals	Document feeder tray Place the original face up.	Document glass Place the original face down and align the corner with the tip of the arrow mark  in the top left corner of the document glass scale.
Portrait orientation* 		
Landscape orientation 		

- \* To place a large portrait-oriented original, place it as shown above in "Landscape orientation" and specify the placement orientation in step 4.
- Place A5 (5-1/2" x 8-1/2") size originals in portrait (vertical) orientation (). If placed in landscape (horizontal) orientation () , an incorrect size will be detected. For a A5R (5-1/2" x 8-1/2"R) size original, enter the original size manually.
- Originals cannot be scanned in succession from both the automatic document feeder and the document glass and sent in a single transmission.

3

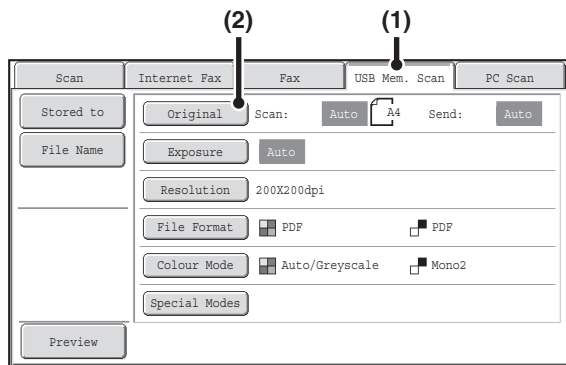

## Switch to USB memory mode and display the image settings screen.

### (1) Touch the [USB Mem. Scan] tab

If the [USB Mem. Scan] tab does not appear, touch the  tab to move the screen.

### (2) Touch the [Original] key.



- When scanning to USB memory, there is no need to specify the destination.
- If a destination of another mode has been previously specified, a message will appear when you change to USB memory mode indicating that the destination setting will be cleared. Touch the [OK] key in the message screen and go to the next step.
- The current settings for [Original], [Exposure], [Resolution], [File Format], and [Colour Mode] are indicated at the right of each key. To change a setting, touch the appropriate key.
  - ✎ [AUTOMATICALLY SCANNING BOTH SIDES OF AN ORIGINAL \(2-Sided Original\)](#) (page 5-54), [SPECIFYING THE ORIGINAL SCAN SIZE AND SEND SIZE \(Enlarge/Reduce\)](#) (page 5-55), [CHANGING THE EXPOSURE AND ORIGINAL IMAGE TYPE](#) (page 5-61), [CHANGING THE RESOLUTION](#) (page 5-63), [CHANGING THE FILE FORMAT](#) (page 5-64), [CHANGING THE COLOUR MODE](#) (page 5-68), [SPECIAL MODES](#) (page 5-71)

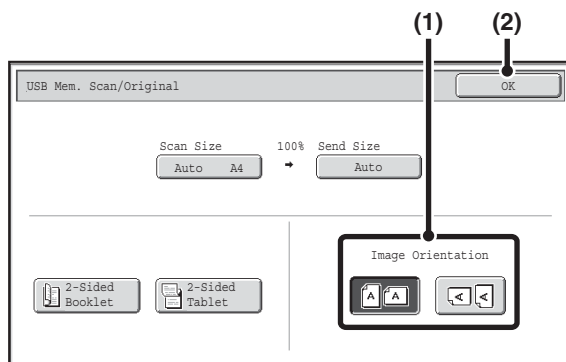

4



## Specify the orientation in which the original is placed.

To enable the original to be scanned in the correct orientation (the orientation in which the top edge of the original appears at the top of the display), specify the orientation in which the original was placed in step 2.

### (1) Touch the appropriate orientation key.

If the top edge of the original is up, touch the  key. If the top edge of the original is to the left, touch the  key.

### (2) Touch the [OK] key.

You will return to the screen of step 3.



- The original orientation is initially set to . If the original was placed with the top edge up, this step is not necessary.

## Press the [COLOUR START] key or the [BLACK & WHITE START] key.

Scanning begins.

- If the original is placed on the document glass, the [Read-End] key appears in the touch panel. If the original is only one page, go to step 7. To scan more pages, go to the next step.
- If the original was inserted in the document feeder tray, a beep will sound when scanning is completed and transmission will begin. Go to step 8.



Do not disconnect the USB memory until "Sending data has been completed." appears in the touch panel.



- To scan in full colour, press the [COLOUR START] key. To scan in black and white, press the [BLACK & WHITE START] key. If the colour mode of the [COLOUR START] key is set to [Auto], the colour of the original will be detected automatically and scanning in full colour, greyscale or Mono2 will take place.
- If Encrypt PDF is selected for the file format, you will be prompted to enter a password when you press the [START] key.

5

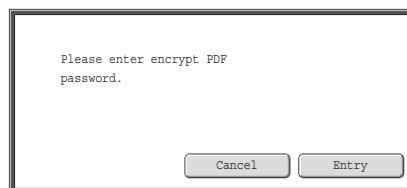

Touch the [Entry] key to open the keyboard screen, enter a password (maximum of 32 characters), and touch the [OK] key. The recipient must use the password entered here to open the Encrypt PDF file. To cancel Encrypt PDF, touch the [Cancel] key. The format settings screen will appear to let you change the file type. Select a new file type and press the [START] key to begin transmission.

6

## If the original was placed on the document glass, replace it with the next original and press the [COLOUR START] key or the [BLACK & WHITE START] key.

Repeat until all originals have been scanned.

7

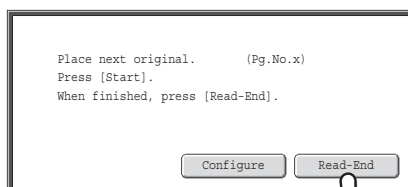

### Touch the [Read-End] key.

A beep will sound to indicate that the operation is completed. Open the automatic document feeder and remove the original.



- If no action is taken for one minute after the confirmation screen appears, scanning automatically ends and the transmission is reserved.
- The [Configure] key can be touched to change the exposure, resolution, scan size, and send size for each original page scanned. However, when "Card Shot" is selected in the special modes, only the exposure can be changed when scanning an even-numbered original page.



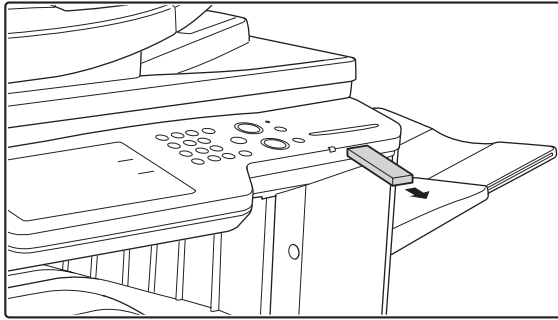

When "Sending data has been completed." appears in the touch panel, disconnect the USB memory.



Do not disconnect the USB memory while "Processing data." or "Sending data." appears in the touch panel.



- When transmission to USB memory is completed, "Sending data has been completed." is displayed. After a brief interval the message is cleared and the base screen of image send mode reappears. (The base screen of image send mode is the screen that appears when the [IMAGE SEND] key is touched.)
- **If the USB memory becomes full during scanning...**  
A message will appear and scanning will stop. The scanned data will not be stored. However, if the file format is set to JPEG and the [Specified Pages per File] checkbox is selected, files for which scanning is completed will be stored in USB memory.



- **To cancel scanning...**  
Press the [STOP] key (⏏) to cancel the operation.
- **To cancel scanning to USB memory...**  
While scanned data is being stored in the USB memory, the message "Sending data." and the [Cancel] key appear in the touch panel. To cancel the storing operation, touch the [Cancel] key.



- **System Settings: USB-Device Check (page 7-27)**  
This is used to check the connection of a USB device to the machine.
- **System Settings (Administrator): Scan Settings**  
This is used to set the default colour mode and file format.
- **System Settings (Administrator): Disable Scan Function**  
The use of PC scan mode and USB memory mode can be prohibited.

# SPECIFY THE FOLDER IN WHICH THE FILE WILL BE STORED

When sending a file to USB memory, a folder can be specified in USB memory. A new folder can also be created in USB memory.



If a folder is not specified, the file will be stored on the first level of the USB memory.

## 1

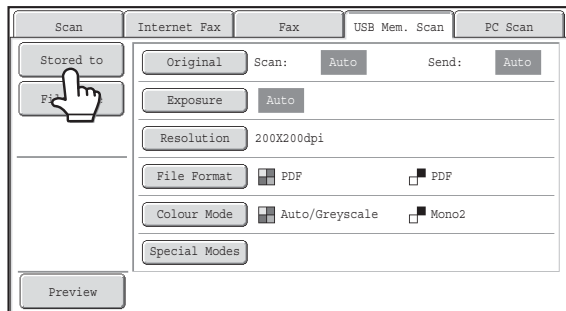

Touch the [Stored to] key.

## 2

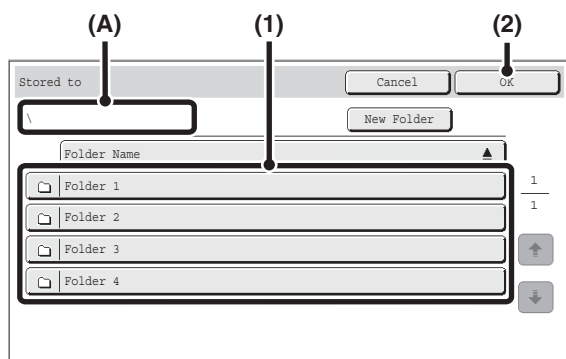

Select the folder.

**(1) Touch the key of the folder in which you wish to store the file.**

If the selected folder contains another folder, you can select that folder. The current folder level appears in (A).

**(2) Touch the [OK] key.**

You will return to the base screen. The [Stored to] key will be highlighted.



- To create a new folder on the currently displayed level, touch the [New Folder] key. A text entry screen will appear. Enter a folder name and touch the [OK] key. For the procedure for entering text, see "ENTERING TEXT" (page 1-70) in "1. BEFORE USING THE MACHINE".
- To move up one level, touch the key. This key appears when a folder on the second level or lower is selected.
- To change the order of the keys that appear in a screen, touch the key that shows or . Each time the key is touched, the order changes between ascending and descending.



Specify a folder name and file name that are within the allowed number of display characters of your operating system. If the file name or folder name exceeds the allowed number of characters, it may not be possible to display the scanned file.

# ENTERING A FILE NAME

The file name can be directly entered when performing a scan transmission.



- If the file name is not entered, the settings in the Web page are used.
- For the procedure for entering text, see "[ENTERING TEXT](#)" (page 1-70) in "1. BEFORE USING THE MACHINE".

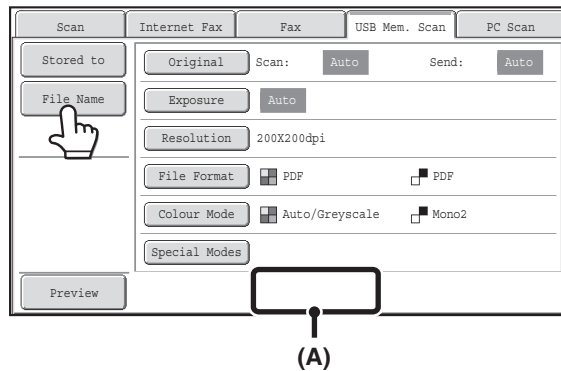

Touch the [File Name] key. A text entry screen will appear. Enter the file name and touch the [OK] key. Enter the file name and touch the [OK] key. The entered file name will appear in (A).

# SENDING A FAX IN INTERNET FAX MODE

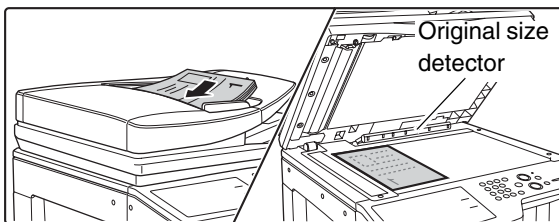

The basic procedure for sending a fax in Internet fax mode is explained below. This procedure can also be used to perform direct transmission by Direct SMTP.

- When a default address is configured in "Default Address Setting" in the system settings (administrator), the mode cannot be changed, the destination cannot be changed, and destinations cannot be added. To switch to Internet fax mode, touch the [Cancel] key in the touch panel and follow the steps below.  
When "Default Address Setting" is set to "Apply E-mail address of the user for login.", pressing the [Add Address] key on the touch panel switches to Internet fax mode.
- If the [Apply also for Fax/I-Fax Screen] checkbox is set to , the [Add Address] key does not appear when destinations are added in fax or Internet fax mode screen, and then the mode is switched to scanner/image send mode. Destinations can be added using the [Address Book] key, [Address Entry] key, or the  key.



## Place the original.

- Place the original face up in the document feeder tray, or face down on the document glass.
- Do not place any objects under the original size detector. Closing the automatic document feeder with an object underneath may damage the original size detector plate and prevent correct detection of the document size.

- Place A5 (5-1/2" x 8-1/2") size originals in portrait (vertical) orientation (). If placed in landscape (horizontal) orientation () , an incorrect size will be detected. For an A5R (5-1/2" x 8-1/2"R) size original, enter the original size manually.
- **Image rotation**  
A4, B5R, and A5R (8-1/2" x 11" and 5-1/2" x 8-1/2"R) originals are rotated 90 degrees and transmitted in A4R, B5, or A5 (8-1/2" x 11"R or 5-1/2" x 8-1/2") orientation. (A4R, B5, and A5 (8-1/2" x 11"R and 5-1/2" x 8-1/2") originals cannot be rotated for transmission.)

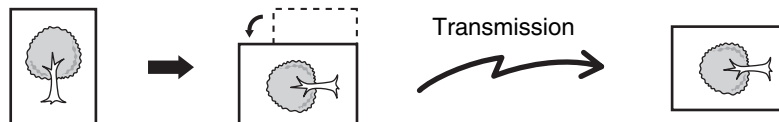

- Originals cannot be scanned in succession from both the automatic document feeder and the document glass and sent in a single transmission.

## System Settings (Administrator): Rotation Sending Setting

This is used to select whether or not a scanned original image is rotated before transmission.

The default setting is: rotate A4 to A4R, B5R to B5, and A5R to A5 (8-1/2" x 11" to 8-1/2" x 11"R, and 5-1/2" x 8-1/2"R to 5-1/2" x 8-1/2").

2

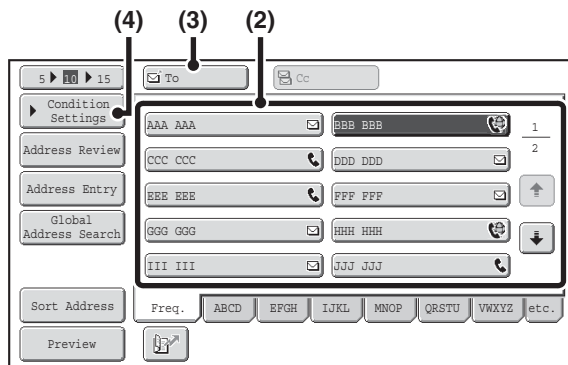

**Specify the destination.**

(1) Touch the [Address Book] key in the base screen.

(2) Touch the key of the desired destination.

The  icon appears in one-touch keys in which Internet fax addresses are stored.

(3) Touch the [To] key.

The destination is specified.

(4) Touch the [Condition Settings] key.



- After a one-touch key is touched, if the screen is changed without touching the [To] key, the destination is automatically specified.
- In addition to specification by a one-touch key, a destination can also be specified by a search number. You can also manually enter a destination or look up a destination in a global address book. For more information, see "ENTERING DESTINATIONS" (page 5-18).

3

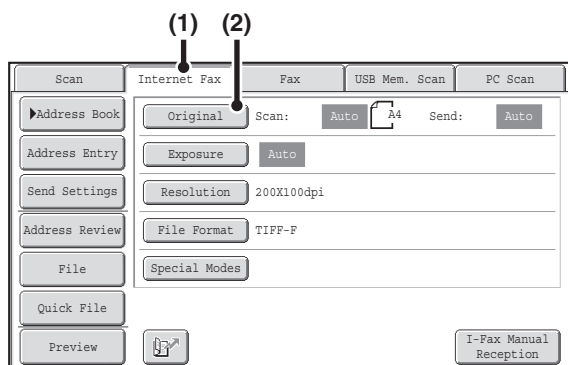

**Switch to Internet fax mode and display the image settings screen.**

(1) Touch the [Internet Fax] tab.

(2) Touch the [Original] key.



The current settings for [Original], [Exposure], [Resolution], and [File Format] are indicated at the right of each key. To change a setting, touch the appropriate key.

- [AUTOMATICALLY SCANNING BOTH SIDES OF AN ORIGINAL \(2-Sided Original\)](#) (page 5-54), [SPECIFYING THE ORIGINAL SCAN SIZE AND SEND SIZE \(Enlarge/Reduce\)](#) (page 5-55), [CHANGING THE EXPOSURE AND ORIGINAL IMAGE TYPE](#) (page 5-61), [CHANGING THE RESOLUTION](#) (page 5-63), [CHANGING THE FILE FORMAT](#) (page 5-64), [SPECIAL MODES](#) (page 5-71)

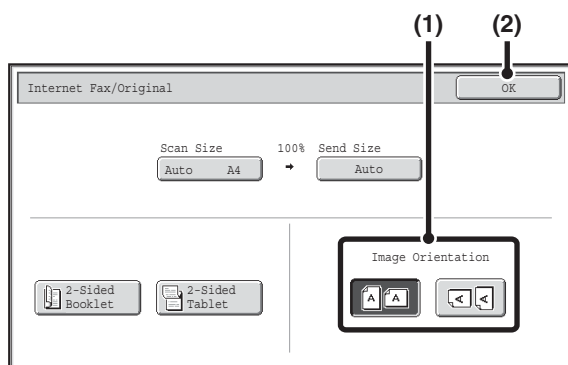

4



**Specify the orientation in which the original is placed.**

When specifying the orientation of the image to be transmitted, specify the orientation of the original placed in step 1.

(1) Touch the appropriate orientation key.

If the top edge of the original is up, touch the  key. If the top edge of the original is to the left, touch the  key.

(2) Touch the [OK] key.

You will return to the screen of step 2.



The original orientation is initially set to . If the original was placed with the top edge up, this step is not necessary.

## 5 Press the [BLACK & WHITE START] key.

Scanning begins.

- If the original is placed on the document glass, the [Read-End] key appears in the touch panel. If the original is only one page, go to step 7. To scan more pages, go to the next step.
- If the original was inserted in the document feeder tray, a beep will sound when scanning is completed and transmission will take place.

## 6

## If the original was placed on the document glass, replace it with the next original and press the [BLACK & WHITE START] key.

Repeat until all originals have been scanned.

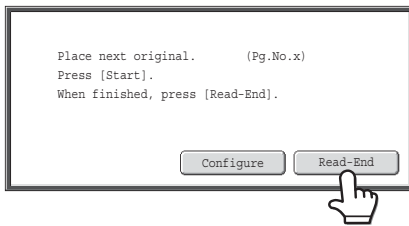

## Touch the [Read-End] key.

A beep will sound to indicate that the operation is completed. Open the automatic document feeder and remove the original.

## 7



- If no action is taken for one minute after the confirmation screen appears, scanning automatically ends and the transmission is reserved.
- The [Configure] key can be touched to change the exposure, resolution, scan size, and send size for each original page scanned. However, when "2in1" or "Card Shot" is selected in the special modes, only the exposure can be changed when scanning an even-numbered original page.



- When all originals have been scanned, "Job stored." will be displayed together with a job control number. This number can be used to locate the job in the Transaction Report or in the Image Sending Activity Report. If the job is a broadcast transmission, this number will also appear in the key of the job in the job status screen. For this reason, making a note of the number is useful for checking the result.
- If the memory becomes full while the originals are being scanned, a message will appear and scanning will stop.
- **Storing a mail signature**  
You can have preset text automatically added at the end of e-mail messages as a mail signature. This is convenient when you wish to have a corporate policy or other preset text appear at the bottom of e-mail messages. To store the text for the mail signature, click [Application Settings], [Network Scanner Settings] and then [Administration Settings] in the Web page menu. (Administrator rights are required.) Up to 900 characters can be entered. (The mail signature is not included in the maximum number of characters that can be entered in the e-mail message.)  
Use "Pre-Setting Mail Signature" in the system settings (administrator) to specify whether or not a mail signature is added.



### To cancel scanning...

Press the [STOP] key (⏏) to cancel the operation.



### • System Settings (Administrator): I-Fax Send Settings

This is used to select Internet fax transmission settings such as the receive report setting, rotation setting, size restriction setting, and sender information attachment setting.

### • System Settings (Administrator): Pre-Setting Mail Signature

Use this setting to specify whether or not a mail signature is added at the end of e-mail messages. By factory default, a mail signature is not added.

# CHANGING THE SUBJECT, FILE NAME, AND BODY TEXT

The subject, file name, and body text can be changed when performing an Internet fax transmission. Preset items can be selected or text can be directly entered.

- If the subject and file name are not changed, the settings in the Web page are used.
- Selections for the subject, file name, and body text are configured by clicking [Application Settings] and then [Network Scanner Settings] in the Web page menu.
- For the procedure for entering text, see "[ENTERING TEXT](#)" (page 1-70) in "1. BEFORE USING THE MACHINE".

## 1 Touch the [Send Settings] key in the base screen.

 [BASE SCREEN](#) (page 5-9)

## 2

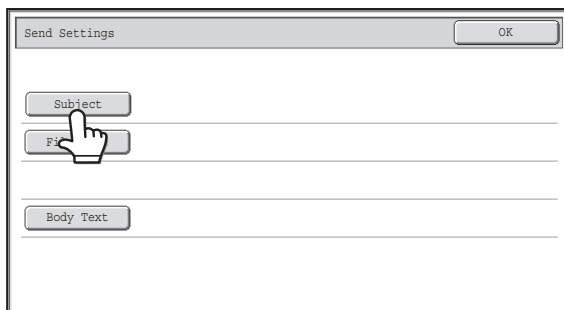

To change the subject, touch the [Subject] key.

## 3

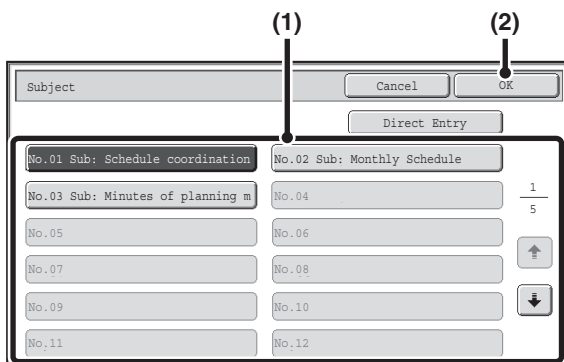

Enter the subject.

- (1) Touch a pre-set text key.
- (2) Touch the [OK] key.

- If you wish to directly enter the text, touch the [Direct Entry] key to open the text entry screen. Enter the text and touch the [OK] key.
- The text in a pre-set text key can be edited by touching the pre-set text key and then the [Direct Entry] key. The text entry screen will appear with the selected pre-set text entered. (When a destination is stored using the Web page, up to 80 characters can be entered. However, only 54 characters can be entered in the touch panel.)

4

Send Settings OK

Subject Sub: Schedule coordination meeting

File Name

Body Text

**To change the file name, touch the [File Name] key.**

The file name is entered in the same way as the subject.

5

Send Settings OK

Subject Sub: Schedule coordination meeting

File Name Material for planning meeting

Body Text

**To change the body text, touch the [Body Text] key.**

6

Body Entry Clear All OK

Thank you for your continuous support. We have attached scanned which you have requested. █

Pre-Set Select Edit ▲ ▼

**Enter the body text and touch the [OK] key.**

- To select a pre-set message previously stored in the Web page, touch the [Pre-Set Select] key.
- To directly enter the message, touch the [Edit] key.



- 1800 characters can be entered. (A line break counts as one character.)
- To clear all entered text, touch the [Clear All] key. When this key is touched, the entire body of the message is erased immediately; not just the selected line.
- Each line of the entered text can be selected with the ▼ ▲ keys. To edit the selected line, touch the [Edit] key. The text entry screen will appear with the selected text entered.



7

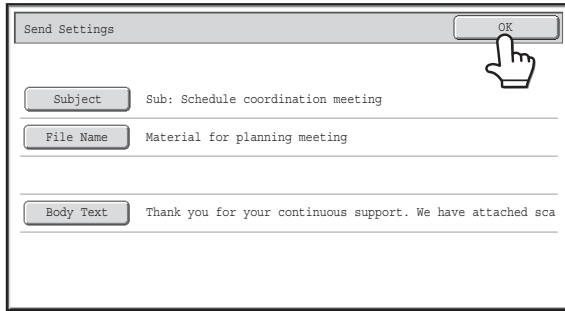

Send Settings

OK

Subject Sub: Schedule coordination meeting

File Name Material for planning meeting

Body Text Thank you for your continuous support. We have attached sca

Touch the [OK] key.



When storing pre-set text for the subject and file name in the Web pages, up to 80 characters can be entered.



**System Settings (Administrator): The Number of File Name/Subject/Body Keys Displayed Setting**

The setting for the number of subject keys and file name keys displayed in one screen can be changed to 6, 12, or 18.

# SENDING THE SAME IMAGE TO MULTIPLE DESTINATIONS (Broadcast Transmission)

The same scanned image can be sent to multiple scan modes, Internet fax mode, and fax mode destinations in a single operation. Up to 500 destinations can be selected in one broadcast operation.

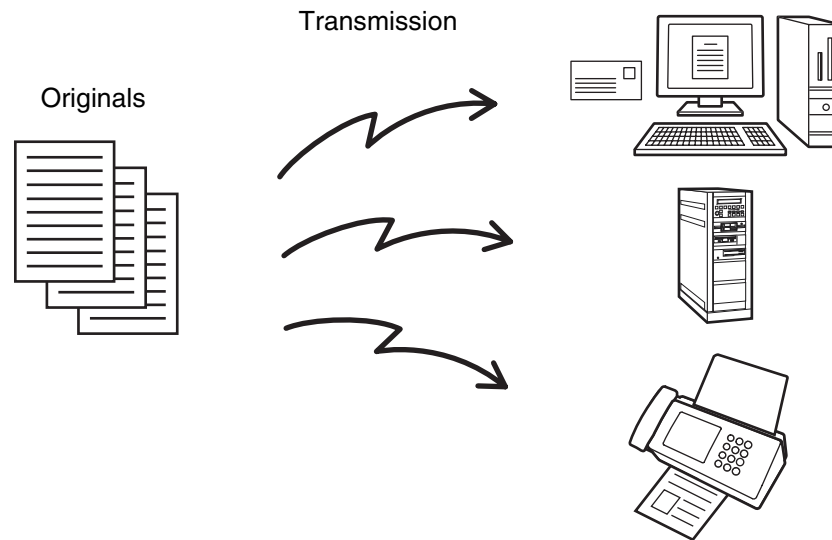

If you frequently use broadcasting to send images to the same group of destinations, it is convenient to store those destinations in a group key.

1

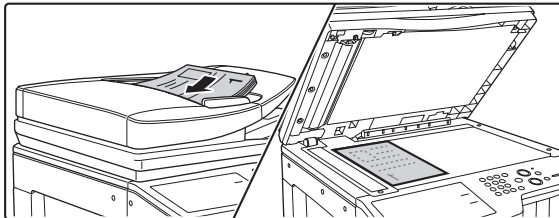

## Place the original.

Place the original face up in the document feeder tray, or face down on the document glass.

2

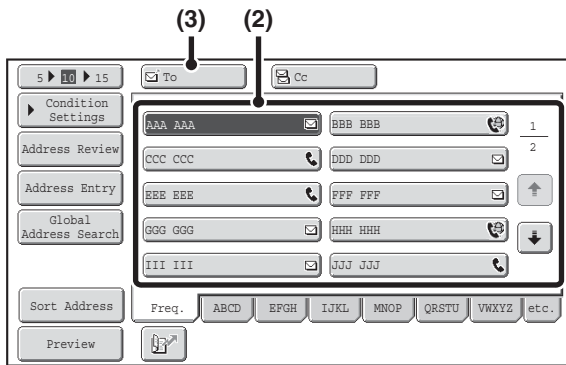

**Specify the destination.**

- (1) Touch the [Address Book] key in the base screen.
- (2) Touch the one-touch key of the desired destination.
- (3) Touch the [To] key.  
The destination is specified.
- (4) Repeat steps (2) and (3) until all destinations are selected.



- To add Cc or Bcc recipients, select a recipient and touch the [Cc] key or the [Bcc] key.
- If "Must Input Next Address Key at Broadcast Setting" is enabled in the system settings (administrator), touch the [Next Address] key before specifying the next destination.
- One-touch keys that cannot be used for broadcast transmission are greyed out to prevent selection.
- If a Scan to FTP (Hyperlink) address is specified in a broadcast transmission, hyperlink e-mail transmission will not take place.
- If you frequently use broadcasting to send images to the same group of destinations, it is convenient to store those destinations in a group key.

3

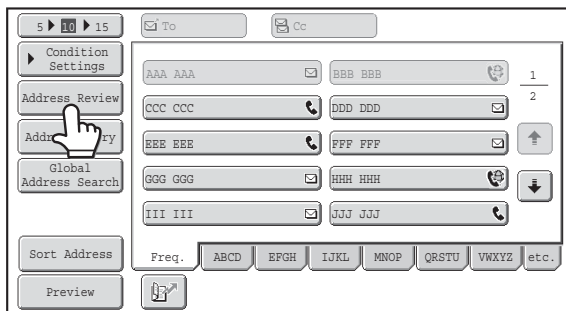

**Touch the [Address Review] key.**

4

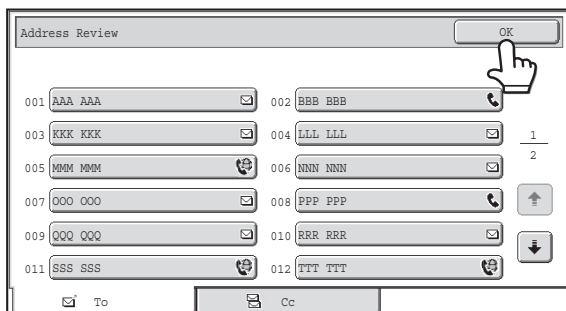

**Check the destinations and then touch the [OK] key.**



If the transmission includes Cc or Bcc destinations, touch the [Cc] tab or the [Bcc] tab to check those destinations.



**To cancel a specified destination...**

Touch the one-touch key of the destination that you wish to cancel. A message will appear to confirm the deletion. Touch the [Yes] key.

[CHECKING AND DELETING THE SELECTED DESTINATIONS](#) (page 5-20)

**Press the [COLOUR START] key or the [BLACK & WHITE START] key.**

Scanning begins.

- If you inserted the original pages in the document feeder tray, all pages are scanned.  
A beep will sound to indicate that scanning is finished.
- If you are scanning the original on the document glass, scan each page one page at a time.  
When scanning of one page finishes, replace it with the next page and press the [COLOUR START] key or the [BLACK & WHITE START] key. Repeat until all pages have been scanned and then touch the [Read-End] key.  
A beep will sound to indicate that scanning is finished.



If Internet fax or fax destinations are included in the broadcast transmission, the [COLOUR START] key cannot be pressed. Scanning will take place in Mono2.

**To cancel scanning...**

Press the [STOP] key (⏏) to cancel the operation.

# BROADCAST TRANSMISSIONS THAT INCLUDE INTERNET FAX DESTINATIONS

When a broadcast transmission includes both scan mode and Internet Fax mode destinations, the Internet Fax mode settings (original orientation and other various settings) are given priority. When performing this type of broadcast transmission, note the information below.

<b>Original placement orientation</b>	The orientation of Internet fax mode is given priority. When "Rotation Sending Setting" is enabled in the system settings (administrator), the image is rotated 90 degrees. For this reason, in some cases the image may not be displayed in the correct orientation.
<b>Send size</b>	When the file format is set to [TIFF-S] in Internet fax mode, transmission is only possible in A4R (8-1/2" x 11"R) size.
<b>Exposure</b>	The Internet fax settings are given priority.
<b>Resolution</b>	When the file format is set to [TIFF-S] in Internet fax mode and a high resolution setting is selected in scan mode, the resolution will be changed to [200X200dpi].
<b>File compression mode</b>	The compression mode will be changed to the compression mode set in "Compression Mode at Broadcasting" in the system settings (administrator).
<b>Colour scanning</b>	Scanning will take place in Mono2 regardless of the colour mode setting.
<b>Special modes</b>	<b>2in1</b>
This cannot be selected in scan mode, however, if selected in Internet fax mode, it will also be applied to scan destinations.	
<b>Scan file size</b>	If a broadcast transmission is performed that includes destinations for which an attachment size limit has been set using "Maximum Size of E-mail Attachments (E-mail)" or "Maximum Size of Data Attachments (FTP/Desktop/Network Folder)" in the system settings (administrator), the limit will also apply to destinations for which a limit is not set. (The limitation setting of Scan to E-mail or Internet fax is given priority.)

## Resending to unsuccessful broadcast transmission destinations

The results of a completed broadcast transmission can be checked in the job status screen. If transmission to any of the addresses failed, resend the image to those addresses.

1

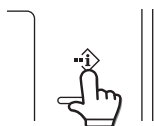

Touch the [JOB STATUS] key (i).

2

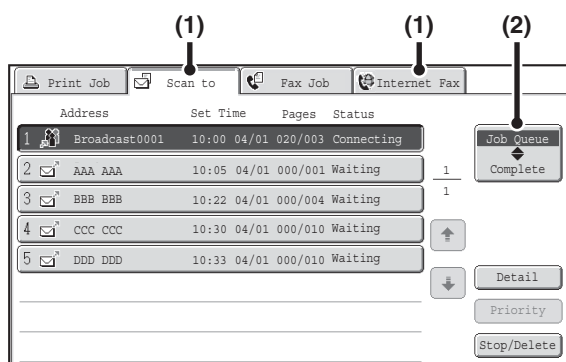

Display the jobs completed screen.

- (1) Touch the tab of the mode that you wish to display.
- (2) Touch the [Complete] key.



If the broadcast transmission included destinations of different modes, the same broadcast transmission key will appear in each of those modes.

3

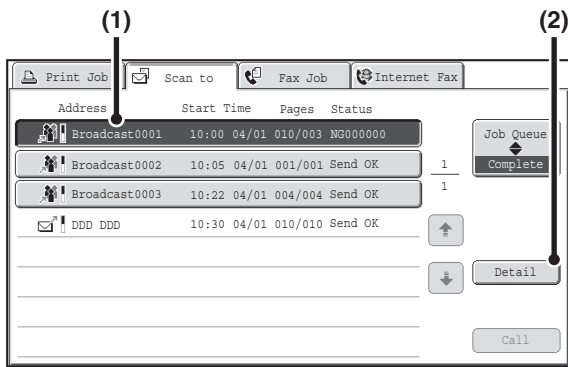

**Display details on the broadcast transmission.**

- (1) Touch the key of the completed broadcast transmission.
- (2) Touch the [Detail] key.



"Broadcastxxxx" will appear as the address of the broadcast job key. The job control number that appeared in the touch panel when scanning ended appears in "xxxx".

4

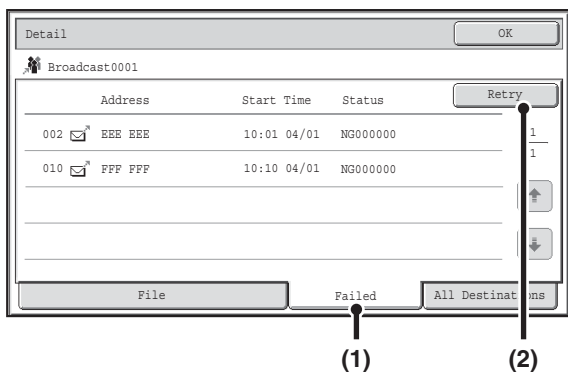

**Resend the image to the unsuccessful destinations.**

- (1) Touch the [Failed] tab.
- (2) Touch the [Retry] key.



- The steps to follow after the [Retry] key is touched differ depending on whether or not the document filing function is used.

**Not using document filing**

You will return to the base screen with the unsuccessful destinations entered. Place the original and perform the steps of the broadcast transmission.

**Using document filing**

You will return to the document filing resend screen with the unsuccessful destinations entered. Perform the document filing resend procedure. (There is no need to rescan the original.)

- If the [All Destinations] tab is touched in (1), all destinations will be displayed. The [Retry] key that appears in the screen can be touched to resend to all the destinations.

---

---

# SENDING AN INTERNET FAX FROM A COMPUTER (PC-I-Fax)

A file on a computer can be sent via the machine as an Internet fax (PC-I-Fax function). Internet faxes are sent using the PC-I-Fax function in the same way as documents are printed. Select the PC-Fax driver as the printer driver for your computer and then select the Print command in the software application. Image data for transmission will be created and sent as an Internet fax.

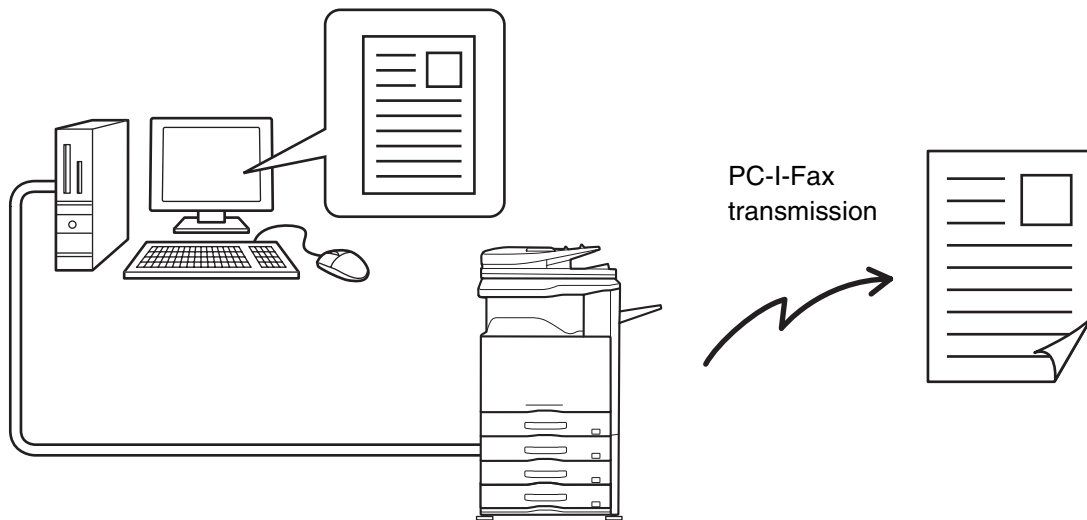

For the procedures for using this function, see the PC-Fax driver Help.



- To send an Internet fax using the PC-I-Fax function, the PC-Fax driver must be installed and then updated using the CD-ROM that accompanies the Internet fax expansion kit. For more information, see the Software Setup Guide.
- This function can only be used on a Windows computer.
- This function can only be used for transmission. Internet faxes received on the machine cannot be received to a computer that is connected to the machine.

# IMAGE SETTINGS

Settings for scanning the original are selected in the base screen of each mode. The current state of each setting appears to the right of the key used to select the setting.

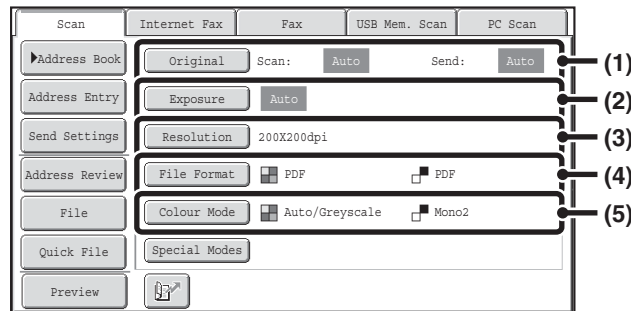

## (1) [Original] key

Touch this key to set the scan size, send size, and orientation of the original, and select 2-sided scanning settings.

➤ [AUTOMATICALLY SCANNING BOTH SIDES OF AN ORIGINAL \(2-Sided Original\)](#) (page 5-54),  
 ➤ [SPECIFYING THE ORIGINAL SCAN SIZE AND SEND SIZE \(Enlarge/Reduce\)](#) (page 5-55)

## (2) [Exposure] key

Touch this key to select the exposure for scanning.

➤ [CHANGING THE EXPOSURE AND ORIGINAL IMAGE TYPE](#) (page 5-61)

## (3) [Resolution] key

Touch this key to select the resolution for scanning.

➤ [CHANGING THE RESOLUTION](#) (page 5-63)

## (4) [File Format] key

Touch this key to change the format (file type) of the scanned image file.

➤ [CHANGING THE FILE FORMAT](#) (page 5-64)

## (5) [Colour Mode] key

Touch this key to select the colour mode for scanning. This key does not appear in Internet fax mode.

➤ [CHANGING THE COLOUR MODE](#) (page 5-68)



# AUTOMATICALLY SCANNING BOTH SIDES OF AN ORIGINAL (2-Sided Original)

The automatic document feeder can be used to automatically scan both sides of an original.

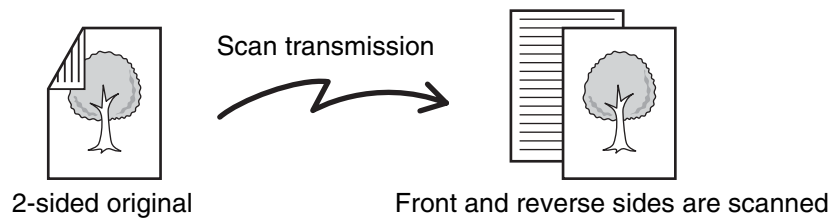

1

## Select the mode and display the image settings screen.

- (1) Touch the tab of the mode that you wish to use.
  - (2) Touch the [Original] key.
- ☞ [IMAGE SETTINGS](#) (page 5-53)

2

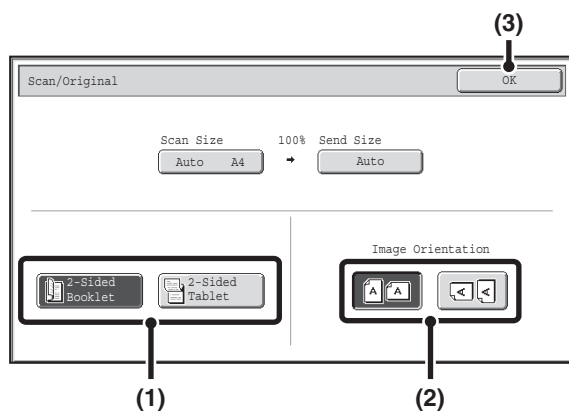

## Specify the binding style of the 2-sided original (book or tablet) and the orientation in which the original is placed.

- (1) Touch the [2-Sided Booklet] key or the [2-Sided Tablet] key.

A book and a tablet are bound as shown below.

Book



Tablet



- (2) Touch the appropriate [Image Orientation] key.

If this setting is not correct, a suitable image may not be transmitted.

- (3) Touch the [OK] key.



To cancel 2-sided scanning, touch the highlighted key so that it is no longer highlighted.



2-sided scanning automatically turns off after the transmission operation is completed.

## SPECIFYING THE ORIGINAL SCAN SIZE AND SEND SIZE (Enlarge/Reduce)

When the original is placed, its size is automatically detected and displayed in the base screen.

The size of the placed original is indicated as the scan size, and the size to be transmitted is indicated as the send size.

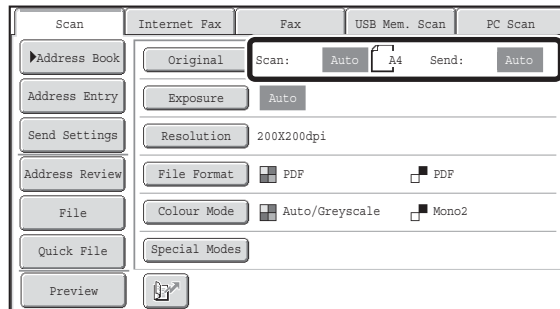

In the above screen, the scan size (the placed original) is A4 (8-1/2" x 11") and the send size is auto. For example, if the scan size is A4 (8-1/2" x 11") and the send size is B5 (5-1/2" x 8-1/2"), the image will be reduced before transmission.

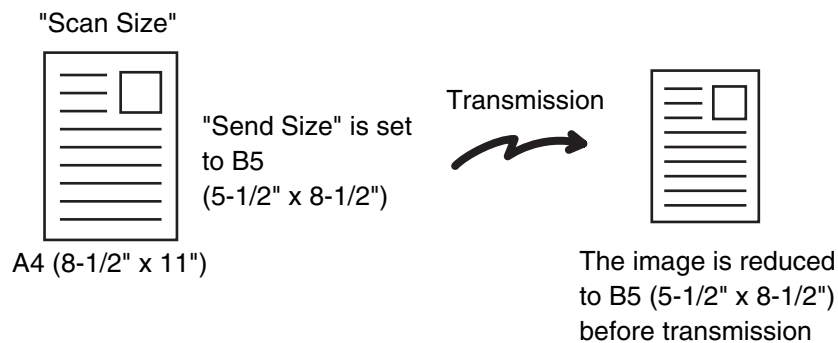

- Only standard original sizes can be automatically detected.  
[STANDARD SIZES](#) (page 5-17)
- When the original size is a non-standard size, or if the size is not detected correctly, manually specify the original scan size.  
[Specifying the original scan size \(by paper size\)](#) (page 5-56)  
[Specifying the original scan size \(by numerical values\)](#) (page 5-57)

## Specifying the original scan size (by paper size)

If the original is a non-standard size or you wish to change the scan size, touch the [Original] key to specify the original size manually. Place the original in the document feeder tray or on the document glass and follow the steps below.

### Select the mode and display the image settings screen.

1

- (1) Touch the tab of the mode that you wish to use.
- (2) Touch the [Original] key.

The automatically detected original size appears to the right of the [Original] key.

🔗 [IMAGE SETTINGS](#) (page 5-53)

2

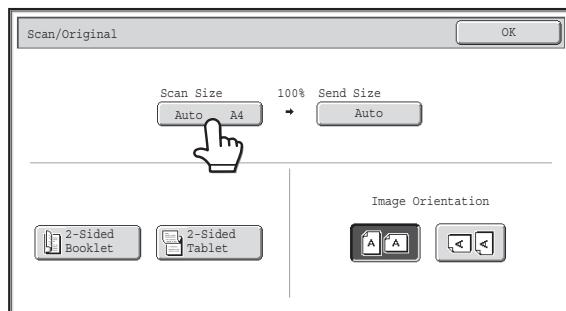

### Touch the [Scan Size] key.

3

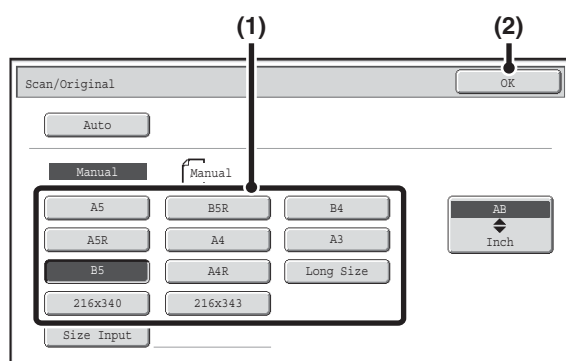

### Specify the scan size.

- (1) Touch the appropriate original size key.
- (2) Touch the [OK] key.



- If you are sending a long original, touch the [Long Size] key. Use the automatic document feeder to scan a long original. The maximum width that can be scanned is 1000 mm (39-3/8") (the maximum height is 297 mm (11-5/8")).  
🔗 [TRANSMITTABLE ORIGINAL SIZES](#) (page 5-17)
- To specify an Inch size for the scan size, touch the [AB  $\blacklozenge$  Inch] key to highlight the [Inch] side and then specify the scan size.

4

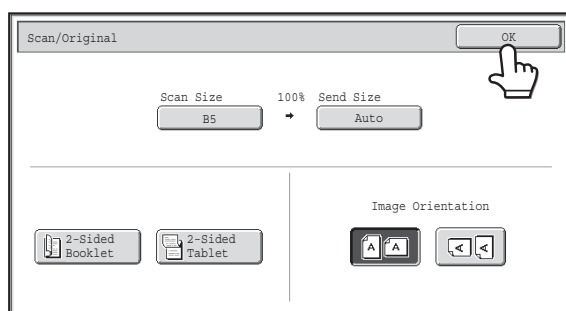

### Touch the [OK] key.



When [Long Size] is selected, the 2-sided scanning setting and send size cannot be changed. In addition, when only scan destinations are selected for scan transmission or metadata transmission, scanning will take place in Mono2.

## Specifying the original scan size (by numerical values)

When scanning a non-standard size original such as a card, follow these steps to specify the original size. The width can be from 25 mm to 432 mm (1" to 17"), and the height can be from 25 mm to 297 mm (1" to 11-5/8").

### Select the mode and display the image settings screen.

1

- (1) Touch the tab of the mode that you wish to use.
- (2) Touch the [Original] key.

The automatically detected original size appears to the right of the [Original] key.

🔗 [IMAGE SETTINGS](#) (page 5-53)

2

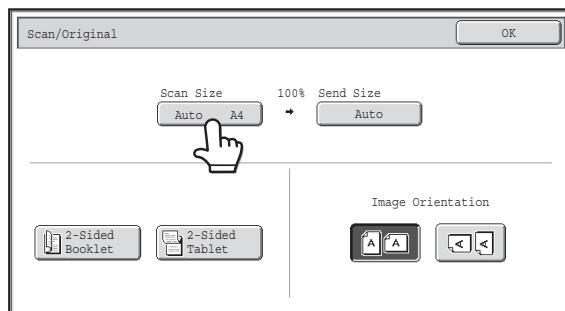

Touch the [Scan Size] key.

3

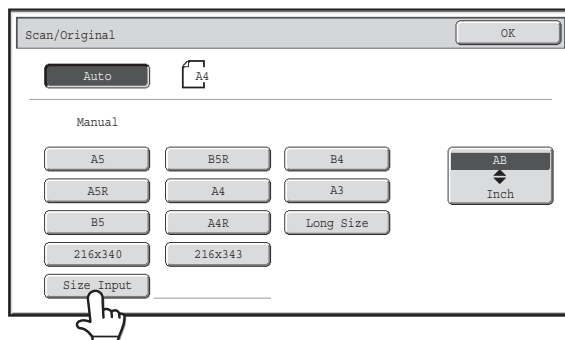

Touch the [Size Input] key.

4

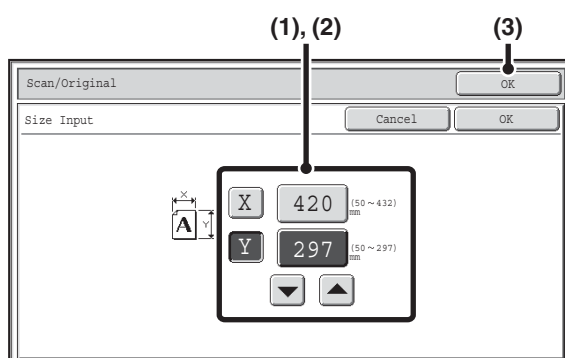

Enter the scan size (original size).

- (1) Touch the X (width) numeric value display key and enter the width.
- (2) Touch the Y (height) numeric value display key and enter the height.
- (3) Touch the [OK] key.

Touch the [OK] key next to the [Cancel] key to complete the setting and return to the screen of step 3.



You can also touch the keys to change the number.

5

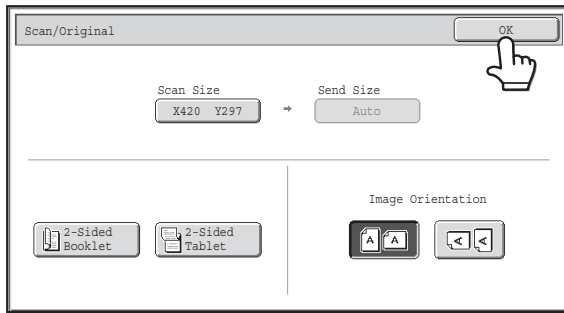

### Touch the [OK] key.

The specified size appears in the [Scan Size] key.



- When the scan size is specified by numerical values, the send size cannot be specified.
- When the automatic document feeder is used, an original longer than 432 mm (17") can be scanned (maximum width 1000 mm (39-3/8")). In this case, touch the [Long Size] key in the screen of step 3.
  - [Specifying the original scan size \(by paper size\)](#) (page 5-56)
  - [TRANSMITTABLE ORIGINAL SIZES](#) (page 5-17)

## Specifying the send size of the image

Specify the send size as a paper size. If a send size bigger than the scan size is selected, the image will be enlarged. If a send size smaller than the scan size is selected, the image will be reduced.



- The send size cannot be specified when [Long Size] is selected for the scan size, or when the scan size is specified by numerical values.
- The send size cannot be specified when [TIFF-S] is selected for the format in Internet fax mode. (The send size is fixed at A4R (8-1/2" x 11"R).)

1

### Select the mode and display the image settings screen.

- (1) Touch the tab of the mode that you wish to use.
- (2) Touch the [Original] key.

🔗 [IMAGE SETTINGS](#) (page 5-53)

2

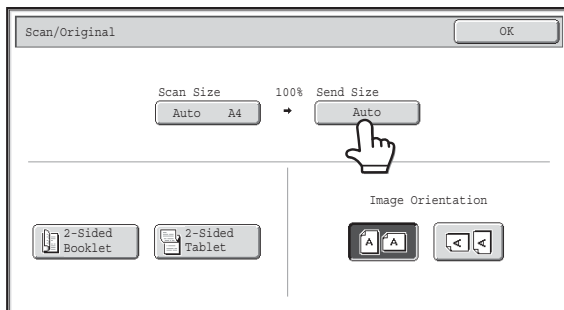

Touch the [Send Size] key.

3

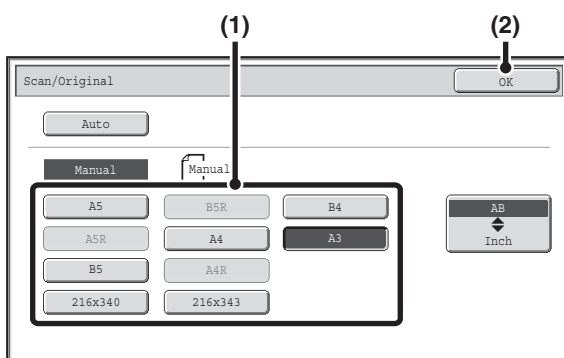

Specify the send size.

- (1) Touch the desired send size key.
- (2) Touch the [OK] key.



- Depending on the paper size specified for the "Scan Size", it may not be possible to select some sizes for the "Send Size". Size keys that cannot be specified for the "Send Size" are greyed out to prevent selection.
- To specify an Inch size for the send size, touch the [AB ⬆️ Inch] key to highlight the [Inch] side and then specify the send size.

4

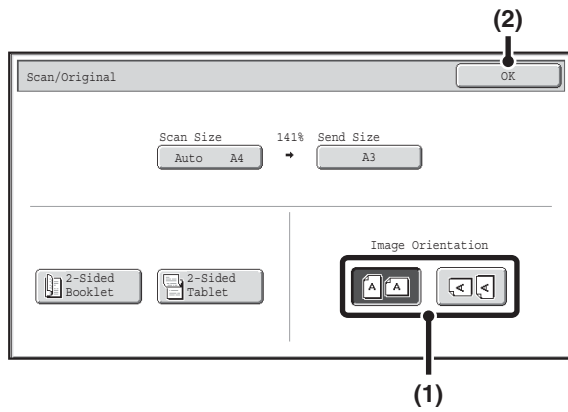

**Specify the orientation in which the original is placed.**

**(1) Touch the appropriate [Image Orientation] key.**

If this setting is not correct when sending an image with a changed ratio, a suitable image may not be transmitted.

**(2) Touch the [OK] key.**



The ratio used for reduction or enlargement of the original will appear between the "Scan Size" and the "Send Size".

# CHANGING THE EXPOSURE AND ORIGINAL IMAGE TYPE

The exposure and original image type can be set appropriately for the original to enable optimum scanning. Refer the following tables to select appropriate settings.

## How to select the exposure

Exposure		When to select
Auto		This setting automatically adjusts the exposure for light and dark parts of the original.
Manual	1-2	Select this setting when the original consists of dark text.
	3	Select this setting for a normal original (neither dark nor light).
	4-5	Select this setting when the original consists of faint text.

## How to select the original image type (Scan mode, USB memory mode and Data entry mode)

Setting		Description
Auto		The original image type is automatically selected to match the original.
Manual	Text/Prt. Photo	This mode provides the best balance for scanning an original which contains both text and printed photographs, such as a magazine or catalogue.
	Text/Photo	This mode provides the best balance for scanning an original which contains both text and photographs, such as a text document with a photo pasted on.
	Text	Use this mode for regular text documents.
	Photo	Use this mode to scan photos.
	Printed Photo	This mode is best for scanning printed photographs, such as photos in a magazine or catalogue.
	Map	This mode is best for scanning the colour shading and fine details found on most maps.

### 1 Select the mode and display the exposure settings screen.

- (1) Touch the tab of the mode that you wish to use.
- (2) Touch the [Exposure] key.

 [IMAGE SETTINGS](#) (page 5-53)

### 2

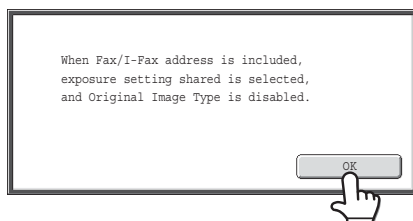

### Read the displayed message and touch the [OK] key.

This message does not appear in USB memory mode or Internet fax mode. Go to the next step.







If a broadcast transmission is performed that includes both scan mode destinations and Internet fax destinations, the exposure settings for Internet fax mode will have priority.

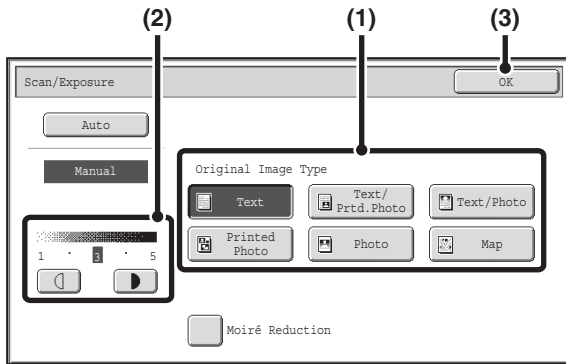

Scan mode, USB memory mode, Data entry mode







Select the exposure and original image type.

- (1) **Select the original image type.**  
Touch the original image type key that matches the original image type.
- (2) **Adjust the exposure with the   keys.**  
The exposure darkens when the  key is touched, and lightens when the  key is touched.
- (3) **Touch the [OK] key.**

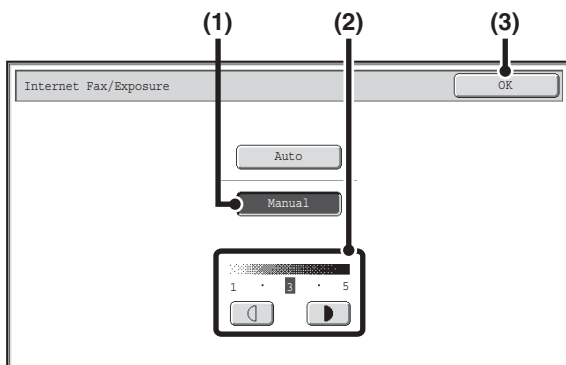
3

Internet fax mode



- (1) **Touch the [Manual] key.**
- (2) **Adjust the exposure with the   keys.**  
The exposure darkens when the  key is touched, and lightens when the  key is touched.
- (3) **Touch the [OK] key.**

-  In Internet fax mode, the original image type and moiré reduction cannot be selected.
- To reduce the occurrence of line patterns (moiré effect) when scanning printed matter, touch the [Moiré Reduction] checkbox so that a checkmark  appears.

 When using the document glass to scan multiple original pages, the exposure setting can be changed each time you change pages. When using the automatic document feeder, the exposure setting cannot be changed once scanning has begun. (However, when "Job Build" is used in the special modes, the exposure can be changed each time a new set of originals is inserted.)

 **System Settings (Administrator): Default Exposure Settings**  
This is used to change the default exposure setting.

# CHANGING THE RESOLUTION

The resolution setting can be selected.

## 1

Select the mode and display the image settings screen.

- (1) Touch the tab of the mode that you wish to use.
- (2) Touch the [Resolution] key.

 [IMAGE SETTINGS](#) (page 5-53)

## 2

Scan mode, USB memory mode, Data entry mode

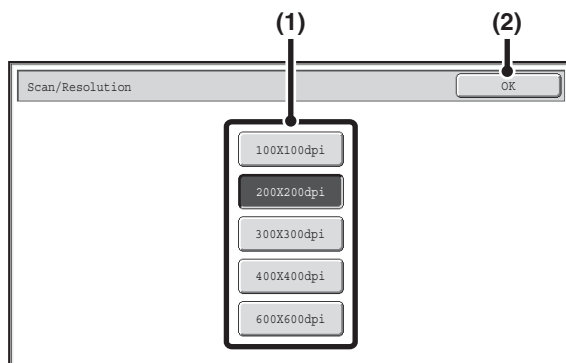

Select the resolution.

- (1) Touch the key of the desired resolution.
- (2) Touch the [OK] key.

Internet fax mode

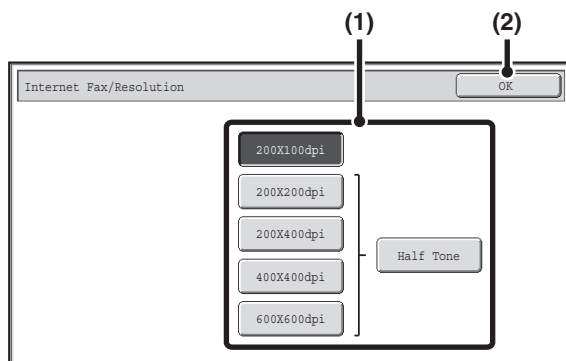

In Internet fax mode, the [Half Tone] key can be touched to select halftone (except when [200X100dpi] is selected). When the original has many gradations of light and dark such as a photo or colour illustration, halftone provides a more attractive image than regular transmission.

## How to select the resolution

For normal text originals, 200X200dpi (200X100dpi in Internet fax mode) produces an image that is sufficiently legible. For photos and illustrations, a high resolution setting (600X600dpi, etc.) will produce a sharp image. However, a high resolution setting will result in a large file, and if the file is too large, transmission may not be possible. In this event, reduce the number of pages scanned or take other measures to decrease the file size.

 [CHANGING THE FILE FORMAT](#)

 [Specifying the send size of the image](#) (page 5-59)



- When using the document glass to scan multiple original pages, the resolution setting can be changed each time you change pages. When using the automatic document feeder, the resolution setting cannot be changed once scanning has begun. (However, when "Job Build" is used in the special modes, the resolution can be changed each time a new set of originals is inserted.)
- When [TIFF-S] is selected for the format in Internet fax mode, only [200X100dpi] or [200X200dpi] can be selected.



### System Settings (Administrator): Initial Resolution Setting

This is used to change the default resolution setting.

## CHANGING THE FILE FORMAT

### Changing the format

#### (Scan mode, USB memory mode and Data entry mode)

The file format (file type and compression mode/compression ratio) for sending a scanned image can be changed at the time of transmission. In addition, if the scanned originals are divided into separate files, the number of pages per file can be changed.



The file format for sending a scanned image is specified when the destination is stored in a one-touch key; however, you can change the format at the time of transmission.

# 1

### Select the mode and display the image settings screen.

- (1) Touch the tab of the mode that you wish to use.
- (2) Touch the [File Format] key.

 [IMAGE SETTINGS](#) (page 5-53)

# 2

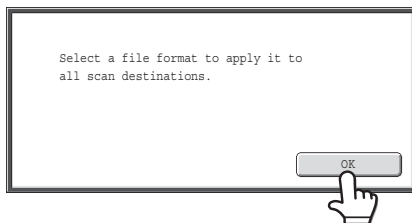

### Read the displayed message and touch the [OK] key.

The message does not appear in USB memory mode. Go to the next step.

## Set the format.

### ● Scanning in Mono2

- (1) Select the file type.
- (2) Select the compression mode.

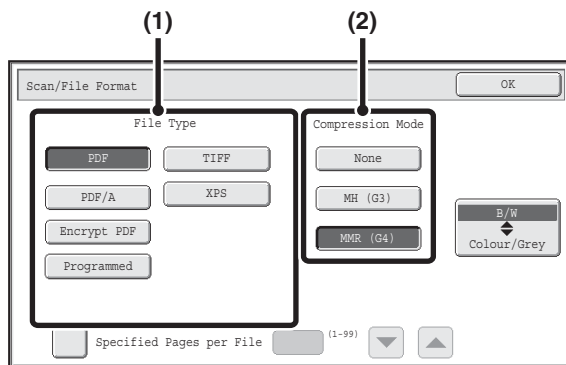

### ● Scanning in colour/greyscale

- (1) Touch the indicated key to select [Colour/Grey] mode.  
When [Colour/Grey] is highlighted, [Colour/Grey] mode is selected.
- (2) Select the file type.
- (3) Select the compression ratio.
  - High results in a smaller file size, however, the image quality is slightly degraded.
  - When [High] is selected in the file format settings, the compression ratio cannot be selected.

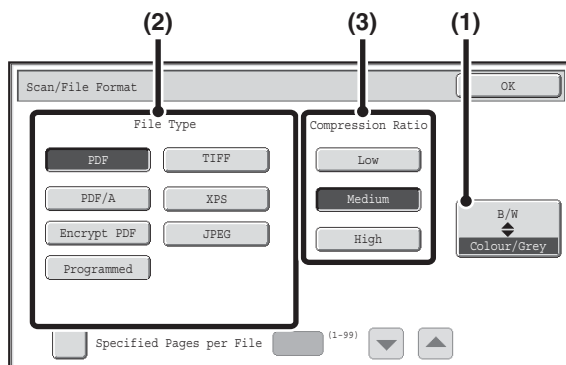

- The [Programmed] key does not appear in USB memory mode.
- When this screen is displayed, the setting screen of [B/W] mode initially appears.
- The format setting for [B/W] mode is the file format that is used when the [BLACK & WHITE START] key is pressed with the B/W mode set to [Mono2].
- The format setting for [Colour/Grey] mode is the file format that is used when the [COLOUR START] key is pressed, or when the [BLACK & WHITE START] key is pressed with the B/W mode set to [Greyscale].
- The file type of [B/W] mode and the file type of [Colour/Grey] mode are linked. The file type cannot be set separately for each. (When [JPEG] is selected for [Colour/Grey] mode, [TIFF] is automatically selected for [B/W] mode.)

4

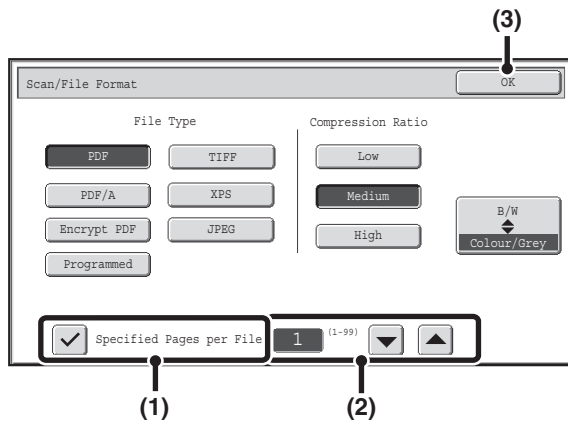

To change the number of pages per file, enter the number of pages and exit the format settings.

- (1) Touch the [Specified Pages per File] checkbox so that a checkmark  appears.
- (2) Set the number of pages per file with the   keys.
- (3) Touch the [OK] key.



- When a checkmark does not appear in the [Specified Pages per File] checkbox , one file is created for all scanned pages.
- When [Specified Pages per File] is selected, consecutive numbers are added to the created file names.
- When [JPEG] is selected for the file type, one file is created for each page (a file cannot be created for multiple pages). For this reason, the [Specified Pages per File] checkbox does not appear.



- When the file format is set to Encrypt PDF, a screen prompting you to enter a password will appear when the [START] key is pressed to start scan send transmission.
- Touch the [Entry] key in the displayed screen to open the keyboard screen. Enter a password (maximum of 32 characters) and touch the [OK] key. Scanning and transmission will begin.



#### System Settings (Administrator): Initial File Format Setting

This sets the default file format setting for scanner transmission.

## Changing the format (Internet fax mode)

The file format for sending an Internet fax is normally set to [TIFF-F]. If the destination Internet fax machine does not support full mode (it only supports simple mode), follow the steps below to select [TIFF-S].

### 1 Switch to Internet fax mode and display the file format settings screen.

1

- (1) Touch the [Internet Fax] tab.
- (2) Touch the [File Format] key.

 [IMAGE SETTINGS](#) (page 5-53)

2

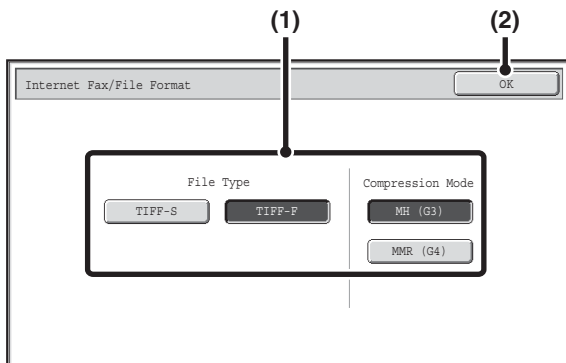

### Select the file format.

- (1) Touch the key of the desired format.  
If you selected [TIFF-F], select the compression mode.
- (2) Touch the [OK] key.

-  When [TIFF-S] is selected, the transmission settings are restricted as follows:
- Resolution: The selections are [200X100dpi] and [200X200dpi]. If [TIFF-S] is selected after [200X400dpi], [400X400dpi] or [600X600dpi] is selected, the resolution automatically changes to [200X200dpi].
  - Send size: Always A4R (8-1/2" x 11"R). If [TIFF-S] is selected after the send size is changed, the send size is automatically changed to A4R (8-1/2" x 11"R). If a size larger than A4 (8-1/2" x 11") is scanned, the size will automatically be reduced to A4R (8-1/2" x 11"R). When this format is included in a broadcast transmission, the image will be transmitted to all destinations at A4R (8-1/2" x 11"R).
  - Special modes: When a ratio setting is selected and the original size is entered, Dual Page Scan, Card Shot, 2in1, and Mixed Size Original cannot be used.

-  **System Settings (Administrator): Compression Setting**  
This is used to set the default compression mode for Internet fax transmission.

# CHANGING THE COLOUR MODE

This procedure is used to change the colour mode used to scan the original when the [COLOUR START] key or the [BLACK & WHITE START] key is pressed.

 This function cannot be used in Internet fax mode.

Start key	Mode	Scanning method
[COLOUR START] key	Auto	The machine detects whether the original is colour or black and white and automatically selects full colour or black and white (Mono2 or Greyscale) scanning.
	Full Colour	The original is scanned in full colour. This mode is best for full colour originals such as catalogues.
[BLACK & WHITE START] key	Mono2	Colours in the original are scanned as black or white. This mode is best for text-only originals.
	Greyscale	The colours in the original are scanned in black and white as shades of grey (greyscale).

## 1 Select the mode and display the colour mode settings screen.

- (1) Touch the tab of the mode that you wish to use.
- (2) Touch the [Colour Mode] key.

 [IMAGE SETTINGS](#) (page 5-53)

## 2

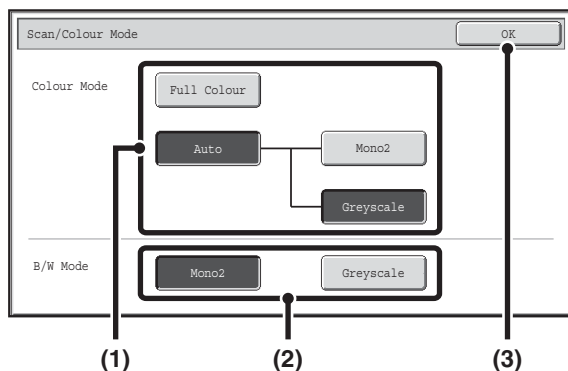

## Select the colour mode.

- (1) Touch the key of the mode to be used when the [COLOUR START] key is pressed.

You can select whether black & white scanning will take place in Mono2 or greyscale when [Auto] is selected and a black and white original is scanned. Note that if the file format is set to JPEG, scanning will take place in greyscale.

- (2) Touch the key of the mode to be used when the [BLACK & WHITE START] key is pressed.
- (3) Touch the [OK] key.



- **System Settings (Administrator): Default Colour Mode Settings**

The default colour mode can be changed.

- **System Settings (Administrator): Disable Change of B/W Setting in Auto Mode**

This prohibits selection of the black and white original scanning setting when [Auto] is selected for the colour mode.

# CHECKING THE IMAGE TO BE TRANSMITTED (Preview)

(On the MX-2314N, the productivity kit is required.)

If you touch the [Preview] key before scanning the original, you can check the scanned image in the touch panel before sending the image.

\* The factory default setting is disabled.



Depending on the size of the transmission data, part of the preview image may not appear in the preview screen in the touch panel.

## 1

### Place the original.

Place the original in the document feeder tray or on the document glass as appropriate for the functions stored in the program.

## 2

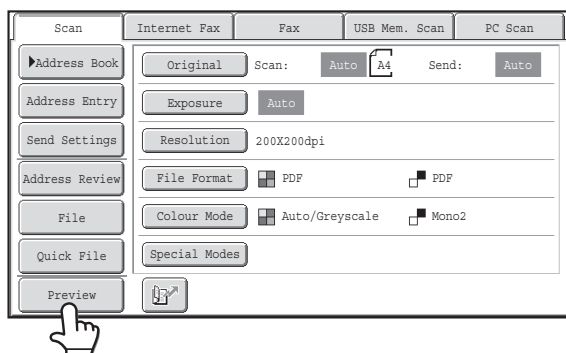

Touch the [Preview] key to highlight it.

## 3

### Select transmission settings and touch the [COLOUR START] key or the [BLACK & WHITE START] key.

"Originals are being read" appears while the originals are being scanned, and when scanning is finished, the preview screen appears on the touch panel. Transmission will not take place until you touch the [Start Sending] key in the preview screen.

## 4

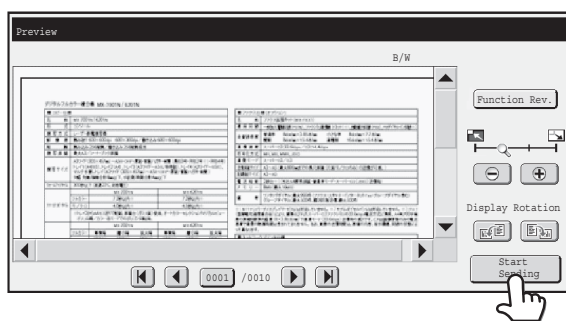

### Check the preview image and then touch the [Start Sending] key.

Transmission begins.

For information on the preview screen, see "[PREVIEW CHECK SCREEN](#)" (page 5-70).



#### System settings (administrator): Default Preview

You can specify whether or not the [Preview] key function will be enabled in the base screens of the image send modes and in the address book.



# PREVIEW CHECK SCREEN

This section explains the preview check screen.

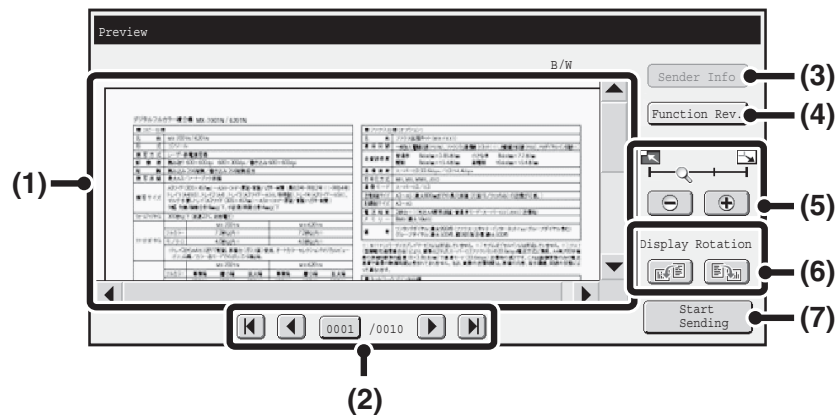

## (1) Preview image

A preview of the scanned original appears. If the image is cut off, use the scroll bars at the right and bottom of the screen to scroll the image. Touch a bar and slide it to scroll. (You can also touch the keys to scroll.)

## (2) Change page keys

When there are multiple pages, use these keys to change pages.

- keys: Go to the first or the last page.
- keys: Go to the previous page or the next page.
- Page number display:
  - This shows the total number of pages and the current page number. You can touch the current page number key and enter a number with the numeric keys to go to that page number.

## (3) [Sender Info] key

When Internet fax mode is selected, touch to display the sender information for I-fax own address send. This key can only be touched when the entire preview image is displayed in the preview screen.

## (4) [Function Rev.] key

Touch to check special mode settings or scan settings for two-sided originals.

## (5) Display zoom key

Use this to set the zoom ratio of the displayed image. Changes from the left in the order "Full Page", "Twice", "4 Times", "8 Times". The setting applies to all pages in the file, not just the displayed page.

## (6) "Display Rotation" key

This rotates the image right or left by 90 degrees. The rotation applies to all pages in the file, not just the displayed page.

## (7) [Start Sending] key

Touch to begin transmission.



- A preview image is an image for display on the touch panel. It will differ from the actual print result.
- The preview image reflects certain scanning and special mode settings. Settings reflected in the preview image are as follows:  
Scanning settings: Original  
Special modes: Erase, Dual Page Scan, Card Shot, 2in1, Blank Page Skip

# SPECIAL MODES

This section explains special modes that can be used in scan send mode.

## SPECIAL MODES

When the [Special Modes] key is touched in the base screen, the special modes menu screen appears. The special modes menu consists of two screens. Touch the  $\downarrow$   $\uparrow$  key to switch between the two screens. When the [OK] key is touched in the special modes screen, the selected settings are entered and the base screen reappears.

[Internet fax mode](#) (page 5-72)

### Scan mode, USB memory mode, Data entry mode

#### 1st screen

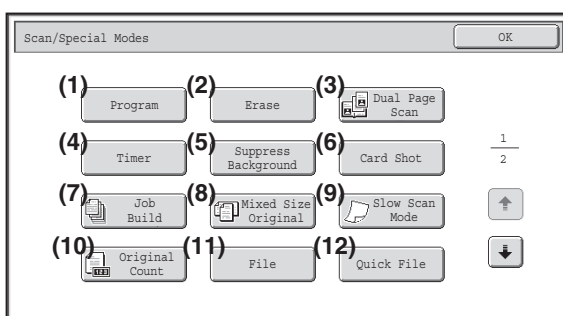

#### 2nd screen

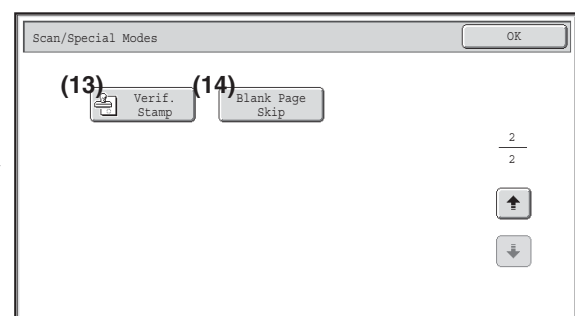

- |   |                                     |  |
|---|-------------------------------------|--|
| <p>(1) <b>[Program] key*1, 2</b><br/> <a href="#">STORING SCAN OPERATIONS (Programs)</a> (page 5-73)</p> <p>(2) <b>[Erase] key</b><br/> <a href="#">ERASING PERIPHERAL SHADOWS ON THE IMAGE (Erase)</a> (page 5-75)</p> <p>(3) <b>[Dual Page Scan] key</b><br/> <a href="#">SCANNING AN ORIGINAL AS TWO SEPARATE PAGES (Dual Page Scan)</a> (page 5-77)</p> <p>(4) <b>[Timer] key*1, 4</b><br/> <a href="#">SENDING AN IMAGE AT A SPECIFIED TIME (Timer Transmission)</a> (page 5-79)</p> <p>(5) <b>[Suppress Background] key</b><br/> <a href="#">WHITENING FAINT COLOURS IN THE IMAGE (Suppress Background)</a> (page 5-81)</p> <p>(6) <b>[Card Shot] key</b><br/> <a href="#">SCANNING BOTH SIDES OF A CARD ONTO A SINGLE PAGE (Card Shot)</a> (page 5-83)</p> <p>(7) <b>[Job Build] key</b><br/> <a href="#">SCANNING MANY ORIGINALS AT ONCE (Job Build)</a> (page 5-86)</p> <p>(8) <b>[Mixed Size Original] key</b><br/> <a href="#">SCANNING ORIGINALS OF DIFFERENT SIZES (Mixed Size Original)</a> (page 5-88)</p> | <p><math>\leftrightarrow</math></p> | <p>(9) <b>[Slow Scan Mode] key</b><br/> <a href="#">SCANNING THIN ORIGINALS (Slow Scan Mode)</a> (page 5-90)</p> <p>(10) <b>[Original Count] key*1</b><br/> <a href="#">CHECKING THE NUMBER OF SCANNED ORIGINAL SHEETS BEFORE TRANSMISSION (Original Count)</a> (page 5-92)</p> <p>(11) <b>[File] key*1, 4</b><br/>           Touch this to use the File function of document filing mode.</p> <p>(12) <b>[Quick File] key*1, 4</b><br/>           Touch this to use the Quick File function of document filing mode.</p> <p>(13) <b>[Verif. Stamp] key*3</b><br/> <a href="#">STAMPING SCANNED ORIGINALS (Verif. Stamp)</a> (page 5-94)</p> <p>(14) <b>[Blank Page Skip] key</b><br/> <a href="#">ELIMINATING BLANK PAGES FROM A TRANSMISSION (Blank Page Skip)</a> (page 5-96)</p> |
|---|-------------------------------------|--|

\*1 Does not appear in USB memory mode.

\*2 Does not appear in data entry mode.

\*3 Does not appear when the stamp unit is not installed.  
 In USB memory mode, this appears in the 1st screen.

\*4 On the MX-2314N, the productivity kit is required.

## Internet fax mode

The keys explained below can only be used in Internet fax mode. The other keys are the same as those explained in "Scan mode, USB memory mode, Data entry mode" (page 5-71).

### 1st screen

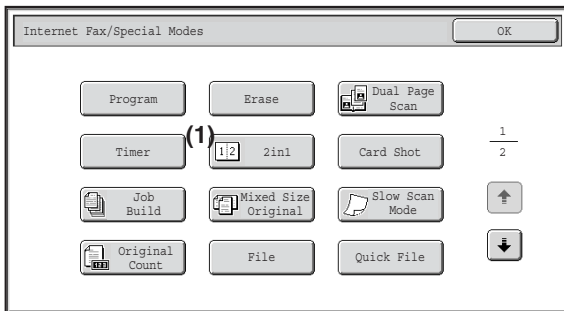

### 2nd screen

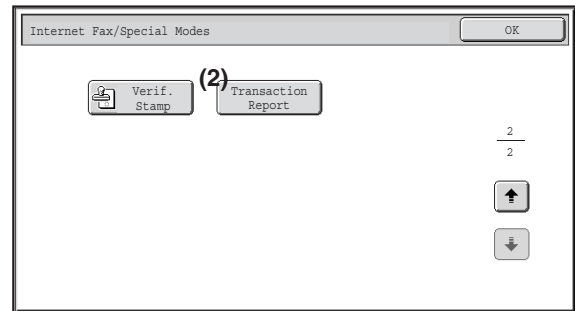

**(1) [2in1] key**

☞ [SENDING TWO PAGES AS A SINGLE PAGE \(2in1\)](#)  
(page 5-98)

**(2) [Transaction Report] key**

☞ [CHANGING THE PRINT SETTINGS FOR THE TRANSACTION REPORT \(Transaction Report\)](#)  
(page 5-101)

 Special modes can generally be combined with other special modes, however, there are some combinations that are not possible. If a prohibited combination is selected, a message will appear in the touch panel.

## [OK] key and [Cancel] key

In some cases two [OK] keys and one [Cancel] key will appear in the special mode screens. The keys are used as follows:

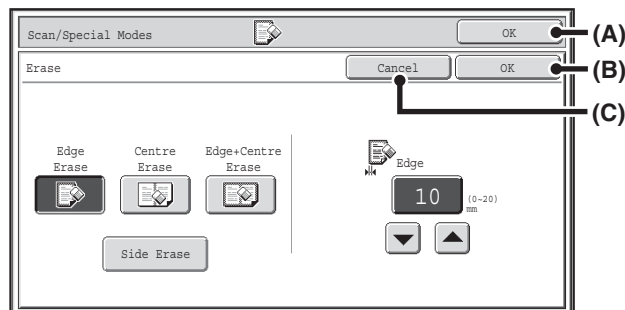

- (A) Enter the selected special mode setting and return to the base screen.
- (B) Enter the selected special mode setting and return to the special mode menu screen. Touch this key when you wish to continue selecting other special mode settings.
- (C) During selection of special mode settings, this key returns you to the special mode menu screen without saving the settings. When settings have been completed, this cancels the settings and returns you to the special mode menu screen.

# STORING SCAN OPERATIONS (Programs)

A destination, original settings, and functions can be stored in a program. When you wish to use those settings to send an image, they can be retrieved with ease.

For example, suppose A4 (8-1/2" x 11") size documents are scanned into a file and sent to each branch office once a month.

- (1) The same documents are sent to each branch office
- (2) Each page of a bound document is successively transmitted
- (3) Smudges on the edges of the documents are erased before transmission

When a job program is not stored	When a job program is stored
<p>Enter the address of each branch office.</p> <p style="text-align: center;">↓</p> <p>Select Dual Page Scan</p> <p style="text-align: center;">↓</p> <p>Select Erase settings</p> <p style="text-align: center;">↓</p> <p>Press the [START] key. The originals are scanned and transmitted.</p>	<p>Touch a stored program key.</p> <p style="text-align: center;">↓</p> <p>Press the [START] key. The originals are scanned and transmitted.</p>
<p>Considerable time is required to send the documents each month because the above settings must be selected. In addition, mistakes may occasionally be made when selecting the settings, so incorrect transmissions may occur.</p>	<p>When a program is used, settings are selected with ease by simply pressing the stored key. In addition, transmission takes place based on the stored settings so there are no chances for mistakes.</p>



- **Programs are stored, edited, and deleted using "Address Control" in the system settings. See "Program" (page 7-21) in "7. SYSTEM SETTINGS".**
- Programs can also be stored in the Web pages. Click [Job Programs] and then [Image Send] in the Web page menu.
- The settings stored in a program will be retained even after the program is used for transmission. The same settings can be used repeatedly for transmission.
- The following settings can be stored in programs.
  - Image send mode: Scan, Internet fax
  - Destinations
  - Image settings: Original scan size, original orientation, duplex scanning, exposure, resolution
  - Special modes: Erase, Dual Page Scan, Suppress Background, Job Build, Mixed Size Original, Slow Scan Mode, Original Count, Verif. Stamp, Blank Page Skip, 2in1
- Up to 48 programs can be stored.
- Up to 500 destinations can be stored in one program.
- This function cannot be used in USB memory mode or data entry mode.

## 1

### Place the original.

Place the original in the document feeder tray or on the document glass as appropriate for the functions stored in the program.

## Select the special modes.

2

- (1) Touch the [Special Modes] key.
- (2) Touch the [Program] key.

 [SPECIAL MODES](#) (page 5-71)

3

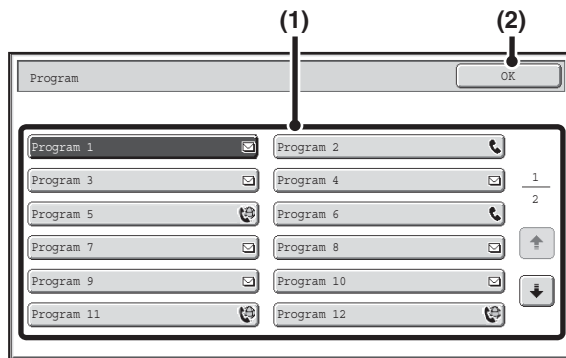

## Retrieve the stored program.

- (1) Touch the desired program key.
- (2) Touch the [OK] key.

4

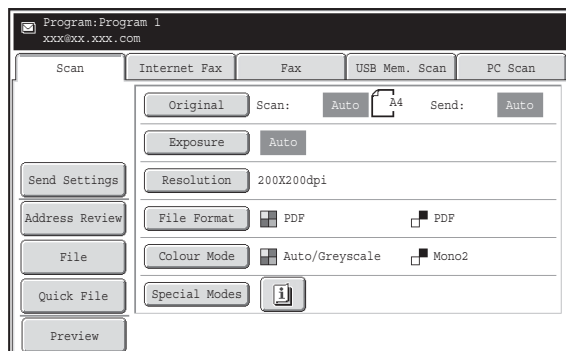

## Select additional settings.

When a program is used, the following settings can be additionally specified:

- Image Settings: Original scan size\*, send size, file format, colour mode
- Send settings
- Special modes: Timer Transmission, Card Shot, File, Quick File, Transaction Report

\* When stored in the program, this cannot be additionally specified.



- The screen that appears will vary depending on the destination stored in the program.
- The mode cannot be changed here.
- Functions stored in the program cannot be cancelled here.

5

## Press the [COLOUR START] key or the [BLACK & WHITE START] key.

Scanning begins.

- If you inserted the original pages in the document feeder tray, all pages are scanned. A beep will sound to indicate that scanning is finished.
- If you are scanning the original on the document glass, scan each page one page at a time. When scanning finishes, place the next original and press the [COLOUR START] key or the [BLACK & WHITE START] key. Repeat until all pages have been scanned and then touch the [Read-End] key. A beep will sound to indicate that scanning is finished.



### To cancel scanning...

Press the [STOP] key () to cancel the operation.

# ERASING PERIPHERAL SHADOWS ON THE IMAGE (Erase)

The erase function is used to erase shadows on images produced when scanning thick originals or books. (This function erases the parts of the image where shadows tend to form. The function does not detect shadows and erase only the shadows.)

## Scanning a thick book

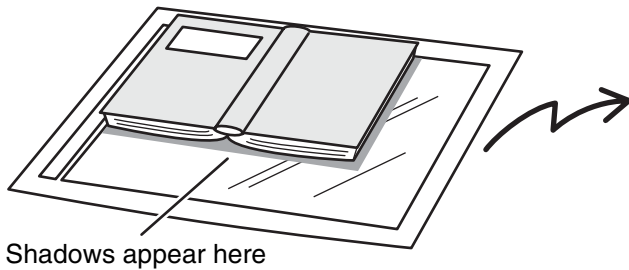

Not using the erase function	Using the erase function
<p>Shadows appear in the image.</p>	<p>No shadows appear.</p>

## Erase modes

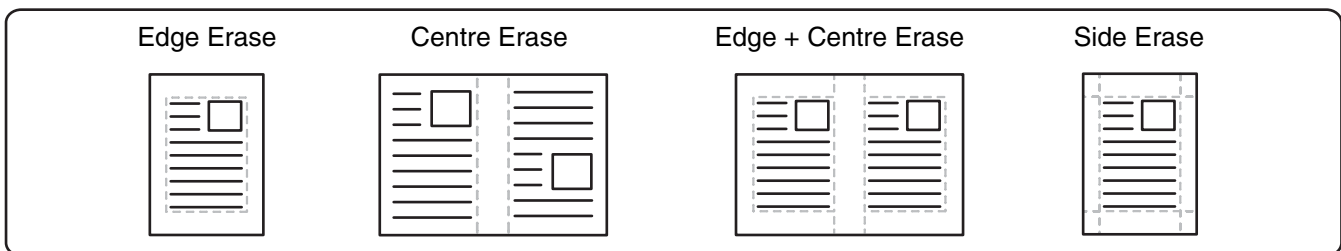

- Shadows at the edges of the original can also be erased when the automatic document feeder is used.
- When using USB memory mode, connect the USB memory device to the machine before performing the procedure below.

### 1 Place the original.

Place the original face up in the document feeder tray, or face down on the document glass.

### 2 Specify the destination.

[ENTERING DESTINATIONS](#) (page 5-18)

2



When scanning to USB memory, there is no need to specify the destination. Go to step 3.

### 3 Select the special modes.

(1) Touch the tab of the mode that you wish to use.

3

(2) Touch the [Special Modes] key.

(3) Touch the [Erase] key.

[SPECIAL MODES](#) (page 5-71)

4

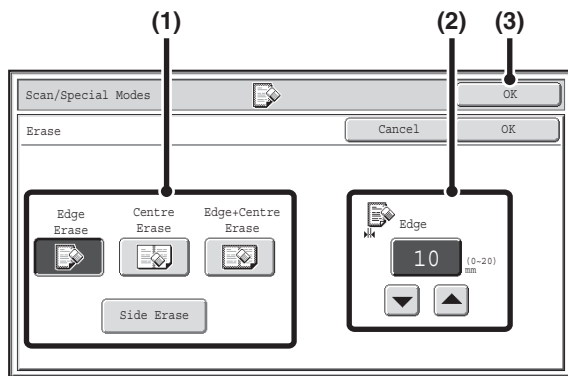

## Select the erase settings.

### (1) Touch the desired erase mode.

Select one of the 4 erase modes.

Touch the [Side Erase] key to open the following screen.

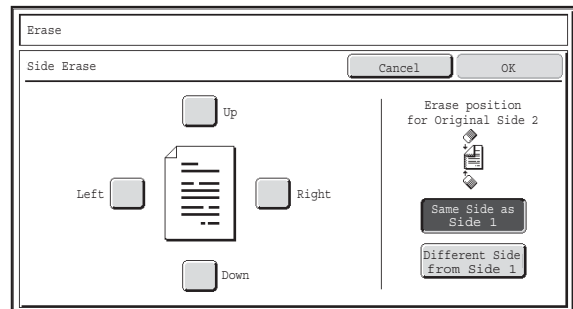

Touch the checkbox of the edge that you wish to erase and make sure that a checkmark () appears.

When performing two-sided scanning, set the erase edge on the reverse side.

- If you touch the [Same Side as Side 1] key, the edge in the same position as on the front side will be erased.
- If you touch the [Different Side from Side 1], the edge in the position opposite to the erased edge on the front side will be erased.

When you have completed the settings, touch the [OK] key.

### (2) Set the erasure width with the keys.

0 mm to 20 mm (0" to 1") can be entered.

### (3) Touch the [OK] key.

5

## Press the [COLOUR START] key or the [BLACK & WHITE START] key.

Scanning begins.

- If you inserted the original pages in the document feeder tray, all pages are scanned. A beep will sound to indicate that scanning is finished.
- If you are scanning the original on the document glass, scan each page one page at a time. When scanning of one page finishes, replace it with the next page and press the [COLOUR START] key or the [BLACK & WHITE START] key. Repeat until all pages have been scanned and then press the [Read-End] key. A beep will sound to indicate that scanning is finished.



If the destination is an Internet fax destination, press the [BLACK & WHITE START] key.



#### To cancel scanning...

Press the [STOP] key () to cancel the operation.



When the erase function is used, erase takes place at the edges of the original image. If you also use a reduction or an enlargement setting, the erase width will change according to the selected ratio. For example, if the erase width setting is 20 mm (1") and the image is reduced to 50%, the erase width will be 10 mm (1/2").



#### To cancel the erase setting...

Touch the [Cancel] key in the screen of step 4.



#### System Settings (Administrator): Erase Width Adjustment

The default erase width setting is linked to the copy mode system setting, and can be set from 0 mm to 20 mm (0" to 1"). The factory default setting is 10 mm (1/2").

# SCANNING AN ORIGINAL AS TWO SEPARATE PAGES (Dual Page Scan)

The left and right sides of an original can be scanned as two separate pages. This function is useful when you wish to successively scan each page of a book or other bound document.

**Example: Scanning the left and right pages of a book**

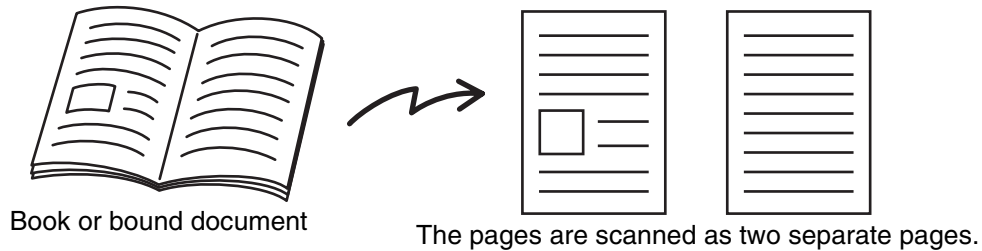

**Example:**

Original scan size	Transmitted image
A3 (11" x 17") x 1 page	A4 (8-1/2" x 11") x 2 pages

- When using dual page scan, the original must be placed on the document glass.
- The send size cannot be changed.
- When using USB memory mode, connect the USB memory device to the machine before performing the procedure below.

1

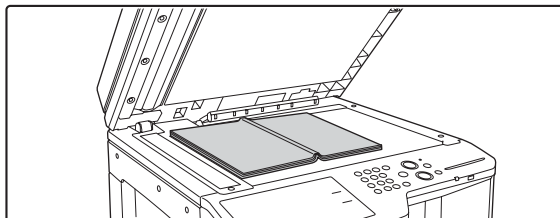

**Place the original face down on the document glass.**

Align the centre of the original with the appropriate size mark ▼.

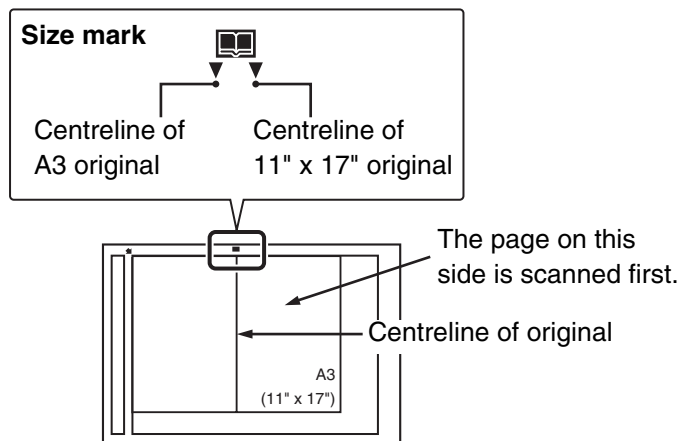

2

**Specify the destination.**

📖 [ENTERING DESTINATIONS](#) (page 5-18)

- When scanning to USB memory, there is no need to specify the destination. Go to step 3.



### Select the special modes.

3

- (1) Touch the tab of the mode that you wish to use.
- (2) Touch the [Special Modes] key.

 [SPECIAL MODES](#) (page 5-71)

4

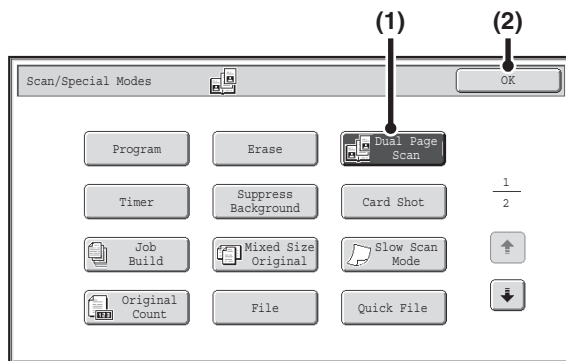

### Select Dual Page Scan.

- (1) Press the [Dual Page Scan] key so that it is highlighted.
- (2) Touch the [OK] key.

### Press the [COLOUR START] key or the [BLACK & WHITE START] key.

Scanning begins.



When scanning finishes, place the next original and press the [COLOUR START] key or the [BLACK & WHITE START] key.

Repeat until all pages have been scanned and then touch the [Read-End] key.

A beep will sound to indicate that scanning is finished.

5

 If the destination is an Internet fax destination, press the [BLACK & WHITE START] key.

 **To cancel scanning...**  
Press the [STOP] key () to cancel the operation.

-  • To erase shadows caused by the binding of a book or other bound document, use the erase function. (Note, however, that "Centre Erase" and "Edge + Centre Erase" cannot be used.)
- When the scan size of the original is specified by numerical values, this function cannot be used.

 **To cancel the dual page scan setting...**  
Touch the [Dual Page Scan] key in the screen of step 4 so that it is no longer highlighted, and touch the [OK] key.

# SENDING AN IMAGE AT A SPECIFIED TIME (Timer Transmission)

(On the MX-2314N, the productivity kit is required.)

This function lets you specify a time at which a transmission or broadcast transmission will automatically take place. Transmission begins automatically at the specified time.

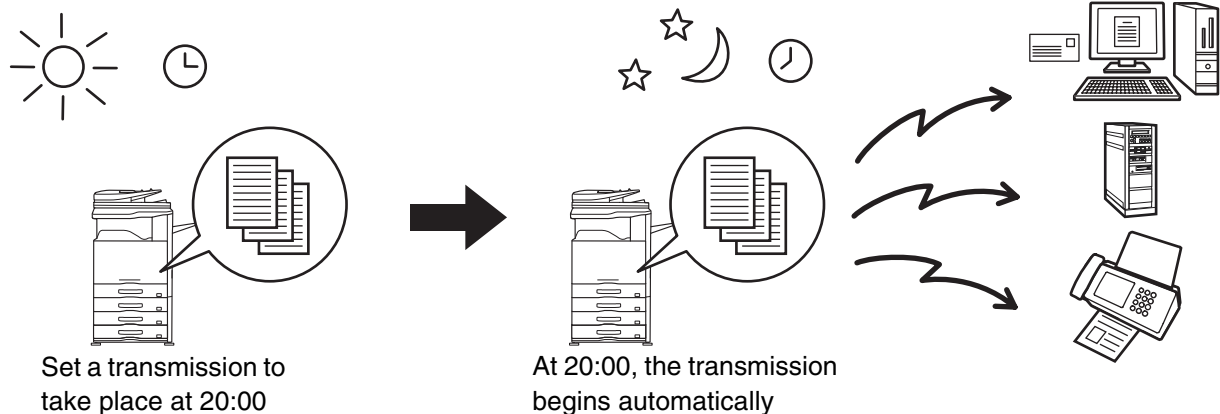

- When a timer transmission is stored, keep the main power switch in the "on" position. If the main power switch is in the "off" position at the specified time, transmission will not take place.
- When performing a timer transmission, you must scan the original into memory when you set up the transmission. It is not possible to leave the document in the auto document feeder or on the document glass and have it scanned at the specified time of transmission.
- Settings selected for a timer transmission (exposure, resolution, special modes, etc.) are automatically cleared after the transmission is finished. (However, when the document filing function is used, the scanned original and settings are stored on the built-in hard drive.)
- This function cannot be used in USB memory mode.

## 1 Place the original.

Place the original face up in the document feeder tray, or face down on the document glass.

## 2 Specify the destination.

 [ENTERING DESTINATIONS](#) (page 5-18)

## 3 Select the special modes.

(1) Touch the tab of the mode that you wish to use.

(2) Touch the [Special Modes] key.

(3) Touch the [Timer] key.

 [SPECIAL MODES](#) (page 5-71)

4

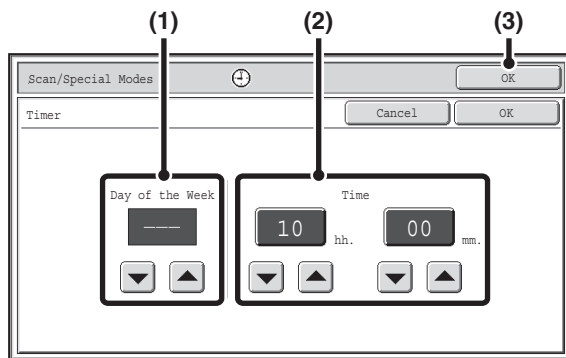

Set the time with the   keys.

**(1) Specify the day.**

If you do not wish to specify a day, select [---]. In this case, transmission will begin when the time specified in (2) arrives.

**(2) Specify the time (hour, minute)**

Select the time in 24-hour format.

You can also directly touch a numeric display key to change the setting with the numeric keys.

**(3) Touch the [OK] key.**



When this screen is opened, the setting will show the current time. If the time is not correct, press the [CLEAR ALL] key (CA) to cancel the operation. Correct the time in the system settings and then perform the timer transmission procedure.

 [CHECKING THE DATE AND TIME](#) (page 5-5)

5

**Press the [COLOUR START] key or the [BLACK & WHITE START] key.**

Scanning begins.

- If you inserted the original pages in the document feeder tray, all pages are scanned. A beep will sound to indicate that scanning is finished.
- If you are scanning the original on the document glass, scan each page one page at a time. When scanning finishes, place the next original and press the [COLOUR START] key or the [BLACK & WHITE START] key. Repeat until all pages have been scanned and then touch the [Read-End] key. A beep will sound to indicate that scanning is finished.



- If the destination is an Internet fax destination, press the [BLACK & WHITE START] key.
- The original is scanned into memory. The original cannot be scanned at a specified time.



**To cancel scanning...**

Press the [STOP] key (⏹) to cancel the operation.



- The time can be specified up to a week in advance.
- Up to 94 timer transmissions can be stored at once.
- If another transmission is in progress when the specified time arrives, the timer transmission will begin after that transmission is finished.
- Other transmissions can be performed as usual after a timer transmission is stored.
- A timer transmission can be deleted in the job status screen.
- If a timer transmission is given priority in the job status screen, the time specification is cancelled. The transmission will begin as soon as the job in progress is completed.

 [GIVING PRIORITY TO A SCAN TRANSMISSION JOB](#) (page 5-110)



**To cancel timer transmission...**

Touch the [Cancel] key in the screen of step 4.

# WHITENING FAINT COLOURS IN THE IMAGE (Suppress Background)

This feature is used to suppress light background areas.

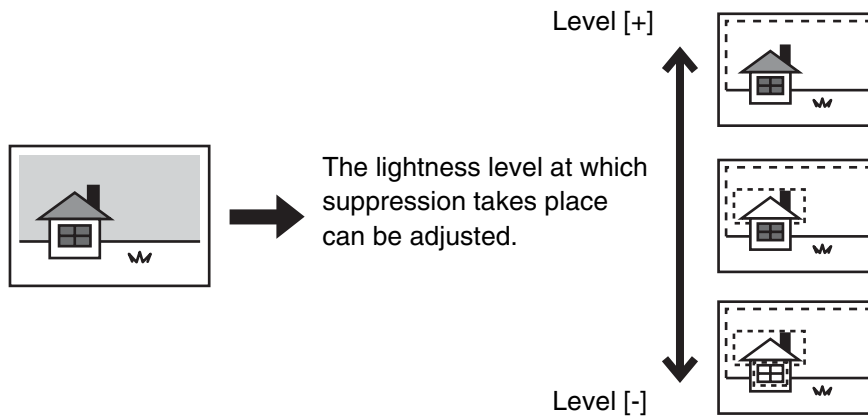

- This function cannot be used in Internet fax mode.
- When using USB memory mode, connect the USB memory device to the machine before performing the procedure below.

1

## Place the original.

Place the original face up in the document feeder tray, or face down on the document glass.

2

## Specify the destination.

 [ENTERING DESTINATIONS](#) (page 5-18)

 When scanning to USB memory, there is no need to specify the destination. Go to step 3.

3

## Select the special modes.

- (1) Touch the tab of the mode that you wish to use.
- (2) Touch the [Special Modes] key.
- (3) Touch the [Suppress Background] key.

Read the message that appears and then touch the [OK] key.

 [SPECIAL MODES](#) (page 5-71)

4

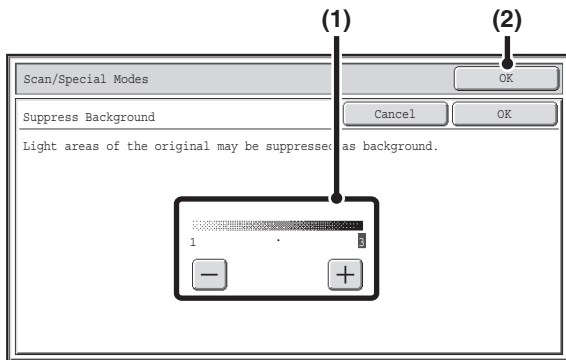

### Select the suppress background setting.

#### (1) Adjust the background suppression level.

Touch the [+] key to suppress only faint background.  
Touch the [-] key to suppress faint to dark background.

#### (2) Touch the [OK] key.



5

### Press the [COLOUR START] key or the [BLACK & WHITE START] key.

Scanning begins.

- If you inserted the original pages in the document feeder tray, all pages are scanned. A beep will sound to indicate that scanning is finished.
- If you are scanning the original on the document glass, scan each page one page at a time. When scanning finishes, place the next original and press the [COLOUR START] key or the [BLACK & WHITE START] key. Repeat until all pages have been scanned and then touch the [Read-End] key. A beep will sound to indicate that scanning is finished.

 When the colour mode setting of the [BLACK & WHITE START] key is [Mono2], the suppress background function will not operate if the [BLACK & WHITE START] key is pressed.

 **To cancel scanning...**  
Press the [STOP] key () to cancel the operation.

 **To cancel the background suppression setting...**  
Touch the [Cancel] key in the screen of step 4.

# SCANNING BOTH SIDES OF A CARD ONTO A SINGLE PAGE (Card Shot)

This function lets you send the front and reverse sides of a card as a single page, without the need to send each side separately.

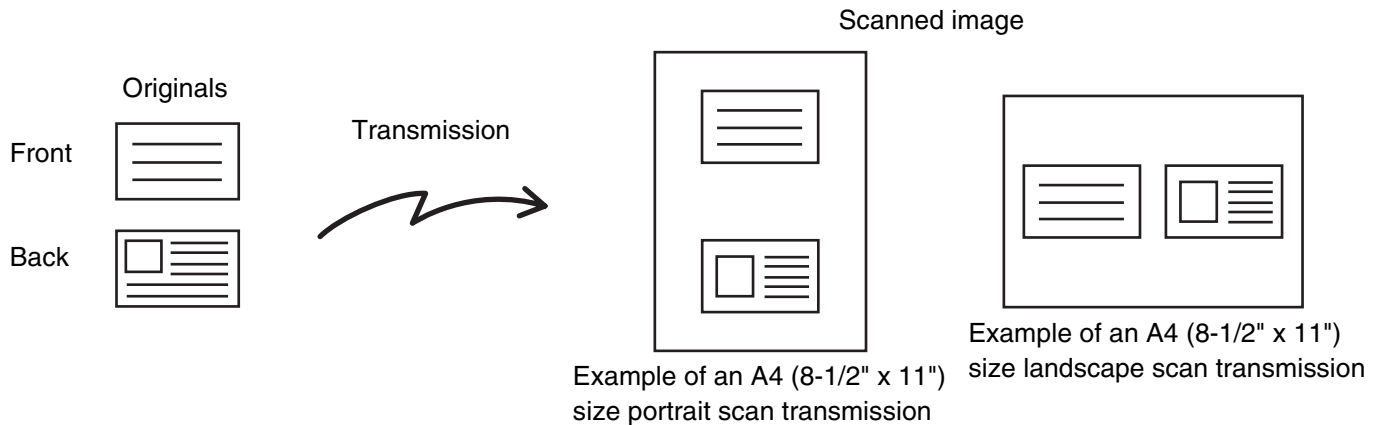

- When using card shot, the original must be placed on the document glass.
- When using USB memory mode, connect the USB memory device to the machine before performing the procedure below.

1

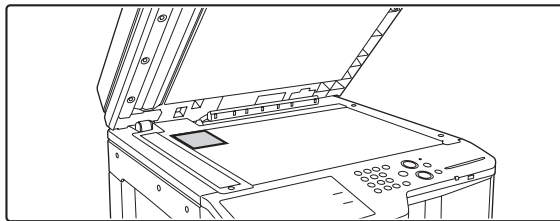

**Place the original face down on the document glass.**

2

## Specify the destination.

☞ [ENTERING DESTINATIONS](#) (page 5-18)



When scanning to USB memory, there is no need to specify the destination. Go to step 3.

3

## Select the special modes.

(1) Touch the tab of the mode that you wish to use.

(2) Touch the [Special Modes] key.

(3) Touch the [Card Shot] key.

☞ [SPECIAL MODES](#) (page 5-71)

4

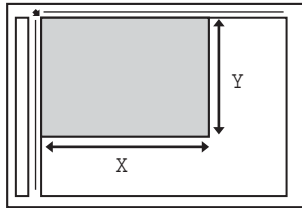
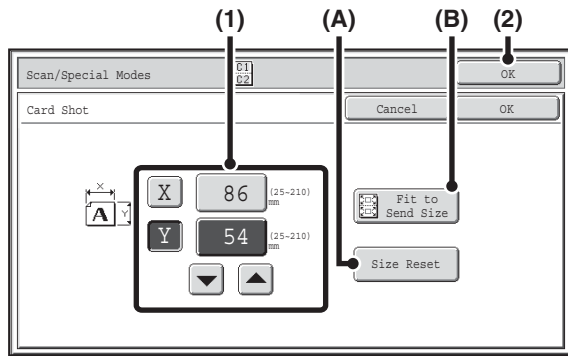

## Specify the original size.

### (1) Enter the original size.

- Touch the X (width) numeric value display key and enter the width.
- Touch the Y (height) numeric value display key and enter the height.

(A) To return the original size to the default size, touch the [Size Reset] key.

(B) To automatically enlarge or reduce the image to fit the send size, touch the [Fit to Send Size] key. If you wish to scan the original at the entered original size, there is no need to touch this key.

### (2) Touch the [OK] key.



- You can also touch the keys to change the number.
- The send size will be selected automatically based on the entered original size.
- After selecting Card Shot, you can touch the [Original] key in the base screen to change the original scan size or the send size. In this case, the screen of this step appears when you touch the scan size key. For the procedure for setting the send size, see "[Specifying the send size of the image](#)" (page 5-59).

5



If the destination is an Internet fax destination, press the [BLACK & WHITE START] key.



#### To cancel scanning...

Press the [STOP] key () to cancel the operation.

6



Before scanning the back of the card, you can touch the [Configure] key in the touch panel to change the exposure.



#### To cancel scanning...

Press the [STOP] key () to cancel the operation.

## Press the [COLOUR START] key or the [BLACK & WHITE START] key to scan the front side of the card.

## Turn the card over and press the [COLOUR START] key or the [BLACK & WHITE START] key to scan the reverse side of the card.

Press the same [START] key that was used to scan the front side.

7

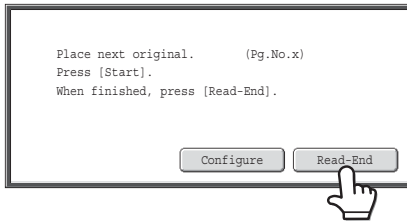

Touch the [Read-End] key.



If you will continue by scanning the front of the card, you can touch the [Configure] key to change the exposure, resolution, scan size, and send size.



The ratio cannot be specified and "Rotation Sending Setting" cannot be selected.



**To cancel Card Shot...**

Touch the [Cancel] key in the screen of step 4.



# SCANNING MANY ORIGINALS AT ONCE (Job Build)

This function lets you separate an original consisting of numerous pages into sets, scan each set using the automatic document feeder, and transmit the pages in a single transmission. Use this function when the number of originals that you wish to scan exceeds the maximum number of sheets that can be inserted in the automatic document feeder at once.

When scanning originals that are separated into sets, scan the set that has the first page first. The settings that you select for the first set can be used for all remaining sets.

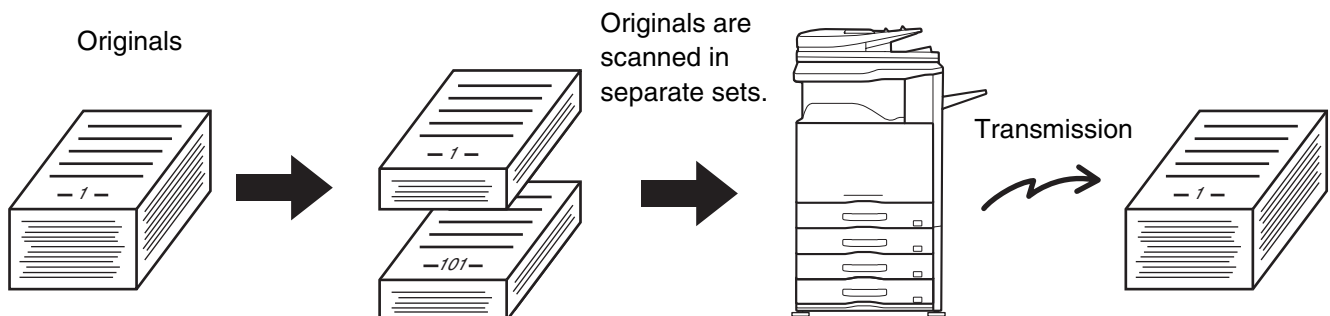

- Up to 999 pages can be scanned. Note that when the memory is being used for other jobs, fewer pages can be scanned.
- When using USB memory mode, connect the USB memory device to the machine before performing the procedure below.

1

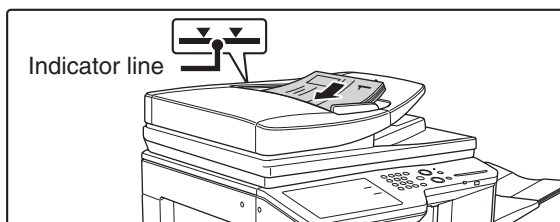

## Insert the originals face up in the document feeder tray.

Insert the originals all the way into the document feeder tray. Multiple originals can be placed in the document feeder tray. The stack of originals must not be higher than the indicator line on the tray.

2

## Specify the destination.

➤ [ENTERING DESTINATIONS](#) (page 5-18)



When scanning to USB memory, there is no need to specify the destination. Go to step 3.

3

## Select the special modes.

(1) Touch the tab of the mode that you wish to use.

(2) Touch the [Special Modes] key.

➤ [SPECIAL MODES](#) (page 5-71)

4

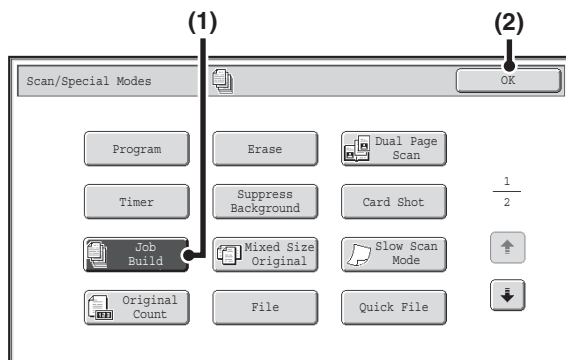

### Select job build mode.

(1) Touch the [Job Build] key so that it is highlighted.

(2) Touch the [OK] key.

5



If the destination is an Internet fax destination, press the [BLACK & WHITE START] key.



#### To cancel scanning...

Press the [STOP] key (⏹) to cancel the operation.

6

### Insert the next set of originals and press the [COLOUR START] key or the [BLACK & WHITE START] key.

Press the [START] key pressed in step 5.

Repeat until all originals have been scanned.



#### To cancel scanning...

Press the [STOP] key (⏹) to cancel the operation. All scanned data will be cleared.

7

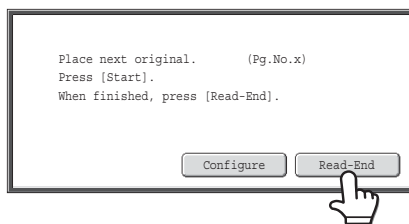

### Touch the [Read-End] key.



- If no action is taken for one minute after the confirmation screen appears, scanning automatically ends and the transmission is reserved.
- The [Configure] key can be touched to change the exposure, resolution, scan size, and send size for each original page scanned. However, when Job Build is used in combination with "2in1" in the special modes, only the exposure can be changed when scanning each even-numbered page of the original pages.



If the memory becomes full during scanning, a message will appear and the transmission will be cancelled.



#### To cancel the job build function....

Touch the [Job Build] key in the screen of step 4 so that it is not highlighted.

# SCANNING ORIGINALS OF DIFFERENT SIZES (Mixed Size Original)

This feature lets you scan originals of different sizes at the same time; for example, B4 (8-1/2" x 14") size originals mixed together with A3 (11" x 17") size originals. When scanning the originals, the machine automatically detects the size of each original.

## Originals

(B4 (8-1/2" x 14") original mixed in with A3 (11" x 17") originals)

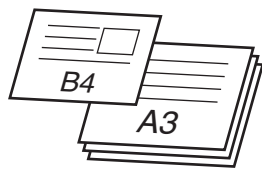

## Files created

1st page

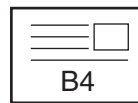

Scanned in at  
B4 (8-1/2" x 14")  
size

2nd to 4th pages

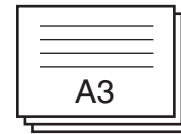

Scanned in at  
A3 (11" x 17")  
size

This feature can only be used with the following combinations of original sizes:

- A3 and B4
- A3 and B5
- B4 and A4
- A4 and B5
- A4R and B5
- B4 and A4R
- B4 and A5
- B5 and A5
- 11" x 17" and 8-1/2" x 14"
- 11" x 17" and 8-1/2" x 13"
- 11" x 17" and 5-1/2" x 8-1/2"

 When using USB memory mode, connect the USB memory device to the machine before performing the procedure below.

1

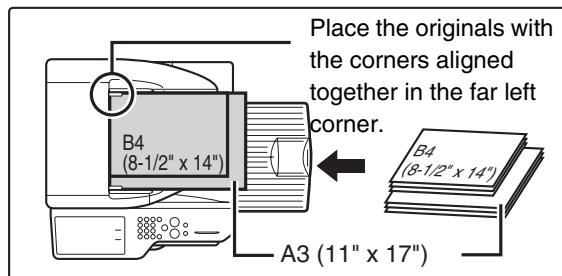

## Insert the originals face up in the document feeder tray.

Insert the originals with the corners aligned together in the far left corner of the document feeder tray.

2

## Specify the destination.

 [ENTERING DESTINATIONS](#) (page 5-18)

 When scanning to USB memory, there is no need to specify the destination. Go to step 3.

3

## Select the special modes.

(1) Touch the tab of the mode that you wish to use.

(2) Touch the [Special Modes] key.

 [SPECIAL MODES](#) (page 5-71)

4

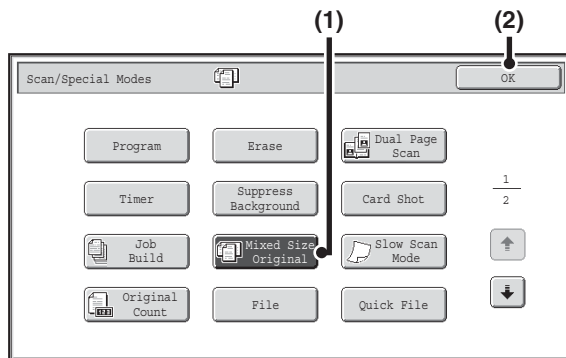

**Select the mixed size original setting.**

(1) Touch the [Mixed Size Original] key so that it is highlighted.

(2) Touch the [OK] key.



If an original scan size has been specified, a message will appear when the [Mixed Size Original] key is touched. To enable the Mixed Size Original setting, change the scan size setting to auto and then touch the [Mixed Size Original] key again.

5

**Press the [COLOUR START] key or the [BLACK & WHITE START] key.**

Scanning begins. A beep will sound to indicate that scanning is finished.



If the destination is an Internet fax destination, press the [BLACK & WHITE START] key.



**To cancel scanning...**

Press the [STOP] key (⏹) to cancel the operation.



- Once mixed size originals has been selected, an original scan size cannot be specified.
- When mixed size originals are set, automatic duplex scanning cannot be used.
- Rotate cannot be used when Mixed Size Original is enabled.



**To cancel the Mixed Size Original setting...**

Touch the [Mixed Size Original] key in the screen of step 4 so that it is not highlighted.



**System Settings (Administrator): Original Feeding Mode**

The original feeding mode can be set to always scan mixed size originals.

# SCANNING THIN ORIGINALS (Slow Scan Mode)

Use this function when you wish to scan thin originals using the automatic document feeder. This function helps prevent thin originals from misfeeding.



 When using USB memory mode, connect the USB memory device to the machine before performing the procedure below.

1

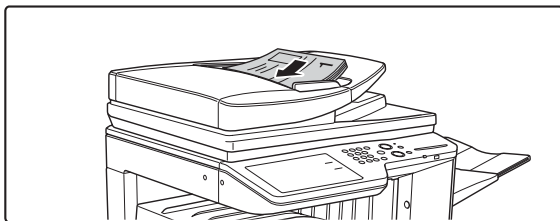

**Insert the originals face up in the document feeder tray.**

Adjust the original guides slowly.

 If the originals are inserted with too much force, they may crumple and misfeed.

2

**Specify the destination.**

 [ENTERING DESTINATIONS](#) (page 5-18)

 When scanning to USB memory, there is no need to specify the destination. Go to step 3.

3

**Select the special modes.**

(1) Touch the tab of the mode that you wish to use.

(2) Touch the [Special Modes] key.

 [SPECIAL MODES](#) (page 5-71)

4

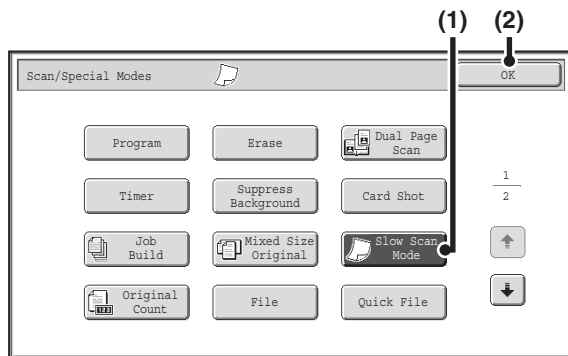
**Select slow scan mode.**

(1) Touch the [Slow Scan Mode] key so that it is highlighted.

(2) Touch the [OK] key.

5

**Press the [COLOUR START] key or the [BLACK & WHITE START] key.**

Scanning begins. A beep will sound to indicate that scanning is finished.



If the destination is an Internet fax destination, press the [BLACK & WHITE START] key.

**To cancel scanning...**

Press the [STOP] key (⏹) to cancel the operation.



- When this function is selected, automatic 2-sided scanning is not possible.
- Rotate cannot be used when Mixed Size Original is enabled.

**To cancel slow scan mode...**

Touch the [Slow Scan Mode] key in the screen of step 4 so that it is not highlighted.

**System Settings (Administrator): Original Feeding Mode**

This is used to have scanning always take place in slow scan mode.

# CHECKING THE NUMBER OF SCANNED ORIGINAL SHEETS BEFORE TRANSMISSION (Original Count)

The number of scanned original sheets can be counted and displayed before transmission. Checking the number of scanned original sheets before transmission helps prevent transmission mistakes.



- This function cannot be used in USB memory mode.
- The setting can be enabled separately for each mode.

1

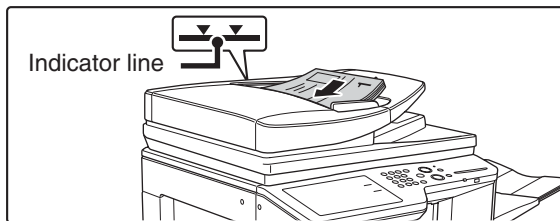

## Insert the originals face up in the document feeder tray.

Insert the originals all the way into the document feeder tray. Multiple originals can be placed in the document feeder tray. The stack of originals must not be higher than the indicator line on the tray.

2

## Specify the destination.

➤ [ENTERING DESTINATIONS](#) (page 5-18)

3

## Select the special modes.

- (1) Touch the tab of the mode that you wish to use.
- (2) Touch the [Special Modes] key.

➤ [SPECIAL MODES](#) (page 5-71)

4

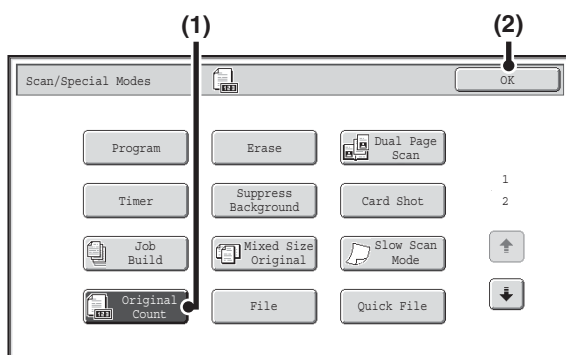

## Select the original count function.

- (1) Touch the [Original Count] key so that it is highlighted.
- (2) Touch the [OK] key.

5

## Press the [COLOUR START] key or the [BLACK & WHITE START] key.

Scanning begins.



### To cancel scanning...

Press the [STOP] key (Ⓢ) to cancel the operation. All scanned data will be cleared.

6

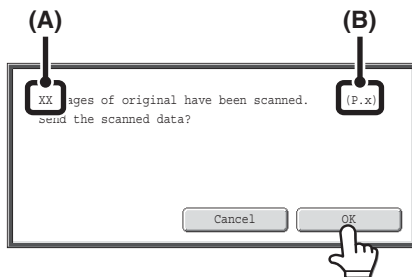

## When scanning ends, check the number of original sheets scanned and touch the [OK] key.

Transmission will begin.

- When Job Build mode is used, the confirmation message will appear after the [Read-End] key is touched.
- The message on the screen shows the number of sheets scanned in (A), and the number of pages (sheet sides) scanned in (B). For example, if both sides of one original sheet are scanned, "1" will appear in (A) and "2" will appear in (B).



If this step is not performed for one minute while the above confirmation screen appears, the scanned image and settings will be cleared and the base screen will reappear. Scanning will not be completed automatically and the image will not be reserved for transmission.



### If the displayed number of original sheets is different from the actual number of sheets...

Touch the [Cancel] key and then touch the [OK] key in the message screen to clear all scanned data. Scan settings and destination settings will not be cleared. Insert the original sheets in the automatic document feeder again and press the [START] key to re-scan.



When a broadcast transmission is performed, if the original count function is selected in any of the modes, the function will operate for all destinations.



### To cancel the Original Sheet Count function...

Touch the [Original Count] key in the screen of step 4 so that it is no longer highlighted.



### System Settings (Administrator): Initial Original Count Setting

This can be enabled to have the number of original sheets always counted. The setting can be enabled separately for each mode.



# STAMPING SCANNED ORIGINALS (Verif. Stamp)

This function stamps each original that is scanned using the automatic document feeder, allowing you to verify that all originals were correctly scanned.

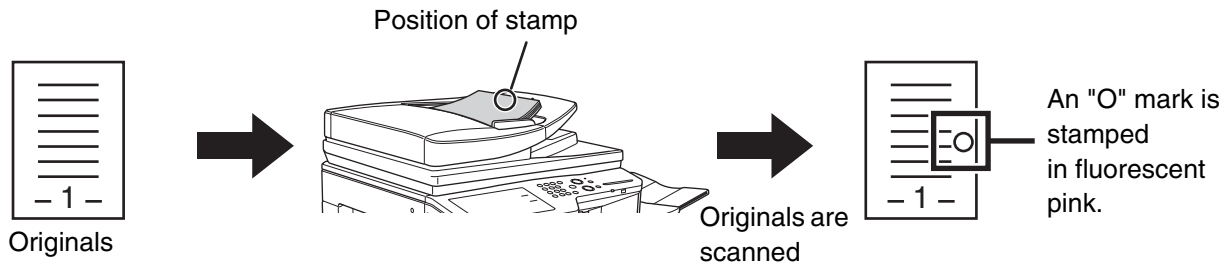

- To use this function, the stamp unit must be installed.
- When using USB memory mode, connect the USB memory device to the machine before performing the procedure below.

1

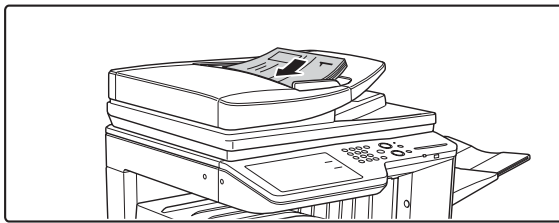

**Insert the originals face up in the document feeder tray.**

2

## Specify the destination.

☞ [ENTERING DESTINATIONS](#) (page 5-18)



When scanning to USB memory, there is no need to specify the destination. Go to step 3.

3

## Select the special modes.

(1) Touch the tab of the mode that you wish to use.



(2) Touch the [Special Modes] key.

☞ [SPECIAL MODES](#) (page 5-71)

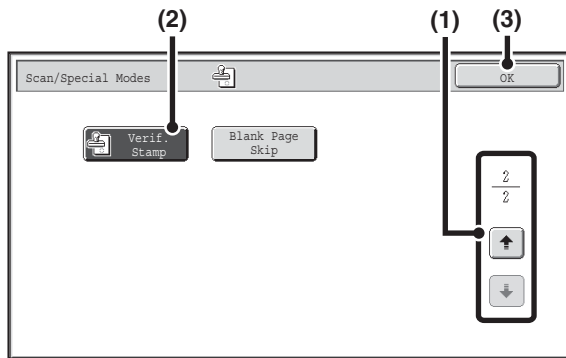
4



### Select "Verif. Stamp".

- (1) Touch the   keys to switch through the screens.
- (2) Touch the [Verif. Stamp] key so that it is highlighted.
- (3) Touch the [OK] key.

5

### Press the [COLOUR START] key or the [BLACK & WHITE START] key.

Scanning begins. A beep will sound to indicate that scanning is finished.



#### To cancel scanning...

Press the [STOP] key () to cancel the operation.



- When two-sided originals are used, the front of each original is stamped twice.
- If an error occurs during scanning, an original that was not scanned may be stamped.
- When the "O" mark that is stamped on originals starts to become faint, replace the stamp cartridge. For the procedure for replacing the stamp cartridge, see "[REPLACING THE STAMP CARTRIDGE](#)" (page 1-69) in "1. BEFORE USING THE MACHINE".



#### To cancel the stamp function...

Touch the [Verif. Stamp] key in the screen of step 4 so that it is no longer highlighted.





#### System Settings (Administrator): Default Verification Stamp

This setting is used to always have originals stamped.

# ELIMINATING BLANK PAGES FROM A TRANSMISSION (Blank Page Skip)

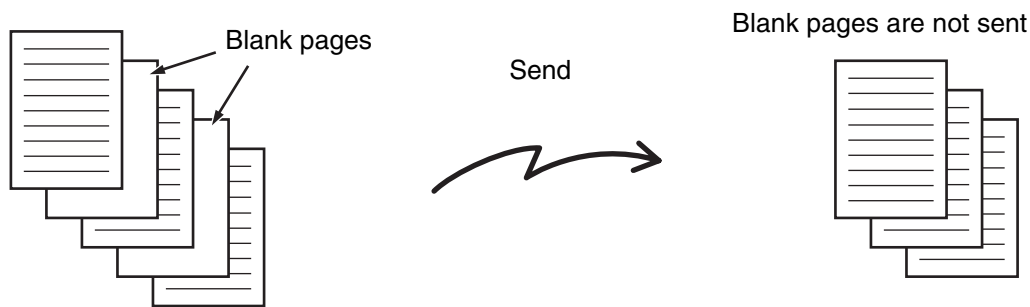
When blank pages are included in originals scanned using the automatic document feeder, the blank pages can be detected and automatically eliminated from transmission.



-  • This function cannot be used in Internet fax mode.
- Depending on the original, some pages that are not blank may be detected as blank pages and thus not sent, and some pages that are blank may not be detected as blank and thus sent.
- When using USB memory mode, connect the USB memory device to the machine before performing the procedure below.

1

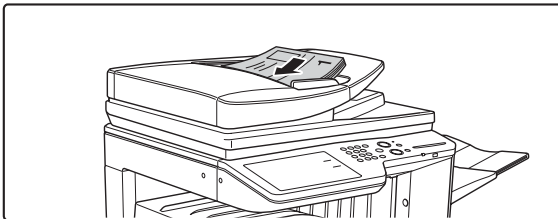

## Insert the originals face up in the document feeder tray.

This function cannot be used when the document glass is used for scan send.

2

## Specify the destination.



 [ENTERING DESTINATIONS](#) (page 5-18)



When scanning to USB memory, there is no need to specify the destination. Go to step 3.

3

## Select the special modes.

- (1) Touch the tab of the mode that you wish to use.
- (2) Touch the [Special Modes] key.
- (3) Touch the   keys to switch through the screens.
- (4) Touch the [Blank Page Skip] key.

 [SPECIAL MODES](#) (page 5-71)

4

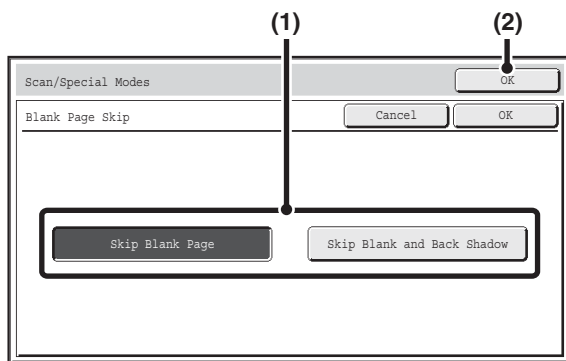

### Set blank page skipping.

#### (1) Select the type of blank page to be skipped.

Select from two types.

To include blank pages on which the content on the opposite side shows through, touch [Skip Blank and Back Shadow].

#### (2) Touch the [OK] key.

5

### Press the [COLOUR START] key or the [BLACK & WHITE START] key.

Scanning begins. A beep will sound to indicate that scanning is finished.

#### To cancel scanning...

Press the [STOP] key (⏏) to cancel the operation.

6

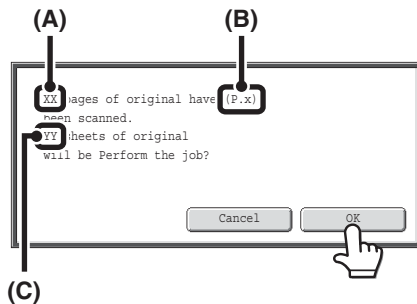

### When scanning is completed, check the number of original sheets and the number of sheets to be sent, and touch [OK].

Scanning begins.

- When Job Build mode is used, the confirmation message will appear after the [Read-End] key is touched.
- The number of scanned original sheets appears in (A), the number of scanned sides in (B), and the number of sheets to be sent excluding blank pages in (C). For example, if five original sheets that include two blank pages are scanned by duplex scanning, (A) will show "5", (B) will show "10", and (C) will show "8".



If this step is not performed for one minute while the above confirmation screen appears, the scanned image and settings will be cleared and the base screen will reappear. Scanning will not be completed automatically and the image will not be reserved for transmission.

When "Default Preview" is enabled in the system settings (administrator) and the skip blank pages function is used to scan original pages, you can check the pages, including the blank pages, in the preview screen. For more information, see "[PREVIEW CHECK SCREEN](#)" (page 5-70).

**To cancel the Blank Page Skip function...**  
Touch the [Cancel] key in the screen of step 4 so that it is no longer highlighted.

**System settings (administrator): Original Feeding Mode**  
Use this setting to always skip blank pages when sending.

# SENDING TWO PAGES AS A SINGLE PAGE (2in1)

Two original pages can be reduced to half their original size and sent together as a single page.

Portrait-oriented originals



Landscape-oriented originals



This function cannot be used in scan mode, USB memory mode, or data entry mode.

## 1 Place the original.

When placing the originals, orient them as shown below.

Originals	Document feeder tray Place the originals face up.	Document glass Place the originals face down.
Portrait orientation 		
Landscape orientation 		

1

2

## Specify the destination.

[ENTERING DESTINATIONS](#) (page 5-18)

### Select the special modes.

3

- (1) Touch the [Internet Fax] tab.
- (2) Touch the [Special Modes] key.

☞ [SPECIAL MODES](#) (page 5-71)

4

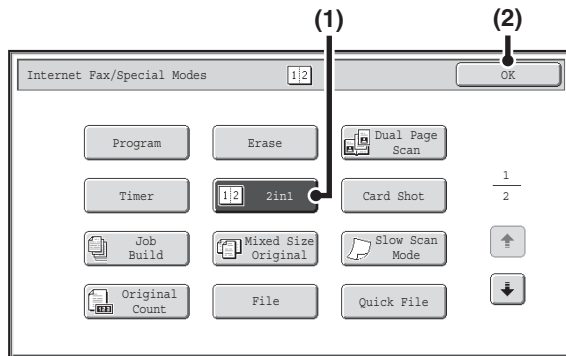

### Select 2in1.

- (1) Touch the [2in1] key so that it is highlighted.
- (2) Touch the [OK] key.

5

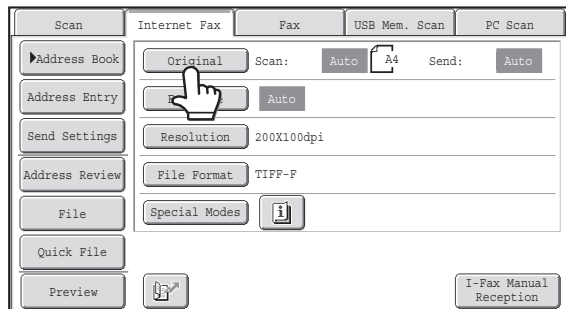

### Touch the [Original] key.

6

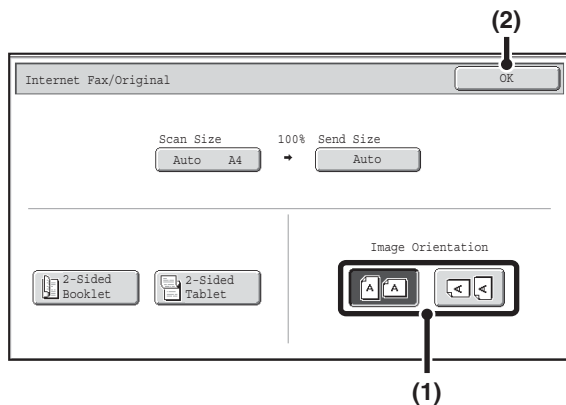

### Specify the orientation in which the original is placed.

- (1) Touch the "Image Orientation" key with the same orientation as the original image.  
If this setting is not correct, a suitable image may not be transmitted.
- (2) Touch the [OK] key.

## 7

**Press the [BLACK & WHITE START] key.**

Scanning begins.

- If you inserted the original pages in the document feeder tray, all pages are scanned.  
A beep will sound to indicate that scanning is finished.
- If you are scanning the original on the document glass, scan each page one page at a time.  
When scanning finishes, place the next original and press the [BLACK & WHITE START] key. Repeat until all pages have been scanned and then touch the [Read-End] key.  
A beep will sound to indicate that scanning is finished.



The [Configure] key can be touched in the scan-end confirmation screen to change the exposure, resolution, scan size, and send size. (However, when scanning each even-numbered page of the original, only the exposure can be changed.)

**To cancel scanning...**

Press the [STOP] key (Ⓢ) to cancel the operation.



- Transmission is not possible at a size smaller than the original size.
- The 2in1 function cannot be used when the original is other than A4, B5, or A5 (8-1/2" x 11" or 5-1/2" x 8-1/2") size.
- When the scan size of the original is specified by numerical values, this function cannot be used.

**To cancel 2in1...**

Touch the [2in1] key in the screen of step 4 so that it is not highlighted.

# CHANGING THE PRINT SETTINGS FOR THE TRANSACTION REPORT (Transaction Report)

A transaction report is automatically printed out to alert you when an Internet fax transmission fails or when a broadcast transmission is performed. The transaction report contains a description of the transmission (date, start time, name of other party, time required, number of pages, result, etc.).

 [INFORMATION APPEARING IN THE RESULT COLUMN](#) (page 5-111)



This function cannot be used in scan mode, USB memory mode, or data entry mode.

Transaction reports are printed based on conditions set in the system settings; however, you can temporarily select different conditions for a transmission. To change the transaction report print conditions at the time of transmission, follow the steps below.

## 1

### Place the original.

Place the original face up in the document feeder tray, or face down on the document glass.



## 2

### Specify the destination.

 [ENTERING DESTINATIONS](#) (page 5-18)

## 3

### Select the special modes.

- (1) Touch the [Internet Fax] tab.
- (2) Touch the [Special Modes] key.
- (3) Touch the   keys to switch through the screens.
- (4) Touch the [Transaction Report] key.

 [SPECIAL MODES](#) (page 5-71)

## 4

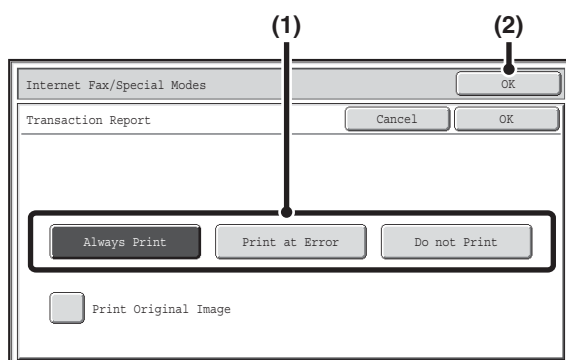

### Select print conditions.

- (1) Select the print conditions.
- (2) Touch the [OK] key.



- The print conditions for a transaction report are as follows:
  - "Always Print": A transaction report is printed no matter whether the transmission succeeds or fails.
  - "Print at Error": A transaction report is printed when transmission fails.
  - "Do not Print": Do not print a transaction report.
- When the [Print Original Image] checkbox is selected , part of the transmitted original is included on the transaction report.



5

**Press the [BLACK & WHITE START] key.**

Scanning begins.

- If you inserted the original pages in the document feeder tray, all pages are scanned.  
A beep will sound to indicate that scanning is finished.
- If you are scanning the original on the document glass, scan each page one page at a time.  
When scanning finishes, place the next original and press the [BLACK & WHITE START] key. Repeat until all pages have been scanned and then touch the [Read-End] key.  
A beep will sound to indicate that scanning is finished.

**To cancel scanning...**

Press the [STOP] key (Ⓢ) to cancel the operation.



For a broadcast transmission, changes to the transaction report print conditions apply to all destinations.

**To cancel the transaction report setting...**

Touch the [Cancel] key in the screen of step 4.



- **System Settings (Administrator): Transaction Report Print Select Setting**

This is used to set the conditions for printing transaction reports.

The factory default setting is .Single Sending: Print Out All Report//No Printed ReportBroadcasting: /Print Out Error Report Only/No Printed ReportReceiving: Print Out All Report/Print Out Error Report Only/

- **System Settings (Administrator): Original Print on Transaction Report**

This is used to have part of the transmitted original printed on the transaction report.

# CHECKING THE STATUS OF TRANSMISSION/RECEPTION JOBS

This section explains how to check the status of reserved transmission jobs and received Internet faxes.

## JOB STATUS SCREEN

The job status screen is displayed when the [JOB STATUS] key (⌂) on the touch panel is touched. The job status screen shows the status of jobs by mode. When the [JOB STATUS] key (⌂) is touched, the job status screen of the mode that was being used before the key was pressed appears.

Reserved transmissions and received Internet faxes are referred to as jobs here.

### Example: Pressing the tab in scan mode

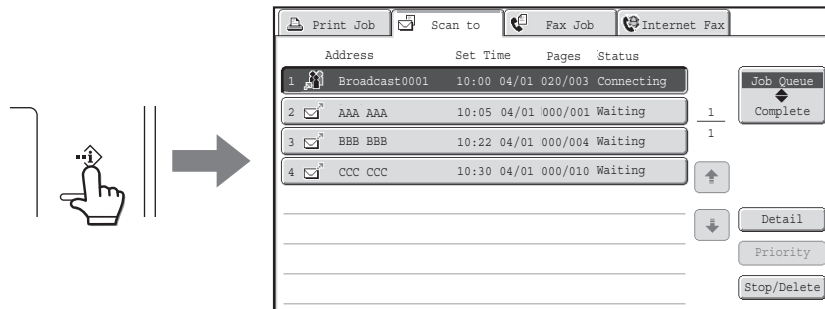

The job status display is in the lower left corner of the touch panel. The job status display can be touched to display the job status screen.

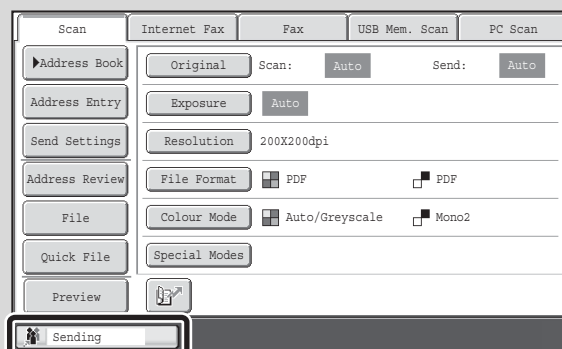

# JOB QUEUE SCREEN AND COMPLETED JOB SCREEN

The job status screen consists of two screens: the job queue screen that shows reserved jobs and the job currently in progress, and the completed jobs screen. To switch between the two screens, touch the job status screen selector key ((2) below).

## Job queue screen

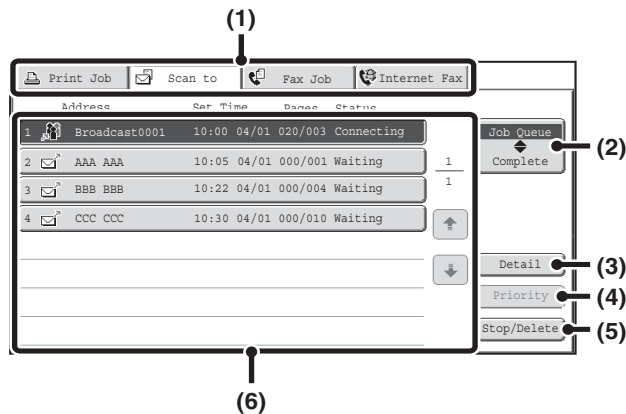

## Complete screen

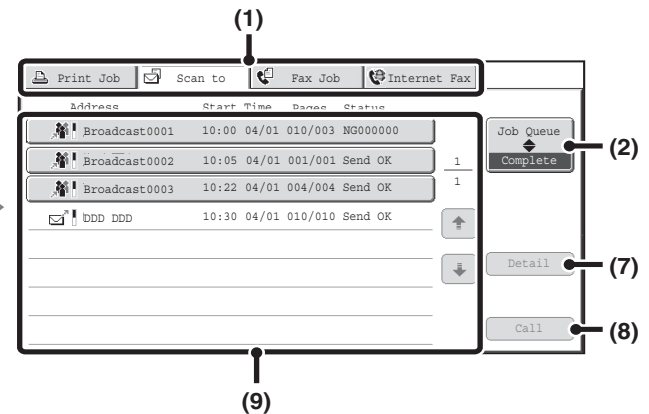

### (1) Mode switch tabs

Use these tabs to change the job status screen mode.

### (2) Job status screen selector key

Touch this key to switch between the job queue screen and the completed jobs screen.

### (3) Job queue screen [Detail] key

This shows detailed information on broadcast transmission jobs and the status of jobs. Select the key of the desired job in the job queue screen (6) and then touch the [Detail] key.

### (4) [Priority] key

Touch this key to give priority to a selected job.

☞ [GIVING PRIORITY TO A SCAN TRANSMISSION JOB](#) (page 5-110)

### (5) [Stop/Delete] key

Touch this key to stop or delete a selected job.

☞ [STOPPING A SCAN JOB BEING TRANSMITTED OR WAITING TO BE TRANSMITTED](#) (page 5-109)

### (6) Job queue screen

Jobs are shown as keys in the order they were reserved. Each key shows information on the job and its current status.

☞ [Job key display](#) (page 5-105)

### (7) Completed jobs screen [Detail] key

This shows detailed information on the results of completed broadcast transmissions and jobs that used the document filing function. Select the key of the desired job in the completed jobs screen (9) and then touch the [Detail] key.

This key does not appear if the hard disk drive is not installed.

☞ [CHECKING COMPLETED JOBS](#) (page 5-108)

### (8) [Call] key

Touch this key to call up and use a transmission or reception job stored with the document filing function. This key does not appear if the hard disk drive is not installed.

### (9) Completed jobs screen

This shows up to 99 completed transmission or reception jobs in each mode. A description of the job and the result (status) are shown.

Jobs that used document filing function, broadcast transmission jobs, and received Internet fax forwarding jobs are indicated as keys.

## Job key display

The following information is shown in the job queue keys and completed job keys that appear in the job status screen. Direct SMTP information is also included in Internet fax transmission/reception information.

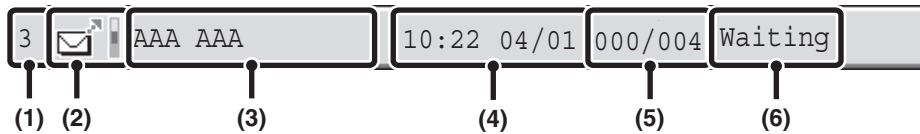

**(1) Displays the number (position) of the job in the job queue.**

When the job currently being transmitted is finished, the job moves up one position in the job queue. This number does not appear in keys in the completed jobs screen.

**(2) Mode icon**

This indicates the type of job. In the completed jobs screen, a colour bar appears next to the icon to indicate whether the job was executed in colour or black & white. (However, the colour bar icon does not appear in the key of a job that used document filing or in the key of a transmission/reception job that was cancelled.)

Icon	Job type
	Scan to E-mail
	Scan to FTP
	Scan to Network Folder
	Scan to Desktop
	Internet fax transmission
	Internet fax reception
	PC-I-Fax transmission
	Broadcast transmission or Inbound routing
	Metadata transmission

**(3) Name of communicating party (address)**

For a transmission, the name or address of the destination. For a reception, the address of the sending party. In the case of a broadcast transmission, "Broadcast" appears together with a broadcast control number (4-digits).

**(4) Time reserved/Time started**

In the job queue screen, the date and time the job was reserved. In the completed jobs screen, the date and time the job was started.

**(5) Number of pages**

Shows the number of pages transmitted/total number of original pages.

**(6) Status**

Shows the job status.

- Job in progress

Display	Status
"Connecting"	Connecting to the destination.
"Sending"	Sending data.
"Receiving"	Receiving an Internet fax.
"Stopped"	The job has been stopped.
"Error"	An error occurred while the job was being executed.

- Job waiting to be executed

Display	Status
"Waiting"	The job is waiting to be executed.
"Retry Mode"	The job is being re-attempted due to a communication error or other problem.
"Report Wait"	An Internet fax has been sent for which a receive report was requested, and the machine is waiting for the receive report.
A day and time is displayed	Timer transmission job (the specified time is displayed)

- Completed job

Display	Status
"Send OK"	Transmission was completed.
"In Memory"	An Internet fax has been received but has not yet been printed.
"Received"	Printed received fax data.
"Forward OK"	A received Internet fax has been forwarded.
"Stopped"	The job was stopped.
"Delete"	Deleted received data in the image check screen.
"Number of successful transmission destinations/ Total destinations OK"	Completion of a broadcast transmission or inbound routing operation. If transmission to 3 destinations was successful out of a total of 5, "003/005 OK" will appear.
"No Response"	An error occurred because there was no response from the destination.
"OK Report"	A receive report was requested for a transmission, the transmission was completed normally, and the receive report was received from the destination.
"NG Report"	A receive report was requested for a transmission, however, the transmission did not take place correctly and a transmission failed report was received.
"No Report"	An e-mail was received without an attached file and thus printing was not possible.
"Received"	An e-mail was received, however, the attached file was not a TIFF-F file or there was no attached file, and thus printing was not possible.
"Rejected"	An Internet fax was sent from a party that is blocked.
"NGxxxxxx"	Transmission/reception was not successful because a communication error occurred (a 6-digit error code appears in xxxxxx.)
"Error"	An error occurred while the job was being executed.

# OPERATION WHEN A JOB IN THE JOB QUEUE IS COMPLETED

When a normal transmission job is completed, it moves to the completed jobs screen and "Send OK" appears in the status column.

Received Internet faxes, timer transmission jobs, and forwarding jobs are handled in the job status screen as explained below.

## Internet fax reception jobs

While an Internet fax is being received, "Receiving" appears.

When reception is completed, the job moves to the completed jobs screen and "In Memory" appears.

When printing ends, the status changes to "Printed" and the job is completed.

## Timer transmission jobs

A timer transmission job appears at the bottom of the job queue until the specified time arrives.

When the specified time arrives, the job is executed. If another job is in progress, the timer job is started when the other job is completed.

## Internet fax transmission jobs that request a receive report

After completion of an Internet fax transmission job (excluding Direct SMTP transmission jobs) that requests a receive report, the job is placed on standby at the bottom of the job queue screen. "Report Wait" appears in the status column.

When the receive report is received from the destination, or if the report is not received within the timeout time, the job moves to the completed jobs screen.

## Reception jobs when "Inbound Routing Settings" are enabled

When "Inbound Routing Settings" are enabled, reception jobs are handled as follows depending on the print setting.

☞ [FORWARDING RECEIVED INTERNET FAXES TO AN ADDRESS \(Inbound Routing Settings\)](#) (page 5-119)

- **Received Internet fax is not printed**

"Receiving" appears while the Internet fax is being received. When reception is completed, the job moves to the job queue of the job status screen of scan mode.

- **Received Internet fax is printed**

When reception is completed, the job moves to the completed jobs screen and "In Memory" appears. When printing ends, the status changes to "Printed" and the job is completed. In addition, the job is added to the job queue of the job status screen of scan mode. When forwarding received Internet faxes is finished, "Forward OK" appears.

## CHECKING COMPLETED JOBS

(On the MX-2314N, the productivity kit is required.)

You can check a list of the destinations, the destinations for which transmission failed, and other detailed information on completed jobs that used document filing function, broadcast transmission jobs, and received Internet fax forwarding jobs. Touch the key of the job for which you wish to display information in the completed jobs screen and touch the [Detail] key. The job detail screen (see below) will appear.

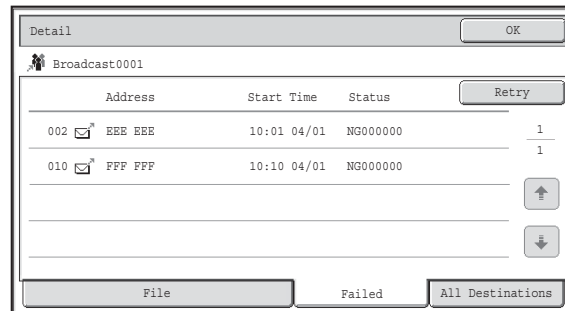

The job name appears at the top of the job detail screen.

To view details on the job, touch one of the tabs. The following information appears on each tab.

Tab name	Information displayed
File	Shows information on a transmission/reception that used document filing function. To call up the file and use it, touch the [Call] key.
Failed	Shows information on addresses for which communication failed. Address: Address name or number Start time: Time at which communication began. Status: Description of failure (error) The [Retry] key can be touched to re-attempt transmission to that address.*
All Destinations	Shows all addresses specified in the job. Address: Address name or number Start time: Time at which communication began. Status: Communication result The [Retry] key can be touched to transmit to all addresses again.*

\* Recalling is not possible for a broadcast transmission that includes a Scan to FTP address, Scan to Network Folder address, or Scan to Desktop address.

# STOPPING A SCAN JOB BEING TRANSMITTED OR WAITING TO BE TRANSMITTED

Follow the steps below to stop a job that is being transmitted or is waiting to be transmitted.

1

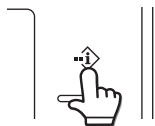

Touch the [JOB STATUS] key (  ).

2

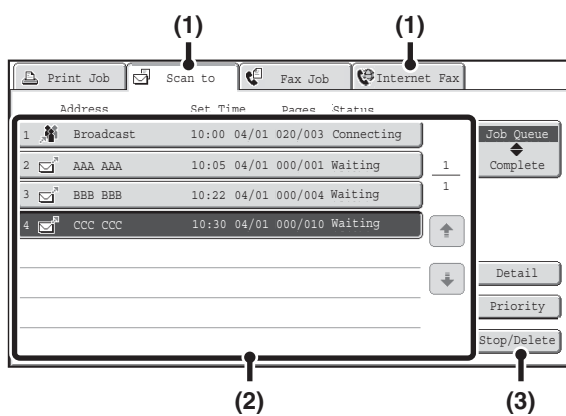

Select the job that you wish to stop.

- (1) Touch the mode tab of the job to be stopped.
- (2) Touch the key of the job to be stopped.
- (3) Touch the [Stop/Delete] key.

3

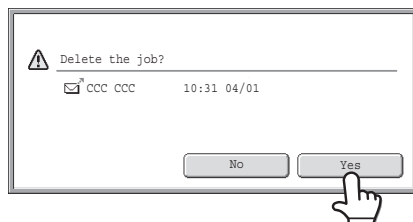

Touch the [Yes] key.



**If you do not want to stop the selected job...**

Touch the [No] key.



Printing of a received Internet fax cannot be stopped.



# GIVING PRIORITY TO A SCAN TRANSMISSION JOB

When multiple jobs are waiting to be transmitted, the jobs are normally transmitted in the order they were reserved. If you need to give priority to a job and send it ahead of the other jobs, follow the steps below.

1

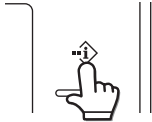

Touch the [JOB STATUS] key ( ⓘ ).

2

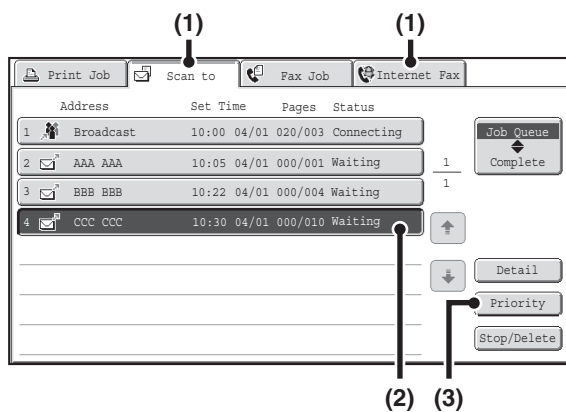

Select the job to which you wish to give priority.

- (1) Touch the mode tab of the job to be given priority.
- (2) Touch the key of the job to be given priority.
- (3) Touch the [Priority] key.

The selected job moves up to the position immediately following the job in progress. The job will be executed when the job in progress is completed.

# CHECKING THE INTERNET FAX ACTIVITY LOG (Image Sending Activity Report)

## IMAGE SENDING ACTIVITY REPORT

You can have the machine print a log of recent image sending activity (date, name of other party, time required, result, etc.). The Image Sending Activity Report contains useful information such as the types of errors that occurred.

The most recent 200 transactions are included in the report.

You can have the machine print the Image Sending Activity Report each time the number of transactions reaches 201, or at a specified time (once a day only).

 The contents of the Image Sending Activity Report are erased when the report is printed, and thus it cannot be reprinted.

 **System Settings (Administrator): Activity Report Print Select Setting**  
This is used to set the conditions for printing activity reports. The factory default setting is not to print. The Image Sending Activity Report can be set to print each time the number of transactions reaches 201, or at a specified time (once a day only).

## INFORMATION APPEARING IN THE RESULT COLUMN

Error types and other information are printed in the result column of transaction and activity reports. When a transaction report or activity report is printed, check the result of the transaction in the result column and take action as needed.

### Examples of messages that are printed in the result column

Message	Explanation
OK	The transaction was completed normally.
OK REPORT	A receive report was requested for a transmission, the transmission was completed normally, and the receive report was received from the destination.
CANCEL	A transmission was stopped while in progress, or a reserved transmission job was cancelled.
MEM. FULL	The memory became full during reception.
REJECTED	An Internet fax was sent from a party that is blocked.
NG REPORT	A receive report was requested for a transmission, however, the transmission did not take place correctly and a transmission failed report was received.
NO REPORT	A receive report was requested for a transmission, however, a report was not received within the timeout time.
NG LIMIT	Transmission was not possible because the file size exceeded the machine's file size limit setting.
RECEIVED	An e-mail was received, however, the attached file was not a TIFF-F file or there was no attached file, and thus printing was not possible.
FAIL xx (xxxx)	The transaction failed due to a communication error. First 2 digits of communication error number: Error code from 00 to 99. Last 4 digits of communication error number: Code for use by service technicians.

# INTERNET FAX RECEPTION FUNCTIONS

This section explains the basic procedures for receiving Internet faxes.

## RECEIVING AN INTERNET FAX

The Internet fax function periodically\* connects to the mail server (POP3 server) and checks whether or not Internet faxes have been received. When faxes have been received, the faxes are automatically retrieved and printed.

\* The default setting is once every 5 minutes.



If faxes will be received at night, keep the main power switch in the "on" position.

1

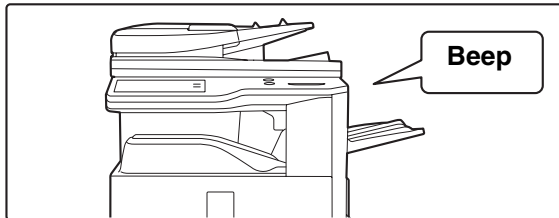

**Internet faxes are received automatically.**

A beep sounds when reception ends.

2

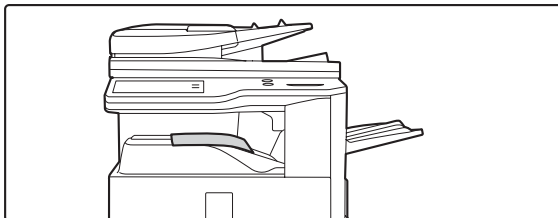

**The faxes are printed automatically.**



If the machine is out of paper or there is no paper that matches the size of the received fax, a message will appear in the touch panel. Follow the instructions in the message to load an appropriate size of paper.



- **System Settings: Fax Data Receive/Forward (page 7-22)**

When printing is not possible because the machine has run out of paper or toner, received Internet faxes can be forwarded to and printed by another previously stored Internet fax machine.

- **System Settings (Administrator): I-Fax Default Settings**

These settings are used to select how received faxes are handled when the [POWER] key (⏻) is "off" (the main power switch is "on"), the volume of the beep that sounds when reception ends, and whether or not received e-mail messages are printed.

- **System Settings (Administrator): I-Fax Receive Settings**

Settings related to Internet fax reception can be configured such as the interval for checking for received faxes, duplex reception, output settings, auto reduction printing, and storing allow/reject reception addresses.

- **System Settings (Administrator): Allow/Reject Mail or Domain Name Setting**

This setting is used to allow/refuse reception from stored addresses and domains.

- **System Settings (Administrator): Receiving Date & Time Print**

Use this to select whether or not the date and time of reception is added when a received image is printed.

# MANUALLY RECEIVING INTERNET FAXES

If the interval for checking for received faxes is somewhat long and you wish to check immediately, you can manually initiate reception.

Touch the [I-Fax Manual Reception] key to connect to the mail server and retrieve received faxes.

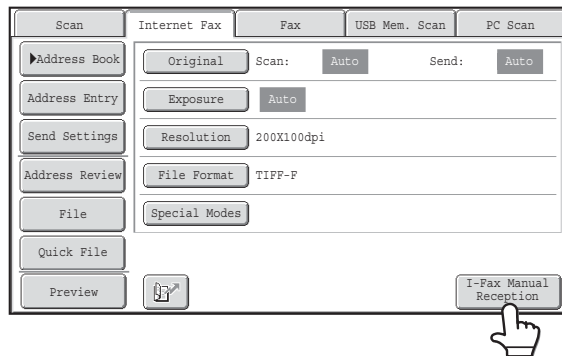

 If POP3 server settings are not configured in the Web pages, the [I-Fax Manual Reception] key is greyed out to prevent selection.

 **System Settings: Fax Data Receive/Forward (page 7-22)**  
This setting is used to hide the [I-Fax Manual Reception] key that appears in the base screen of Internet Fax mode. When the [I-Fax Manual Reception] key is hidden, manual reception is initiated by touching the [Reception Start] key in the screen that appears when "Fax Data Receive/Forward" - "I-Fax Settings" is selected.

# PRINTING A PASSWORD-PROTECTED FAX (Hold Setting For Received Data Print)

"Hold Setting for Received Data Print" in the system settings (administrator) can be enabled to have faxes received to memory without being printed. To print the faxes, a password must be entered. When this function is enabled, a password entry screen appears in the touch panel when received Internet faxes are retrieved.

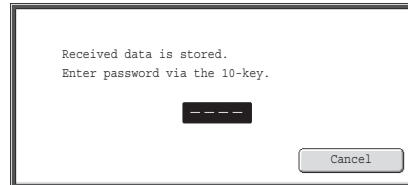

When the previously programmed 4-digit password is entered with the numeric keys, printing begins. The [Cancel] key can be touched to close the password entry screen; however, the data in memory key (📄) will blink in the touch panel. The password entry screen will reappear when you touch the blinking key (📄) or change modes. When "Received Data Image Check Setting" is enabled in the system settings (administrator), a password can be entered to display the received data list screen. If you wish to check an image before printing it, continue from step 2 on the next page.



- The received faxes will be retained in memory regardless of whether they were received automatically or manually.
- If "Fax Data Receive/Forward" is enabled in the system settings so that received faxes are forwarded to another machine, faxes retained in memory are also forwarded. At that time, the same password entry screen will appear as for printing. Forwarding will not take place unless the password is entered.



#### **System Settings (Administrator): Hold Setting for Received Data Print**

Enable this setting to have faxes received to memory without being printed. This setting is also used to program the password that must be entered to print the faxes.

# CHECKING THE IMAGE BEFORE PRINTING

(On the MX-2314N, the productivity kit is required.)

When "Received Data Image Check Setting" is enabled\* in the system settings (administrator), you can check a received image in the touch panel before printing it out. When this function is enabled, follow the steps below to print a received image.

\* The factory default setting is disabled.

 Depending on the size of the received data, part of the image in the image check screen on the touch panel may not appear.

1

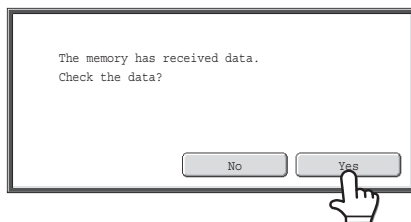

**When an image is received, a confirmation prompt will appear. Touch the [Yes] key.**

If this message appears while you are configuring settings of any type and you touch the [Yes] key, the settings that you are configuring will be cancelled. If this message appears in another mode, you will return to the base screen of image send mode after checking the image.

2

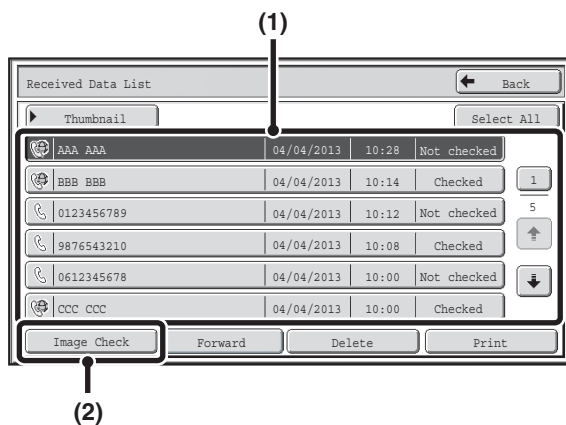

**Select the received image**

**(1) Touch the key of the received image that you want to check.**

Multiple received images can be checked.

**(2) Touch the [Image Check] key.**

- To show thumbnails of the received images, touch the [Thumbnail] key.
- To delete an image that has been selected, touch the [Delete] key. To print an image that has been selected, touch the [Print] key.

3

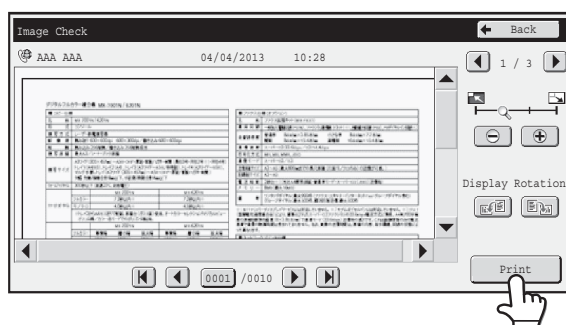

**Check the received image and then touch the [Print] key.**

Printing begins.

For information on the image check screen, see "[IMAGE CHECK SCREEN](#)" (page 5-118).

 If the screen of step 1 appears when you are configuring settings in the setting screens of any of the modes, the configured settings will be cancelled if you view the image. After viewing the image, you will return to the base screen of image send mode, regardless of which mode you were in previously.

 **System Settings (Administrator): Received Data Image Check Setting**  
Use this to specify whether or not a received Internet fax can be viewed before it is printed.

# CHECKING THE IMAGE BEFORE FORWARDING

(On the MX-2314N, the productivity kit is required.)

When "Received Data Image Check Setting" is enabled in the system settings (administrator), you can select the received data from the list and forward it to the addresses recorded in the address book. When this function is enabled, follow the steps below to forward the received image.

\* The factory default setting is disabled.

 Depending on the size of the received data, part of the image in the image check screen on the touch panel may not appear.

1

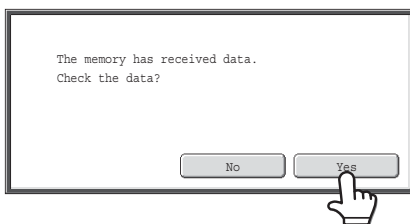

**When an image is received, a confirmation prompt will appear. Touch the [Yes] key.**

If this message appears while you are configuring settings of any type and you touch the [Yes] key, the settings that you are configuring will be cancelled. If this message appears in another mode, you will return to the base screen of image send mode after checking the image.

2

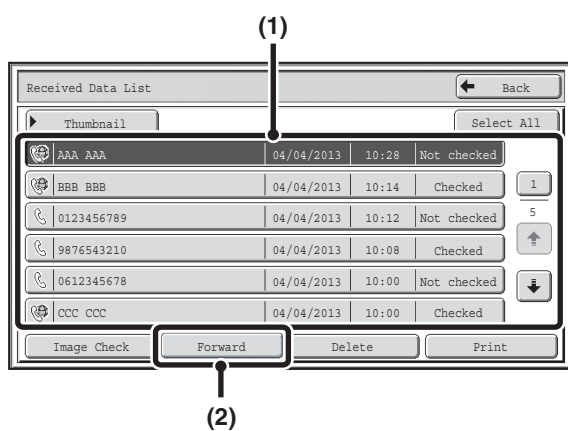

**Select the received image**

**(1) Touch the key of the received image that you want to check.**

Multiple received images can be checked.

**(2) Touch the [Forward] key.**

- To show thumbnails of the received images, touch the [Thumbnail] key.
- The received image can be checked by touching the [Image Check] key.

 [IMAGE CHECK SCREEN](#) (Page 5-118)

3

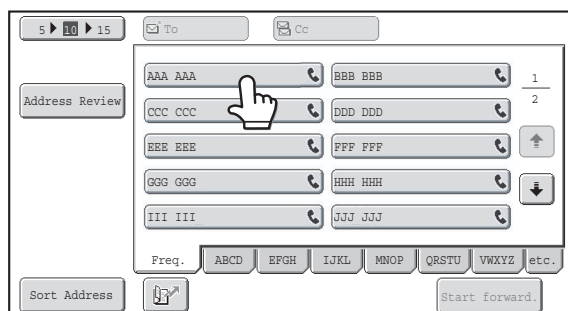

**Touch the Forward Destination from the address book to select it.**

Multiple forwarding addresses can be checked.

4

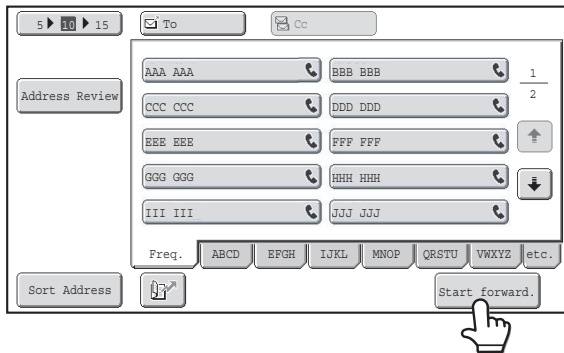

## Start forward

Touch the [Start forward.] key.



If the screen of step 1 appears when you are configuring settings in the setting screens of any of the modes, the configured settings will be cancelled if you view the image. After viewing the image, you will return to the base screen of image send mode, regardless of which mode you were in previously.



### System Settings (Administrator): Received Data Image Check Setting

Use this to specify whether or not a received Internet fax can be viewed before it is printed.



# IMAGE CHECK SCREEN

(On the MX-2314N, the productivity kit is required.)  
This section explains the image check screen.

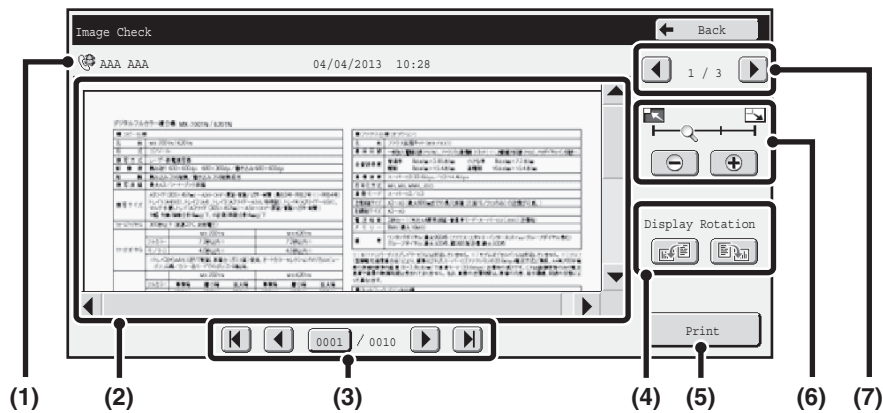

## (1) Information display

This shows information on the displayed image.

## (2) Preview image

An image of the selected received image appears.  
If the image is cut off, use the scroll bars at the right and bottom of the screen to scroll the image. Touch a bar and slide it to scroll. (You can also touch the keys to scroll.)

## (3) Change page keys

When there are multiple pages, use these keys to change pages.

- keys: Go to the first or the last page.
- keys: Go to the previous page or the next page.
- Page number display: This shows the total number of pages and the current page number. You can touch the current page number key and enter a number with the numeric keys to go to that page number.

## (4) "Display Rotation" key

This rotates the image right or left by 90 degrees. The rotation applies to all pages in the file, not just the displayed page.

## (5) [Print] key

Touch to start printing.

## (6) Display zoom key

Use this to set the zoom ratio of the displayed image. Changes from the left in the order "Full Page", "Twice", "4 Times", "8 Times". The setting applies to all pages in the file, not just the displayed page.

## (7) Image select key

When multiple images are selected for preview display, use this to change the displayed images.





A preview image is an image for display on the touch panel. It will differ from the actual print result.

# FORWARDING RECEIVED INTERNET FAXES TO AN ADDRESS (Inbound Routing Settings)

(On the MX-2314N, the productivity kit is required.)

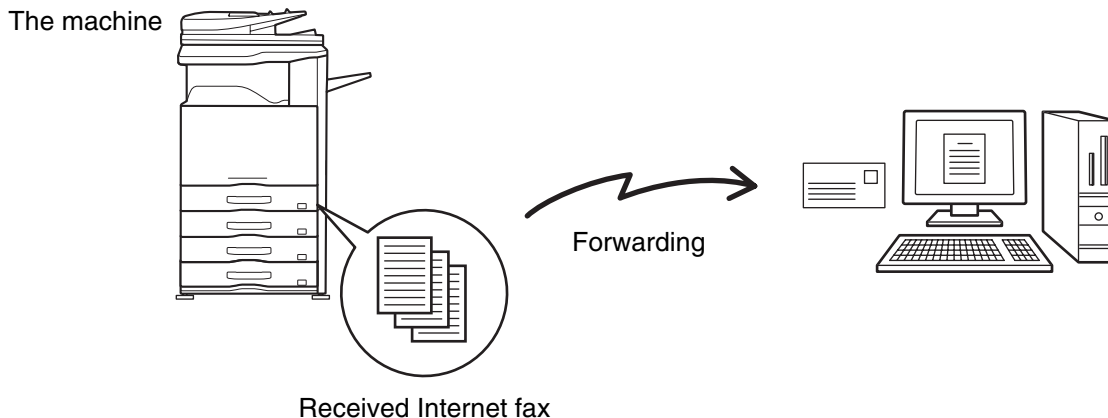
Received Internet faxes can be automatically forwarded to a facsimile internet fax, e-mail address, file server address, desktop address, or network folder address. When this function is enabled, you can also have received Internet faxes forwarded without printing them.



 When faxes forwarded using this function are printed at the forwarding destination, the date and time of reception cannot be printed on the faxes. ("Receiving Date & Time Print" is disabled.)

## CONFIGURING INBOUND ROUTING SETTINGS

All inbound routing settings are configured in the Web pages. For the procedure for accessing the Web pages, see the Start Guide.

The following explanation assumes that the Web pages have been accessed with administrator rights.

To configure inbound routing settings, follow the steps below.

**1**

Administration Settings Help(?)

**Inbound Routing Settings**

Inbound Routing:  ▾

Disable Registration of Forward Table

Disable Change/Delete of Forward Table

Disable Change of Forward Approval

Print Style Setting:

Always Print

Print at Error

Not Print and Forward to the Following E-mail Address at Error

E-mail Address:

Direct Entry (Up to 64 characters)

Select Address (From Address Book)

Notice: Address configured as forward address cannot be deleted from the address book.

### Enabling the inbound routing function.

- (1) In the Web page menu, click [Application Settings], [Inbound Routing Settings], and then [Administration Settings].
- (2) Select [Enable] in "Inbound Routing" and click the [Submit] button.

 Users without administrator rights can be prohibited from storing, editing, and deleting forwarding tables in this screen, and from specifying which table is used. To do so, select the checkboxes below .

- Disable Registration of Forward Table
  - Disable Change/Delete of Forward Table
  - Disable Change of Forward Approval
- When inbound routing is enabled, you can also specify whether or not you wish the machine to print the forwarded faxes. To have all received faxes printed before being forwarded, select "Print Out All Report" in "Print Style Setting". To have received faxes printed only when an error prevents forwarding, select "Print at Error".
- If an error occurs when [Not Print and Forward to the Following E-mail Address at Error] is selected, received data is not printed, but is forwarded to the specified e-mail address.
- After configuring the settings, be sure to click the [Submit] button.

## Storing sender addresses.

If you wish to have only faxes from specified addresses forwarded, store the desired sender addresses. Send addresses stored here can be selected from a list when you store a forwarding table.

- (1) Click **[Sender Number/Address Registration]** in the **[Inbound Routing Settings]** menu in the Web page.
- (2) Enter the sender address in **"Internet Fax Address"** or **"Fax Number"** as appropriate, and click the **[Add to List]** button.

The entered address will be added to the "Address to be Entered" list.

- Specify whether the address will be directly entered (maximum of 1500 characters) or selected from a global address book by clicking the **[Global Address Search]** button.
- To store multiple addresses, repeat this step.

- (3) When you have finished adding addresses, click the **[Submit]** button.



- A maximum of 500 sender numbers/addresses can be stored.
- To delete an entered address, select the address in "Address to be Entered" and click the **[Delete]** button.

**3**

The screenshot shows the 'Table Registration' web page. It includes a 'Table Name' field, 'Receive Line Select' (Internet Fax, Fax), and 'Sender Number/Address Setting' section with a list of senders and an 'Add(Y)' button. Below is the 'Forward Destination 1' section with 'Forward Condition' (Not Forward, Always Forward, Forward on Selected Day & Time), 'Day of the Week' checkboxes, 'Set Forwarding Time' options, and a 'Format' dropdown set to 'TIFF(Multi)'. At the bottom is a 'Forward Destination Settings' table and a 'Forward Destination' table with columns for Name, Type, Address, and No. The 'Forward Destination' table contains four entries: User A (Internet Fax, tanaka@aaa.bbb.ccc.ddd, 2), User B (Mail, suzuk@aaa.bbb.ccc.ddd, 3), User C (Network Folder, \aaaa\bbbb, 4), and User D (File, 10.20.30.40, 5). A 'Submit(U)' button is at the bottom left.

## Store a forwarding table.

Follow the steps below to store a forwarding table that combines a specified sender and forwarding address.

(1) Click [Inbound Routing Settings] in the Web page menu and click the [Add] button.

(2) Enter a "Table Name".

(3) Select the line used for reception.

(4) Select the sender whose faxes will be forwarded.

- To forward all received faxes, select [Forward All Received Data].

- To forward only data received from specific senders, select [Forward Received Data from Below Sender]. To forward all data except data from specific senders, select [Forward Received Data from Senders except Below]. Select the appropriate senders from the list and click the [Add] button.

(5) Select the forwarding address.

- To always forward received data, select [Always Forward].

- To specify a day and time on which received data will be forwarded, select [Forward on Selected Day & Time] and select the checkbox () of the desired day of the week. To specify a time, select the [Set Forwarding Time] checkbox () and specify the time.

(6) Select the file format.

The format can be set separately for each forwarding address (for each of forwarding addresses 1, 2, and 3 in the table).

(7) Select the forwarding address.

Forwarding addresses can be selected from the machine's address book. (Multiple addresses can be selected.) A maximum of 1000 forwarding addresses can be stored (a combined maximum of 100 facsimile, internet fax, file server, desktop, and network folder addresses can be stored).

(8) Click [Submit].



- When selecting senders from the "Sender Number/Address Setting" list, you can use the [Shift] key or the [Ctrl] key on your keyboard to select multiple senders.
- A maximum of 50 forwarding tables can be stored.
- Images sent in TIFF format may not display correctly in some recipient environments. In this event, change the file format to PDF.
- Up to three forwarding day and time settings can be set for one forwarding table, and a forwarding destination can be set for each set time. To configure these settings, use the forwarding list tabs to access each setting.

(2)

**Inbound Routing Settings** Login(P) Help(I)

Submit(U) Update(R)

Inbound Routing Settings: Enable  
Display Items: 10

Table Name	Forward Condition
<input type="checkbox"/> Table 1	Forward Destination 1 <input type="radio"/> Not Forward <input type="radio"/> Always Forward <input type="radio"/> Forward on Selected Day & Time
	Forward Destination 2 <input type="radio"/> Not Forward <input type="radio"/> Always Forward
	Forward Destination 3 <input type="radio"/> Not Forward <input type="radio"/> Always Forward
<input type="checkbox"/> Table 2	Forward Destination 1 <input type="radio"/> Not Forward <input type="radio"/> Always Forward <input type="radio"/> Forward on Selected Day & Time
	Forward Destination 2 <input type="radio"/> Not Forward <input type="radio"/> Always Forward
<input type="checkbox"/> Table 3	Forward Destination 1 <input type="radio"/> Not Forward <input type="radio"/> Always Forward <input type="radio"/> Forward on Selected Day & Time
	Forward Destination 2 <input type="radio"/> Not Forward <input type="radio"/> Always Forward
	Forward Destination 3 <input type="radio"/> Not Forward <input type="radio"/> Always Forward

Total Table: 3  
Previous(M) 1/1 Next(N)  
Select All(S) Clear Checked(Z)

Delete(O) Add(Y)

Back to the Top on This Page

Submit(U) Update(R)

(3)

## Specifying forwarding tables to be used.

To use the inbound routing function, enable the forwarding tables that you wish to use from among the stored tables.

(1) Click [Inbound Routing Settings] in the Web page menu.

(2) Select [Always Forward] or [Forward on Selected Day & Time] from the forwarding table.

The forwarding permission settings that appear here are linked to the forwarding conditions set in step 3. If you wish to use different forwarding conditions than those set in step 3, set the forwarding permission settings.

(3) Click [Submit].



To delete a forwarding table, click the checkbox next to the table name so that it is selected  and click [Delete].

# SCANNING FROM A COMPUTER (PC Scan Mode)

(On the MX-2314N, the productivity kit is required.)

## BASIC SCANNING PROCEDURE

You can install the scanner driver on your computer from the CD-ROM that accompanies the machine, and use a TWAIN\* compliant application to scan an image using your computer.

Scanning from your computer is most useful for scanning a single original such as a photo, particularly when you want to adjust scan settings as you scan. By contrast, scanning at the machine is most useful for continuous scanning of multiple originals.

\* An interface standard used for scanners and other image input devices. When the scanner driver is installed on your computer, you can use any TWAIN-compliant application to scan an image.

-  Scanning in PC scan mode is only possible when the scanner driver has been installed from the "Software CD-ROM" using the integrated installer. For the procedures for installing the scanner driver and configuring settings, see the Software Setup Guide.
- This function cannot be used when it has been disabled using "Disable Scan Function" in the system settings (administrator).
- The procedures for selecting the scanner driver and starting scanning vary depending on the TWAIN-compliant application. For more information, see the manual for the application or Help.
- When a large image is scanned at high resolution, the amount of data will be very large and scanning will take a long time. Be sure to select appropriate scan settings for the original (text, photo, etc.).

As an example, the procedure for scanning from the "Sharpdesk" application that accompanies the machine is explained below.

### [At the machine]

1

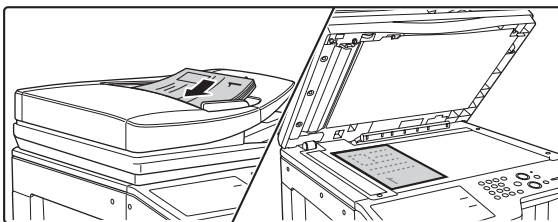

#### Place the original.

Place the original face up in the document feeder tray, or face down on the document glass.

2

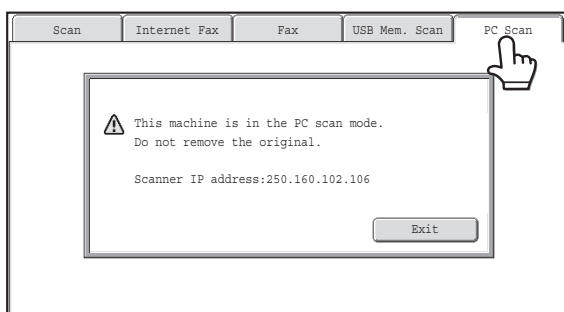

#### Touch the [PC Scan] tab to switch to PC Scan mode.

If the [PC Scan] tab does not appear, touch the  tab to move the screen.

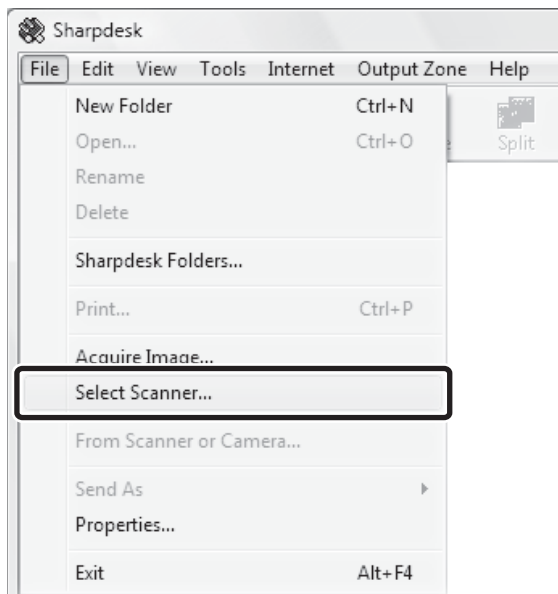

When PC scan mode is selected, only the [Exit] key displayed in the touch panel can be used on the machine; no other keys can be used.

**[At your computer]****3**

Start the TWAIN-compliant application on your computer and select **[Select Scanner]** from the **[File]** menu.

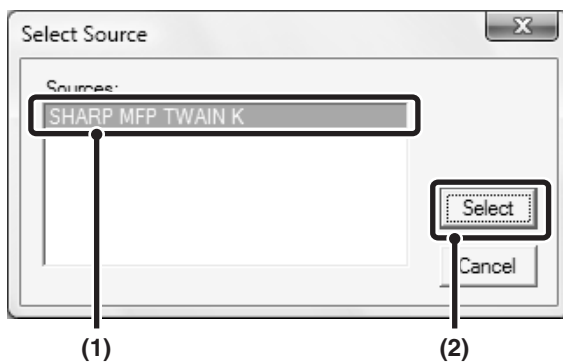
**4**

Select the scanner driver of the machine.

- (1) Select **[SHARP MFP TWAIN K]**.
- (2) Click the **[Select]** button.

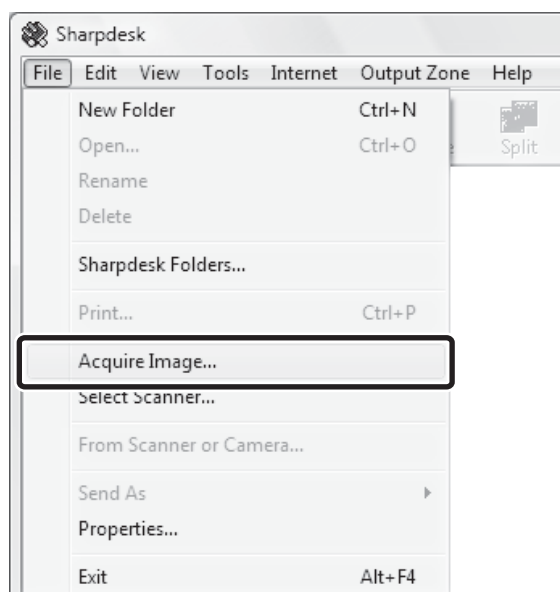
**5**

Select **[Acquire Image]** from the **[File]** menu.

The scanner driver opens.

## 6

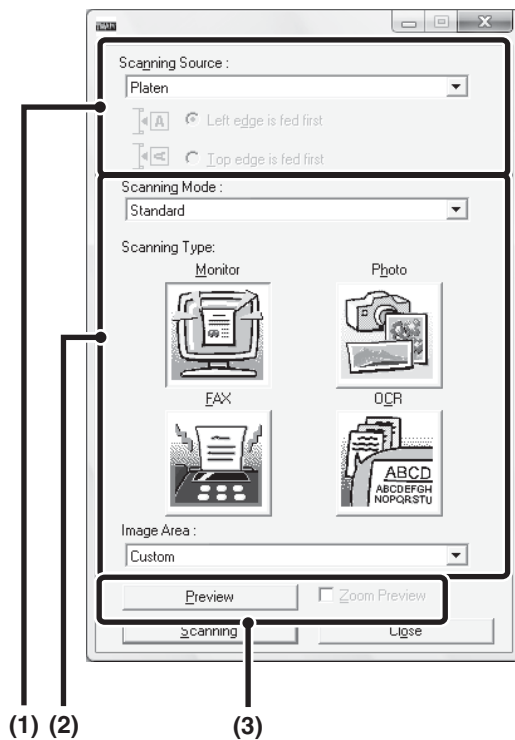

## Preview the image.

### (1) Select the location where the original is placed.

#### "Scanning Source" menu:

- If the original is a one-sided original and is placed in the document feeder tray, select [SPF(Simplex)].
- If the original is a 2-sided original and is placed in the document feeder tray, select [SPF(Duplex - Book)] or [SPF(Duplex - Tablet)] depending on whether the original is a book-style or tablet-style original. In addition, select [Left edge is fed first] or [Top edge is fed first] depending on the orientation of the original.

### (2) Select scan settings.

#### "Scanning Mode" menu:

Switch between the "Standard" screen and the "Professional". In the "Standard" screen, select "Monitor", "Photo", "FAX" or "OCR" depending on the original type and your scanning purpose.

If you wish to change the initial settings of any of the four buttons or select the resolution or other advanced settings, change to the "Professional" screen.

#### "Image Area" menu:

Select the scan area. If "Auto" is selected, the original size detected by the machine will be scanned. You can also set the scanning area in the preview window with your mouse.

### (3) Click the [Preview] button.

The preview image will appear in the scanner driver.

If you are not satisfied with the preview image, repeat (2) and (3).

If the [Zoom Preview] checkbox is selected before the [Preview] button is clicked, the selected area will be enlarged in the preview window. If the checkmark is removed, the preview image will return to normal. Note that if SPF is selected in the "Scanning Source" menu, the [Zoom Preview] function cannot be used.



- For further information on the scan settings, click the  button in the preview image screen of step 7 to open scanner driver Help.
- If the [Preview] button is clicked when scanning from the document feeder tray, only one original page will be scanned for the preview image. If you wish to include that original in the scan, return it to the document feeder tray.



7

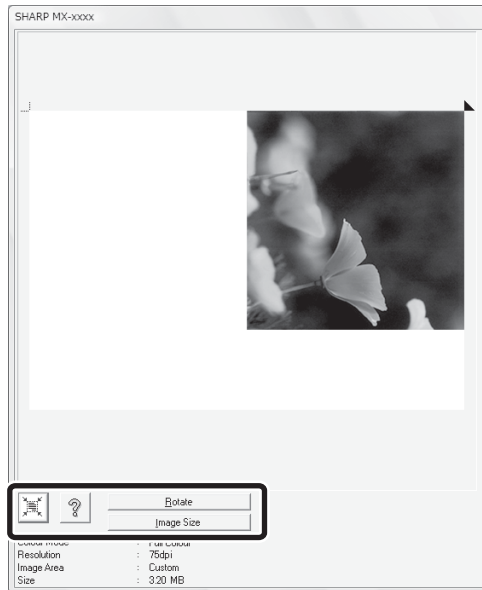

## Select scanning settings while viewing the image.

### [Rotate] button:

Each time this button is clicked, the preview image rotates 90 degrees. This lets you change the orientation of the image without picking up and placing the original again. The image file will be created using the orientation that appears in the preview window.

### [Image Size] button:

Click this button to specify the scan area by entering numerical values. Pixels, mm, or inches can be selected for the units of the numerical values. If a scanning area has already been specified, the entered numbers will change the area relative to the top left corner of the specified area.

### button:

When a preview image is displayed and a scanning area is not specified, you can click the  button to automatically set the scanning area to the entire preview image.



- For further information on the scan settings, click the  button to open scanner driver Help.
- If the originals are placed in the document feeder tray, only the top page will be previewed. The top page will be delivered to the original exit tray. Be sure to return the previewed page to the document feeder tray before previewing again or scanning.

8

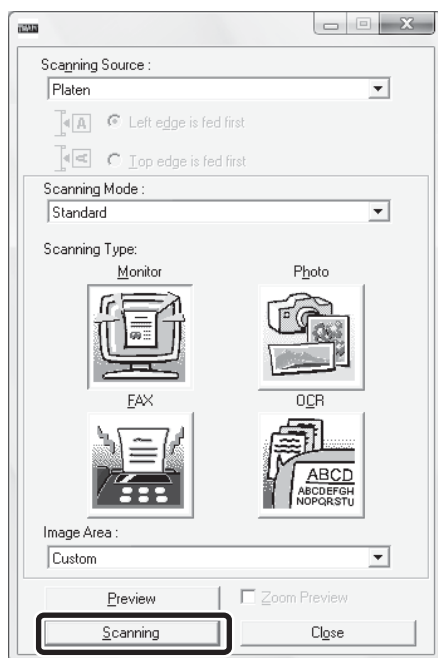

## Click the [Scanning] button.

Scanning begins. The image appears in your application. Assign a file name to the scanned image and save it as appropriate in the software application you are using.

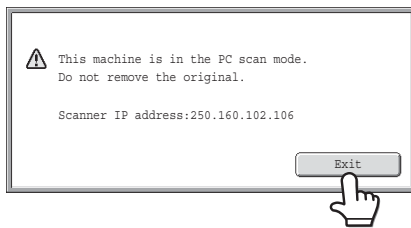
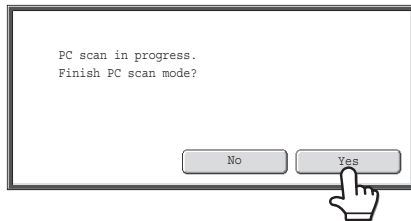
**[At the machine]****9****Touch the [Exit] key in the touch panel.****10****Touch the [Yes] key.**

# METADATA DELIVERY

This section explains metadata delivery, which can be used when the application integration module kit is installed. (On the MX-2314N, the productivity kit is required.)

## METADATA DELIVERY (Data Entry)

When the application integration module kit is installed and an image file is generated for a scan send transmission, metadata (data indicating the attributes of the image file and how it is to be processed) can be generated based on pre-stored information and transmitted as a separate file. The metadata file is created in XML format. By linking the metadata with applications such as document management software, a workflow application, or an encryption server, a sophisticated document solution environment can be built.

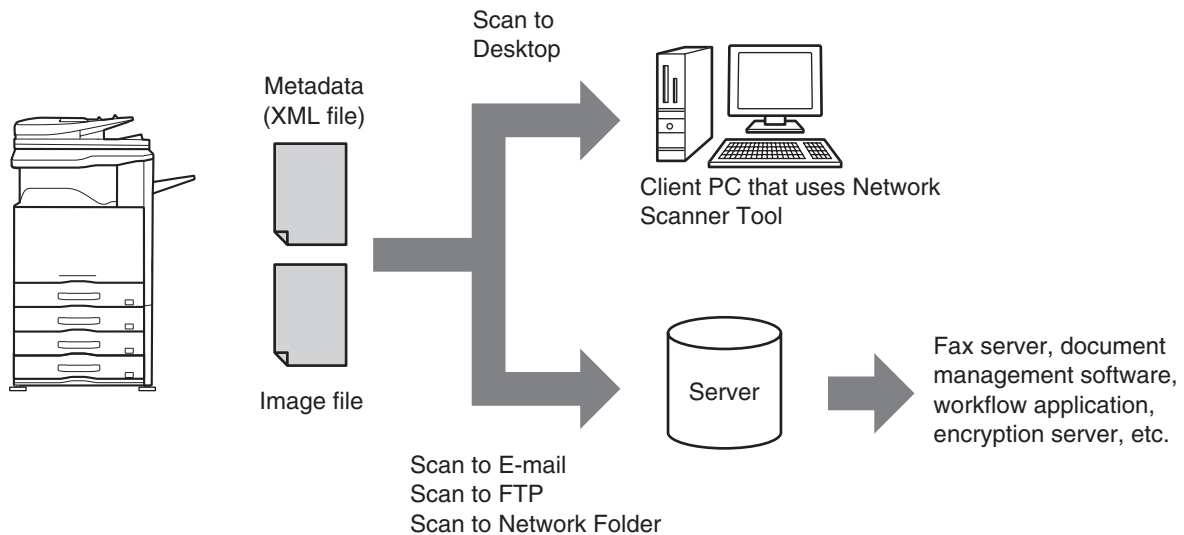

Using the application integration module kit, information on a generated image file can be entered at the touch panel and transmitted along with the image as an XML file.

# PREPARATIONS FOR METADATA TRANSMISSION

## SETTINGS REQUIRED IN THE WEB PAGES

All settings related to metadata are configured in the Web pages. (Administrator rights are required.) To configure metadata settings, click [Application Settings] and then [Metadata Settings] in the Web page menu. When configuring settings, be sure to enable metadata transmission.

### Storing Metadata Sets

Store the items (the metadata set) that are written to the XML file that is generated during scanning. Up to 10 metadata items can be configured in a metadata set. A stored metadata set can be selected at the time of transmission.



Addresses specified in "Address Type Allowing Metadata Entry" when a metadata set is stored can be selected as transmission destinations at the time of transmission using one-touch keys, manual entry, and/or a global address book search. (Addresses for which metadata entry is not allowed cannot be specified as transmission destinations.)

## METADATA TRANSMISSION FOR SCAN TO DESKTOP

When Network Scanner Tool is used in its factory default configuration, a file will be generated with a new file name on the computer. When Network Scanner Tool is used as a means of sending a metadata file to a third party software application, this setting must be disabled to allow cross referencing between the image file and XML file by means of the file name generated by the computer. (When setting the file name in [Send Settings], to ensure that a previously existing file on a computer is not overwritten by a transmitted file of the same name, be sure to configure the file name so that name duplication cannot occur; for example, by including a unique extension (the date, etc.) in the generated file name. If the file name setting is left blank, the machine will automatically generate a file name that is unique.)



- It is recommended that you use Network Scanner Tool to receive metadata. For more information, see the Network Scanner Tool User's Guide (PDF format) on the "Sharpdesk/Network Scanner Utilities" CD-ROM.
- For information on the licence agreement and how to use the CD-ROM that accompanies the application integration module, see the separate "Sharpdesk licence kit" manual.
- **Using third party software applications**  
Various types of third party applications exist. Some applications can start automatically from Network Scanner Tool and some cannot. When the auto-run function of an application is enabled, Network Scanner Tool will start the application with the ".exe" command using the image file name as a parameter. For example, when Network Scanner Tool is set to start application "APP.EXE", the "APP.EXE IMG.TIF" command is applied. If a file was specified to receive metadata, the metadata file name cannot be specified at the same time using the command to start the application directly. (However, the metadata file is stored in the same folder as IMG.TIF in the computer.)

# TRANSMITTING METADATA

Follow the steps below to select a metadata set, enter each item, and perform metadata transmission.

1

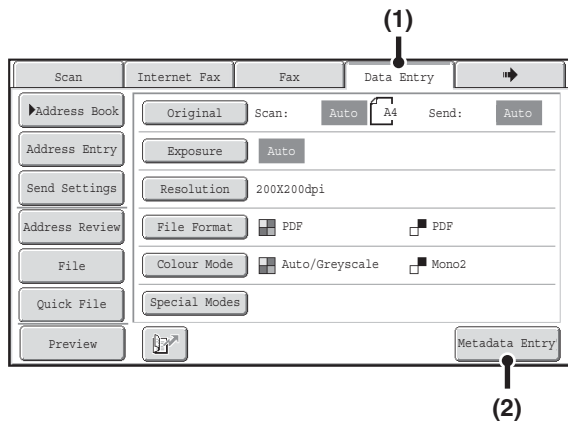

**Switch to data entry mode and display the metadata set screen.**

- (1) Touch the [Data Entry] tab.
- (2) Touch the [Metadata Entry] key.



- If no metadata sets have been stored, the [Data Entry] tab cannot be selected. Store a metadata set in the Web pages and then perform the transmission procedure.
- If a specific metadata set has been specified as the default set, go to step 3.

2

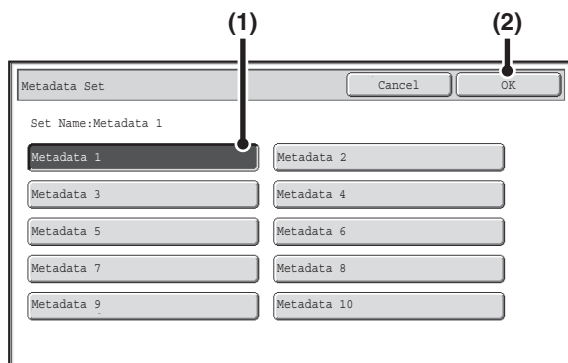

**Select a metadata set.**

- (1) Touch the key of the metadata set that you wish to use.
- (2) Touch the [OK] key.

3



**The keys of the items stored in the metadata set will appear. Touch the key of the item that you want to enter.**



- If you accidentally selected the wrong metadata set or wish to use a different metadata set when a default metadata set has been set, touch the [Metadata Set] key. Touch the [OK] key in the message screen that appears. You will return to the screen of step 1. Metadata items entered to that point will be cancelled.

4

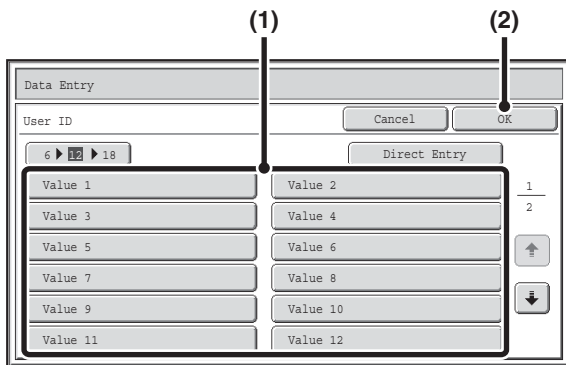

**Enter the selected metadata item.**

**(1) Touch the key of the value that you wish to enter.**

- When the entry values of the metadata item are in the form of selections, the selections are shown as keys. When a value is editable, you can touch the [Direct Entry] key to manually enter the value.
- If the metadata item requires the entry of text, a text entry screen will appear. Enter the required information.

**(2) Touch the [OK] key.**



- To change the number of keys displayed in the screen, touch the number of displayed items selector key. Select 6, 12, or 18 keys.
- For the procedure for entering text, see "ENTERING TEXT" (page 1-70) in "1. BEFORE USING THE MACHINE".

5

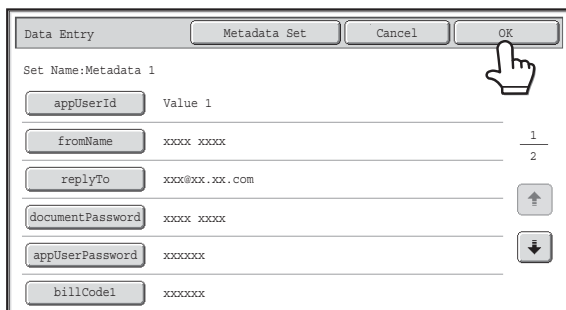

**When you have finished entering all items, touch the [OK] key.**

6

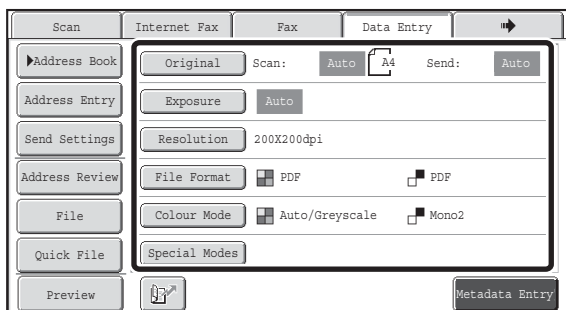

**Select image settings and any other settings, and perform the scan send procedure.**

- The procedures for selecting settings and performing transmission are the same as in the other modes.
- To make changes to entered values, touch the [Metadata Entry] key once again. The entry screen of the selected metadata set will appear.



- Transmission cannot be performed if the [Data Entry] tab is displayed and no metadata settings have been configured. To perform transmission without sending metadata, switch to a different mode by touching the tab of that mode and then perform transmission.
- Before configuring metadata settings, you can specify addresses in all modes to be used. After metadata settings have been configured, only addresses in modes that are allowed in the selected metadata set can be specified.
- When metadata settings have been configured or an address is specified in the [Data Entry] tab, it will not be possible to switch to another mode.
- Metadata delivery is possible using the document filing function. The [Data Entry] tab appears in the transmission settings screen of document filing mode to allow metadata delivery. In addition, metadata delivery using document filing can be performed in [Document Operations] in the Web pages.

# METADATA FIELDS

The following three types of metadata are included in the XML file that is transmitted.

- Data automatically generated by the machine: These data are always included in the XML file and are automatically stored on your computer.
- Previously defined fields: These fields are automatically recognized by the machine and assigned to appropriate XML tags. These fields are selectable, and can only be included in the XML file if enabled in the Web pages.
- User defined fields: Custom fields can be added to the XML file. These fields are selectable and can be defined in the Web pages.

If a defined metadata field is one of the following fields, a message will appear informing you that the field cannot be entered. Enter appropriate information in the related items of the send settings.

Name entered in metadata field	Description	Where entered
fromName	Name of the user who sent the job. If the name is not entered as metadata, the sender name determined by the usual rules for determining the sender name will be applied as metadata.	[Reply-To] (Sender name of selected sender)
replyTo	E-mail address to which the transmission result will be sent.	[Reply-To] (E-mail address of selected sender)
documentSubject	Job name appearing in the e-mail "Subject" line, or job name on the fax cover sheet. When the user enters a [Subject] in the send settings screen in the touch panel, the entered value is applied as metadata.	[Subject] (Blank until a value is set in the send settings screen.)
fileName	Enter the file name of the image to be sent.	[File Name] (Only when the [Allow Custom Filenames] checkbox is selected <input checked="" type="checkbox"/> in the metadata settings screen in the Web pages.) (Blank until a value is set in the send settings screen.)

# NETWORK SCANNER / INTERNET FAX\*1 SPECIFICATIONS

<b>Type</b>	Built-in	
<b>Scanning resolution (dpi)</b>	100 x 100, 200 x 200, 300 x 300, 400 x 400, 600 x 600 Internet Fax: 200 x 100, 200 x 200, 200 x 400, 400 x 400, 600 x 600 (200 x 100, 200 x 200 when file type is TIFF-S) Halftone can be selected for resolutions other than 200 x 100 dpi.	
<b>Scanning speed</b>	Colour (A4 / 8-1/2" x 11") One-sided: 50 pages/min. (200 x 200 dpi), Two-sided: 20 pages/min. (200 x 200 dpi) Black and white (A4 / 8-1/2" x 11") One-sided: 50 pages/min. (200 x 200 dpi), Two-sided: 20 pages/min. (200 x 200 dpi)	
<b>Interface port</b>	LAN connectivity: 10Base-T / 100Base-TX / 1000Base-T	
<b>Supported protocols</b>	TCP/IP (IPv4)	
<b>File formats</b>	Colour (including greyscale)	File types:TIFF, JPEG, PDF, PDF/A, Encrypted PDF, XPS Compression ratio:High / Medium / Low
	Black and white	File types:TIFF, PDF, PDF/A, Encrypted PDF, XPS Compression modes:None / Medium (G3) / High (G4)
	Internet Fax (black and white only)	File types:TIFF-FX (TIFF-F, TIFF-S) Compression modes:Medium (G3) / High (G4)
<b>Remarks</b>	Number of one-touch keys for storing destinations*2	Maximum number of keys: 1000
	Number of destinations that can be stored in a group (1 key)*2	Maximum number of destinations in one group (1 key): 500
	Scan destinations	Scan to E-mail / Scan to FTP / Scan to Desktop / Scan to Network Folder

\*1 The Internet fax expansion kit is required. (On the MX-2314N, the productivity kit is required.)

\*2 Total number of all destinations (Scan to E-mail, Scan to FTP, Scan to Desktop, Scan to Network folder, Internet Fax, Fax, and Group)

## PULL SCAN FUNCTION (TWAIN) SPECIFICATIONS

(On the MX-2314N, the productivity kit is required.)

<b>Supported protocol</b>	TCP/IP (IPv4)
<b>Supported client PC operating systems</b>	Windows XP / Server 2003 / Vista / Server 2008/7/Server 2012/8
<b>Colour modes</b>	Full Colour, Greyscale, Mono Diffusion, Mono 2 gradation
<b>Resolution settings</b>	75 dpi, 100 dpi, 150 dpi, 200 dpi, 300 dpi, 400 dpi, 600 dpi (The resolution can be specified by entering a numerical value from 50 to 9600 dpi. However, when a high resolution is specified, it is necessary to reduce the scanning area.)
<b>Scanning area</b>	Maximum: A3 (11" x 17")



# CHAPTER 6

# DOCUMENT FILING

(On the MX-2314N, the productivity kit is required.)

This chapter provides detailed explanations of the procedures for using the document filing function. The document filing function allows you to save the document data of a copy or fax job, or the data of a print job, as a file on the machine's hard drive. The file can be called up as needed.

This chapter assumes that you are already familiar with copy mode, scanner mode, and the other modes of the machine.

For information on procedures of copy, scanner and other modes that remain the same when those modes are used in conjunction with the document filing function, see the chapters for those modes.

## DOCUMENT FILING

<b>OVERVIEW</b> .....	<b>6-2</b>
• TYPES OF DOCUMENT FILING .....	6-2
• USES OF DOCUMENT FILING .....	6-3
• BEFORE USING DOCUMENT FILING .....	6-4
• IMPORTANT POINTS WHEN USING DOCUMENT FILING .....	6-7
• USING DOCUMENT FILING IN EACH MODE .....	6-8
<b>BASE SCREEN OF DOCUMENT FILING MODE</b> .....	<b>6-10</b>

## SAVING FILES WITH DOCUMENT FILING

<b>SAVING A FILE WITH "Quick File"</b> .....	<b>6-11</b>
<b>SAVING A FILE WITH "File"</b> .....	<b>6-13</b>
• FILE INFORMATION .....	6-15
<b>SAVING A DOCUMENT FILE ONLY (Scan to HDD)</b> .....	<b>6-18</b>
• "Scan to HDD" SCREEN .....	6-18
• PERFORMING "Scan to HDD" .....	6-23

## USING STORED FILES

<b>SEQUENCE FOR USING A STORED FILE</b> .....	<b>6-24</b>
<b>FOLDER AND FILE SELECTION SCREENS</b> .....	<b>6-26</b>
• FOLDER SELECTION SCREEN .....	6-26
• FILE SELECTION SCREEN .....	6-27
<b>SELECTING A FILE</b> .....	<b>6-29</b>
• JOB SETTINGS SCREEN .....	6-30
<b>PRINTING A STORED FILE</b> .....	<b>6-31</b>
• PRINT SETTINGS SCREEN .....	6-32
• MULTI-FILE PRINTING .....	6-33
<b>SENDING A STORED FILE</b> .....	<b>6-37</b>
• SEND SETTINGS SCREEN .....	6-38
<b>PROPERTIES OF STORED FILES</b> .....	<b>6-39</b>
• FILE PROPERTIES .....	6-39
• CHANGING THE PROPERTY .....	6-39
<b>MOVING A STORED FILE</b> .....	<b>6-41</b>
<b>DELETING A STORED FILE</b> .....	<b>6-43</b>
<b>CHECKING AN IMAGE OF A STORED FILE</b> .....	<b>6-44</b>
• IMAGE CHECK SCREEN .....	6-45
<b>RETRIEVING AND USING A FILE FROM THE JOB STATUS SCREEN</b> .....	<b>6-46</b>
<b>SEARCHING FOR A STORED FILE</b> .....	<b>6-47</b>

# DOCUMENT FILING

This section provides information that you should know before using the document filing function, including an overview of document filing, the features and functions of document filing, and points to keep in mind when using document filing.

## OVERVIEW

The document filing function allows you to save the document image of a copy or image send job, or the data of a print job, as a file on the machine's hard drive.

The stored file can be retrieved and printed or transmitted as needed.

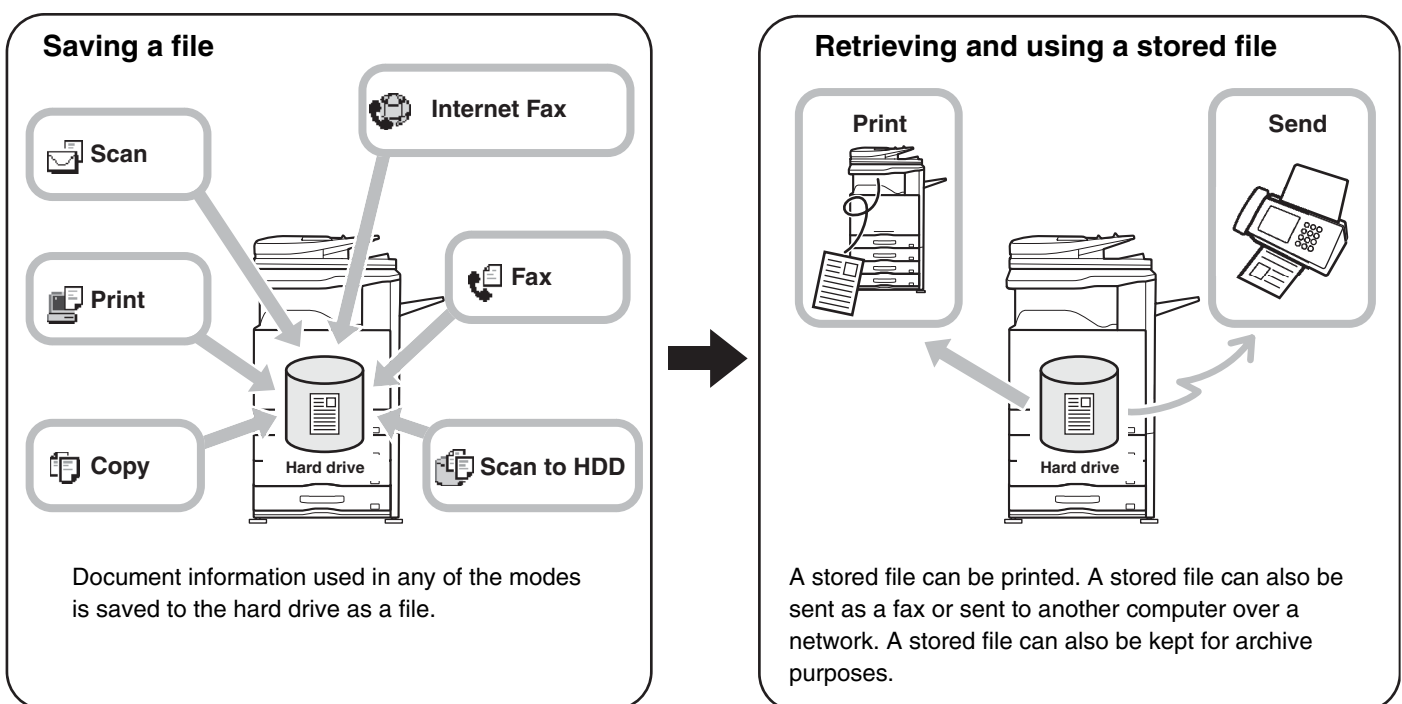

## TYPES OF DOCUMENT FILING

There are three ways to save a file using document filing: "Quick File", "File", and "Scan to HDD".

<b>Quick File</b>	<p>As a copy, scan send, or other job is performed, this function saves the document data to the hard drive. Use this function when you want to quickly and easily store document data without specifying a file name or other information.</p> <p>The stored file can also be used by other people. Do not use this method to save files that you do not want others to use, such as files containing sensitive or confidential information.</p>
<b>File</b>	<p>As a copy, scan send, or other job is performed, this function saves the document data to the hard drive. Unlike Quick File, various types of information can be appended to the file when the file is saved to enable efficient file management.</p> <p>A password can also be established to prevent the file from being retrieved up by others.</p>
<b>Scan to HDD</b>	<p>This function scans a document and stores it as a file. Like File, various types of information can be appended to the file when it is stored.</p>

# USES OF DOCUMENT FILING

## Quickly using a file

Example: You prepared handouts consisting of numerous pages for a meeting, however, another handout is needed for a newly added participant.

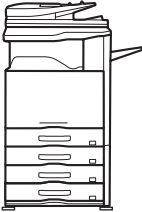
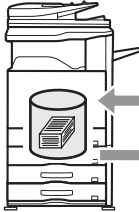
The handout was not saved using document filing	The handout was saved using document filing
 <p>Ratio, colour mode, and special mode settings must be reselected.</p> <p>The numerous original pages must all be rescanned.</p> <p style="text-align: center;">↓</p> <p>Not likely to be completed in time for the meeting...</p>	 <p>The stored file is simply retrieved and printed.</p> <p style="text-align: center;">↓</p> <p>Printing is accomplished quickly and the handout is ready in time for the meeting!</p>
<p>Copy settings must be reselected and the original must be rescanned.</p> <p>As indicated above, to obtain another set of output, the settings must be selected all over again. If you don't remember the settings, much effort may be expended to get the same output result as the previous time.</p>	<p>By retrieving a job stored using document filing, there is no need to reselect copy settings or rescan the original. The job can be retrieved and printed using the same settings quickly and easily.</p>

As shown in the example, storing a job with the document filing function frees you of the need to rescan the original and select settings, saving considerable time.

## Convenient for managing frequently used documents

Example: Managing a large number of business forms

### Not using document filing

It takes time to find the form you need.

### Using document filing

The required form can be easily retrieved from the document filing list, and document management is much more efficient.

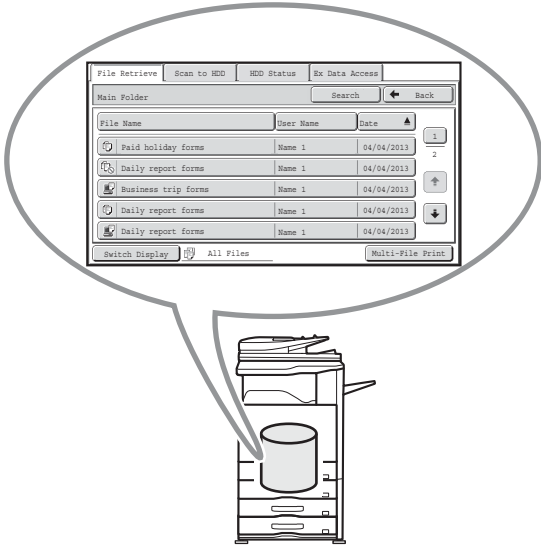

Application forms, report forms, and other business forms can be stored on the hard drive for easy retrieval, letting you print the number of copies you need when you need them.

# BEFORE USING DOCUMENT FILING

This section provides information that you should know before using the document filing function.

## Folders

Three types of folders are used to store files by document filing.

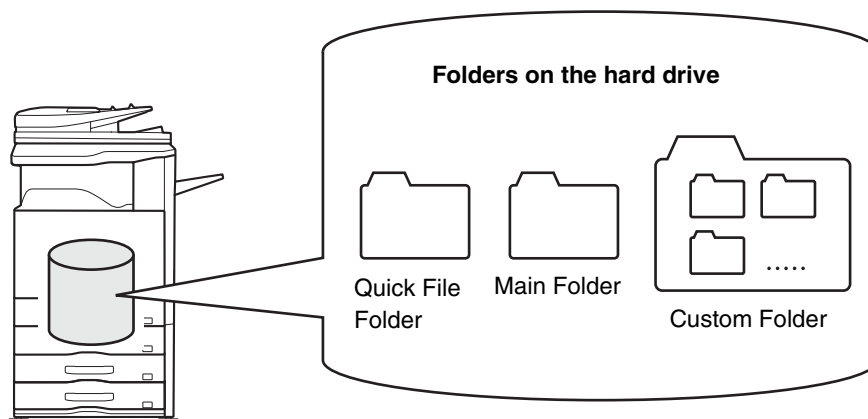

### Quick File Folder

Documents scanned using the [Quick File] key are stored in this folder. A user name and file name are automatically assigned to each job.

### Main Folder

Documents scanned using the [File] key are stored in this folder.

When you store a job in the Main folder, you can specify a previously stored user name and assign a file name.

A password can also be set when storing a file ([Confidential] save).

### Custom Folder

Folders with custom names can be created inside this folder.

When a document is scanned using the [File] key and a folder is selected, the document is stored in the specified folder.

Like the Main folder, a custom folder allows you to specify a previously stored user name and assign a file name when storing a job.

Passwords can be established for custom folders and for files saved in custom folders.



A maximum of 1000 custom folders can be created on the hard drive.

## Items convenient to store

When storing a job using "File" or "Scan to HDD", it is convenient to store the items below. These settings are not needed when storing a job using "Quick File".

<b>User Name</b>	This is necessary if you will be assigning a user name to stored files. User names are stored in "User List" in the system settings (administrator). A user name is also used as a search condition when searching for a file.
<b>Custom Folder</b>	The Main folder is initially available as a location for storing files by "File" and "Scan to HDD". When custom folders have been created using "Document Filing Control" in the system settings, a custom folder can be specified as a location for storing files. A password can also be established for a custom folder to restrict access to the folder.
<b>My Folder</b>	"My Folder" is specified using "User List" in the system settings (administrator). A previously created custom folder can be selected as "My Folder", or a new folder created as "My Folder". When "My Folder" has been configured and user authentication is used, "My Folder" will always be selected as the destination of "File" and "Scan to HDD".



- **System Settings: Document Filing Control (page 7-26)**



This is used to create custom folders for document filing. A password can also be established for a custom folder.

- **System Settings (Administrator): User List**



This is used to store a user name and specify a folder as "My Folder".

# Approximate number of pages and files that can be stored by document filing

Combined total number of pages and total number of files that can be stored in custom folders and in the Main folder

Examples of original types	Number of pages*	Number of files
<b>Full colour original</b> (Text and photo example)  Size: A4 (8-1/2" x 11")	Max. 6000	Max. 3000
<b>Black &amp; white original</b> (Text)  Size: A4 (8-1/2" x 11")	Max. 14000	

## Number of pages and number of files that can be stored in the Quick File folder

Examples of original types	Number of pages*	Number of files
<b>Full colour original</b> (Text and photo example)  Size: A4 (8-1/2" x 11")	Max. 1000	Max. 1000
<b>Black &amp; white original</b> (Text)  Size: A4 (8-1/2" x 11")	Max. 2800	

\* The indicated numbers are guidelines for the number of pages that can be stored when all pages are full colour, and when all pages are black & white.

Copying in sort mode uses the same memory area as the Quick File folder. For this reason, when too much data has been stored in the Quick File folder, it may not be possible to perform a large copy job using sort mode. Delete unneeded files.

The original types above are examples to make the explanation easier to understand. The actual number of pages and number of files that can be stored will vary depending on the contents of the original images and the settings when the files are stored.

## Automatic deletion of files

You can have document filing data in specified folders automatically deleted at regular intervals by specifying the folders and the time. Periodic deletion of files stored in the machine helps to prevent the leaking of sensitive information and frees space on the hard drive.

Every day, every week, or every month can be selected for the deletion cycle, and a time can be set for each selection. For example, you can set file deletion to take place every week on Friday at 6:00 PM.

Automatic file deletion settings are configured in "Automatic Deletion of File Settings" in the system settings (administrator).

To check the settings, print the following list in the system settings.

To check information on the deletion cycle: Print the "Administrator Settings List" in the system settings (administrator).

To check information on the folders selected for file deletion: Print the "Document Filing Folder List" in the system settings.



When "Automatic Deletion of File Settings" is enabled in the system settings (administrator), all files in the specified folders will be deleted when the set time arrives. Take care not to store files that you wish to keep in folders specified for file deletion.



- **System Settings: [Document Filing Control](#) (page 7-26)**

This shows a list of the folder names for document filing.

- **System Settings (Administrator): Automatic Deletion of File Settings**

Configure settings for automatic deletion at regular intervals of files stored using the document filing function.

- **System Settings (Administrator): Administrator Settings List**

Use this to print a list of the administrator settings, including document filing settings.

## Files

When a file is saved using "File", the following information can be appended.

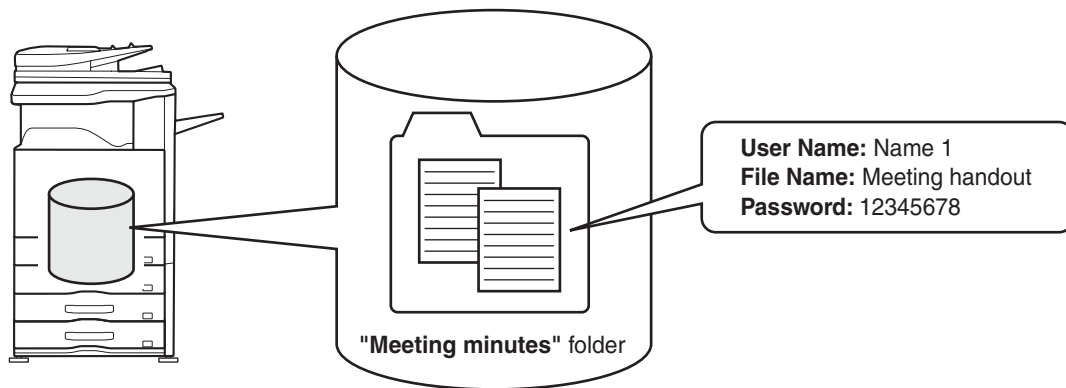

Saving a file with this information allows you to distinguish it from other files.

**User name:** Use this to specify the owner of the file. The user name must first be stored in "User List" in the system settings.

**File Name:** A file name can be entered.

**Folder:** Select which folder the file will be saved in.

**Confidential:** A password (5 to 8 digits) can be established to prevent others from using the file.



The above information cannot be specified when a file is saved with Quick File.



### System Settings (Administrator): User List

This is used to store user names.

## IMPORTANT POINTS WHEN USING DOCUMENT FILING

Note the following when using document filing:

- Files saved using "Quick File" are assigned the "Sharing" property. "Sharing" files can be retrieved and printed or transmitted by anyone, and thus Quick File should not be used to save sensitive or confidential documents that you do not wish others to use.
- When saving a file with "File", use the "Confidential" property. A password can be set for a "Confidential" file to prevent the file from being used by other people. Take care to keep the password of a stored "Confidential" file secret.
- The property of a stored "Confidential" file can be changed to "Sharing" by "Property Change" when the file is used. Do not store sensitive documents or documents that you do not want to be used by others.
- Except in cases provided for by law, SHARP Corporation bears no responsibility for any damages that result from the leaking of sensitive information due to manipulation by a third party of any data saved using the Quick File function or File function, or incorrect operation of the Quick File function or File function by the operator that saves the data.

# USING DOCUMENT FILING IN EACH MODE

In copy or image send mode, the original can be saved as a file on the hard drive at the same time it is copied or transmitted. In addition, Scan to HDD can be used to save the scanned data of an original to the hard drive without copying or transmitting the data.

## Copy mode

The original is saved as an image file at the same time it is copied.

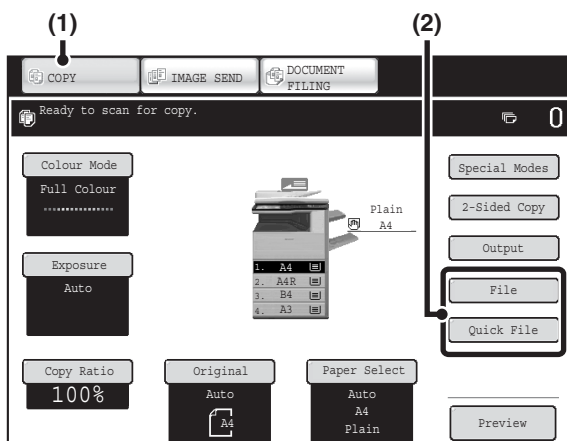

- (1) Touch the [COPY] key.
- (2) Touch the [File] key or the [Quick File] key.

## Image Send mode

### Example: Base screen of scan mode

The original is saved as an image file at the same time it is scanned and transmitted.

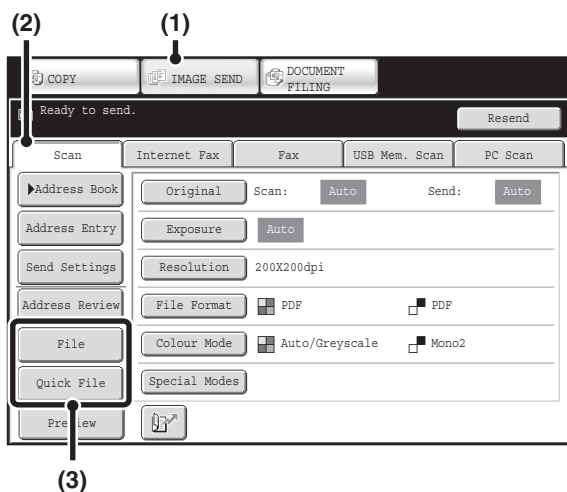

- (1) Touch the [IMAGE SEND] key.
- (2) Touch the [Scan] tab.
- (3) Touch the [File] key or the [Quick File] key.



## Scan to HDD mode

The scanned original is saved as an image file. Neither printing nor transmission are performed when Scan to HDD is used.

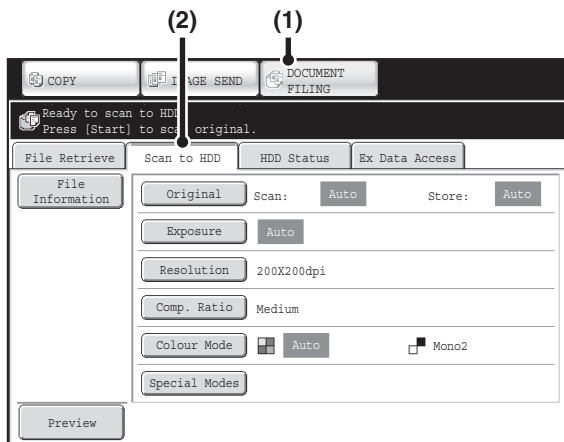

(1) Touch the [DOCUMENT FILING] key.

(2) Touch the [Scan to HDD] tab.

**[File] key and [Quick File] key**  
 The "File" key and/or "Quick File" key will not appear in the base screen of copy mode or image send mode if one or both of the keys has been changed to a different function using "Customize Key Setting" in the Web page menu. In this case, touch the [Special Modes] key in the base screen of either mode. Document filing can be performed by touching the [Quick File] key or [File] key in the special modes menu.

### Using document filing in print mode

To use document filing in print mode, select document filing in the printer driver. For more information on using document filing in print mode, see "[CONVENIENT PRINTER FUNCTIONS](#)" (page 3-58) in "3. PRINTER".

### Using document filing in PC-Fax/PC-I-Fax mode

To use document filing in PC-Fax or PC-I-Fax mode, select document filing settings in the PC-Fax driver. For more information, see Help in the PC-Fax driver.

**System Settings (Administrator): Customize Key Setting**  
 Registration is performed in [System Settings] - [Operation Settings] - "Customize Key Setting" in the Web page menu.

# BASE SCREEN OF DOCUMENT FILING MODE

Touch the [DOCUMENT FILING] key in the touch panel to open the base screen of document filing mode. Files stored on the hard drive in the machine can be retrieved from this screen.

When user authentication is used and My Folder is configured, the file selection screen of My Folder will appear. If the user that logged in does not have My Folder configured, the folder selection screen will appear.

☞ [FOLDER SELECTION SCREEN](#) (page 6-26)

☞ [FILE SELECTION SCREEN](#) (page 6-27)

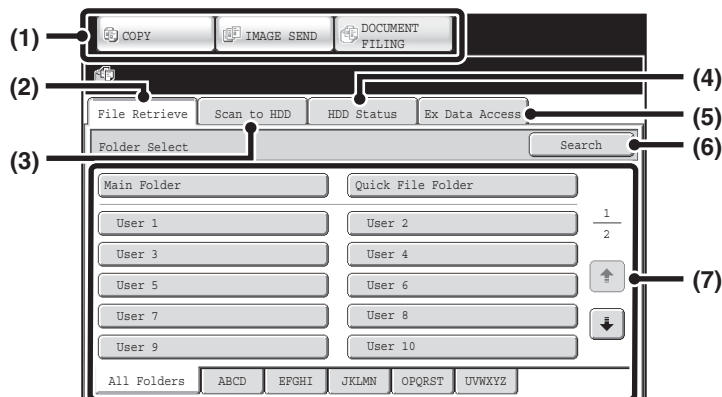

## (1) Mode switch keys

Use these keys to switch between copy, image send, and document filing modes.

To switch to document filing mode, touch the [DOCUMENT FILING] key.

## (2) [File Retrieve] tab

Touch this tab to retrieve a file stored by document filing. The folder selection screen will appear.

☞ [FOLDER SELECTION SCREEN](#) (page 6-26)

## (3) [Scan to HDD] tab

Touch this key to select Scan to HDD. Neither printing nor transmission are performed.

The file will be stored in the Main folder or a custom folder.

☞ [SAVING A DOCUMENT FILE ONLY \(Scan to HDD\)](#) (page 6-18)

## (4) [HDD Status] tab

Touch this key to check how much of the machine's hard drive is being used.

The amount used is shown as a percentage.

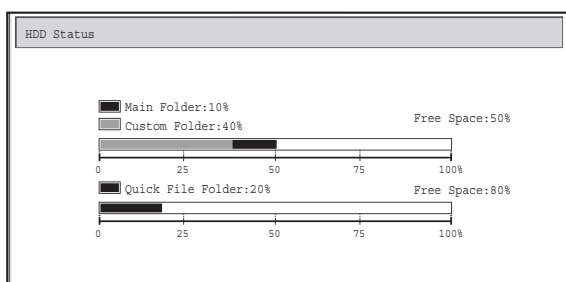

## (5) [External Data Access] tab

This can be selected when an FTP server is stored or a USB memory device is connected to the machine.

☞ ["DIRECTLY PRINTING FROM THE MACHINE"](#) (page 3-62) in "3. PRINTER"

## (6) [Search] key

Touch this key to search for a file stored in a folder. You can search using the user name, file name, or folder name.

☞ [SEARCHING FOR A STORED FILE](#) (page 6-47)

## (7) When retrieving a stored file, use this to select the folder where the file is stored.

☞ [FOLDER SELECTION SCREEN](#) (page 6-26)

# SAVING FILES WITH DOCUMENT FILING

This chapter explains how to save an original as an image file using the Quick File, File, and Scan to HDD functions of document filing mode.

## SAVING A FILE WITH "Quick File"

When copying, printing or transmitting a document in copy mode, print mode, or image send mode (excluding USB memory scan mode), "Quick File" can be selected to save an image of the document to the Quick File folder. The image can be retrieved at a later time, allowing you to print or transmit the document without having to locate the original.

As an example, the procedure for storing a document in the Quick File folder while copying is explained below.

1

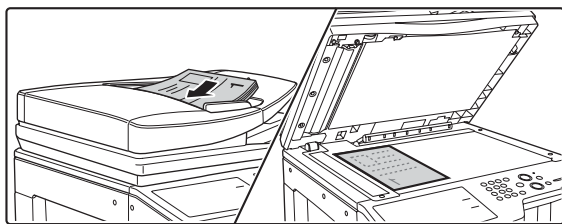

### Place the original.

Place the original face up in the document feeder tray, or face down on the document glass.

2

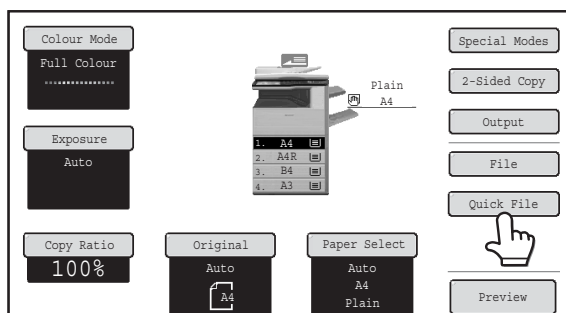

### Touch the [Quick File] key.

3

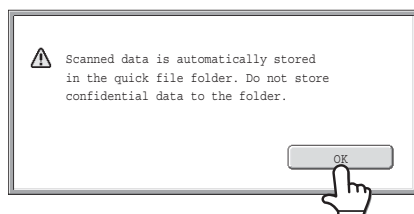

### Touch the [OK] key.

You will return to the base screen of copy mode and the [Quick File] key will be highlighted.



#### To cancel Quick File...

Touch the [Quick File] key in the screen of step 2 so that it is not highlighted after you touch the [OK] key.

## 4

**Select copy settings and then press the [COLOUR START] key or the [BLACK & WHITE START] key.**

- Copying begins and the scanned document image is saved to the hard drive.  
The selected copy settings are also saved.
- To prevent accidental saving of the document, the message "The scanned data is stored in the quick file folder." appears for 6 seconds (default setting) after the [START] key is pressed.  
The message display time can be changed using "Message Time Setting" in the system settings (administrator).
- If you inserted the original pages in the document feeder tray, all pages are scanned.
- If you placed the original on the document glass, scan each page one page at a time.  
When scanning of one page finishes, replace it with the next page and press the same [START] key that you pressed initially.  
Repeat until all pages have been scanned and then press the [Read-End] key.

**To cancel scanning...**Press the [STOP] key (.

When a file is stored using Quick File, the following user name and file name are automatically assigned to the file.

User Name: User Unknown

File Name: Mode\_Day-Month-Year\_Hour-Minute-Second

(Example: Copy\_04042013\_112030)

Stored to: Quick File Folder

When user authentication is used, the user name that was used for login is automatically selected.

Only the file name and location of a file stored in the Quick File Folder can be changed.

**To cancel Quick File...**

Touch the [Quick File] key in the screen of step 2 so that it is no longer highlighted.

**System Settings (Administrator): Delete All Quick Files**

With the exception of protected files, all files in the quick file folder can be deleted at once.

Settings can be configured to delete all files by key operation and to have all files automatically deleted when the power is turned on.

# SAVING A FILE WITH "File"

When copying, printing or transmitting a document in copy mode, print mode, or image send mode (excluding USB memory scan mode), "File" can be selected to save an image of the document to the Main folder or a previously created custom folder. The image can be retrieved at a later time, allowing you to print or transmit the document without having to locate the original.

As an example, the procedure for using "File" while copying is explained below.

1

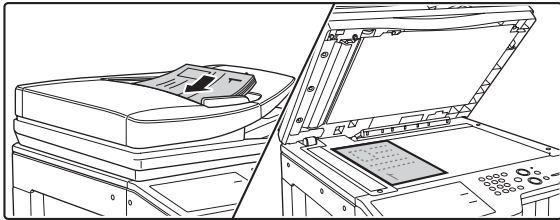

## Place the original.

Place the original face up in the document feeder tray, or face down on the document glass.

2

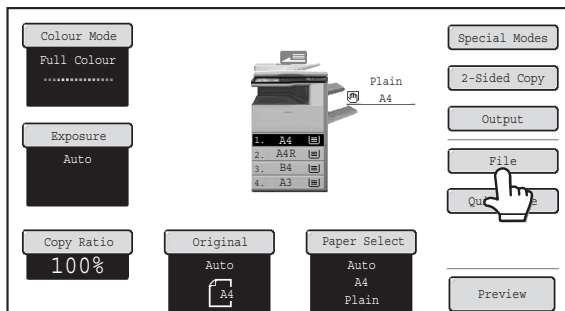

## Touch the [File] key.

3

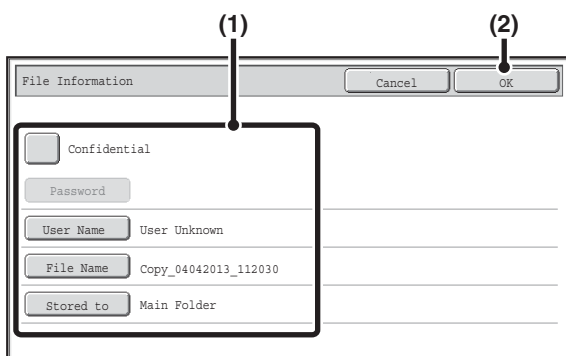

## Select the "File" settings.

### (1) Select file information settings.

To select the user name, file name, folder, and confidential setting, see "[FILE INFORMATION](#)" (page 6-15).

- [Specifying a user name](#): page 6-15
- [Assigning a file name](#): page 6-16
- [Specifying the folder](#): page 6-16
- [Storing a file as a confidential file](#): page 6-17

After configuring the above settings, you will return to this screen. Go to the next step.

If you do not wish to assign a user name or other information to the file, go to the next step.

### (2) Touch the [OK] key.

You will return to the base screen of copy mode and the [File] key will be highlighted.

## 4

**Select copy settings and then press the [COLOUR START] key or the [BLACK & WHITE START] key.**

- Copying begins and the scanned document image is saved to the hard drive. The selected copy settings are also saved.
- For the procedure for placing the original, see step 4 of "[SAVING A FILE WITH "Quick File"](#)" (page 6-11).

**To cancel scanning...**

Press the [STOP] key (⏹).



When a file is stored using File without appending file information, the following user name and file name are automatically assigned to the file.

User Name: User Unknown

File Name: Mode\_Day-Month-Year\_Hour-Minute-Second

(Example: Copy\_04042013\_112030)

Stored to: Main Folder

When user authentication is used, the user name that was used for login is automatically selected.

**To cancel the File operation...**

Touch the [Cancel] key in the screen of step 3.

# FILE INFORMATION

This section explains the settings that are configured in step 3 of "SAVING A FILE WITH "File"" (page 6-13). Specifying a user name, file name, folder, and confidential setting makes it easier to manage and search for a file. In addition, when confidential is selected and a password is established, other people will not be able to view the file without permission.

## Specifying a user name

1

### Touch the [User Name] key.

When user authentication is used, the user name that was used for login is automatically selected. In this case, this step is not needed.



The user name must be previously stored in "User List" in the system settings (administrator).

2

### Touch the desired user name in the list of user names that is displayed.

#### (1) Select the user name.

There are two ways to select the user name:

##### (A) Touch the key of the user name.

The touched user name is highlighted.

If you accidentally select the wrong user name, touch the key of the correct name.

##### (B) Touch the key.

An area for entering the "Registration No." [----] appears in the message display. Enter the "Registration No." set during user registration. This will allow you to select the user name.

#### (2) Touch the [OK] key.

The user name that you touched is selected and you return to the screen of step 1. The selected user name appears.

# Assigning a file name

A file name can be assigned to the file.

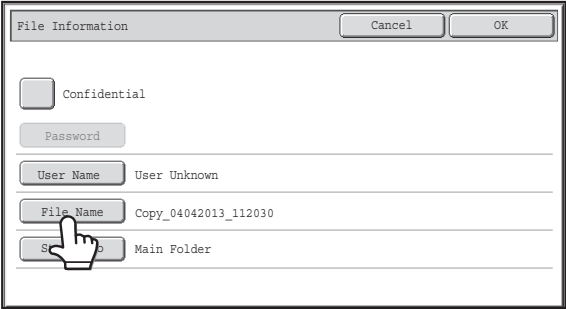

## Touch the [File Name] key.

A text entry screen will appear. Enter the file name and touch the [OK] key.

A maximum of 30 characters can be entered.

# Specifying the folder

1

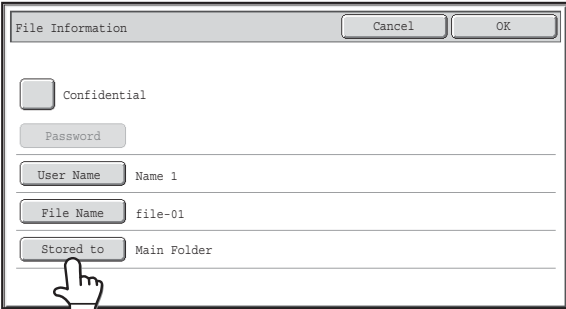

## Touch the [Stored to:] key.



If a user name with a "My Folder" setting is selected, "My Folder" of that user will automatically be selected.

2

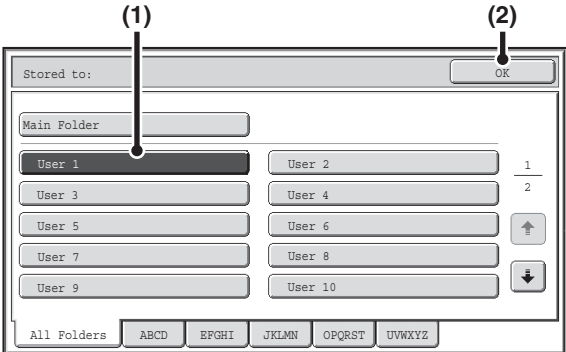

## Select the folder in which you want to store the file.

### (1) Touch the key of the folder where you want to store the file.

If a password has been set for the folder, a password entry screen appears. Enter the password of the touched folder with the numeric keys (5 to 8 digits) and touch the [OK] key.

### (2) Touch the [OK] key.



## Storing a file as a confidential file

A password can be set for the file to prevent others from viewing it. Set a password (5 to 8 digits) with the numeric keys.

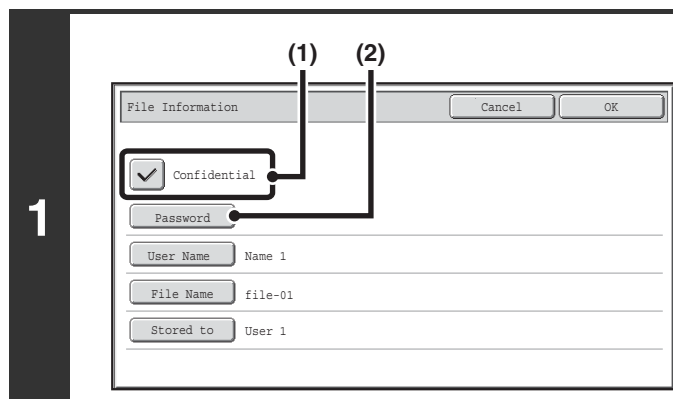

### Enable the confidential property.

- (1) Select the [Confidential] checkbox so that a checkmark  appears.

Confidential mode is enabled and a password can be entered.

- (2) Touch the [Password] key.

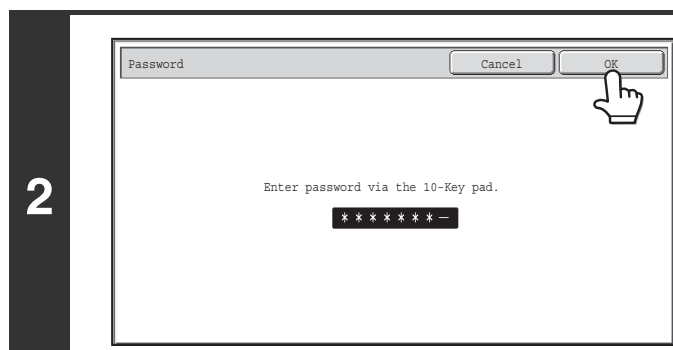

### Enter a password (5 to 8 digits) with the numeric keys and touch the [OK] key.

As each digit is entered, "-" changes to "\*".

# SAVING A DOCUMENT FILE ONLY (Scan to HDD)

Scan to HDD is used to store a scanned document in the Main folder or a custom folder. Neither printing nor transmission are performed.

## "Scan to HDD" SCREEN

The following screen appears when the [Scan to HDD] tab is touched in document filing mode. Touch the keys below to select Scan to HDD settings.

The current setting of each key appears to the right of the key.

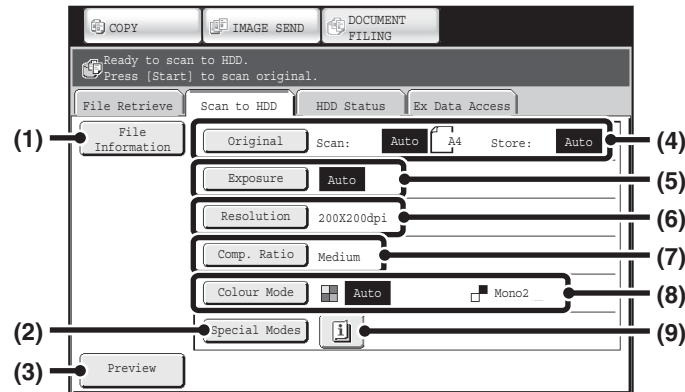

### (1) [File Information] key

Information can be appended to a file stored by Scan to HDD. The settings are configured in the same way as file information for "File".

☞ [FILE INFORMATION](#) (page 6-15)

### (2) [Special Modes] key

Use this key to select special modes for Scan to HDD.

☞ [Special modes screen for Scan to HDD](#) (page 6-21)

### (3) [Preview] key

Touch to check the image to be stored before performing Scan to HDD.

☞ [Checking the image before storing it \(Preview\)](#) (page 6-22)

### (4) [Original] key

Touch this key to set the scanning size, storing size and orientation of the original, and select 2-sided scanning settings.

☞ [\[Original\] key](#) (page 6-19)

### (5) [Exposure] key

Touch this key to select the exposure for scanning.

### (6) [Resolution] key

Use this to select the resolution that will be used when the file is transmitted.

When "Long Size" is specified, only resolution settings of 300 X 300 dpi and under can be selected.

### (7) [Comp. Ratio] key

Use this to select the colour compression ratio that will be used when the file is stored in colour.

### (8) [Colour Mode] key

Use this key to select the colour mode when storing a document.

☞ [\[Colour Mode\] key](#) (page 6-20)

### (9) key

This key appears when a special mode or 2-sided scanning is selected. Touch the key to display the selected special modes.

## [Original] key

When the [Original] key is touched, the following screen appears. This screen is used to change the original size and select scanning settings for 2-sided originals.

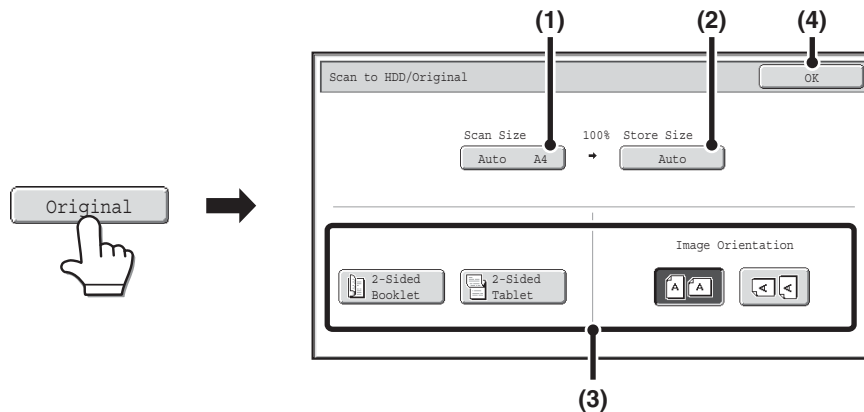

### (1) Touch the [Scan Size] key.

If the original is a non-standard size that cannot be detected by auto original size detection, touch the [Scan Size] key and specify the original size.

### (2) Touch the [Store Size] key.

If you wish to store the file at a different size than the original size, touch the [Store Size] key and change the store size.

### (3) Touch the appropriate orientation key.

If the top edge of the original is up, touch the key. If the top edge of the original is to the left, touch the key.

If the original is a 2-sided original, touch the [2-Sided Booklet] key or the [2-Sided Tablet] key as appropriate for the original type.

### (4) Touch the [OK] key.

The settings are stored and you return to the Scan to HDD screen.

## [Exposure] key

To adjust the exposure, touch the [Exposure] key.

Select an appropriate exposure mode for the original and touch the or key to adjust the exposure level.

When finished, touch the [OK] key.

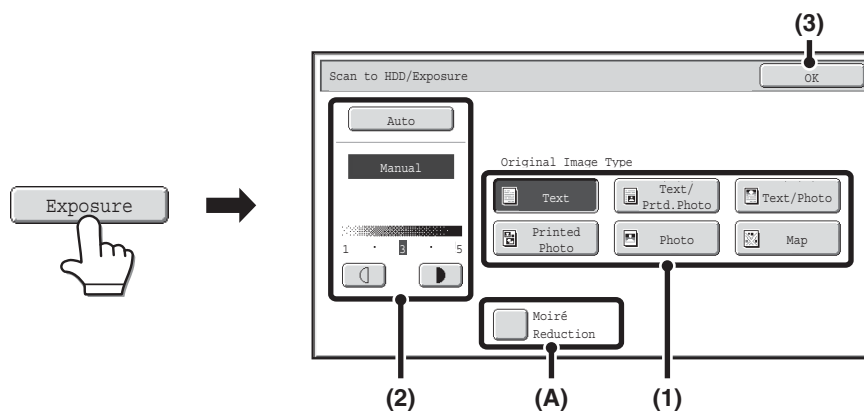

### (1) Select the appropriate original type for the original to be scanned.

### (2) Select [Auto] or [Manual].

If you selected [Manual], touch the or key to adjust the exposure. (For a darker image, touch the key. For a lighter image, touch the key.)

When the exposure is set to [Auto], the keys cannot be used.

#### (A): Moirè Reduction

To reduce the moirè effect when scanning printed matter, touch the [Moirè Reduction] checkbox so that a checkmark  appears.

### (3) Touch the [OK] key.

The settings are stored and you return to the Scan to HDD screen.

## [Colour Mode] key

Touch the [Colour Mode] key to open the colour mode setting screen for Scan to HDD.

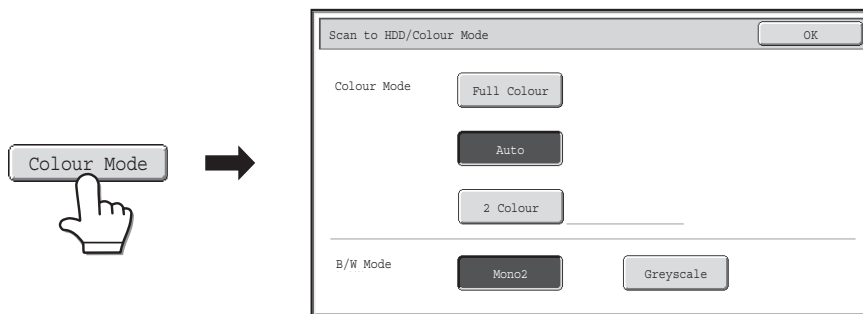

The following settings can be selected for the scanning colour when the [COLOUR START] key or the [BLACK & WHITE START] key is pressed.

Start key	Mode	Scanning method
<b>[COLOUR START] key</b>	Full Colour	The original is scanned in full colour. This mode is best for full colour originals such as catalogues. Even when the original is black and white, it is scanned as a full colour original.
	Auto	The machine detects whether the original is colour or black and white and automatically selects full colour or black and white (greyscale) scanning.
	2 Colour	Only the red areas of the original are changed to the selected colour; colours other than red are scanned in black. Red, green, blue, cyan, magenta, or yellow can be selected.
<b>[BLACK &amp; WHITE START] key</b>	Mono 2	Colours in the original are scanned as black or white. This mode is best for text-only originals.
	Greyscale	The colours in the original are scanned in black and white as shades of grey (greyscale).

When you have finished selecting the mode, touch the [OK] key.

## Special modes screen for Scan to HDD

When the [Special Modes] key is touched, the following screen appears. For more information on each setting, see "SPECIAL MODES" (page 5-71) in "5. SCANNER / INTERNET FAX".

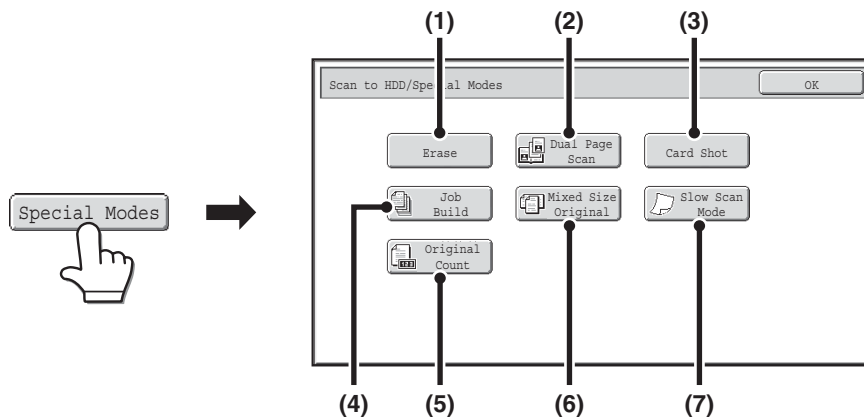

**(1) [Erase] key**

The erase function is used to erase shadow lines on images produced when scanning thick originals or books on the document glass.

**(2) [Dual Page Scan] key**

The left and right sides of an original can be scanned as two separate pages. This function is useful when you wish to successively scan each page of a book or other bound document.

**(3) [Card Shot] key**

This function lets you store the front and reverse sides of a card as a single file.

**(4) [Job Build] key**

This function lets you separate a many-page original into sets, scan each set using the automatic document feeder, and store all pages as a single file. Use this function when there are more original pages than can be placed at once in the auto document feeder.

**(5) [Original Count] key**

When using the automatic document feeder to scan an original, you can check whether or not the correct number of pages were scanned before storing the document.

**(6) [Mixed Size Original] key**

This feature lets you scan originals of different sizes at the same time; for example, B4 (8-1/2" x 14") size originals mixed together with A3 (11" x 17") size originals. When scanning the originals, the machine automatically detects the size of each original.

Originals of mixed widths and sizes can be scanned (A3 and B4, A3 and B5, A4 and B4, A4 and B5, B4 and A4R, B4 and A5, B5 and A4R, B5 and A5 (11" x 17" and 8-1/2" x 14", 11" x 17" and 8-1/2" x 13", 11" x 17" and 5-1/2" x 8-1/2")).

**(7) [Slow Scan Mode] key**

Use this function when you wish to scan thin originals using the automatic document feeder. This function helps prevent thin originals from misfeeding.

## Checking the image before storing it (Preview)

If you touch the [Preview] key and then start Scan to HDD, the screen below appears.

Before the scanned data is stored, you can check a preview of the scanned image in this screen and return to the Scan to HDD settings screen to change settings.

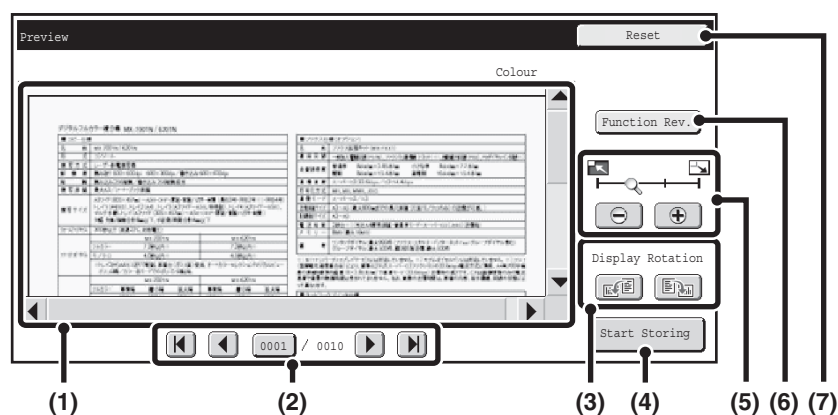

### (1) Preview image

This shows an image of the selected file.

If the image is cut off, use the scroll bars at the right and bottom of the screen to scroll the image. Touch a bar and slide it to scroll. (You can also touch the keys to scroll.)

### (2) Change page keys

When there are multiple pages, use these keys to change pages.

- keys: Go to the first or the last page.
- keys: Go to the previous page or the next page.
- Page number display: This shows the total number of pages and the current page number. You can touch the current page number key and enter a number with the numeric keys to go to that page number.

### (3) "Display Rotation" key

This rotates the image right or left by 90 degrees. The rotation applies to all pages in the file, not just the displayed page.

### (4) [Start Storing] key

This starts Scan to HDD.

### (5) Display zoom key

Use this to set the zoom ratio of the displayed image. Changes from the left in the order "Full Page", "Twice", "4 Times", "8 Times". The setting applies to all pages in the file, not just the displayed page.

### (6) [Function Rev.] key

Use this to check special mode settings and original settings.

### (7) [Reset] key

Use this key if you need to change settings after checking an image or settings. You will return to the setting screen.

Only the original settings can be changed after the preview image is viewed.



- A preview image is an image for display on the touch panel. Differs from the actual storage result.
- Depending on the size of the image, part of the image may be clipped off in the preview screen on the touch panel.

# PERFORMING "Scan to HDD"

1

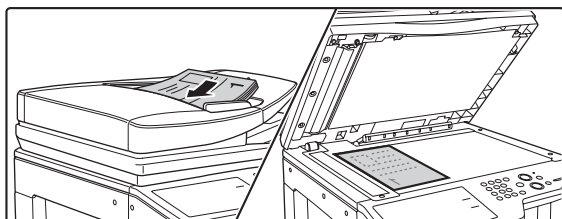

## Place the original.

Place the original face up in the document feeder tray, or face down on the document glass.

2

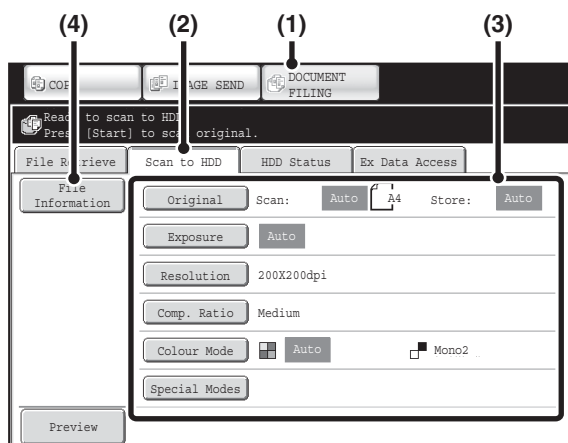

## Switch to document filing mode and select Scan to HDD settings.

- (1) Touch the [DOCUMENT FILING] key.
- (2) Touch the [Scan to HDD] tab.  
If you do not wish to select settings, go to the next step.
- (3) Select the original size, exposure, resolution, compression ratio, colour mode, and special modes.  
See "["Scan to HDD" SCREEN](#)" (page 6-18).
- (4) Touch the [File Information] key.  
The settings are the same as for "File". See "[FILE INFORMATION](#)" (page 6-15).



If the original is 2-sided, be sure to touch the [Original] key and then touch the [2-Sided Booklet] key or the [2-Sided Tablet] key as appropriate for the original.

3

## Press the [COLOUR START] key or the [BLACK & WHITE START] key .

Scanning begins.

For the procedure for placing the original, see step 4 of "[SAVING A FILE WITH "Quick File"](#)" (page 6-11).

When Preview is enabled, the preview screen appears.

[Checking the image before storing it \(Preview\)](#) (page 6-22)

A beep will sound to indicate that Scan to HDD is completed.



### To cancel scanning...

Press the [STOP] key ().



When Scan to HDD is performed without appending file information, the following user name and file name are automatically assigned to the file.

User Name: User Unknown

File Name: Mode\_Day-Month-Year\_Hour-Minute-Second  
(Example: HDD\_04042013\_112030)

Stored to: Main Folder

When user authentication is used, the user name that was used for login is automatically selected.

# USING STORED FILES

This section explains how to retrieve a file stored by document filing and print or transmit the file.

## SEQUENCE FOR USING A STORED FILE

This section explains the basic procedure for retrieving and using a stored file. The screens and procedures differ depending on whether or not user authentication is enabled.

See the sequence that applies to your situation.

For information on user authentication procedures, see "[USER AUTHENTICATION](#)" (page 1-17) in "1. BEFORE USING THE MACHINE". For information on enabling user authentication and storing user names, see "[User Control](#)" (page 7-47) in "7. SYSTEM SETTINGS".

 Files stored by document filing can also be retrieved and used from the Web pages. Click [Document Operation] and then [Document Filing] in the Web page menu, and select the folder that contains the file you wish to use. You can also show a preview of a stored file in the web pages.

### Change the mode.

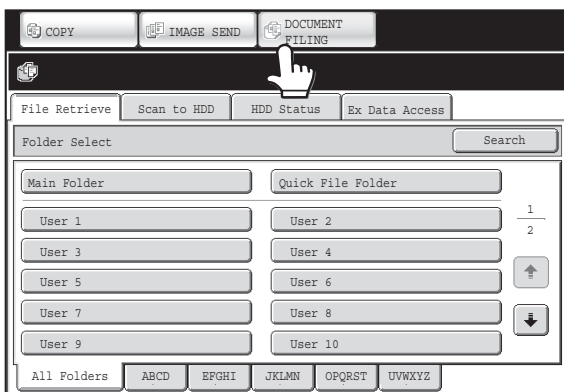

Switch to document filing mode.

 [BASE SCREEN OF DOCUMENT FILING MODE](#) (page 6-10)



## Select the file that you wish to retrieve.

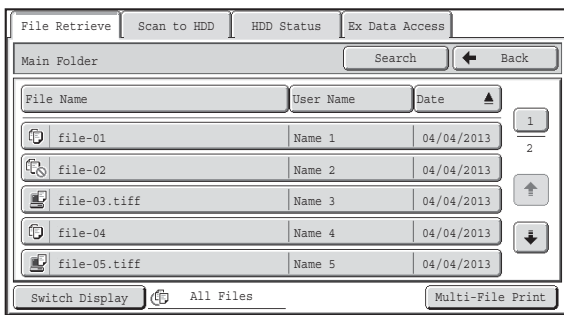

- Select the folder in the folder selection screen. When the folder is selected, the files in the folder will appear. Select the file that you wish to retrieve.
- Thumbnail images of the stored files can be displayed for file selection.
  - ☞ [FILE SELECTION SCREEN](#) (page 6-27)
  - ☞ [SELECTING A FILE](#) (page 6-29)
- The search function can be used to retrieve a file.
  - ☞ [SEARCHING FOR A STORED FILE](#) (page 6-47)



## Select the operation.

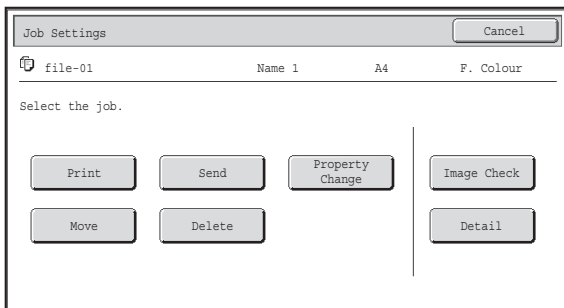

Select the desired operation and configure settings.

- ☞ [JOB SETTINGS SCREEN](#) (page 6-30)
- ☞ [PRINTING A STORED FILE](#) (page 6-31)
- ☞ [SENDING A STORED FILE](#) (page 6-37)
- ☞ [PROPERTIES OF STORED FILES](#) (page 6-39)
- ☞ [MOVING A STORED FILE](#) (page 6-41)
- ☞ [DELETING A STORED FILE](#) (page 6-43)
- ☞ [CHECKING AN IMAGE OF A STORED FILE](#) (page 6-44)

# FOLDER AND FILE SELECTION SCREENS

To use a file stored by document filing, the folder and file must be selected. The folder selection screen and file selection screen are explained below.

## FOLDER SELECTION SCREEN

Two different screens appear depending on whether or not user authentication is enabled on the machine.

### When user authentication is not enabled

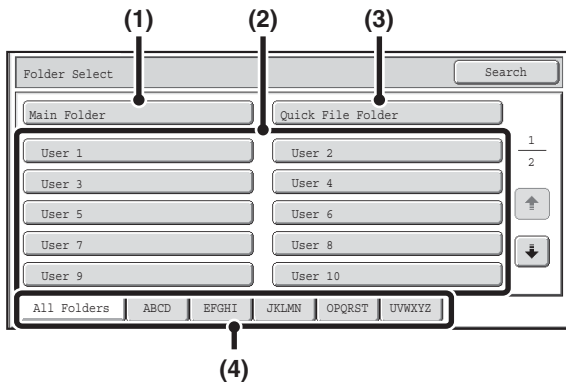

### When user authentication is enabled

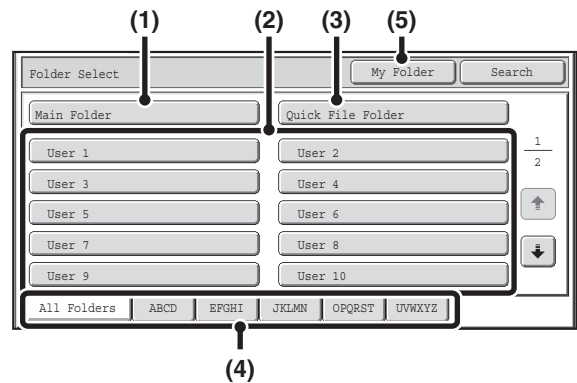

#### (1) [Main Folder] key

Touch this key to retrieve a file from the Main folder. The files in the Main folder will appear.

#### (2) Custom folder keys

The custom folders that have been created using "[Document Filing Control](#)" (page 7-26) in system settings are displayed. Touch a key to display the files in that folder.

If a password has been set for a custom folder, a password entry screen will appear when the folder is touched. The password must be entered.

#### (3) [Quick File Folder] key

Touch this key to retrieve a file from the Quick File folder. The files in the Quick File folder will appear.

🔗 [SAVING A FILE WITH "Quick File"](#) (page 6-11)

#### (4) Index tabs

All folders appear on the [All Folders] tab.

Touch a tab to display the custom folders whose initials (set in "Document Filing Control" in the system settings) match the letters on the tab.

#### (5) [My Folder] key

This key appears when user authentication is enabled. Touch the key to display the file selection screen of "My Folder". When user authentication is enabled but "My Folder" is not configured, this key will be greyed out to prevent selection.

# FILE SELECTION SCREEN

The file selection screen of the Quick File folder, Main folder, and custom folders is explained below.

The file selection screen can be displayed in "List screen" format or "Thumbnail screen" format. (To select the format, see "(5) [Switch Display] key" below.)

This chapter assumes that the "List screen" format is selected.

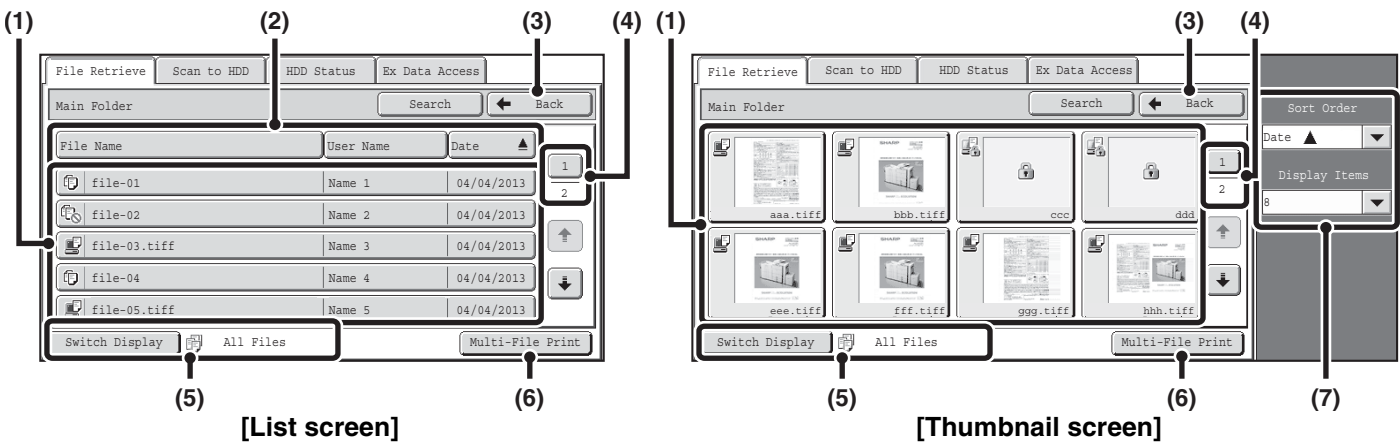

## (1) File keys

The stored files are displayed. An icon showing which mode the file was stored from, the file name, the user name, and the date the file was stored appear in each file key.

When a file is touched, the job setting screen appears.

### Job icons

	Copy		Internet fax transmission Direct SMTP transmission		Print
	Fax transmission		Scan to E-mail		Scan to HDD
	Scan to FTP		Scan to Desktop		Scan to Network Folder
	PC-Fax transmission		PC-I-Fax transmission		

### Thumbnail screen

The first page of thumbnail images of the stored files appears.

The confidential icon () will appear instead of a thumbnail image for files stored as confidential files.

## (2) [File Name] key, [User Name] key, [Date] key

Use these keys to change the order of display of the file keys. When one of the keys is touched, or appears in the key.

- When appears in the [File Name] key or [User Name] key, the files appear by file name or user name in ascending order.

When appears in the [Date] key, the files appear in order from the oldest date.

- When appears in the [File Name] key or [User Name] key, the files appear by file name or user name in descending order.

When appears in the [Date] key, the files appear in order from the most recent date.

## (3) [Back] key

Touch this key to return to the base screen of document filing mode.

[FOLDER SELECTION SCREEN](#) (page 6-26)

## (4) Page key

When multiple pages exist, use this key to enter the number of a page that you want to display. When the key is touched, a page number entry screen appears. Enter the desired page number (3 digits) with the numeric keys. For example, to display page 3, enter "003".

## (5) [Switch Display] key

The displayed file keys can be changed by job type and can be displayed as thumbnail images. The currently selected job type appears to the right of the [Switch Display] key. [All Files] is initially selected. When the [Switch Display] key is touched, the following screen appears.

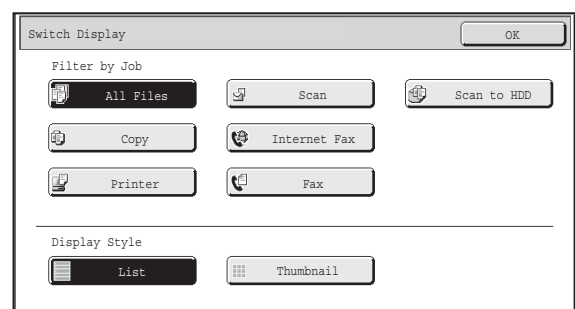

If you wish to display only the file keys of a specific job type, select the job type from the job type display at the top of the screen.

To display thumbnail images of the files, touch the [Thumbnail] key. To change from the thumbnail screen to the list screen, touch the [List] key. When finished, touch the [OK] key.

**(6) [Multi-File Print] key**

Touch this to select multiple files in a folder for printing.

 [MULTI-FILE PRINTING](#) (page 6-33)

**(7) Sort Order / Display Items**

This can be used in the thumbnail screen.

The order of display of the file thumbnails can be changed in "Sort Order".

Select "Date ▲", "Date ▼", "File Name ▲", "File Name ▼", "User Name ▲", or "User Name ▼".

The number of displayed file thumbnails can be changed in "Display Items".

Select 2 thumbnails or 8 thumbnails.

# SELECTING A FILE

This section explains how to select a file to be used.

1

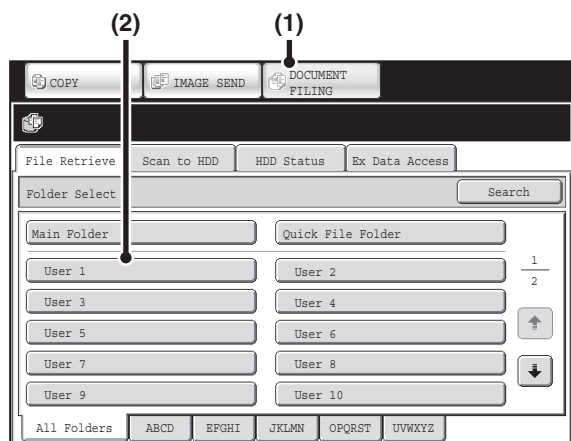

**Select the folder that contains the file you wish to use.**

**(1) Touch the [DOCUMENT FILING] key.**

The folder selection screen will appear. If a different tab appears, touch the [File Retrieve] tab.

When user authentication is enabled and "My Folder" is configured in "User List" in the system settings, the custom folder specified as "My Folder" opens. To display the folder selection screen, touch the [Back] key.

**(2) Touch the key of the folder that contains the desired file.**

If a password is set for the selected folder, a password entry screen will appear.

Enter the password with the numeric keys (5 to 8 digits) and touch the [OK] key.

2

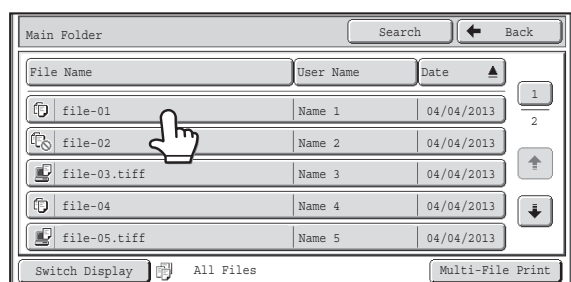

**Touch the key of the desired file.**

If a password is set for the selected file, a password entry screen will appear.

Enter the password with the numeric keys (5 to 8 digits) and touch the [OK] key.



- Touch the [Switch Display] key to display the keys of a particular mode such as copy or scanner mode, or to display thumbnail images of the files.  
The [Switch Display] key allows you to quickly find a file.
- You can touch the [File Name] key, the [User Name] key, or the [Date] key to change the order of display of the files.
- The [Multi-File Print] key can be touched to select multiple files in a folder for printing.  
📄 [MULTI-FILE PRINTING](#) (page 6-33)
- When "Display only the Files of Logged-in Users" is enabled under System Settings (Administrator): Authority Group List (Document Filing), only files saved by the currently logged-in user are displayed.

# JOB SETTINGS SCREEN

When a file key is touched, the following screen appears. Touch the key of the operation that you wish to perform and select settings.

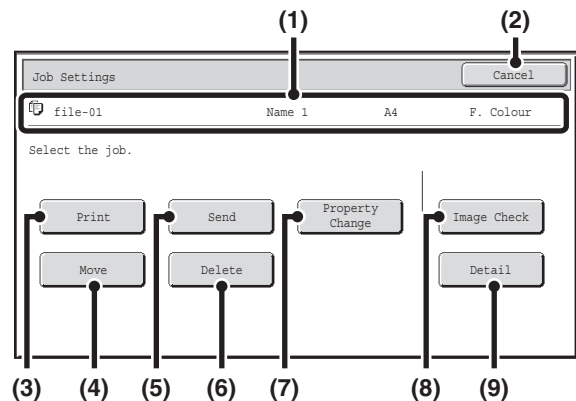
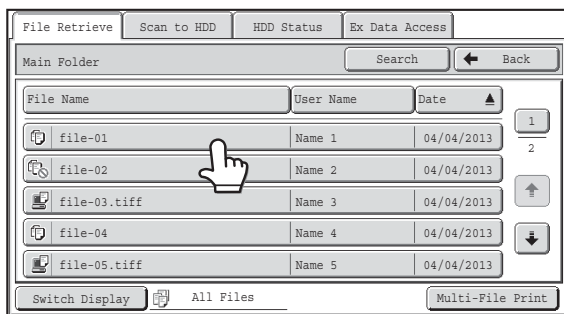

## (1) File display

This shows information on the currently selected file (job icon, file name, user name, store size, and colour mode).

## (2) [Cancel] key

Touch this key to cancel the operation and return to the file selection screen.

## (3) [Print] key

Touch this key to print the selected file.

➤ [PRINTING A STORED FILE](#) (page 6-31)

## (4) [Move] key

Use this procedure to change the location of a file (move a file to a different folder).

➤ [MOVING A STORED FILE](#) (page 6-41)

## (5) [Send] key

This is used to send a stored file by fax, Internet fax, scan send, or other method.

➤ [SENDING A STORED FILE](#) (page 6-37)

## (6) [Delete] key

Touch this key to delete a file that is no longer needed.

➤ [DELETING A STORED FILE](#) (page 6-43)

## (7) [Property Change] key

Use this key to change the property ("Sharing", "Protect", or "Confidential") of a stored file.

➤ [PROPERTIES OF STORED FILES](#) (page 6-39)

## (8) [Image Check] key

An image of the stored file appears.

➤ [CHECKING AN IMAGE OF A STORED FILE](#) (page 6-44)

## (9) [Detail] key

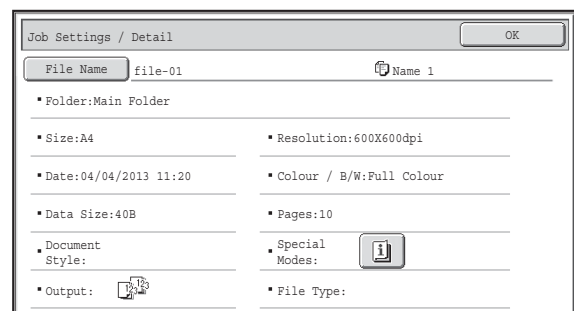

Touch this key to show detailed information on the selected file.

When this key is touched, the following screen appears.



If you wish to change the file name, touch the [File Name] key in this screen.

A text entry screen will appear. Enter the desired file name.

The  key appears when a special mode is selected. Touch the  key to display the special mode selection confirmation screen.

# PRINTING A STORED FILE

A file stored using document filing can be retrieved and printed when needed. The settings used when the file was stored are also stored, and thus the file can be printed again using those settings. The file can also be modified before printing by changing the print settings.

After selecting the desired file, follow the steps below.

☞ [SELECTING A FILE](#) (page 6-29)

1

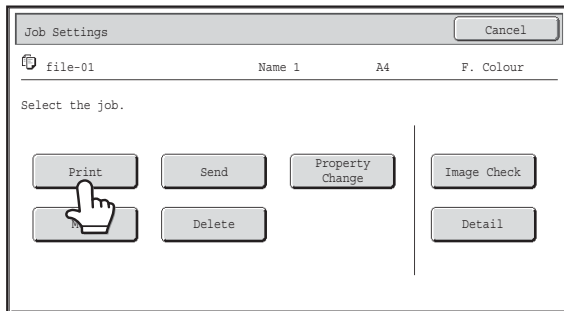

Touch the [Print] key.

2

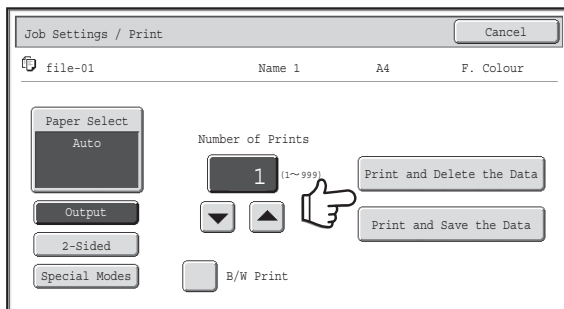

Touch the [Print and Delete the Data] key or the [Print and Save the Data] key.

If the [Print and Delete the Data] key is touched, the files will be automatically deleted after printing.

If the [Print and Save the Data] key is touched, the files will be saved after printing.

Output settings, 2-sided printing, special modes, the number of copies, and other settings can be selected. For more information, see "[PRINT SETTINGS SCREEN](#)" (page 6-32).



- A file saved in black and white or greyscale cannot be printed in colour.
- When a long size document is stored from Scan to HDD or scan mode, the file cannot be printed. A file stored from scan mode that included fax mode or Internet fax mode destinations in a broadcast transmission can be printed.
- If print settings are changed when a stored file is printed, the only changed setting that can be stored is the number of copies.
- The printing speed may be somewhat slow depending on the resolution and exposure mode settings of the stored file.

# PRINT SETTINGS SCREEN

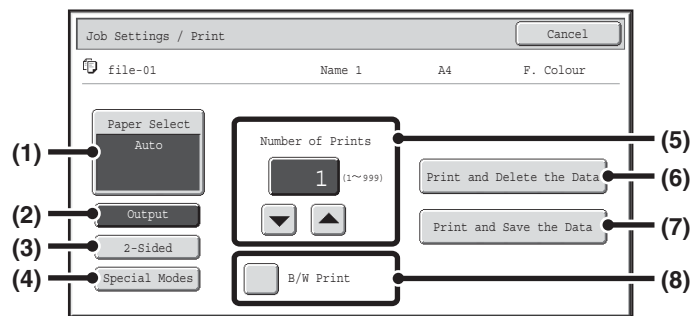

**(1) [Paper Select] key**

Use this key to set the paper size.

**(2) [Output] key**

Use this key to select Sort, Group or Staple Sort, and to select the output tray.

**(3) [2-Sided] key**

Use this key to select the orientation of the image on the reverse side of the paper for 2-sided printing. To have the front and back images oriented in the same direction, touch the [2-Sided Booklet] key. To have the front and back images oriented opposite to each other, touch the [2-Sided Tablet] key. Note that the size and orientation of the saved image may cause these keys to have the opposite effect. If neither of these keys is selected (neither is highlighted), 1-sided printing will take place.

**(4) [Special Modes] key**

Touch this key to select "Margin Shift", "Pamphlet Style", "2in1 / 4in1", "Tandem Print", or "Stamp". This key does not appear if the file was saved from print mode.

**(5) [Number of Prints] key**

Use these keys to set the number of copies. The number of copies can also be selected by directly touching the numeric display and changing the number with the numeric keys.

**(6) [Print and Delete the Data] key**

Printing begins when this key is touched. When printing is finished, the file will be automatically deleted.

**(7) [Print and Save the Data] key**

Printing begins when this key is touched. The file will not be deleted after printing.

**(8) [B/W Print] checkbox**

Select this checkbox if the file was saved in colour and you wish to print it in black & white. When the file is saved in black & white, this checkbox does not appear.



# MULTI-FILE PRINTING

Multiple files in a folder can be selected for printing.

1

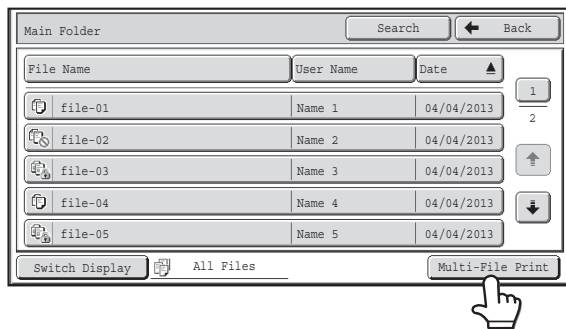

## Touch the [Multi-File Print] key.

To select files of a particular job type, touch the [Switch Display] key, select the job type from the screen that appears, and touch the [OK] key.

Touch the [Switch Display] key to show only files of a selected job type.

2

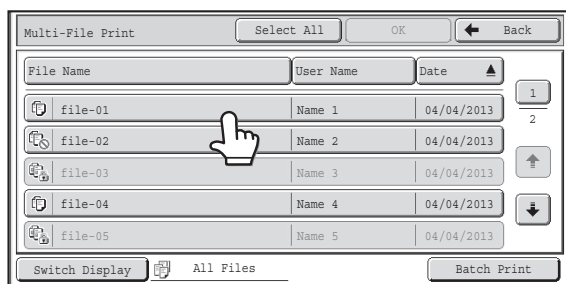

## Select the keys of the files that you wish to print.

Touch the keys of the files that you wish to print. Touched file keys will be highlighted to indicate that they have been selected.

To cancel the selection of a file, touch the highlighted file key so that it is no longer highlighted.

To select all displayed file keys except those of confidential files, touch the [Select All] key.

The [Batch Print] key can be used to print all files of a particular user in a folder or all files that have the same password in a folder. For more information, see "[Batch printing](#)" (page 6-35).



- Multi-file printing of confidential files is not possible.
- A file in the currently selected folder cannot be selected simultaneously with a file in a different folder.
- If the job type is changed with the [Switch Display] key or the screen is changed with the [Back] key while a file is selected, the selection of the file will be cancelled.
- When the [Select All] key is touched, it will change into the [Cancel All] key. To cancel the selection of all files that was made with the [Select All] key, touch the [Cancel All] key.
- If all files are selected without using the [Select All] key, the key will not change into the [Cancel All] key. If selection of all files is cancelled without using the [Cancel All] key, the key will remain the [Cancel All] key.

3

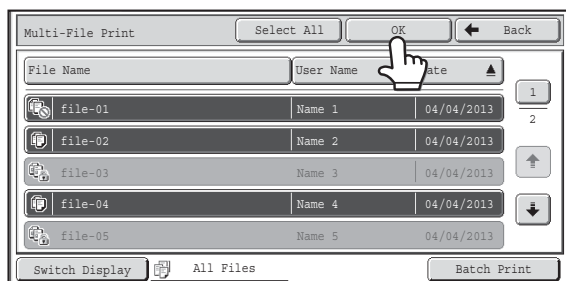

## Touch the [OK] key

The selected file is entered and the screen changes to the print screen.

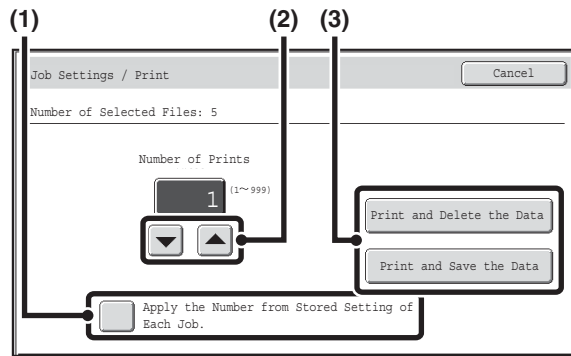

## Printing a selected file.

The number of selected files appears in the number of selected files display.

If you wish to use the number of copies that was stored with the file, go to step (3).

- (1) Touch the [Apply the Number from Stored Setting of Each Job] checkbox so that it is not selected () .
- (2) Set the number of copies with the   keys.
- (3) Touch the [Print and Delete the Data] key or the [Print and Save the Data] key.

If the [Print and Delete the Data] key is touched, the files will be automatically deleted after printing.

If the [Print and Save the Data] key is touched, the files will be saved after printing.

## Batch printing

All files in a folder that have the same user name and password can be printed at once. When the [Multi-File Print] key is touched, it changes into the [Batch Print] key.

1

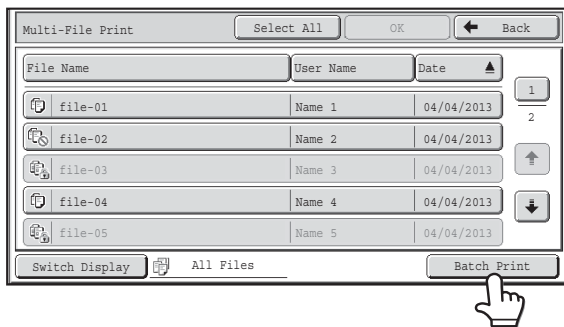

Touch the [Batch Print] key.

2



Touch the [User Name] key.

When user authentication is used, the user name that was used for login is automatically selected.

When "Display only the Files of Logged-in Users" is enabled under System Settings (Administrator): Authority Group List (Document Filing), the user name of the currently logged-in user is selected and other user names cannot be selected.

3

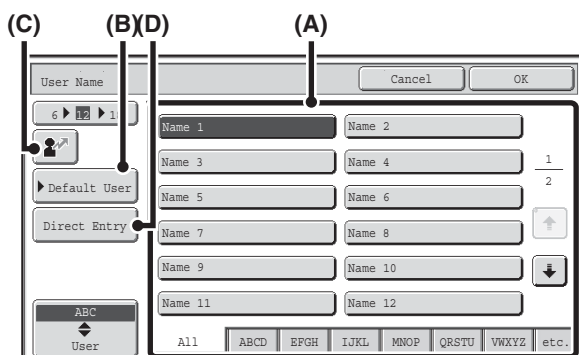

Select the user name.

There are four ways to select the user name:

**(A) Touch the key of the user name.**

The touched user name is highlighted.

If you accidentally select the wrong user name, touch the key of the correct name.

**(B) Touch the [Default User] key.**

The user name can be selected from the factory stored users.

**(C) Touch the [User] key.**

An area for entering the "Registration No." [----] appears in the message display. Enter the "Registration No." set during user registration. This will allow you to select the user name.

**(D) Touch the [Direct Entry] key.**

A text entry screen appears. Directly enter the user name. After selecting the user name, touch the [OK] key.



When [Selection of [All Users] is not allowed.] checkbox and [Selection of [User Unknown] is not allowed.] checkbox are disabled in the system settings (administrator), the [All Users] key and [User Unknown] key can be selected. The [All Users] key can be touched to select all files in the folder (the files of all users). The [User Unknown] key can be touched to select all files in the folder that do not have a user name.

4

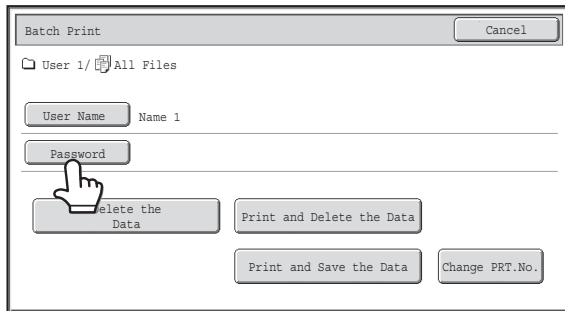

### If a password has been established, touch the [Password] key.

Enter the password with the numeric keys (5 to 8 digits) and touch the [OK] key. Only files that have the same password will be selected.

If you do not wish to enter a password, go to the next step.

5

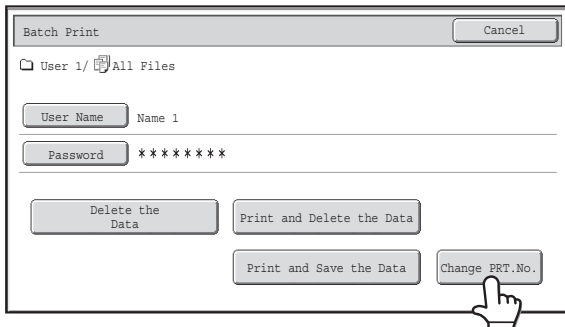

### To set the number of copies, touch the [Change PRT.No.] key.

If you wish to use the number of copies stored with each file, go to step 6.

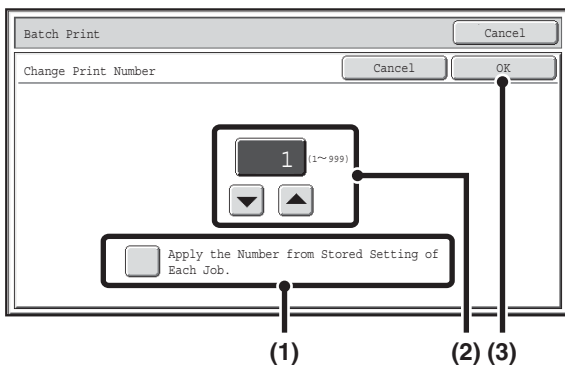

(1) Touch the [Apply the Number from Stored Setting of Each Job] checkbox so that it is not selected () .

(2) Set the number of copies with the   keys.

You can also directly touch the numeric display and change the number with the numeric keys.

(3) Touch the [OK] key.

6

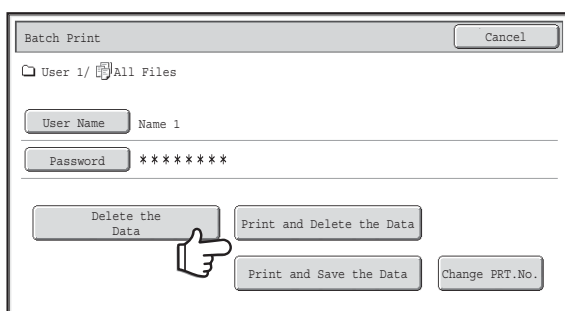

### Touch the [Print and Delete the Data] key or the [Print and Save the Data] key.

If the [Print and Delete the Data] key is touched, the files will be automatically deleted after printing.

If the [Print and Save the Data] key is touched, the files will be saved after printing.

If there are no files that match the search conditions, you will return to the file list screen.



All files that match the current search conditions can be deleted by touching the [Delete the Data] key.

# SENDING A STORED FILE

A file stored by document filing can be retrieved and transmitted whenever needed. The settings used when the file was stored are also stored, and thus the file can be transmitted using those settings. If needed, you can also change the transmission settings to modify the retrieved file.

After selecting the desired file, follow the steps below.

☞ [SELECTING A FILE](#) (page 6-29)

1

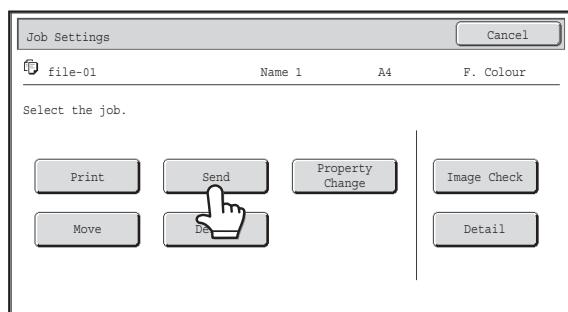

Touch the [Send] key.

2

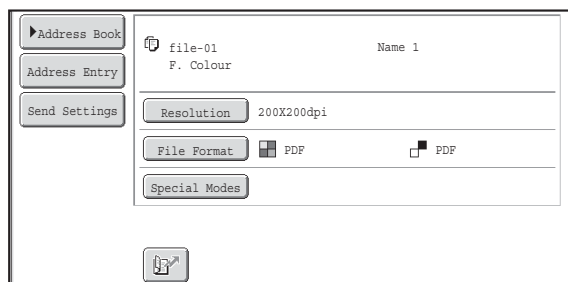

Select transmission settings.

For information on the settings, see "[SEND SETTINGS SCREEN](#)" (page 6-38).

3

Press the [COLOUR START] key or the [BLACK & WHITE START] key.



If you are sending a fax or an Internet fax, only the [BLACK & WHITE START] key can be used.

- A file saved in black and white or greyscale cannot be transmitted in colour.
- A stored print job cannot be transmitted.
- These transmission methods require installation of the corresponding options.
- If any of the following special modes were included in the saved file, the file cannot be transmitted. "Pamphlet Copy", "Covers/Inserts", "Photo Repeat", "Multi-Page Enlargement", "Multi Shot" for copying.
- If any of the following special modes were included in the saved file, the file can be transmitted but the special modes will not be executed. "Margin Shift", "Transparency Inserts", "Book Copy", "Tab Copy", "Stamp", all "Colour Adjustments" menu items, "Centring"
- Depending on the reduction or enlargement ratio used when storing a file, it may not be possible to send the stored file using a selected resolution setting. In this event, try changing the resolution. However, when sending a stored file by Internet fax, transmission may not be possible even if the resolution is changed.

# SEND SETTINGS SCREEN

The keys that appear in the send settings are explained below. For more information on each of the settings, see "[BASE SCREEN OF FAX MODE](#)" (page 4-7) in "4. FACSIMILE" and "[BASE SCREEN](#)" (page 5-9) in "5. SCANNER / INTERNET FAX".

## Example of scan mode

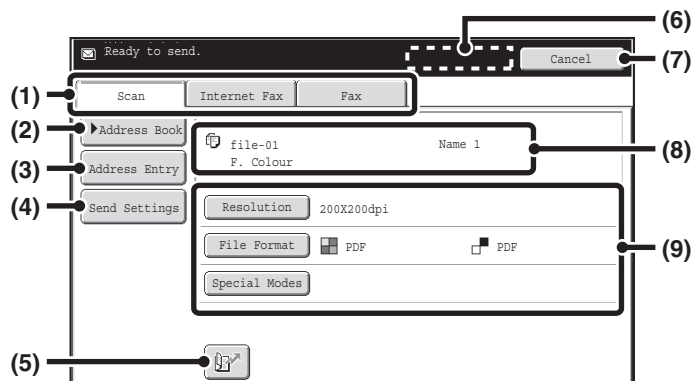

### (1) Send mode tabs

Touch the appropriate tab to select fax mode, scan mode, Internet fax mode, etc.

### (2) [Address Book] key

Touch this key to display the destinations stored in the address book.

### (3) [Address Entry] key or [Sub Address] key

Use this key to directly enter an address when sending a file in scan mode or Internet Fax mode. In fax mode this appears as the "Sub Address" key. Use this key to enter a sub-address and password for F-code communication.

### (4) [Send Settings] key

This key appears in scan mode and Internet fax mode. Touch the key to enter a subject and a file name when performing a transmission. In scan mode, a sender can also be specified.

### (5) key

The 4-digit search number that was assigned to a one-touch key or group key when the key was stored can be entered to specify a destination.

### (6) [Next Address] key

This key appears when at least one address has been entered. Use this key when you are sending a file to multiple destinations.

### (7) [Cancel] key

This returns you to the job settings screen.

### (8) File name / User name display

This shows the icon of the file to be sent, the file name, the user name, and the colour mode (colour/black & white).

### (9) Any of these keys can be touched to change the corresponding settings of the file to be sent. The settings that can be selected vary by mode.

#### • Scan mode

##### [Resolution] key

Use this to select the resolution. A resolution setting higher than the resolution at which the file was stored cannot be selected.

##### [File Format] key

This lets you select the file type, compression ratio, and colour mode.

##### [Special Modes] key

This displays the [Timer] key.

#### • Internet fax mode

##### [Resolution] key

Use this to select the resolution. A resolution setting higher than the resolution at which the file was stored cannot be selected.

##### [File Format] key

Use this to select the file type and compression ratio.

##### [Special Modes] key

This displays the [Timer] and [Transaction Report] keys.

#### • Fax mode

##### [Resolution] key

Use this to select the resolution. A resolution setting higher than the resolution at which the file was stored cannot be selected.

##### [Special Modes] key

This displays the [Timer], [Own Name Select], and [Transaction Report] keys.



# PROPERTIES OF STORED FILES

## FILE PROPERTIES

A protect setting can be selected for files saved with the document filing function. This prevents a file from being moved, or automatically or manually deleted.

Three properties are available for saved files: [Sharing], [Protect], and [Confidential]. When saved with the [Sharing] property, a file is not protected. When saved with the [Protect] or [Confidential] property, a file is protected.

Files saved to the Quick File folder are all saved as [Sharing] files. When a file is saved to the Main folder or a custom folder, [Sharing] or [Confidential] can be selected.

<b>Sharing</b>	A [Sharing] file can be changed to [Protect] or [Confidential] using [Property Change] in the Job Settings.
<b>Protect</b>	"Protect" prevents a file from being moved or deleted. A password cannot be established. The  icon appears with the mode icon in the file key of a protected file.
<b>Confidential</b>	To protect a "Confidential" file, a password is set. (The password must be entered to retrieve the file.) The  icon appears with the mode icon in the file key of a confidential file.

## CHANGING THE PROPERTY

After selecting the desired file, follow the steps below.

 [SELECTING A FILE](#) (page 6-29)

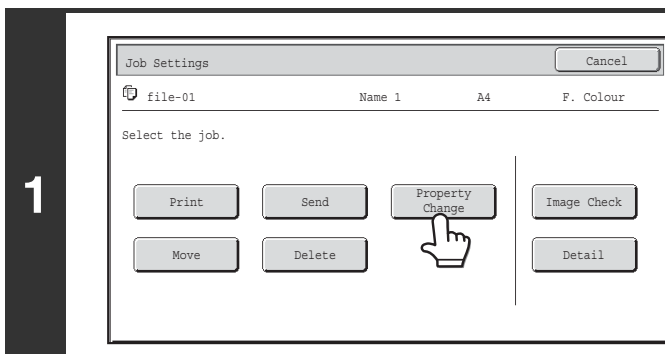

Touch the [Property Change] key.

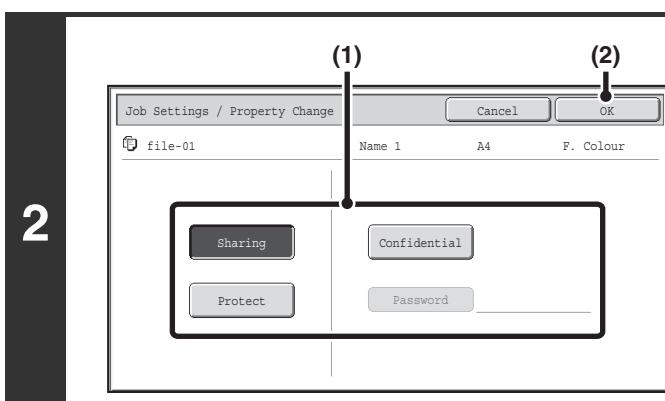

Select the property.

(1) Touch the key of the desired property.

When the [Confidential] key is touched, the [Password] key can be touched.

Touch the [Password] key, enter a password (5 to 8 digits) with the numeric keys, and touch the [OK] key.

(2) Touch the [OK] key.

**Restrictions on changing the property**

- A file that is set to "Sharing" can be changed to "Protect" or "Confidential". However, a "Sharing" file that is saved in the Quick File folder can only be changed to "Protect".
- A file that is set to "Protect" can be changed to "Sharing" or "Confidential". However, a "Protect" file that is saved in the Quick File folder can only be changed to "Sharing".
- A file that is saved in the Quick File folder cannot be changed to "Confidential". If the file is moved to the Main folder or a custom folder, the property can be changed to "Confidential".
- Two properties cannot be selected for a single file.



# MOVING A STORED FILE

Use this procedure to change the location of a file (move a file to a different folder).

After selecting the desired file, follow the steps below.

🔗 [SELECTING A FILE](#) (page 6-29)

1

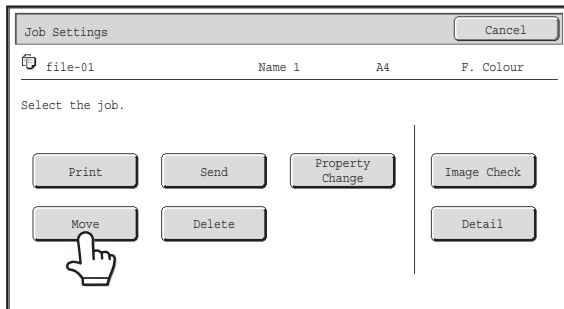

Touch the [Move] key.

2

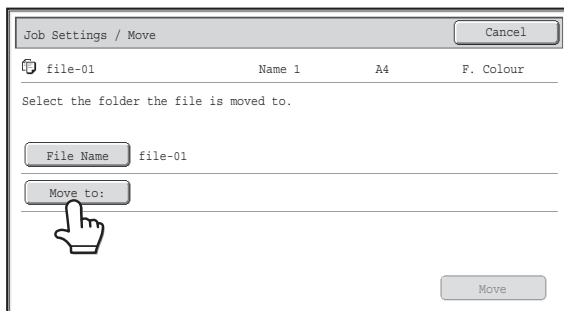

Touch the [Move to:] key.



- A file cannot be moved to the Quick File Folder. With this procedure, the original name is changed and the file is moved to the specified folder. (Unlike the "Save As" command on a computer, the file is not copied to the specified folder with the original file remaining in the original location.)
- To change the file name, touch the [File Name] key.

3

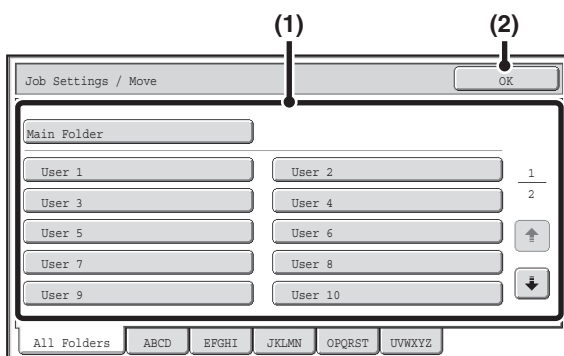

Select the destination folder.

(1) Touch the key of the folder to which you want to move the file.

If a password is set for the selected folder, a password entry screen will appear.

Enter the password with the numeric keys (5 to 8 digits) and touch the [OK] key.

(2) Touch the [OK] key.

The above screen shows the custom folders as an example.

4

Job Settings / Move Cancel

file-01      Name 1      A4      F. Colour

Select the folder the file is moved to.

File Name    file-01

Move to:    User 2

Move

Touch the [Move] key.



A file whose property is "Protect" cannot be moved. To move a protected file, change its property to "Sharing" or "Confidential".

# DELETING A STORED FILE

Stored files that are no longer needed can be deleted.  
Select the file that you wish to delete and touch the [Delete] key.  
🔗 [SELECTING A FILE](#) (page 6-29)

**1**

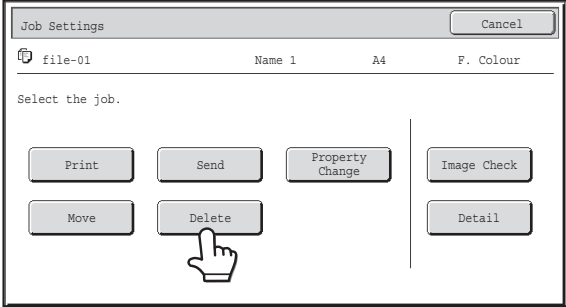

**Touch the [Delete] key.**

**2**

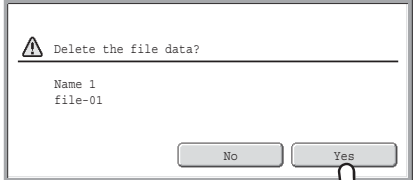

**Check the file and then touch the [Yes] key.**

 A file whose property is "Protect" cannot be deleted. To delete a protected file, change its property to "Sharing" or "Confidential".

# CHECKING AN IMAGE OF A STORED FILE

You can check an image of a file stored using document filing.  
Select the desired file and touch the [Image Check] key.

 [SELECTING A FILE](#) (page 6-29)

 Depending on the size of the image, part of the image may be clipped off in the image check screen on the touch panel.

1

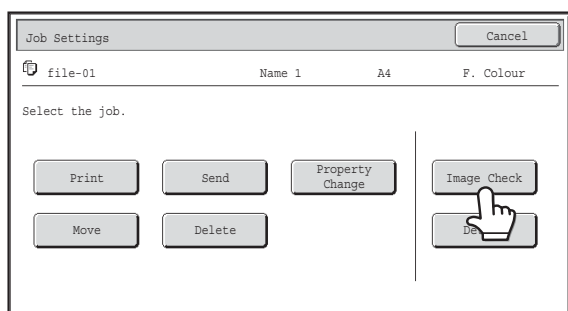

**Touch the [Image Check] key.**

2

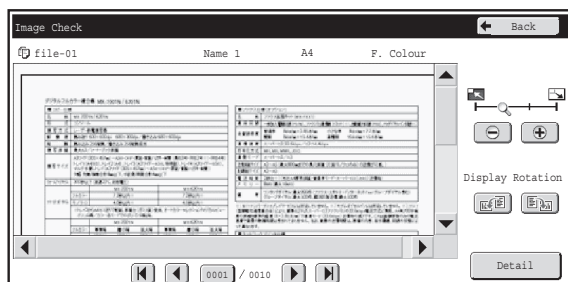

**Check the image of the file.**

For information on each of the items, see "[IMAGE CHECK SCREEN](#)" (page 6-45).

# IMAGE CHECK SCREEN

This section explains the image check screen.

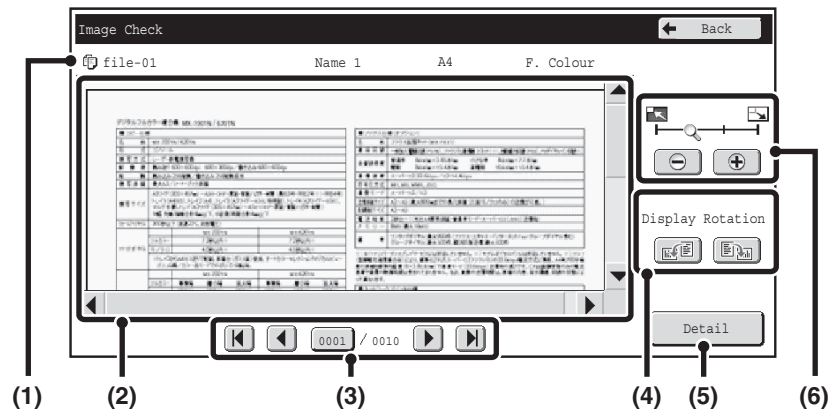

## (1) Information display

This shows information on the displayed image.

## (2) Preview image

This shows an image of the selected file.

If the image is cut off, use the scroll bars at the right and bottom of the screen to scroll the image. Touch a bar and slide it to scroll. (You can also touch the keys to scroll.)

## (3) Change page keys

When there are multiple pages, use these keys to change pages.

- keys: Go to the first or the last page.
- keys: Go to the previous page or the next page.
- Page number display: This shows the total number of pages and the current page number. You can touch the current page number key and enter a number with the numeric keys to go to that page number.

## (4) "Display Rotation" key

This rotates the image right or left by 90 degrees. The rotation applies to all pages in the file, not just the displayed page.



A print file cannot be rotated.

## (5) [Detail] key

This shows the detailed information screen.

[FILE SELECTION SCREEN](#) (page 6-27)

## (6) Display zoom key

Use this to set the zoom ratio of the displayed image. Changes from the left in the order "Full Page", "Twice", "4 Times", "8 Times". The setting applies to all pages in the file, not just the displayed page.



For a print file, only an image of the first page of the file is shown; the displayed page cannot be changed.



A preview image is an image for display on the touch panel. It will differ from the actual print result.

# RETRIEVING AND USING A FILE FROM THE JOB STATUS SCREEN

Files stored using File and Quick File appear as keys in the job status complete screen.

This is convenient when you need to quickly print the saved data of a copy job or quickly send a saved fax to another destination.

1

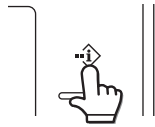

Touch the [JOB STATUS] key ( ).

2

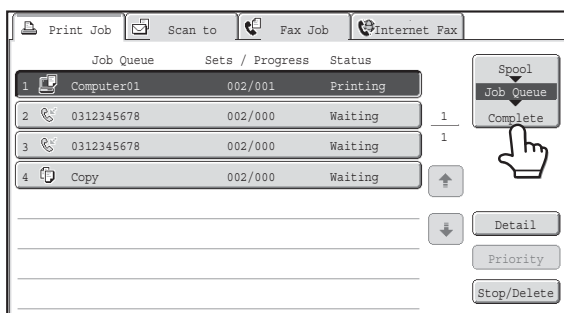

Touch the job status selector key so that [Complete] is highlighted.

3

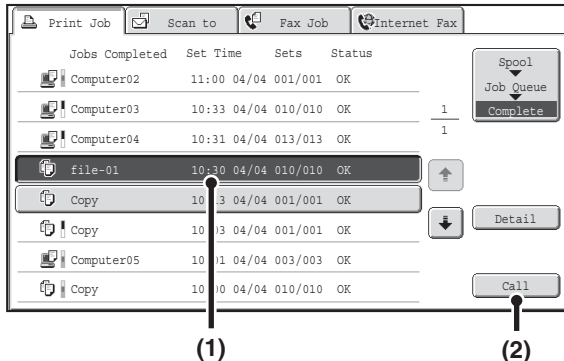

Select the desired file in the completed jobs.

(1) Touch the key of the desired file.

(2) Touch the [Call] key.

The job settings screen appears.

Select and perform the desired operation.

- [JOB SETTINGS SCREEN](#) (page 6-30)
- [PRINTING A STORED FILE](#) (page 6-31)
- [SENDING A STORED FILE](#) (page 6-37)
- [PROPERTIES OF STORED FILES](#) (page 6-39)
- [MOVING A STORED FILE](#) (page 6-41)
- [DELETING A STORED FILE](#) (page 6-43)
- [CHECKING AN IMAGE OF A STORED FILE](#) (page 6-44)



- To view information on a file, select the file and then touch the [Detail] key.
- If user authentication is enabled, and the [Call] key is touched when no users are logged in, the user authentication screen will appear to let you log in.
- When "Display only the Files of Logged-in Users" is enabled under System Settings (Administrator): Authority Group List (Document Filing), it is not possible to reuse a file if its user name does not match the user name of the logged-in user.

# SEARCHING FOR A STORED FILE

When there are many stored files, it may take time to find a file. The search function of document filing mode can be used to find a file quickly.

This section explains how to search for a file or folder on the machine's hard drive.

Searching is possible even when you only know part of the file name or folder name. A folder can also be specified as a search range.

**Example: Only part of a file name is known: "Meeting"**

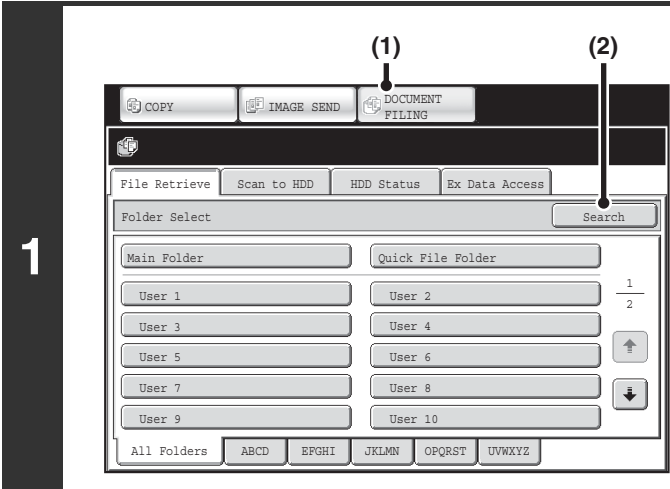
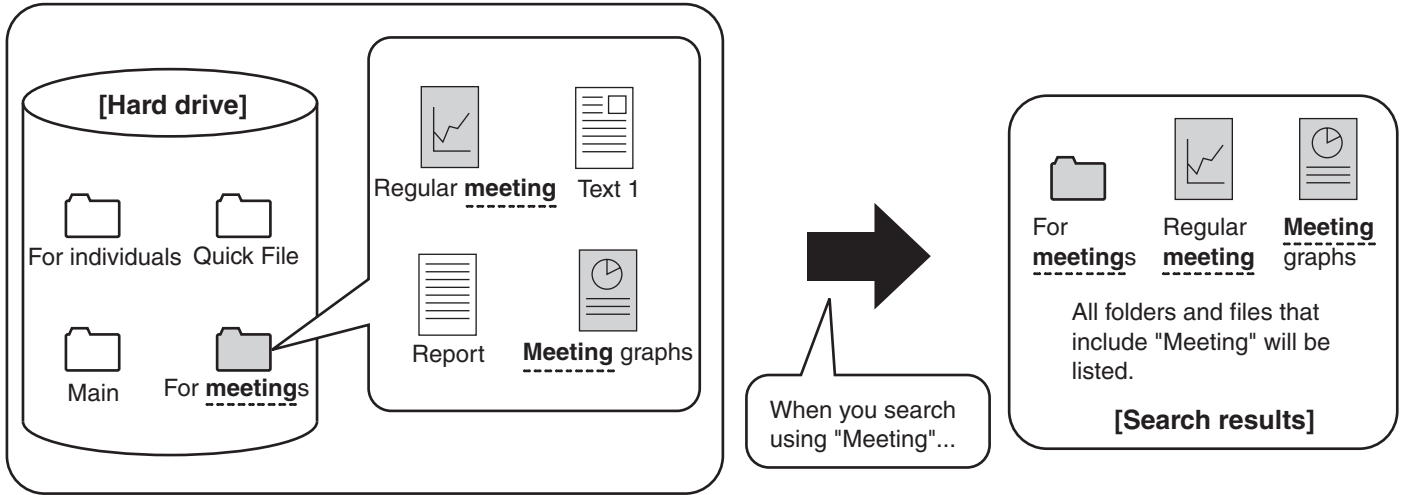

**Open the file search screen.**

- (1) Touch the [DOCUMENT FILING] key.
- (2) Touch the [Search] key.



**Touch the [User Name] key or the [File or Folder Name] key.**

If you know the user name, touch the [User Name] key and go to "Using the user name to search" in step 3.

If you know the file name, touch the [File or Folder Name] key and go to "Using the file name or folder name to search" in step 3.

When "Display only the Files of Logged-in Users" is enabled under System Settings (Administrator): Authority Group List (Document Filing), the user name of the currently logged-in user is selected and other user names cannot be selected.

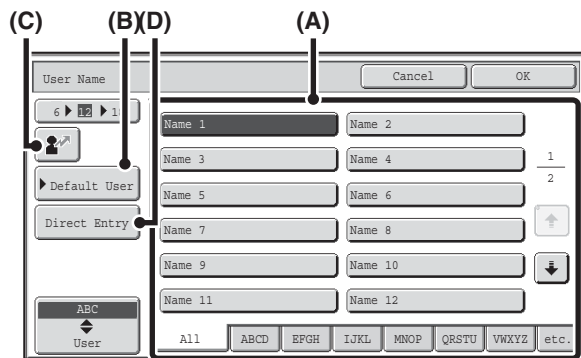

## Using the user name to search

There are four ways to select the user name:

### (A) Touch the key of the user name.

The touched user name is highlighted.

If you accidentally select the wrong user name, touch the key of the correct name.

### (B) Touch the [Default User] key.

The user name can be selected from the factory stored users.

### (C) Touch the key.

An area for entering the "Registration No." [----] appears in the message display. Enter the "Registration No." set during user registration. This will allow you to select the user name.

### (D) Touch the [Direct Entry] key.

A text entry screen appears. Directly enter the user name. Searching is possible even if you only enter the first several letters of the user name.

After selecting the user name, touch the [OK] key.

After the user name is selected, the [Password] key can be touched. To search for files of the selected user name that have a certain password, touch the [Password] key and enter the password.

(It is not possible to search using a password only.)

## Using the file name or folder name to search

Enter the file name or folder name in the text entry screen that appears and touch the [OK] key.



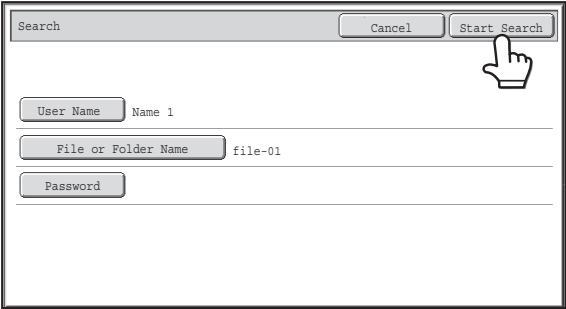

**Touch the [Start Search] key.**

The search results will appear in a screen similar to the following screen. A list of the files that match your search criteria will appear. Select the desired file from the list. The job settings screen will appear.

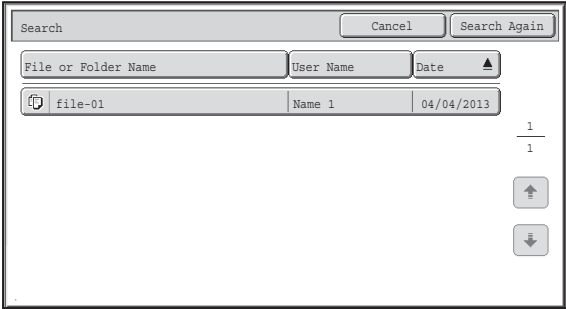

To return to the base screen of document filing mode, touch the [Cancel] key.

To return to the file search screen, touch the [Search Again] key.



- When you search using [File or Folder Name], custom folders that match the search characters will also appear in the list. When a folder key is touched, a list of the files in the folder appears. Touch the desired file in the list.
- You can also use the Web pages to search for a file. Click [Document Operations], [Document Filing], and then [Search] in the Web page menu.

## Searching within a folder

You can specify a folder to restrict the search range to that folder. To search within a specified folder, follow the steps below.

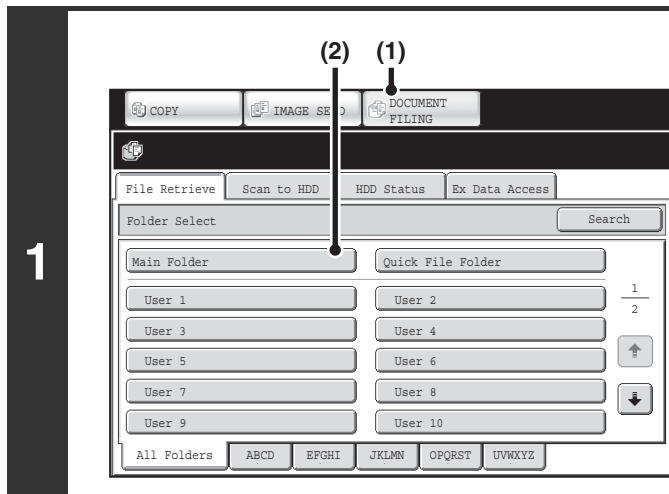

**Open the folder that you wish to search.**

**(1) Touch the [DOCUMENT FILING] key.**

**(2) Touch the key of the folder that you wish to search.**

If a password is set for the selected folder, a password entry screen will appear.

Enter the password with the numeric keys (5 to 8 digits) and touch the [OK] key.

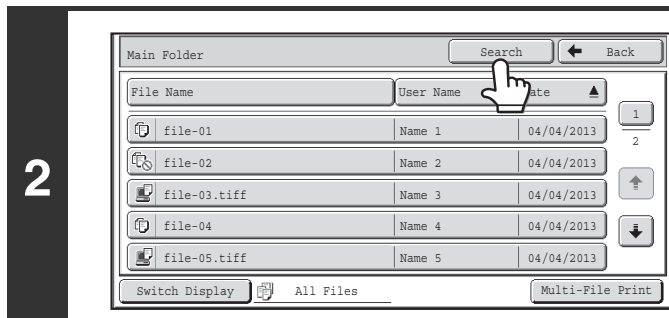

**Touch the [Search] key.**



**Touch the [User Name] key or the [File or Folder Name] key.**

If you know the user name, touch the [User Name] key and go to "[Using the user name to search](#)" in step 4.

If you know the file name, touch the [File or Folder Name] key and go to "[Using the file name or folder name to search](#)" in step 4.

When "Display only the Files of Logged-in Users" is enabled under System Settings (Administrator): Authority Group List (Document Filing), the user name of the currently logged-in user is selected and other user names cannot be selected.

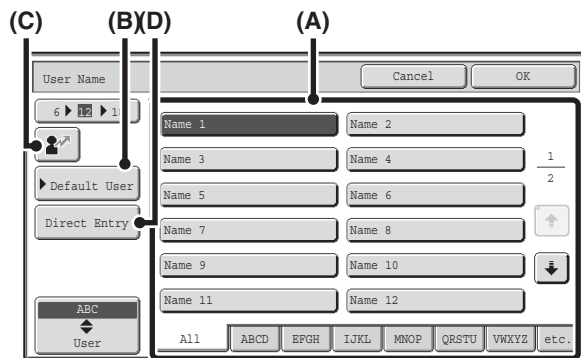

## Using the user name to search

There are four ways to select the user name:

### (A) Touch the key of the user name.

The touched user name is highlighted.

If you accidentally select the wrong user name, touch the key of the correct name.

### (B) Touch the [Default User] key.

The user name can be selected from the factory stored users.

### (C) Touch the key.

An area for entering the "Registration No." [----] appears in the message display. Enter the "Registration No." set during user registration. This will allow you to select the user name.

### (D) Touch the [Direct Entry] key.

A text entry screen appears. Directly enter the user name. Searching is possible even if you only enter the first several letters of the user name.

After selecting the user name, touch the [OK] key.

After the user name is selected, the [Password] key can be touched. To search for files of the selected user name that have a certain password, touch the [Password] key and enter the password.

(It is not possible to search using a password only.)

## Using the file name or folder name to search

Enter the file name in the text entry screen that appears and touch the [OK] key.

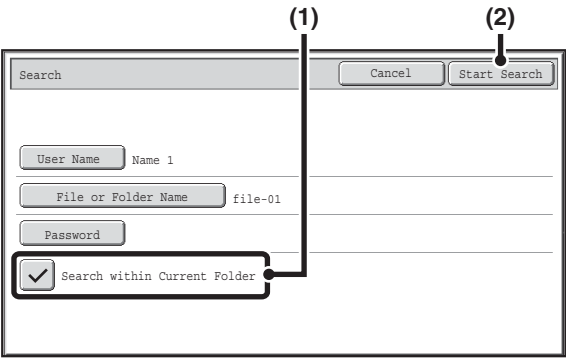

**Start searching.**

- (1) Touch the [Search within Current Folder] checkbox so that it is selected .

To search only files that are in the current folder, select the [Search within Current Folder] checkbox . Use this method to search for a file in a confidential folder.

- (2) Touch the [Start Search] key.

The search results will appear in a screen similar to the following screen. A list of the files that match your search criteria will appear. Select the desired file from the list. The job settings screen will appear.

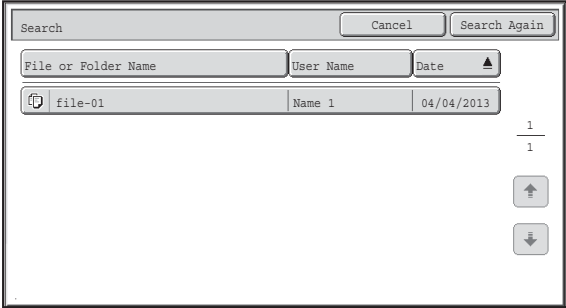

To return to the base screen of document filing mode, touch the [Cancel] key.

To return to the file search screen, touch the [Search Again] key.

# CHAPTER 7

# SYSTEM SETTINGS

This chapter explains the system settings, which are used to configure a variety of parameters to suit the aims and needs of your workplace. The current selections that have been made for the settings can be viewed or printed out. To quickly check where a setting is located in the system settings menu, see "SYSTEM SETTINGS MENU" (page 7-119), "Accessing the System Settings (General)" (page 7-5), or "Accessing the System Settings (Administrator)" (page 7-28). For the system settings for the fax function, see "System Settings for Fax (General) List" (page 7-104) and "System Settings for Fax (Administrator) List" (page 7-110).

## SYSTEM SETTINGS

<b>System Settings</b> .....	7-3
<b>Common Operation Methods</b> .....	7-4

## SYSTEM SETTINGS (GENERAL)

<b>Accessing the System Settings (General)</b> .....	7-5
<b>System Settings (General) List</b> .....	7-6
<b>Total Count</b> .....	7-10
• Job Count .....	7-10
• Device Count .....	7-10
<b>Default Settings</b> .....	7-11
• Clock Adjust .....	7-11
• Keyboard Select .....	7-12
<b>List Print (User)</b> .....	7-12
<b>Paper Tray Settings</b> .....	7-13
• Tray Settings .....	7-13
• Paper Type Registration .....	7-15
• Auto Tray Switching .....	7-15
• Custom Size Registration (Bypass) .....	7-15
<b>Address Control</b> .....	7-16
• Address Book .....	7-16
• Custom Index .....	7-20
• Program .....	7-21
<b>Fax Data Receive/Forward</b> .....	7-22
• I-Fax Settings .....	7-22
<b>Printer Condition Settings</b> .....	7-23
• Printer Default Settings .....	7-23
• PCL Settings .....	7-24
• PostScript Setting .....	7-25
<b>Document Filing Control</b> .....	7-26
<b>USB-Device Check</b> .....	7-27
<b>User Control</b> .....	7-27
• Amend User Information .....	7-27

## SYSTEM SETTINGS (ADMINISTRATOR)

<b>Accessing the System Settings (Administrator)</b> .....	7-28
• When User Authentication is not Enabled .....	7-28
• When User Authentication is Enabled .....	7-29
<b>System Settings (Administrator) List</b> .....	7-31
<b>User Control</b> .....	7-47
• User Authentication Setting .....	7-47
• Other Settings .....	7-48
• User List .....	7-51
• Page Limit Group List .....	7-53
• Authority Group List .....	7-54
• Favourite Operation Group List .....	7-57
• User Count .....	7-59
<b>Energy Save</b> .....	7-61
• Eco Scan Setting .....	7-61
• Power Management Setting .....	7-61
• Power ON/OFF Schedule Setting .....	7-62
<b>Operation Settings</b> .....	7-63
• Other Settings .....	7-63
• MFP Display Pattern Setting .....	7-65
• Customize Key Setting .....	7-65
• Home Screen Settings .....	7-65
• Preview Setting .....	7-67
• Remote Operation Settings .....	7-67
• Soft Keyboard Template Setting .....	7-67
<b>Device Control</b> .....	7-68
• Other Settings .....	7-68
• Original Size Detector Setting .....	7-70
• Disabling of Devices .....	7-71
• Fusing Control Settings .....	7-71
<b>Copy Function Settings</b> .....	7-72
• Initial Status Settings .....	7-72
• Other Settings .....	7-73
• Colour Adjustments .....	7-75

<b>Network Settings</b> .....	<b>7-76</b>
• General Setting .....	7-76
• Connection Type Switching .....	7-77
• Wireless Settings .....	7-77
• NAS Setting .....	7-77
<b>Printer Settings</b> .....	<b>7-78</b>
• Default Settings .....	7-78
• Interface Settings .....	7-79
• Auto Colour Calibration .....	7-80
<b>Image Send Settings</b> .....	<b>7-81</b>
• Operation Settings .....	7-81
• Scan Settings .....	7-85
• I-Fax Settings .....	7-87
<b>Document Filing Settings</b> .....	<b>7-91</b>
• Other Settings .....	7-91
• Document Output Options .....	7-93
• Automatic Deletion of File Settings .....	7-93
<b>List Print (Administrator)</b> .....	<b>7-94</b>
<b>Security Settings</b> .....	<b>7-95</b>
<b>Enable/Disable Settings</b> .....	<b>7-97</b>
<b>Change Administrator Password</b> .....	<b>7-100</b>
<b>Product Key</b> .....	<b>7-100</b>
<b>Data Backup</b> .....	<b>7-101</b>
<b>Storing/Calling of System Settings</b> .....	<b>7-102</b>
<b>Sharp OSA Settings</b> .....	<b>7-103</b>

## SYSTEM SETTINGS FOR FAX

<b>System Settings for Fax (General) List</b> .....	<b>7-104</b>
<b>Address Control</b> .....	<b>7-105</b>
• Address Book .....	7-105
• F-Code Memory Box .....	7-107
<b>Fax Data Receive/Forward</b> .....	<b>7-109</b>
• Fax Settings .....	7-109
<b>System Settings for Fax (Administrator) List</b> ..	<b>7-110</b>
<b>Image Send Settings</b> .....	<b>7-112</b>
• Fax Settings .....	7-112
<b>SYSTEM SETTINGS MENU</b> .....	<b>7-119</b>

# SYSTEM SETTINGS

## System Settings

The system settings are used to configure a variety of parameters to suit the aims and needs of your workplace. The system settings are also used to display or print out the current settings and status of the machine. The system settings allow you to make the machine easier to use.

The system settings consist of settings that are used by general users, and settings that can only be configured by an administrator of the machine. These two groups of settings are distinguished in this manual as follows.

System Settings (General)	System Settings (Administrator) *Login Required
<p>System settings that can be configured by general users (including the administrator). For example, the following settings can be configured:</p> <ul style="list-style-type: none"> <li>• Date and time settings</li> <li>• Paper tray settings (paper size and paper type)</li> <li>• Storing destinations for the fax and scanner functions</li> <li>• Settings related to the printer function</li> <li>• Creating folders for document filing</li> <li>• Displaying the number of pages printed, scanned, and faxed.</li> </ul> <p>For more information, see "<a href="#">SYSTEM SETTINGS (GENERAL)</a>" (page 7-5).</p>	<p>System settings that can be configured by the administrator. To configure these settings, login as an administrator is required. For example, the following settings can be configured:</p> <ul style="list-style-type: none"> <li>• Storing users of the machine</li> <li>• Energy save settings</li> <li>• Settings related to the operation panel</li> <li>• Settings for peripheral devices installed on the machine.</li> <li>• Settings related to the copy function</li> <li>• Network connection settings</li> <li>• Transmission/reception settings for faxes and scanned images</li> <li>• Advanced settings for the document filing function</li> </ul> <p>For more information, see "<a href="#">SYSTEM SETTINGS (ADMINISTRATOR)</a>" (page 7-28).</p>
<b>Settings for general users</b>	<b>Settings for administrators</b>



### • Administrator password

To maintain security, the administrator of the machine should promptly change the password after the machine is purchased. (For the factory default administrator password, see "TO THE ADMINISTRATOR OF THE MACHINE" in the Start Guide.) To change the password, see "[Change Administrator Password](#)" (page 7-100).

\*To ensure a high level of security, change the password at regular intervals.

- The above groupings of "General" and "Administrator" are used as a convenient means of clarifying the functions of the settings. These groupings do not appear in the touch panel.
- For fax settings, see "[SYSTEM SETTINGS FOR FAX](#)" (page 7-104).

### • Web pages

The system settings can also be configured from the Web pages. To configure the system settings from the Web pages, click [System Settings] in the Web page menu.

In addition to the system settings, network and security settings can also be configured in the Web pages. For information on the settings, see Help in the Web pages.

# Common Operation Methods

This section explains special operation methods that are common to all system settings.

Be sure to read this section, as the information is omitted in the explanations of some of the individual settings.

## Example: Address book screen

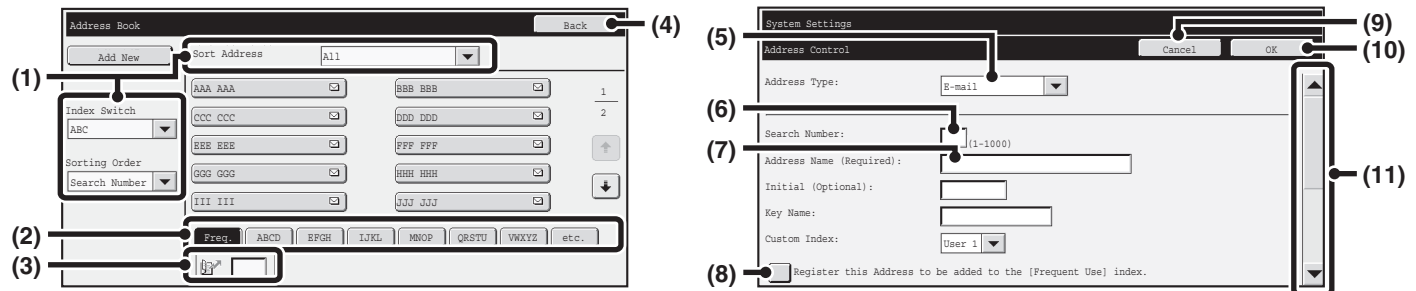

### (1) "Sort"

Use this to select the method of displaying destinations and the index type.

Example: In the "Address Book" screen, the display can be switched between the following three methods:

- Alphabetical/User index
- Display by mode
- Ascending/Descending/Number order

### (2) Index keys

Touch an index key to display the corresponding destinations. The index keys that appear vary depending on the "Sort" setting.

### (3) (Search number entry box)

To search for an address, touch  and enter a search number.

When a user is searched for, the icon changes to .

### (4) [Back] key

Returns you to the previous screen.

### (5) Select box

Touch  to display a list of the items that can be selected. Touch an item in the list to select it.

### (6) Text box (numerical)

Touch this box to enter a number. Numbers are entered with the numeric keys.

If you make a mistake, press the [CLEAR] key () to clear the incorrect number.

### (7) Text box

Touch this box to open a text entry screen. When you have finished entering text in the screen, the text will appear in the text box.

### (8) Checkbox

This switches between  and  each time you touch it. To enable the corresponding setting, touch the checkbox so that a checkmark appears . To disable the setting, clear the checkmark .

Radio buttons () are also used to select settings in this way. (However, radio buttons are used to select a single item out of several.)

### (9) [Cancel] key



This cancels a setting and returns you to the previous screen.

### (10) [OK] key

Touch this to store the current settings.

### (11) Scroll bar

Use this to scroll the screen up and down.

Touch the bar and slide it up or down to move the screen. You can also move the screen up and down with the   keys.



# SYSTEM SETTINGS (GENERAL)

This section describes the system settings that can be configured by general users of the machine.

## Accessing the System Settings (General)

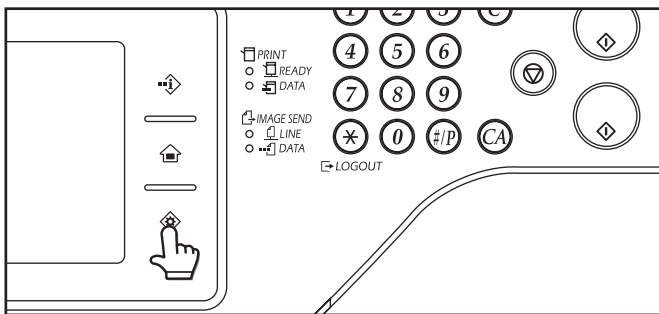

Make sure that the machine is in the standby state and then touch the [SYSTEM SETTINGS] key (◆) on the touch panel.

When the [SYSTEM SETTINGS] key (◆) is touched, the following menu screen appears on the touch panel.

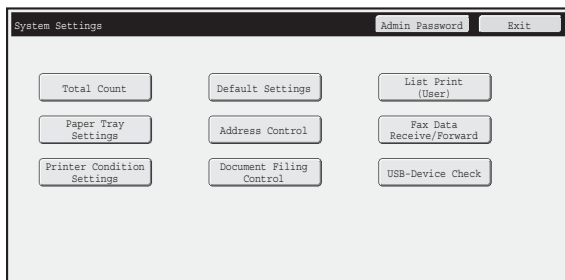

Touch the item in this screen that you wish to configure. For detailed explanations of each of the settings, see the following pages of this chapter.



- To quit the system settings, touch the [Exit] key in the top right corner of the screen.
- For the procedure to follow when user authentication is enabled, see "[USER AUTHENTICATION](#)" (page 1-17) in "1. BEFORE USING THE MACHINE".

# System Settings (General) List

When the system settings are accessed with general rights, the following items appear. For items that can only be accessed with administrator rights, see "[System Settings \(Administrator\) List](#)" (page 7-31).

-  Depending on the machine specifications and peripheral devices installed, it may not be possible to use some settings.
- For explanations of settings related to the fax function, see "[SYSTEM SETTINGS FOR FAX](#)" (page 7-104).

## Total Count

Item	Factory default setting	Page
■ <a href="#">Total Count</a>		7-10
● <a href="#">Job Count</a>	–	7-10
● <a href="#">Device Count</a>	–	7-10

## Default Settings

Item	Factory default setting	Page
■ <a href="#">Default Settings</a>		7-11
● <a href="#">Clock Adjust</a>		7-11
▶ <a href="#">Clock Adjust</a>		
◆ <a href="#">Specify Time Zone</a>	–	
◆ <a href="#">Date &amp; Time Settings</a>	–	
◆ <a href="#">Synchronize with Internet Time Server</a>	Disable	
▶ <a href="#">Daylight Saving Time Setting</a>	Varies depending on country and region	
◆ <a href="#">Select Setting Type</a>	Varies depending on country and region	
◆ <a href="#">Start Time</a>	Varies depending on country and region	
◆ <a href="#">Completing Time</a>	Varies depending on country and region	
◆ <a href="#">Adjustment Time</a>	Varies depending on country and region	
▶ <a href="#">Date Format</a>	Varies depending on country and region	7-12
● <a href="#">Keyboard Select</a>	Varies depending on country and region	

## List Print (User)

Item	Factory default setting	Page
■ <a href="#">List Print (User)</a>		7-12
● <a href="#">All Custom Setting List</a>	–	
● <a href="#">Printer Test Page</a>	–	
● <a href="#">Sending Address List</a>	–	
● <a href="#">Document Filing Folder List*</a>	–	

\* On the MX-2314N, the productivity kit is required.

## Paper Tray Settings

Item	Factory default setting	Page
■ <b>Paper Tray Settings</b>		7-13
● <b>Tray Settings</b>		7-13
▶ Tray 1	Plain, A4 (8-1/2" x 11")	
▶ Tray 2*1,*2	Plain, Auto-AB (Auto-Inch)	
▶ Tray 3*1,*2	Plain, Auto-AB (Auto-Inch)*1 Plain, A4 (8-1/2" x 11")*2	
▶ Tray 4*1,*2	Plain, Auto-AB (Auto-Inch)*1 Plain, A4 (8-1/2" x 11")*2	
▶ Bypass	Plain, Auto-AB (Auto-Inch)	
◆ Select Similar Sizes for Auto Detection	Auto-AB: 216 mm x 330 mm (8-1/2" x 13") Auto-Inch: 8-1/2" x 14"	
● <b>Paper Type Registration</b>	–	7-15
● <b>Auto Tray Switching</b>	Enabled	7-15
● <b>Custom Size Registration (Bypass)</b>	Custom 1: X=432 mm (17"), Y=297 mm (11") Custom 2: X=432 mm (17"), Y=297 mm (11") Custom 3: X=432 mm (17"), Y=297 mm (11")	7-15

\*1 When a paper drawer is installed.

\*2 When a stand/500&2000 sheet paper drawer is installed.

## Address Control

Item	Factory default setting	Page
■ <b>Address Control</b>		7-16
● <b>Address Book</b>	–	7-16
● <b>Storing group keys</b>	User 1	7-18
● <b>Program</b>	–	7-21

## Fax Data Receive/Forward

Item	Factory default setting	Page
■ <b>Fax Data Receive/Forward</b>		7-22
● <b>I-Fax Settings*</b>		7-22
▶ Reception Start	–	
▶ Manual Reception Key in Initial Screen	Enabled	
▶ Forward Received Data	–	

\* When the Internet fax expansion kit is installed. (On the MX-2314N, the productivity kit is required.)

## Printer Condition Settings

Item	Factory default setting	Page
■ <b>Printer Condition Settings</b>		7-23
● <b>Printer Default Settings</b>		7-23
▶ Copies	1	
▶ Orientation	Portrait	
▶ Default Paper Size	A4 (8-1/2" x 11")	
▶ Default Output Tray	Varies depending on the machine configuration	
▶ Default Paper Type	Plain Paper	
▶ Initial Resolution Setting	600dpi (High Quality)	
▶ Disable Blank Page Print	Disabled	
▶ Line Thickness	5	
▶ 2-Sided Print	1-Sided	
▶ Colour Mode	Auto	
▶ N-Up Print	1-Up	
▶ Fit To Page	Enabled	
▶ Output	Varies depending on the machine configuration	
◆ Print per Unit	Enabled	
▶ Quick File	Disabled	
● <b>PCL Settings</b>		7-24
▶ PCL Symbol Set Setting	PC-8	
▶ PCL Font Setting	Internal Font, 0: Courier	
▶ PCL Line Feed Code	0.CR=CR; LF=LF; FF=FF	
▶ Wide A4	Disabled	7-25
● <b>PostScript Setting*</b>		
▶ Print PS Errors	Disabled	
▶ Binary Processing	Disabled	

\* When the PS3 expansion kit is installed.

**Document Filing Control\***

Item	Factory default setting	Page
■ <a href="#">Document Filing Control</a>		<a href="#">7-26</a>

\* On the MX-2314N, the productivity kit is required.

**USB-Device Check**

Item	Factory default setting	Page
■ <a href="#">USB-Device Check</a>	–	<a href="#">7-27</a>

**User Control**

Item	Factory default setting	Page
■ <a href="#">User Control*</a>		<a href="#">7-27</a>
● <a href="#">Amend User Information</a>	–	<a href="#">7-27</a>

\* When user authentication is enabled and the logged-in user does not have the authority to configure the system settings (administrator) (excluding factory default users).

---

---

## Total Count

This function shows the page count in each mode. Touch the [Total Count] key.

## Job Count

This displays or prints out the counts of all jobs.



- A3 (11" x 17") size paper is counted as two sheets.
- Each sheet of paper used for automatic two-sided copying is counted as two pages (A3 (11" x 17") paper is counted as four pages).
- An entered paper size of 384 mm (15-1/8") or larger is counted as two pages.
- Pages printed directly from the machine such as list prints are included in the "Other Prints" count.
- The items displayed (or printed) will vary depending on the machine specifications and peripheral devices installed.

## Device Count

This is used to display or print the counts of the peripheral devices installed on the machine.



- **Document feeder**  
Each sheet is counted as two pages when two-sided scanning is performed.
- **Stapler (when a finisher is installed)**  
Two-position stapling and pamphlet stapling are counted as "2".
- The items displayed (or printed) will vary depending on the machine specifications and peripheral devices installed.

# Default Settings

The default settings for operation of the machine can be configured. Touch the [Default Settings] key and select the settings.

## Clock Adjust

Use this to set the date and time in the machine's built-in clock.

Set the time.

Item	Settings
Specify Time Zone	If your region is ahead of GMT (Greenwich Mean Time), select [+]. If your region is behind GMT, select [-]. Next, specify the time difference between your region and GMT in hours and minutes.
Date&Time Settings	Select and set the year, month, day, hour, and minute.
Synchronize with Internet Time Server	This can be used when the machine is connected to the Internet. The machine's time is automatically adjusted to the time of an Internet time server.

## Daylight Saving Time Setting

Enable daylight saving time.

Item	Settings
Daylight Saving Time Setting	Select whether or not the Daylight Saving Time Setting is enabled. If disabled, the following settings will not be possible.
Select Setting Type	Specify whether the starting and ending day of daylight saving time are to be set using the day of the week or the date.
Start Time	Set the starting time of daylight saving time. Set the starting month. If you selected "Day of the Week" in "Select Setting Type", set the starting week of daylight saving time and then the starting day. If you selected "Date" in "Select Setting Type", set the starting date. Set the hour and minute and the UTC (Coordinated Universal Time) setting.
Completing Time	Set the ending time of daylight saving time in the same way as you set the starting time.
Adjustment Time	Set the time that adjustment will take place when daylight saving time begins.

When this function is used, the time changes at the beginning and end of daylight saving time as indicated in the table below.

Area	Standard time → Daylight saving time	Daylight saving time → Standard time
Europe*	Last Sunday in March, 1:00 to 2:00 AM	Last Sunday in October, 1:00 to 0:00 AM
Australia, New Zealand	Last Sunday in October, 2:00 to 3:00 AM	Last Sunday in March 3:00 to 2:00 AM
Other countries	Select the [Daylight Saving Time Setting] checkbox so that a checkmark <input checked="" type="checkbox"/> appears. The clock setting is configured to normal time plus one hour. When the <input type="checkbox"/> is selected, clock returns to normal time.	

\* In some countries, the starting and ending times of daylight saving time may be different than the times set in the machine.

## Date Format

The format used to print the date on lists and other output can be changed.

Item	Settings
Current Setting	The current time appears in the format set in the date format settings.
Format	Set the order of display of the year, month, and day.
Separator	Select one of three symbols or a blank space for the separator used in the date.
Day-Name Position	Select whether the day name appears before or after the date.
Time Display	Select 12-hour format or 24-hour format for the time. 12-Hour Display: 12:00AM to 11:59AM/12:00 to 11:59PM 24-Hour Display: 00:00 to 24:00



If "[Disabling of Clock Adjustment](#)" (page 7-64) has been enabled in the system settings (administrator), the date and time cannot be set.

## Keyboard Select

The layout of the keyboard that appears in text entry screens can be changed.

The keyboard layouts that can be selected are shown below.

English (US)	English (UK)	Japanese	French	German	Swedish
Norwegian	Finnish	Danish	Russian	Greek	Turkish

## List Print (User)

Lists showing the settings and information stored in the machine can be printed. Touch the [List Print (User)] key and select the settings.

List name	Description
All Custom Setting List	This list shows the hardware status, software status, printer condition settings, paper tray settings, and total counts.
Printer Test Page	This is used to print the PCL Symbol Set List, various font lists, and the NIC page (network interface settings, etc.). <ul style="list-style-type: none"> <li>• PCL Symbol Set List</li> <li>• PCL Internal Font List</li> <li>• PCL Extended Font List</li> <li>• PS Font List</li> <li>• PS Extended Font List</li> <li>• NIC Page</li> </ul>
Sending Address List	Lists can be printed of various addresses stored in the machine. <ul style="list-style-type: none"> <li>• Individual List</li> <li>• Group List</li> <li>• Program List</li> <li>• Memory Box List</li> <li>• All Sending Address List</li> </ul>
Document Filing Folder List*	This shows the folder names for document filing.

\* On the MX-2314N, the productivity kit is required.



- The items that appear will vary depending on the functions that have been added to the machine.
- If "[Prohibit Test Page Printing](#)" (page 7-78) has been enabled in the system settings (administrator), it will not be possible to print a test page.



# Paper Tray Settings

Paper tray and paper type settings are explained in this section. Touch the [Paper Tray Settings] key to configure the settings.

## Tray Settings

These settings specify the paper type, paper size, and functions allowed for each paper tray. When the [Tray Settings] key is touched, a list appears showing the trays and the current settings.

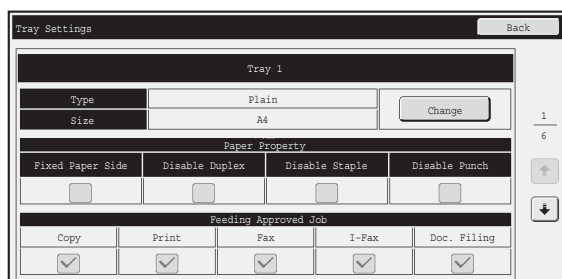

## Settings of each tray

Touch the [Change] key in the above screen to change the settings.

The following settings can be configured.

Item	Description
Type	Select the type of paper that is loaded in the tray. The paper types that can be selected vary by paper tray. For more information, see " <a href="#">Tray Settings</a> " (page 7-14). To store a new paper type, see " <a href="#">Paper Type Registration</a> " (page 7-15).
Size	Select the paper size from the list. The paper sizes that can be selected vary by tray. The sizes that can be selected may also be restricted by the paper type selected above. For more information, see " <a href="#">Tray Settings</a> " (page 7-14). If the desired size does not appear in the list, select [Custom Size] and directly enter the size (only for the bypass tray). For more information, see " <a href="#">Tray Settings</a> " (page 7-14).
Feeding Approved Job	Select the modes that can be used. If there is a function that you do not wish to be used with the selected tray, disable the function. When the "Type" is other than plain paper, recycled paper, coloured paper, or a user type, [Fax] and [Internet Fax] cannot be selected.

-  If the paper size specified here is different from the size of paper that is loaded in a tray, a problem or misfeed may result when printing.  
To change the paper size in a tray, see "1. BEFORE USING THE MACHINE".
- Paper properties such as "Fixed Paper Side" are automatically set when the paper type is selected. The paper tray properties cannot be changed in this screen.
- If "[Disabling of Tray Settings](#)" (page 7-71) has been enabled in the system settings (administrator), the tray settings (except for the bypass tray) cannot be configured.

## Tray Settings

Paper Tray	Paper Type	Size
Tray 1	Plain, Pre-Printed, Recycled, Letter Head, Pre-Punched, Colour, Heavy Paper 1*1, User Type	A3, A4, A4R, A5R, B4, B5, B5R, 216 mm x 330 mm (8-1/2" x 13"), 216 mm x 343 mm (8-1/2" x 13-1/2"), 11" x 17", 8-1/2" x 14", 8-1/2" x 13-2/5" (216 mm x 340 mm), 8-1/2" x 11", 8-1/2" x 11"R, 7-1/4" x 10-1/2"R, 5-1/2" x 8-1/2"R, 8K, 16K, 16KR
Tray 2 (When a paper drawer is installed.)		Auto-AB (A3, A4, A4R, B4, B5, B5R, 216 mm x 330 mm(8-1/2" x 13")), Auto-Inch (11" x 17", 8-1/2" x 14", 8-1/2" x 11", 8-1/2" x 11"R, 7-1/4" x 10-1/2"R)
Tray 3 (When a paper drawer is installed.)		8-1/2" x 13-2/5" (216 mm x 340 mm), 216 mm x 343 mm (8-1/2" x 13-1/2"), 5-1/2" x 8-1/2"R, A5R, 8K, 16K, 16KR
Tray 4 (When a paper drawer is installed.)		
Tray 3 (Stand/500&2000 sheet paper drawer)	Plain, Pre-Printed, Recycled, Letter Head, Pre-Punched, Colour, User Type	A4, 8-1/2" x 11"
Tray 4 (Stand/500&2000 sheet paper drawer)		A4, 8-1/2" x 11"
Bypass	In addition to the paper types of trays 1 to 4, Heavy Paper 2*1, Heavy Paper 3*1, Thin Paper, Glossy Paper	Auto-AB (A3W, A3, B4, A4, A4R, A5R, B5, B5R, 11" x 17", 8-1/2" x 11", 216 mm x 330 mm (8-1/2" x 13")*2, 216 mm x 340 mm (8-1/2" x 13-2/5")*2, 216 mm x 343 mm (8-1/2" x 13-1/2")*2), Auto-Inch (12" x 18", 11" x 17", 8-1/2" x 14"*2, 8-1/2" x 13-2/5" (216 mm x 340 mm)*2, 8-1/2" x 11", 8-1/2" x 11"R, 7-1/4" x 10-1/2"R, 5-1/2" x 8-1/2"R, A3, A4, B4, B5), Size Input-AB (X=140 mm (When a finisher is installed, 148 mm) to 432 mm, Y=90 mm to 297 mm), Size Input-Inch (X=5-1/2" (When a finisher is installed, 5-7/8") to 17", Y=3-5/8" to 11-5/8"), 8K, 16K, 16KR, Custom 1, Custom 2, Custom 3
	Labels	Auto-AB (A4, A4R, B5, B5R), Auto-Inch (8-1/2" x 11", 8-1/2" x 11"R), Custom Size
	Transparency	Auto-AB (A4, A4R), Auto-Inch (8-1/2" x 11", 8-1/2" x 11"R)
	Tab Paper	Auto-AB (A4), Auto-Inch (8-1/2" x 11")
	Envelope	Com-10, Monarch, DL, C5

\*1 Heavy Paper 1:106 g/m<sup>2</sup> to 220 g/m<sup>2</sup> (28 lbs bond to 80 lbs cover) heavy paper

Heavy Paper 2:221 g/m<sup>2</sup> to 256 g/m<sup>2</sup> (80 lbs cover to 140 lbs index) heavy paper

Heavy Paper 3:257 g/m<sup>2</sup> to 300 g/m<sup>2</sup> (140 lbs index to 110 lbs cover) heavy paper

\*2 The size that is automatically detected is set in "[Select Similar Sizes for Auto Detection](#)" in the bypass tray settings screen (see below).

### Select Similar Sizes for Auto Detection

"Select Similar Sizes for Auto Detection" in the bypass tray settings screen is used to select the paper size that is automatically detected from similar sizes when automatic paper size detection takes place.

Select one of two sizes when "Auto-Inch" is set. Select one of three sizes when "Auto-AB" is set.

When paper that is the same size as one of the paper sizes in the settings is placed in the bypass tray, the size that is selected in the settings will be automatically detected.

Auto-AB	216 mm x 330 mm (8-1/2" x 13"), 216 mm x 340 mm (8-1/2" x 13-2/5"), 216 mm x 343 mm (8-1/2" x 13-1/2")
Auto-Inch	8-1/2" x 14", 8-1/2" x 13-2/5" (216 mm x 340 mm)

## Paper Type Registration

Store a paper type when the desired paper type does not appear as a selection or when you wish to create a new set of paper properties.

Up to 7 paper types can be stored.

Item	Description
Type Name	Store any name. The factory default names are "User Type 1" - "User Type 7".
Fixed Paper Side	Enable this setting when paper with a front and reverse side is used.
Disable Duplex	Enable this setting when paper is loaded that cannot be used for two-sided printing.
Disable Staple	Enable this setting when paper is used that cannot be stapled.
Disable Punch	Enable this setting when paper is used that cannot be punched.



The settings that can be selected vary depending on the peripheral devices installed.

## Auto Tray Switching

When a tray runs out of paper during printing, this determines whether or not another tray with the same size and type of paper is automatically selected and printing continues.

## Custom Size Registration (Bypass)

If you frequently use a special non-standard paper size in the bypass tray, you can store that paper size.

Storing the paper size saves you the trouble of setting the size each time you need to use it.

Up to three paper sizes can be stored.

Touch the key ([Custom 1] to [Custom 3]) in which you wish to store or change a paper size. The following screen will appear:

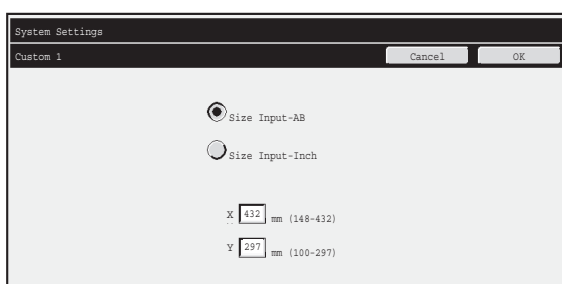

Select whether you wish to enter the size in mm ("Size Input-AB") or inches ("Size Input-Inch"), and then set the X and Y dimensions of the paper.

### "Size Input-AB"

The X dimension can be set to a value from 140 mm (when a finisher is installed, 148 mm) to 432 mm. The factory default setting is 420 mm.

The Y dimension can be set to a value from 90 mm to 297 mm. The factory default setting is 297 mm.

### "Size Input-Inch"

The X dimension can be set to a value from 5-1/2" (when a finisher is installed, 5-7/8") to 17". The factory default setting is 17".

The Y dimension can be set to a value from 3-5/8" to 11-5/8". The factory default setting is 11".

# Address Control

Address Control is used to store, edit, and delete one-touch keys, group keys, program keys, and custom indexes. Touch the [Address Control] key to configure the settings.



- The settings that can be selected vary depending on the peripheral devices installed.
- For explanations of settings related to the fax function, see "[SYSTEM SETTINGS FOR FAX](#)" (page 7-104).

## Address Book

Destinations can be stored in the address book for easy retrieval. When the [Address Book] key is touched, the following screen appears.

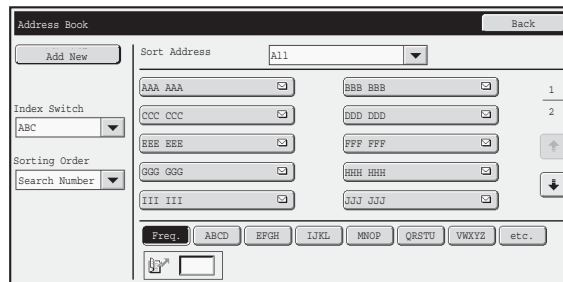

### • [Add New] key

Use this to add a new address.

### • List display

This displays a list of the currently stored addresses. An address can be selected to open an edit/delete screen for the address.

## Storing addresses

Touch the [Add New] key in the above screen to store an address. Up to 1000 addresses can be programmed. For more information, see "[Settings](#)" (page 7-17).



- When "[Disable Registering Destination from Operation Panel](#)" (page 7-82) is enabled in the system settings (administrator) for a function, addresses cannot be stored for that function.
- **To store addresses for Scan to FTP, Scan to Network Folder, and Scan to Desktop...**  
Store Scan to FTP and Scan to Network addresses in the Web pages. Store Scan to Desktop addresses using Network Scanner Tool.

## Editing and deleting addresses

An address can be selected from the list in the above screen to open an edit/delete screen for the address. For more information, see "[Settings](#)" (page 7-17).

Delete an address with the [Delete] key.



- **If you cannot edit or delete a one-touch individual or group key...**  
Individual keys and group keys cannot be edited or deleted in the following situations:
  - The key is used in a reserved transmission or a transmission in progress.
  - The key is included in a group key.
  - The key is included in a program.
  - The key is specified as a forwarding destination in the "[Default Address Setting](#)" (page 7-86) or "Inbound Routing Settings" / "Document Administration Function" (in the Web pages).
  - When "[Disable Registering Destination from Operation Panel](#)" (page 7-82) is enabled.

If the key is used in a reserved transmission or a transmission that is in progress, cancel the transmission or wait until it is completed and then edit or delete the key.

If the key is included in a group, first delete the key from the group and then edit or delete the key.

If the key is specified as a forwarding destination, cancel the forwarding destination setting and then edit or delete the key. If "Disable Registering Destination from Operation Panel" has been enabled, clear this function and then edit or delete the key.

## Settings

Item	Description
<b>Items stored in all modes</b>	
Address Type	Select the type of address to be stored in the address book. <ul style="list-style-type: none"> <li>• E-mail: Store an e-mail address in a one-touch key.</li> <li>• Internet Fax: Store an Internet fax address in a one-touch key.</li> <li>• Direct SMTP: Store a Direct SMTP address in a one-touch key.</li> <li>• Fax: Store a fax number in a one-touch key.</li> <li>• Group: Store multiple addresses as a group for a broadcast transmission.</li> </ul>
Search Number	Set a search number. The lowest available number is automatically entered. To change the number, enter a number from 0001 to 1000. A search number that has already been stored cannot be used.
Address Name	Enter a maximum of 36 characters for the address name.
Initial	Enter up to 10 characters for the initials. The initials you enter here determine the position of the one-touch key in the alphabetical index.
Key Name	Enter the name that you wish to appear in the address book (this is different from the address name).
Custom Index	Select the custom index in which the address will appear.
Register this Address to be added to the [Frequent Use] index.	Frequently used addresses can be stored in the [Frequent Use] index.
<b>Items appearing when an e-mail address is stored</b>	
E-mail Address	Enter an e-mail address (max. 64 characters).
File Format	Specify the format of the file to be generated and the compression mode for black & white mode and colour mode. <ul style="list-style-type: none"> <li>• File Type: Set the format of the file to be generated.</li> <li>• Compression Mode (Black &amp; White): Select the compression mode for black &amp; white transmission.</li> <li>• Compression Ratio (Colour/Greyscale): Select the compression ratio for colour/greyscale transmission.</li> </ul>
<b>Items appearing when an Internet fax address is stored</b>	
I-Fax Address	Enter an Internet fax address (max. 64 characters).
File Format	Compression Mode: Select the compression mode for transmission.
Request Internet Fax Reception Report	Select whether or not you wish to receive a reception report by e-mail after transmission is completed.

Item	Description
<b>Items appearing when a Direct SMTP address is stored</b>	
<ul style="list-style-type: none"> <li>• Direct SMTP Address</li> <li>• Add Hostname or IP Address Too</li> <li>• Hostname or IP Address</li> </ul>	<p>Use these three settings to set an address for Direct SMTP transmission. In many cases, transmission is possible using method (1). A maximum of 64 characters each can be entered in the "Direct SMTP Address" and "Hostname or IP Address" text boxes.</p> <p><b>(1) Using the IPv4 address of the receiving machine in the domain part of the e-mail address</b>            Enter the e-mail address of the receiving machine in the [Direct SMTP Address] text box with the IPv4 address substituted for the domain.            Example:When the e-mail address of the receiving machine is "user@sample_domain.com" and the IPv4 address is "192.168.123.45"            Enter "user@192.168.123.45" in the [Direct SMTP Address] text box.</p> <p><b>(2) Using the host name in the domain part of the e-mail address of the receiving machine</b>            Enter the e-mail address of the receiving machine in the [Direct SMTP Address] text box with the host name substituted for the domain.            Example:When the e-mail address of the receiving machine is "user@sample_domain.com" and the host name is "HOST"            Enter "user@HOST" in the [Direct SMTP Address] text box.</p> <p><b>(3) When the receiving machine is set to only receive e-mail from specific addresses</b>            Enter the specified specific e-mail address in the [Direct SMTP Address] text box. Select the "Add Hostname or IP Address Too" checkbox and enter the host name or IPv4 address of the receiving machine in the [Hostname or IP Address] text box.            Example:When the e-mail address of the receiving machine is "user@sample_domain.com" and the IPv4 address is "192.168.123.45"            Enter "user@sample_domain.com" in the [Direct SMTP Address] text box and enter "192.168.123.45" in the [Hostname or IP Address] text box.</p>
File Format	Compression Mode: Select the compression mode for transmission.
<b>Items appearing when a group is stored</b>	
Address	<ul style="list-style-type: none"> <li>• Address: Select addresses from the address book to be stored in the group.</li> <li>• Direct Entry: An address that is not stored in the address book can be directly entered. Enter the address in the same way as when storing an address for a mode. Note that when an Internet fax address is directly entered, the compression mode and reception report cannot be selected.</li> <li>• Address Review: This displays a list of the selected addresses. Addresses can be deleted from this list if needed.</li> </ul>

## Storing group keys

This section explains the procedure for storing group keys.

1

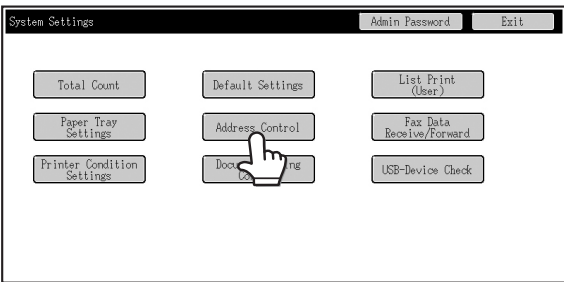

**Touch the [Address Control] key.**

2

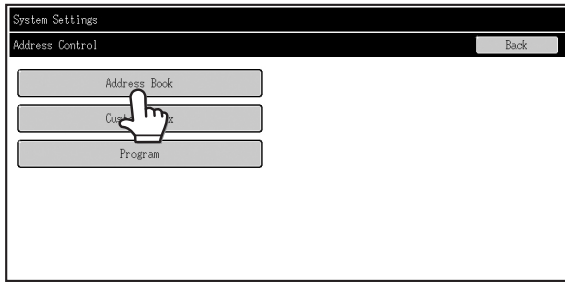

Touch the [Address Book] key.

3

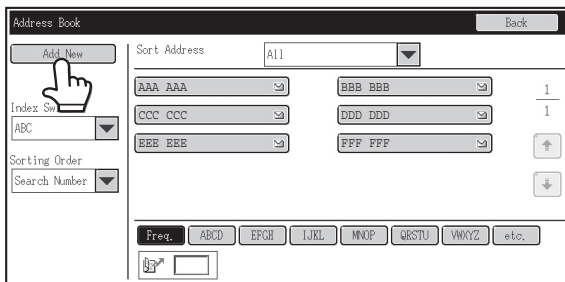

Touch the [Add New] key.

4

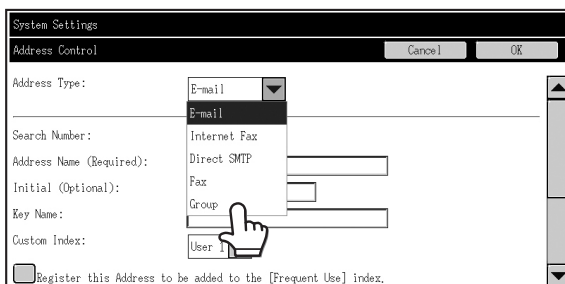

Select "Group" from the [Address Type] list.

5

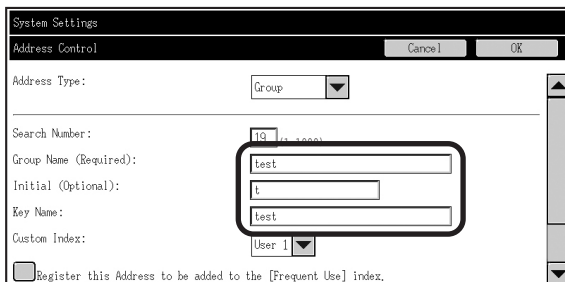

Set the [Group Name], [Initial], and [Key Name] settings. (Other settings can be adjusted as necessary.)

6

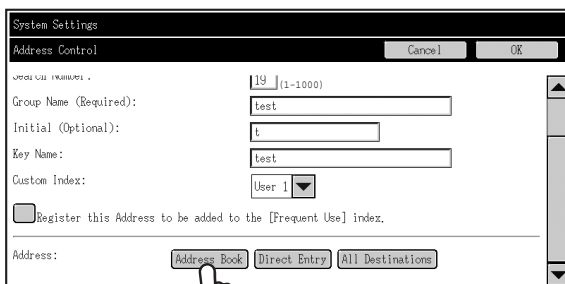

Use the scroll bar to display the lower part of the screen, and touch the [Address Book] key.

Touch the [Direct Entry] key to store an address that is not stored in a one-touch key.

7

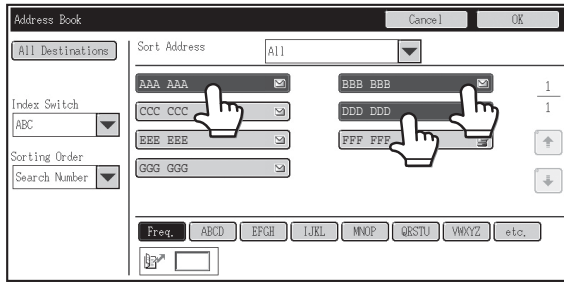

Touch the one-touch keys that you want to add to the group. (Three keys are added in this example.)

8

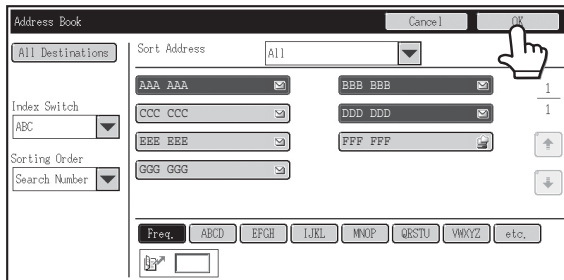

Touch the [OK] key.

9

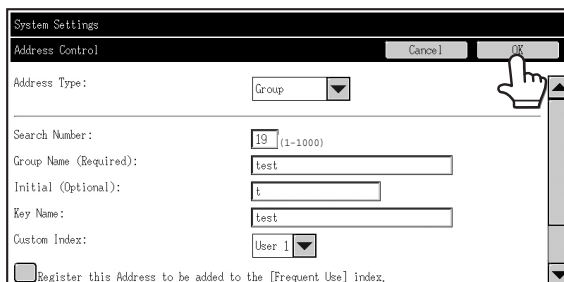

Touch the [OK] key.

10



Touch the [OK] key on the dialog box that appears.

11

The group key registration screen appears. If you want to finish, touch [Cancel] key to return to the previous screen.

The procedure is complete.

## Custom Index

The name of a custom index can be changed for greater ease of use.

Delete the previously entered name and enter a new name (maximum of 6 characters).

The factory default names for the custom indexes are "User 1" to "User 6".



## Program

If you frequently use the same settings and/or functions to transmit to the same destination or destinations, the settings and destinations can be stored in a program. This allows the settings and destinations to be selected by simply selecting the program.

When the [Program] key is touched, the following screen appears.

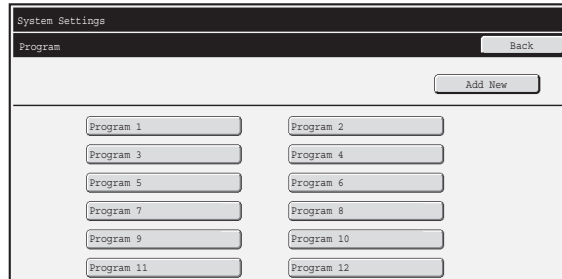

- **[Add New] key**

Use this to add a new program.

- **List display**

This displays a list of the currently stored programs. A program can be selected to open an edit/delete screen for the program.

## Storing a program

Touch the [Add New] key in the above screen to open a registration screen. Up to 48 programs can be stored. For more information, see "[Settings](#)" (page 7-21).



- A timer setting cannot be included in a program.
- At least one one-touch key must be specified in a program or the program cannot be stored.

## Editing and deleting programs

A program can be selected from the list in the above screen to open an edit/delete screen for the program. For more information, see "[Settings](#)" (page 7-21).

Delete a program with the [Delete] key.

## Settings

Item	Description
Program Number	Set the number to be assigned to the program. The lowest available number is automatically entered. To change the number, enter a number from 01 to 48. A number that has already been stored cannot be used.
Program Name	Enter a maximum of 18 characters for the program name.
Address	Select the address(es) to be used in the program from the address book. Up to 500 destinations can be stored in one program.
Address Book screen	This displays a list of the currently stored addresses.
Condition Settings	Touch the [Setup] key to open the condition settings screen for an address.
Address Mode Setting	Select the mode in which the address is used (Internet fax, scan, etc.) When a mode is selected, the settings for that mode appear.
Mode Settings	Frequently used settings can be stored in the same way as when they are selected for a mode.

# Fax Data Receive/Forward

This section explains settings for reception and forwarding. Touch the [Fax Data Receive/Forward] key and configure the settings.



For explanations of settings related to the fax function, see "[SYSTEM SETTINGS FOR FAX](#)" (page 7-104).

## I-Fax Settings

These settings can be configured when the Internet fax expansion kit is installed. (On the MX-2314N, the productivity kit is required.)

### Reception Start

Touch this key to immediately connect to your mail server (POP3 server) and check for received Internet faxes. If you have received Internet faxes, the faxes will be retrieved and printed.



To use this function, POP3 server settings must be configured. Configure these settings in the screen that appears when [Application Settings] - [Internet Fax Settings] is selected in the Web page menu.

### Manual Reception Key in Initial Screen

This displays the [I-Fax Manual Reception] key in the base screen of Internet fax mode.

### Forward Received Data

When the machine cannot print because it is out of paper or out of toner, received faxes can be forwarded to another Internet fax machine.



- To store a forwarding address, see "[Set Address for Data Forwarding](#)" (page 7-89) in the system settings (administrator).
- If forwarding was not successful because the transmission was cancelled or a communication error occurred, the faxes that were to be forwarded will return to the print queue on the machine.
- If the initial pages of a fax were successfully printed, only those pages that were not printed will be forwarded.
- Forwarding is not possible if no faxes were received or a forwarding address is not programmed.
- If "[Hold Setting for Received Data Print](#)" (page 7-82) is enabled, you will be prompted to enter a password. Enter the correct password with the numeric keys.



#### To cancel forwarding...

Touch the [JOB STATUS] key (  ), and then cancel the forwarding job in the same way as a transmission job.

# Printer Condition Settings

The Printer Condition Settings are used to configure basic printer settings and settings for printing from a DOS application. To configure the settings, touch the [Printer Condition Settings] key.

## Printer Default Settings

The default settings are used to set advanced print conditions for printing in an environment where the print driver is not used (such as printing from MS-DOS or from a computer that does not have the provided print driver installed).



When printing using the printer driver, the printer driver settings take precedence over the printer condition settings.

## Settings

Item	Selections
Copies	1 - 999 sets
Orientation	<ul style="list-style-type: none"> <li>• Portrait</li> <li>• Horizontal</li> </ul>
Default Paper Size	A3, B4, A4, B5, A5, 11" x 17", 8-1/2" x 14", 8-1/2" x 13", 8-1/2" x 11", 7-1/4" x 10-1/2", 5-1/2" x 8-1/2", 8k, 16k
Default Output Tray	<ul style="list-style-type: none"> <li>• Centre Tray</li> <li>• Offset Tray*1</li> <li>• Right Tray</li> </ul>
Default Paper Type	Plain Paper, Letter Head, Pre-Printed, Pre-Punched, Recycle Paper, Colour
Initial Resolution Setting	<ul style="list-style-type: none"> <li>• 600 dpi</li> <li>• 600 dpi (High Quality)</li> </ul>
Disable Blank Page Print	<ul style="list-style-type: none"> <li>• <input type="checkbox"/> (Disabled)</li> <li>• <input checked="" type="checkbox"/> (Enabled)</li> </ul>
Line Thickness*2	0-9
2-Sided Print	<ul style="list-style-type: none"> <li>• 1-Sided</li> <li>• 2-Sided (Book)</li> <li>• 2-Sided (Tablet)</li> </ul>
Colour Mode	<ul style="list-style-type: none"> <li>• Auto</li> <li>• Black &amp; White</li> </ul>
N-Up Print*3	<ul style="list-style-type: none"> <li>• 1-Up</li> <li>• 2-Up</li> <li>• 4-Up</li> </ul>
Fit To Page*4	<ul style="list-style-type: none"> <li>• <input checked="" type="checkbox"/> (Use Fit to Page)</li> <li>• <input type="checkbox"/> (Do not use Fit to Page)</li> </ul>
Output	<ul style="list-style-type: none"> <li>• <input checked="" type="checkbox"/> (Use Print per Unit)</li> <li>• <input type="checkbox"/> (Do not use Print per Unit)</li> <li>• Staple Position*1: None, 1 Staple at Back, 2 Staples, 2 Staples (Top)</li> <li>• <input type="checkbox"/> (Use Punch)</li> <li>• <input checked="" type="checkbox"/> (Do not use Punch)</li> </ul>
Quick File	<ul style="list-style-type: none"> <li>• <input type="checkbox"/> (Disabled)</li> <li>• <input checked="" type="checkbox"/> (Enabled)</li> </ul>

\*1 When a finisher is installed.

\*2 This setting is used to adjust the line width of vector graphics (black & white printing only). Except for CAD and other specialized uses, there is normally no need to change this setting. When "0" is selected, all lines are printed at a width of 1 dot.

\*3 Paper sizes that can be used with this function are A3, B4, A4, 11" x 17", 8-1/2" x 14", and 8-1/2" x 11". (This function may not take effect with some print methods.)

\*4 Only effective when printing PDF, JPEG, and TIFF files.

## PCL Settings

This is used to set the symbol sets, fonts, and line feed code used in a PCL environment.

### Settings

Item	Description	Selections
PCL Symbol Set Setting	Specify the symbol set used for printing.	Select from 35 items.
PCL Font Setting	Use this to select the font used for printing.	<ul style="list-style-type: none"> <li>• Internal Font</li> <li>• Extended Font</li> </ul> (List of internal fonts when extended fonts are not installed.)
PCL Line Feed Code	This setting is used to select how the printer responds when a line feed command is received.	<ul style="list-style-type: none"> <li>• 0.CR=CR; LF=LF; FF=FF</li> <li>• 1.CR=CR+LF; LF=LF;FF=FF</li> <li>• 2.CR=CR; LF=CR+LF; FF=CR+FF</li> <li>• 3.CR=CR+LF; LF=CR+LF; FF=CR+FF</li> </ul>
Wide A4	When this is enabled, 80 characters per line can be printed on A4 size paper using a 10-pitch font. (When this setting is disabled, up to 78 characters can be printed per line.)	<ul style="list-style-type: none"> <li>• <input checked="" type="checkbox"/> (Enabled)</li> <li>• <input type="checkbox"/> (Disabled)</li> </ul>

# PostScript Setting

When an error occurs during PostScript printing, these settings determine whether or not an error notice is printed and whether or not the PostScript data is received in binary format.

## Settings

Item	Description	Selections
Print PS Error	When a PS (PostScript) error occurs during PostScript printing, this setting determines whether or not an error notice is printed.	<ul style="list-style-type: none"> <li>• <input checked="" type="checkbox"/> (Enabled)</li> <li>• <input type="checkbox"/> (Disabled)</li> </ul>
Binary Processing	Receive PostScript data in binary format.	<ul style="list-style-type: none"> <li>• <input checked="" type="checkbox"/> (Enabled)</li> <li>• <input type="checkbox"/> (Disabled)</li> </ul>



This setting can be configured when the PS3 expansion kit is installed.

# Document Filing Control

(On the MX-2314N, the productivity kit is required.)

Document Filing Control is used to create, edit, and delete custom folders for document filing. Touch the [Document Filing Control] key to configure the settings.

When the [Document Filing Control] key is touched, the following screen will appear.

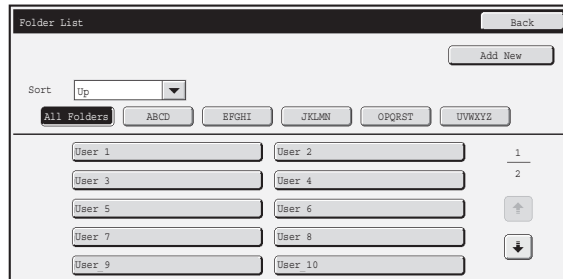

- **[Add New] key**

Use this to add a new custom folder.

- **List display**

This displays a list of the currently configured custom folders. A folder can be selected to open an edit/delete screen for the folder.

## Creating a custom folder

Touch the [Add New] key in the above screen to open a registration screen. Up to 1000 custom folders can be created. For more information, see "[Settings](#)" (page 7-26).

## Editing/deleting a custom folder

A custom folder can be selected from the list in the above screen to open an edit/delete screen for the folder. For more information, see "[Settings](#)" (page 7-26).

Delete a folder with the [Delete] key.



- If the folder has a password, the correct password must be entered before a file can be deleted.
- A folder that contains files cannot be deleted. Either move the files to a different folder or delete them before deleting the folder.

## Settings

Item	Description
Folder Name	Enter a name (maximum of 28 characters) for the custom folder to be created. A name cannot be stored if it is already being used for another folder.
Initial of Folder	Enter up to 10 characters for the initials. The initials you enter here determine the position of the one-touch key in the alphabetical index.
Password of Folder	To set a password for the folder, enter the desired number (5 to 8 digits).
Select User Name	Select the desired user name from the user list.

# USB-Device Check

This lets you check the connection when a USB device is connected to the machine. Touch the [USB-Device Check] key to check the connection.



The status of a USB device that is not compatible with the machine will not appear.

# User Control

This section explains settings for user control. Touch the [User Control] key to configure the settings.



- User Control settings can only be configured when "[User Authentication Setting](#)" (page 7-47) is enabled.
- Depending on the user that logged in, it may not be possible to use the settings below.

# Amend User Information

The information of the currently logged in user can be edited.

## Settings

Item	Description
User Name	Edit the name of the user (max. 32 characters). This user name is used as the key name in the login screen, the document filing user name, and the sender name. (The user name must be unique.)
Initial	Edit the initials (maximum of 10 characters). The initials determine where the user name will appear in the user name list.
Index	Select the desired custom index. The custom index names are the same as those in the address book.
Login Name	This cannot be edited.
Password	Enter the password used for user authentication by login name and password (1 to 32 characters). (The password can be omitted.)
My Folder	This cannot be edited.
E-mail Address	This cannot be edited.
Authentication Settings	This cannot be edited.
Pages Limit Group	This cannot be edited.
Authority Group	This cannot be edited.
Favourite Operation Group	The favourite operation group that will be applied at login appears. Check with your administrator for the settings of the Favourite Operation Groups.
User Number	This cannot be edited.
Deleting an account	This cannot be edited.



The items that appear will vary depending on the user authentication method that is enabled.

# SYSTEM SETTINGS (ADMINISTRATOR)

This section explains the system settings that are configured by the administrator of the machine.

## Accessing the System Settings (Administrator)

To access the system settings (administrator), the administrator must log in as explained below.

### When User Authentication is not Enabled

When "User Authentication Setting" (page 7-47) is not enabled, follow the procedure below to log in.

1

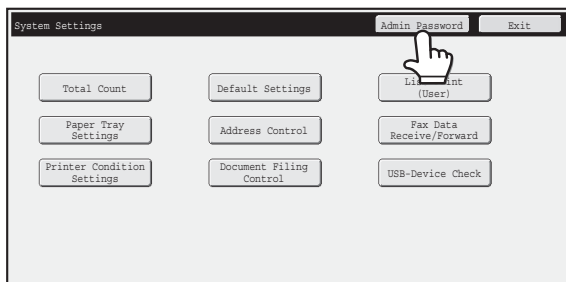

Touch the [Admin Password] key.

2

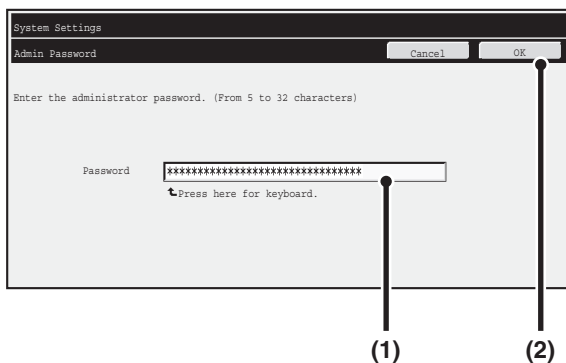

Log in.

- (1) Touch the [Password] text box and enter the administrator password.
- (2) Touch the [OK] key.



This completes the administrator login procedure. The system settings (administrator) can be used.



- User authentication is initially disabled (factory default setting).

- **To logout...**

Touch the [Logout] key in the top right corner of the screen. You can also touch the [Exit] key to quit the system settings. (If Auto Clear activates, logout will automatically take place.)



# When User Authentication is Enabled

When "User Authentication Setting" (page 7-47) is enabled, follow the procedure below to log in.

 When auto login is enabled, the login screen will not appear.

## When user authentication is by login name and password (and e-mail address)

 Administrator login is performed in the user selection screen. For more information on the login procedure when user authentication is enabled, see "USER AUTHENTICATION" (page 1-17) in "1. BEFORE USING THE MACHINE".

1

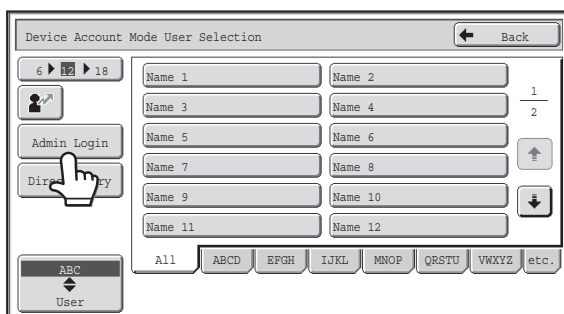

Touch the [Admin Login] key.

2

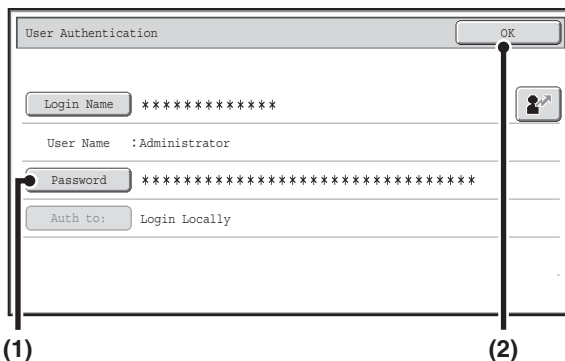

Log in.

(1) Touch the [Password] key.

Enter the administrator password in the administrator password entry screen.

(2) Touch the [OK] key.



- If login name / password / e-mail address is selected for the authentication method, the [E-mail Address] key will appear below the "User Name".
- For the factory default administrator password, see "TO THE ADMINISTRATOR OF THE MACHINE" in the Start Guide.
- This completes the administrator login procedure. The system settings (administrator) can be used.

## Login by user number



### Touch the [Admin Login] key.

Enter the administrator password in the administrator password entry screen.

This completes the administrator login procedure. The system settings (administrator) can be used.

- In addition to login by touching the [Admin Login] key, the system settings (administrator) can also be accessed when login is performed by selecting a user with administrator rights from the user list or by entering a user number with administrator rights. For more information on login procedures when user authentication is enabled, see "[USER AUTHENTICATION](#)" (page 1-17) in "1. BEFORE USING THE MACHINE".
- **To logout...**  
Press the [LOGOUT] (⊗) key. (Except when entering a fax number.)  
(If Auto Clear activates, logout will automatically take place.)

# System Settings (Administrator) List

The system settings that appear following administrator login are shown below. The default setting for each item is also shown.



- Depending on the machine specifications and peripheral devices installed, it may not be possible to use some settings.
- For information on the general settings, see "[System Settings \(General\) List](#)" (page 7-6).
- For explanations of settings related to the fax function, see "[SYSTEM SETTINGS FOR FAX](#)" (page 7-104).

## User Control

Item	Factory default setting	Page
■ <b>User Control</b>		<a href="#">7-47</a>
● <a href="#">User Authentication Setting</a>		<a href="#">7-47</a>
▶ <a href="#">User Authentication</a>	Disabled	<a href="#">7-47</a>
▶ <a href="#">Authentication Method Setting</a>	Authenticate a User by Login Name and Password	<a href="#">7-47</a>
▶ <a href="#">Device Account Mode Setting</a>	Disabled	<a href="#">7-47</a>
● <a href="#">Other Settings</a>		<a href="#">7-48</a>
▶ <a href="#">Actions when the Limit of Pages for Output Jobs</a>	Job is Completed even when the Limit of Pages is Reached	<a href="#">7-48</a>
▶ <a href="#">The Number of User Name Displayed Setting</a>	12	<a href="#">7-48</a>
▶ <a href="#">A Warning when Login Fails</a>	Disabled	<a href="#">7-48</a>
▶ <a href="#">Disabling of Printing by Invalid User</a>	Disabled	<a href="#">7-48</a>
▶ <a href="#">Automatically print stored jobs after login<sup>*3</sup></a>	Disabled	<a href="#">7-48</a>
▶ <a href="#">Default Network Authentication Server Setting</a>	–	<a href="#">7-48</a>
▶ <a href="#">Perform LDAP server access control.</a>	Disabled	<a href="#">7-49</a>
▶ <a href="#">Display Usage Status after Login</a>	–	<a href="#">7-50</a>
▶ <a href="#">User Information Print</a>	–	<a href="#">7-50</a>
● <a href="#">User List</a>	–	<a href="#">7-51</a>
● <a href="#">Page Limit Group List</a>	–	<a href="#">7-53</a>
● <a href="#">Authority Group List</a>	–	<a href="#">7-54</a>
● <a href="#">Favourite Operation Group List<sup>*1</sup></a>	–	<a href="#">7-57</a>
▶ <a href="#">Favourite Operation Group Registration<sup>*1</sup></a>	–	<a href="#">7-57</a>
▶ <a href="#">My Menu List<sup>*1</sup></a>	–	<a href="#">7-58</a>
● <a href="#">User Count</a>	–	<a href="#">7-59</a>
● <a href="#">Card Setting<sup>*2</sup></a>	–	<a href="#">7-60</a>
▶ <a href="#">Card Reader Device Registration</a>	–	<a href="#">7-60</a>

\*1 This cannot be set on the machine. Set this in "User Control" in the Web pages.

\*2 When the HID card reader is available.

\*3 On the MX-2314N, the productivity kit is required.

## Energy save

Item	Factory default setting	Page
■ <b>Energy Save</b>		7-61
● <a href="#">Eco Scan Setting</a>	Enabled	7-61
● <a href="#">Power Management Setting</a>		7-61
▶ <a href="#">Toner Save Mode</a>		7-61
◆ <a href="#">Print</a>	Disabled	
▶ <a href="#">Preheat Mode Setting</a>	11 min.	7-61
◆ <a href="#">Turn off Panel Display during pre-heat mode</a>	Enabled	
▶ <a href="#">Auto Power Shut-Off</a>	Enabled	7-61
▶ <a href="#">Auto Power Shut-Off Timer</a>	Fix transition time.	7-61
◆ <a href="#">Display Message When Extending Transition Time to Preheat/Auto Power Shut-Off Mode</a>	Disabled	
▶ <a href="#">Sleep Mode Power Level</a>	Low Power	7-62
● <a href="#">Power ON/OFF Schedule Setting*</a>	-	7-62

\* This cannot be set on the machine. Set this in the system settings in the Web pages.

## Operation Settings

Item	Factory default setting	Page
■ <b>Operation Settings</b>		7-63
● <a href="#">Other Settings</a>		7-63
▶ <a href="#">Keys Touch Sound</a>	Middle	7-63
◆ <a href="#">Key Touch Sound at Initial Point</a>	Disabled	
▶ <a href="#">Auto Clear Setting</a>	60 sec.	7-63
◆ <a href="#">Cancel Timer</a>	Disabled	
▶ <a href="#">Message Time Setting</a>	6 sec.	7-63
▶ <a href="#">Display Language Setting</a>	Varies depending on country and region	7-63
▶ <a href="#">Default Display Settings</a>	Off	7-63
▶ <a href="#">Disabling of Job Priority Operation</a>	Disabled	7-63
▶ <a href="#">Disabling of Bypass Printing</a>	Disabled	7-63
▶ <a href="#">Key Operation Setting</a>	0.0 sec.	7-63
◆ <a href="#">Disable Auto Key Repeat</a>	Disabled	
▶ <a href="#">Disabling of Clock Adjustment</a>	Disabled	7-64
▶ <a href="#">Disabling of Covers/Inserts Mode</a>	Disabled	7-64
▶ <a href="#">Set Keyboard Priority</a>	Varies depending on country and region	7-64
▶ <a href="#">Initial Original Count Setting</a>	All disabled	7-64
● <a href="#">MFP Display Pattern Setting</a>	Pattern 1	7-65

Item	Factory default setting	Page
● <a href="#">Customize Key Setting</a> <sup>*1</sup>		
▶ Copy		
◆ Customize 1	File	7-65
◆ Customize 2	Quick File	
◆ Customize 3	–	
▶ Scan		
◆ Customize 1	Address Review	7-65
◆ Customize 2	File	
◆ Customize 3	Quick File	
▶ Internet Fax <sup>*2, 5</sup>		
◆ (Same as Scan)		
▶ Fax <sup>*3</sup>		
◆ (Same as Scan)		
▶ USB Memory Scan		
◆ Customize 1	–	
◆ Customize 2	–	
◆ Customize 3	–	
▶ Data Entry <sup>*4</sup>		
◆ (Same as Scan)		
● <a href="#">Home Screen Settings</a> <sup>*1</sup>	–	7-65
▶ <a href="#">My Menu Settings</a> <sup>*1</sup>	–	7-66
● <a href="#">Preview Setting</a> <sup>*5</sup>		
▶ Default Preview	All disabled	7-67
▶ Default Preview Display		
◆ Copy	Full Page	
◆ Image Send	Scan Send: Full Page Internet Fax Send: Full Page Fax Send: Full Page Data Entry: Full Page USB Memory: Full Page Reception Data: Twice Memory Box: Twice	
◆ Doc. Filing	Image Check: Twice Scan to HDD: Full Page	
▶ Received Data Image Check Setting	Disabled	
▶ Default List/Thumbnail Display	List	
● <a href="#">Remote Operation Settings</a>		
▶ Remote Software Operation		7-67
◆ Operational Authority	Prohibited	
◆ View Password Entry Screen	Display in Both PC and MFP	

Item	Factory default setting	Page
▶ Operation from Specified PC		7-67
◆ Operational Authority	Prohibited	
◆ Hostname or IP Address of PC	–	
◆ View Password Entry Screen	Display in Both PC and MFP	
▶ Operation by User who Has Password		
◆ Operational Authority	Prohibited	
◆ View Password Entry Screen	Display in Both PC and MFP	
● <a href="#">Soft Keyboard Template Setting</a>	–	7-67
● <a href="#">Cookie Setting</a>	Not stored	7-67

\*1 This cannot be set on the machine. Set this in the system settings in the Web pages.

\*2 When the Internet fax expansion kit is installed.

\*3 When the facsimile expansion kit is installed.

\*4 When the application integration module is installed.

\*5 On the MX-2314N, the productivity kit is required.

## Device Control

Item	Factory default setting	Page
■ <b>Device Control</b>		7-68
● <a href="#">Other Settings</a>		7-68
▶ <a href="#">Original Feeding Mode</a>	All Disabled	7-68
▶ <a href="#">Auto Paper Selection Setting</a>	Plain Paper	7-68
▶ <a href="#">Tandem Connection Setting</a>		7-68
◆ IP Address of Slave Machine	0.0.0.0	
◆ Port Number	50001	
◆ Disabling of Master Machine Mode	Disabled	
◆ Disabling of Slave Machine Mode	Disabled	
▶ <a href="#">Detect Standard in Auto Colour Mode</a>	3	7-68
▶ <a href="#">Registration Adjustment</a>		7-68
▶ <a href="#">Optimization of a Hard Disk*1</a>	–	7-68
▶ <a href="#">Fusing Cleaning Mode</a>	–	7-68
▶ <a href="#">Clear All Job Log Data*1</a>	–	7-69
● <a href="#">Original Size Detector Setting</a>		7-70
▶ Original Detection Size Combination	Varies depending on country and region	
▶ Cancel Detection at Document Glass	Disabled	
● <a href="#">Disabling of Devices</a>		7-71
▶ <a href="#">Disabling of Document Feeder*1</a>	Disabled	7-71
▶ <a href="#">Disabling of Duplex</a>	Disabled	7-71
▶ <a href="#">Disabling of Optional Paper Drawer*2</a>	Disabled	7-71

Item	Factory default setting	Page
▶ Disabling of Tray Settings	Disabled	7-71
▶ Disabling of Finisher*3	Disabled	7-71
▶ Disabling of Offset	Disabled	7-71
▶ Disabling of Stapler*3	Disabled	7-71
▶ Disabling of Punch*4	Disabled	7-71
▶ Disabling of Colour Mode*5	Disabled	7-71
● Fusing Control Settings	60 - 89g/m <sup>2</sup> (16 - 23 lbs.)	7-71

\*1 On the MX-2314N, the productivity kit is required.

\*2 When a paper drawer is installed.

\*3 When a finisher is installed.

\*4 When a punch module is installed.

\*5 When a colour-related problem has occurred.

## Copy Function Settings

Item	Factory default setting	Page
■ Copy Function Settings		7-72
● Initial Status Settings		7-72
▶ Colour Mode	Full Colour	
▶ Paper Tray	Varies depending on the machine configuration	
▶ Exposure Type	Auto	
▶ Copy Ratio	100%	
▶ 2-Sided Copy	1-Side to 1-Side	
▶ Output	–	
● Other Settings		7-73
▶ Copy Exposure Adjustment		7-73
◆ Colour	5	
◆ Black & White	5	
▶ Rotation Copy Setting	Enabled	7-73
▶ Add or Change Extra Preset Ratios	–	7-73
▶ Setting a Maximum Number of Copies	999	7-73
▶ Initial Margin Shift Setting		7-73
◆ Side 1	10 mm (1/2")	
◆ Side 2	10 mm (1/2")	
▶ Erase Width Adjustment		7-73
◆ Edge Clearance Width	10 mm (1/2")	
◆ Centre Clearance Width	10 mm (1/2")	

Item	Factory default setting	Page
▶ <a href="#">Card Shot Settings</a>		
◆ <a href="#">Original Size</a>	X: 86 mm (3-3/8"), Y: 54 mm (2-1/8")	<a href="#">7-73</a>
◆ <a href="#">Fit to Page</a>	Disabled	
▶ <a href="#">Initial Tab Copy Setting</a>	10 mm (1/2")	<a href="#">7-73</a>
▶ <a href="#">Disabling Deletion of Job Programs</a>	Disabled	<a href="#">7-74</a>
▶ <a href="#">Disabling of Bypass-Tray in Duplex Copy</a>	Disabled	<a href="#">7-74</a>
▶ <a href="#">Disabling of Auto Paper Selection</a>	Disabled	<a href="#">7-74</a>
▶ <a href="#">Auto Selection Setting of Tray that is Supplied the Paper</a>	Disabled	<a href="#">7-74</a>
▶ <a href="#">B/W 600dpi x 600dpi Scanning Mode for Document Feeder</a>	Disabled	<a href="#">7-74</a>
▶ <a href="#">B/W Quick Scan from Document Glass</a>	Enabled	<a href="#">7-74</a>
● <a href="#">Colour Adjustments</a>		<a href="#">7-75</a>
▶ <a href="#">Initial Colour Balance Setting</a>	Factory default state	<a href="#">7-75</a>
▶ <a href="#">Auto Colour Calibration</a>	–	<a href="#">7-75</a>

## Network Settings

Item	Factory default setting	Page
■ <a href="#">Network Settings</a>		<a href="#">7-76</a>
● <a href="#">General Setting</a> <sup>*1</sup>		<a href="#">7-76</a>
▶ <a href="#">IPv4 Settings</a>	DHCP	<a href="#">7-76</a>
▶ <a href="#">IPv6 Settings</a>	Disabled	<a href="#">7-76</a>
▶ <a href="#">Enable TCP/IP</a>	Enabled	<a href="#">7-76</a>
▶ <a href="#">Enable NetWare</a>	Disabled	<a href="#">7-76</a>
▶ <a href="#">Enable EtherTalk</a>	Disabled	<a href="#">7-76</a>
▶ <a href="#">Enable NetBEUI</a>	Disabled	<a href="#">7-76</a>
▶ <a href="#">Reset the NIC</a>	–	<a href="#">7-76</a>
▶ <a href="#">Ping Command</a>	–	<a href="#">7-76</a>
● <a href="#">Connection Type Switching</a> <sup>*1</sup>		<a href="#">7-77</a>
● <a href="#">Wireless Settings</a> <sup>*1</sup>		<a href="#">7-77</a>
● <a href="#">NAS Setting</a> <sup>*2, 3</sup>		<a href="#">7-77</a>

\*1 Depending on your machine specifications, only the items under "General Setting" will be displayed.

\*2 This cannot be set on the machine. Set this in the system settings in the Web pages.

\*3 On the MX-2314N, the productivity kit is required.



## Printer Settings

Item	Factory default setting	Page
■ <b>Printer Settings</b>		7-78
● <b>Default Settings</b>		7-78
▶ Prohibit Notice Page Printing	Enabled	7-78
▶ Prohibit Test Page Printing	Disabled	7-78
▶ A4/Letter Size Auto Change	Varies depending on country and region	7-78
▶ <b>Print Density Level</b>		7-78
◆ Colour	3	
◆ Black & White	3	
▶ CMYK Exposure Adjustment	0	7-78
▶ <b>Bypass Tray Settings</b>		7-78
◆ Enable Detected Paper Size in Bypass Tray	Disabled	7-78
◆ Enable Selected Paper Type in Bypass Tray	Enabled	7-78
◆ Exclude Bypass-Tray from Auto Paper Select	Disabled	7-78
▶ Job Spool Queuing*	Enabled	7-78
▶ Disabling of USB Memory Direct Print*	Disabled	7-78
▶ Disabling of Network Folder Direct Print	Disabled	7-78
● <b>Interface Settings</b>		7-79
▶ Hexadecimal Dump Mode	Disabled	7-79
▶ I/O Timeout	60 sec.	7-79
▶ Enable USB Port	Enabled	7-79
▶ USB Port Emulation Switching	Auto	7-79
▶ Enable Network Port	Enabled	7-79
▶ Network Port Emulation Switching	Auto	7-79
▶ Port Switching Method	Switch at End of Job	7-79
● <b>Auto Colour Calibration</b>	–	7-80

\* On the MX-2314N, the productivity kit is required.

## Image Send Settings

Item	Factory default setting	Page
■ <b>Image Send Settings</b>		7-81
● <b>Operation Settings</b>		7-81
▶ <b>Other Settings</b>		7-81
◆ <b>Default Display Settings</b>	Scan (fax when fax is installed)	7-81
• Hold settings for a while after scanning has been completed	Disabled	
◆ <b>Address Book Default Selection</b>	Tab Switch: ABC, Address Type: All	7-81

Item	Factory default setting	Page
◆ Image Orientation	Portrait	7-81
◆ Initial Resolution Setting		7-81
• Scan	Apply the Resolution Set when Stored: Disabled 200 X 200 dpi	
• Internet Fax*1	Apply the Resolution Set when Stored: Disabled 200 X 100 dpi	
• Fax*2	Apply the Resolution Set when Stored: Disabled Standard	
◆ Default Exposure Settings	Auto	7-81
• Original Image Type	Text	
• Moiré Reduction	Disabled	
◆ Must Input Next Address Key at Broadcast Setting	Disabled	7-82
◆ Scan Complete Sound Setting	Middle	7-82
◆ The Number of File Name/Subject/Body Keys Displayed Setting	12	7-82
◆ The Number of Direct Address Keys Displayed Setting	10	7-82
◆ Disable Switching of Display Order	Disabled	7-82
◆ Hold Setting for Received Data Print	Disabled	7-82
◆ Default Verification Stamp	Disabled	7-82
◆ Erase Width Adjustment		7-82
• Edge Clearance Width	10 mm (1/2")	
• Centre Clearance Width	10 mm (1/2")	
▶ Settings to Disable Registration		7-82
◆ Disable Registering Destination from Operation Panel	All disabled	7-82
◆ Disable Registering Destination on Web Page*3	All disabled	7-82
◆ Disable Registration of Program	All disabled	7-83
◆ Disable Registration of Memory Box	All disabled	7-83
◆ Disable Destination Registration Using Global Address Search*3	All disabled	7-83
◆ Disable Registration Using Network Scanner Tool*3	Disabled	7-83
▶ Settings to Disable Transmission		7-83
◆ Disable [Resend] on Image Send Mode	Disabled	7-83
◆ Disable Selection From Address Book	All disabled	7-83
◆ Disable Direct Entry	All disabled	7-83
◆ Disable PC-I-Fax Transmission*1	Disabled	7-83
◆ Disable PC-Fax Transmission*2	Disabled	7-83

Item	Factory default setting	Page
▶ Own Name and Destination Set		
◆ Sender Data Registration		
• Sender Name	–	7-84
• Sender Fax Number	–	
• I-Fax Own Address	–	
◆ Registration of Own Name Select	–	7-84
● Scan Settings		7-85
▶ Other Settings		7-85
◆ Default Sender Set	–	7-85
◆ Default Colour Mode Settings		
• Black & White	Mono 2	7-85
• Colour Mode	Auto, Greyscale	
• Disable Change of B/W Setting in Auto Mode	Disabled	
◆ Initial File Format Setting		
• File Type	PDF	7-85
• Black & White	MMR (G4)	
• Colour/Greyscale	Medium	
• Specified Pages per File	Disabled	
• Number of Pages	Disabled	
◆ Compression Mode at Broadcasting		
• Black & White	MH (G3)	7-85
• Colour/Greyscale	Medium	
◆ Maximum Size of E-mail Attachments (E-mail)	Unlimited	7-86
◆ Maximum Size of Data Attachments (FTP/Desktop/Network Folder)	Unlimited	7-86
◆ Bcc Setting		
• Enable Bcc	Disabled	7-86
• Display Bcc Address on the Job Status Screen	Disabled	
◆ Disable Scan Function		
• USB Memory Scan	Disabled	7-86
• PC Scan	Disabled	
◆ Pre-Setting Mail Signature	Disabled	7-86
▶ Default Address Setting	Disabled	7-86
● I-Fax Settings*1		7-87
▶ I-Fax Default Settings		7-87
◆ Auto Wake Up Print	Enabled	7-87
◆ Compression Setting	MH (G3)	7-87

Item	Factory default setting	Page
◆ Speaker Volume Setting	–	
• Receive Signal	Middle	7-87
• Communication Error Signal	Middle	
◆ Original Print on Transaction Report	Print Out Error Report Only	7-87
◆ Transaction Report Print Select Setting		
• Single Sending	Print Out Error Report Only	7-87
• Broadcasting	Print Out All Report	
• Receiving	No Printed Report	
◆ Activity Report Print Select Setting		
• Auto Print at Memory Full	Disabled	7-88
• Print Daily at Designated Time	Disabled	
◆ Body Text Print Select Setting	Disabled	7-88
◆ Pre-Setting Mail Signature	Disabled	7-88
▶ I-Fax Send Settings		7-88
◆ I-Fax Reception Report On/Off Setting	Disabled	7-88
◆ I-Fax Reception Report Request Timeout Setting	1 hour	7-88
◆ Number of Resend Times at Reception Error	2	7-88
◆ Maximum Size of E-mail Attachments	Unlimited	7-88
◆ Rotation Sending Setting	All Enabled	7-89
◆ Printing Page Number at Receiver	Enabled	7-89
◆ Recall in Case of Line Busy	Times: 2, Interval 3 min.	7-89
◆ Recall in Case of Communication Error	Times: 2, Interval 3 min.	7-89
▶ I-Fax Receive Settings		7-89
◆ Auto Receive Reduce Setting	Enabled	7-89
◆ Duplex Reception Setting	Disabled	7-89
◆ Set Address for Data Forwarding	–	
• Direct SMTP	Disabled	7-89
• Add Hostname or IP Address Too	Disabled	
• Hostname or IP Address	–	
◆ Letter Size RX Reduce Print*4	Disabled	7-90
◆ Receiving Date & Time Print	Disabled	7-90
◆ A3 RX Reduce*4	Disabled	7-90
◆ POP3 Communication Timeout Setting	60 sec.	7-90
◆ Reception Check Interval Setting	5 min.	7-90
◆ I-Fax Output Setting	Varies depending on the machine configuration	7-90
▶ Allow/Reject Mail or Domain Name Setting	All Invalid	7-90

\*1 When the Internet fax expansion kit is installed. (On the MX-2314N, the productivity kit is required.)

\*2 When the facsimile expansion kit is installed.

\*3 When network connection is enabled.

\*4 This function is not available in some countries and regions.

## Document Filing Settings\*1

Item	Factory default setting	Page
■ Document Filing Settings		7-91
● Other Settings		7-91
▶ Default Mode Settings	Sharing Mode	7-91
▶ Sort Method Setting	Date	7-91
▶ Administrator Authority Setting		7-91
◆ Delete File	Disabled	
◆ Delete Folder	Disabled	
◆ Change Password	Disabled	
▶ Delete All Quick Files		7-91
◆ Delete	–	
◆ Delete quick files at power up (protected files excluded)	Enabled	
▶ Default Colour Mode Settings		7-91
◆ Colour	Auto	
◆ Black & White	Mono 2	
▶ Default Exposure Settings	Auto	7-91
◆ Default Original Image Type	Text	
◆ Moiré Reduction	Disabled	
▶ Initial Resolution Settings	600 x 600 dpi	7-91
▶ Colour Data Compression Ratio Setting	Medium	7-92
▶ Scan Complete Sound Setting	Middle	7-92
▶ Default Output Tray*2	Varies depending on the machine configuration	7-92
▶ Disable Stamp for Reprinting	Disabled	7-92
▶ Batch Print Settings		7-92
◆ Selection of [All Users] is not allowed.	Enabled	
◆ Selection of [User Unknown] is not allowed.	Enabled	
▶ Erase Width Adjustment		7-92
◆ Edge Clearance Width	10 mm (1/2")	
◆ Centre Clearance Width	10 mm (1/2")	
▶ Card Shot Settings		7-92
◆ Original Size	X: 86 mm (3-3/8"), Y: 54 mm (2-1/8")	
◆ Fit to Store Size	Disabled	

Item	Factory default setting	Page
● <a href="#">Document Output Options</a>		
▶ Printer		
◆ Copier	Enabled	
◆ Printer	Enabled	
◆ Scan Send	Disabled	
◆ Internet Fax Send (Incl. PC-I-Fax)* <sup>3</sup>	Disabled	
◆ Fax Send (Incl. PC-Fax)* <sup>4</sup>	Disabled	
◆ Scan to HDD	Enabled	
▶ Scan Send		
◆ Copier	Disabled	
◆ Scan Send	Enabled	
◆ Internet Fax Send (Incl. PC-I-Fax)* <sup>3</sup>	Disabled	
◆ Fax Send (Incl. PC-Fax)* <sup>4</sup>	Disabled	
◆ Scan to HDD	Enabled	
▶ Internet Fax Send* <sup>3</sup>		
◆ Copier	Disabled	
◆ Scan Send	Disabled	
◆ Internet Fax Send (Incl. PC-I-Fax)	Enabled	
◆ Fax Send (Incl. PC-Fax)	Disabled	
◆ Scan to HDD	Disabled	
▶ Fax Send* <sup>4</sup>		
◆ Copier	Disabled	
◆ Scan Send	Disabled	
◆ Internet Fax Send (Incl. PC-I-Fax)* <sup>3</sup>	Disabled	
◆ Fax Send (Incl. PC-Fax)* <sup>4</sup>	Enabled	
◆ Scan to HDD	Disabled	
● <a href="#">Automatic Deletion of File Settings</a>	All invalid	<a href="#">7-93</a>

\*1 On the MX-2314N, the productivity kit is required.

\*2 When the exit tray unit is installed.

\*3 When the Internet fax expansion kit is installed.

\*4 When the facsimile expansion kit is installed.

## List Print (Administrator)

Item	Factory default setting	Page
■ <b>List Print (Administrator)</b>		7-94
● Administrator Settings List	–	7-94
● Image Sending Activity Report	–	7-94
● Data Receive/Forward List	–	7-94
● Web Settings List* <sup>1</sup>	–	7-94
● Metadata Set List* <sup>2</sup>	–	7-94

\*1 When network connection is enabled.

\*2 When the application integration module is installed. (On the MX-2314N, the productivity kit is required.)

## Security Settings

Item	Factory default setting	Page
■ <b>Security Settings</b>		7-95
● <b>SSL Settings</b>		7-95
▶ Server Port		
◆ HTTPS	Enabled	
◆ IPP-SSL	Disabled	
◆ Redirect HTTP to HTTPS in Device Web Page Access	Disabled	
▶ Client Port		
◆ HTTPS	Enabled	
◆ FTPS	Enabled	
◆ SMTP-SSL	Enabled	
◆ POP3-SSL	Enabled	
◆ LDAP-SSL	Enabled	
◆ Level of Encryption	Low	
● IPsec Settings	Disabled	
● IEEE802.1X Setting	Disabled	7-95
● Data Clearance Settings*	–	7-96
● Release Lock on File/Folder Operation	–	7-96
● Initialize Private Data/Data in Machine	–	7-96

\* On the MX-2314N, the productivity kit is required.

## Enable/Disable Settings

Item	Factory default setting	Page
■ <b>Enable/Disable Settings</b>		7-97
● <b>Printer Condition Settings</b>	Disabled	7-97
▶ User Control*1		7-97
▶ Disabling of Printing by Invalid User	Disabled	7-97
● <b>Operation Settings</b>		7-97
▶ Cancel Auto Clear Timer	Disabled	7-97
▶ Disabling of Job Priority Operation	Disabled	7-97
▶ Disabling of Bypass Printing	Disabled	7-97
▶ Disable Auto Key Repeat	Disabled	7-97
▶ Disabling of Clock Adjustment	Disabled	7-97
▶ Disabling of Covers/Inserts Mode	Disabled	7-97
● <b>Device Control</b>		7-97
▶ Disabling of Document Feeder	Disabled	7-97
▶ Disabling of Duplex	Disabled	7-97
▶ Disabling of Optional Paper Drawer*2	Disabled	7-97
▶ Disabling of Tray Setting	Disabled	7-97
▶ Disabling of Finisher*3	Disabled	7-97
▶ Disabling of Offset	Disabled	7-97
▶ Disabling of Stapler*3	Disabled	7-97
▶ Disabling of Punch*4	Disabled	7-97
▶ Disabling of Colour Mode*5	Disabled	7-98
▶ Disabling of Master Machine Mode	Disabled	7-98
▶ Disabling of Slave Machine Mode	Disabled	7-98
● <b>Copy Function Settings</b>		7-98
▶ Disabling Deletion of Job Programs	Disabled	7-98
▶ Disabling of Bypass-Tray in Duplex Copy	Disabled	7-98
▶ Disabling of Auto Paper Selection	Disabled	7-98
● <b>Printer Settings</b>		7-98
▶ Prohibit Notice Page Printing	Enabled	7-98
▶ Prohibit Test Page Printing	Disabled	7-98
▶ Exclude Bypass-Tray from Auto Paper Select	Disabled	7-98
▶ Disabling of USB Memory Direct Print*1	Disabled	7-98
▶ Disabling of Network Folder Direct Print	Disabled	7-98



Item	Factory default setting	Page
● Image Send Settings		7-98
▶ Other Disabling		7-98
◆ Disable Switching of Display Order	Disabled	7-98
◆ Disable Scan Function		7-98
• PC Scan	Disabled	
• USB Memory Scan	Disabled	
▶ Settings to Disable Registration		7-98
◆ Disable Registering Destination from Operation Panel	All disabled	7-98
◆ Disable Registering Destination on Web Page*6	All disabled	7-99
◆ Disable Registration of Program	All disabled	7-99
◆ Disable Registration of Memory Box	All disabled	7-99
◆ Disable Destination Registration Using Global Address Search*6	All disabled	7-99
◆ Disable Registration Using Network Scanner Tools*6	Disabled	7-99
▶ Settings to Disable Transmission		7-99
◆ Disable [Resend] on Image Send Mode	Disabled	7-99
◆ Disable Selection from Address Book	All disabled	7-99
◆ Disable Direct Entry	All disabled	7-99
◆ Disable PC-I-Fax Transmission*1, 7	Disabled	7-99
◆ Disable PC-Fax Transmission*8	Disabled	7-99
● Document Filing Settings*1		7-99
▶ Disable Stamp for Reprinting	Disabled	7-99
▶ Batch Print Settings		7-99
◆ Selection of [All Users] is not allowed.	Enabled	
◆ Selection of [User Unknown] is not allowed.	Enabled	

\*1 On the MX-2314N, the productivity kit is required.

\*2 When a paper drawer is installed.

\*3 When a finisher is installed.

\*4 When a punch module is installed.

\*5 When a colour-related problem has occurred.

\*6 When network connection is enabled.

\*7 When the Internet fax expansion kit is installed.

\*8 When the facsimile expansion kit is installed.

## Change Administrator Password

Item	Factory default setting	Page
■ Change Administrator Password	See "TO THE ADMINISTRATOR OF THE MACHINE" in the Start Guide.	7-100

## Product Key

Item	Factory default setting	Page
■ <b>Product Key*</b>		7-100
● Serial Number	–	7-100
● Font Kit for Barcode	–	7-100
● PS3 Expansion Kit	–	7-100
● Internet Fax Expansion Kit	–	7-100
● E-mail Alert and Status	–	7-100
● Application Integration Module	–	7-100
● Application Communication Module	–	7-100
● External Account Module	–	7-100
● XPS Expansion Kit	–	7-100

\* It may not be possible to use some settings, depending on the peripheral devices installed.

## Data Backup

Item	Factory default setting	Page
■ <b>Data Backup</b>		7-101
● Storage Backup	–	7-101
● Device Cloning	–	7-101

## Storing/Calling of System Settings

Item	Factory default setting	Page
■ <b>Storing/Calling of System Settings</b>		7-102
● Restore Factory Defaults	–	7-102
● Store Current Configuration	–	7-102
● Restore Configuration	–	7-102

## Sharp OSA Settings

Item	Factory default setting	Page
■ <b>Sharp OSA Settings*</b>		7-103
● External Account Setting		7-103
▶ External Account Control	Disabled	
▶ Enable Authentication by External Server	Disabled	
● USB Driver Settings		7-103
▶ External Keyboard	Internal driver	
▶ USB Memory	Internal driver	
▶ Level of Encryption	None	
● Job Priority Preference	Printing	7-103

\* When the external account module or application communication module are available. (On the MX-2314N, the productivity kit is required.)

# User Control



User Control is used to configure settings for user authentication. Touch the [User Control] key to configure the settings.

## User Authentication Setting

These settings enable or disable user authentication and specify the authentication method.

When user authentication is enabled, each user of the machine is registered. When a user logs in, settings for that user are applied. This function allows greater control of security and cost management than on previous machines.



In addition, even if the user information is not stored in the machine, it is possible to log in by directly entering user information stored on an LDAP server. In this case, the login user will be the factory-stored "User". For more information, see "[Factory-stored users](#)" (page 7-51).

-  • For the procedure for storing users, see "[User List](#)" (page 7-51).
-  • For more information on login procedures when user authentication is enabled, see "[USER AUTHENTICATION](#)" (page 1-17) in "1. BEFORE USING THE MACHINE".

## User Authentication

When [User Authentication] is enabled, the login screen appears before an operation is begun in any mode except the job status screen\*. You must log in as one of the stored users. (After logging in, you can move freely through the modes.)

\* The login screen appears when a document filing file is used or when a broadcast transmission is reattempted from the job status screen.

-  • The login screen will vary depending on the authentication method that is selected. For more information, see "[USER AUTHENTICATION](#)" (page 1-17) in "1. BEFORE USING THE MACHINE".
-  • When "Authenticate a User by User Number Only" is selected for the authentication method, network authentication cannot be used.

## Authentication Method Setting

This selects the authentication method. When using user authentication, be sure to configure this setting first. The items configured for users stored after the user authentication method is set vary depending on the selected authentication method.

### Authenticate a User by Login Name and Password

Standard authentication method using a login name and password.

### Authenticate a User by Login Name, Password and E-mail Address

In addition to a login name and password, this authentication method also requires the entry of an e-mail address.

### Authenticate a User by User Number Only

This can be used as a simple authentication method when network authentication is not used.

## Device Account Mode Setting



A specific user can be stored as an auto login user.

When this setting is enabled, login can be performed automatically.

This function eliminates the bother of logging in but still allows the settings of the selected user (network settings, favourite operations, etc.) to be applied.

You can also allow users other than the auto login user to temporarily log in and work using their own authority and settings. To allow other users to log in temporarily when [Device Account Mode] is enabled, select [Allow Login by Different User].

As an example, this enables uses such as "authentication for colour copying only".

-  • If auto login fails for some reason when auto login is enabled, or the login user does not have administrator rights, all system settings or the system settings (administrator) will lock. In this event, the administrator should touch the [Admin Password] key in the system settings screen and log in again.
-  • To log in as a user other than the auto login user when [Allow Login by Different User] is enabled, press the [LOGOUT] key (⊗) to cancel the auto user login state. The user authentication screen will appear to let you log in. After using the machine, press the [LOGOUT] key (⊗) to log out.

## Other Settings

### Actions when the Limit of Pages for Output Jobs

This setting determines whether or not a job will be completed if the page limit is reached while the job is in progress.

The following selections are available.

- Job is Stopped when the Limit of Pages is Reached
- Job is Completed even when the Limit of Pages is Reached

### The Number of User Name Displayed Setting

The number of users that are displayed in the user selection screen can be selected (6, 12, or 18 users).



This setting also applies to the user selection screen of document filing and the sender selection screen.

### A Warning when Login Fails

This setting is used to display a warning and prohibit login for five minutes if login fails three times in a row.

This prevents an unauthorised person from attempting to guess a password. (The number of failed login attempts is retained even if the power is turned off.)



Locking of the operation panel for 5 minutes can be cancelled by clicking [User Control] - [Default Settings] - [Release the Lock on Machine Operation Panel] in the Web page menu.

### Disabling of Printing by Invalid User

Printing by users whose information is not stored in the machine, such as printing without entering valid user information in the printer driver or printing of a file on an FTP server from the Web pages, can be prohibited.



When a print job is executed by a user that is not stored in the machine, the factory-stored "Other User" is used as the login user. For more information, see "[Factory-stored users](#)" (page 7-51).

### Automatically print stored jobs after login

(On the MX-2314N, the productivity kit is required.)

When retention is enabled in the printer driver and print data has been spooled to the machine, you can have the spooled print data automatically print out when the user who enabled retention logs in.

### Default Network Authentication Server Setting

Use this to set the default network authentication server. When a user logs in from the Web page or sends a print job to the machine using user information that is not stored on the machine, the authentication server is not known. This setting is used to specify one of the LDAP servers stored on the machine as the authentication server.



When login is performed by network authentication using user information that is not stored in the machine, the login user will be the factory-stored "User". For more information, see "[Factory-stored users](#)" (page 7-51).

## Perform LDAP server access control.

Access control information for page count limits, authorities, and favourite operations can be stored on an LDAP server, and by using this LDAP server for network authentication, user authentication based on the stored access control information can be performed.

This can be used when user authentication is performed by network authentication using an LDAP server or a directory service (Active Directory, etc.).

Before using this function, configure settings for authentication by LDAP server, obtain control numbers for the "Pages Limit Group", "Authority Group", "Favourite Operation Group", and "My Folder" (including base settings for each group), and associate these with the control numbers registered in the machine.

To use this function, attributes associated with "Pages Limit Group", "Authority Group", "Favourite Operation Group", and "My Folder" must be added to the directory information of the LDAP server used for user authentication.

The attribute information is indicated below. Settings previously stored in the machine cannot be changed.

Attribute	Name of attribute in factory default state	Setting
Pages Limit Group	pagelimit	Registration number of pages limit group stored in the machine, or group name previously stored in the machine. Unlimited: unlimited
Authority Group	authority	Registration number of authority group stored in the machine, or group name previously stored in the machine. Admin: admin User: user Guest: guest
Favourite Operation Group	favourite	Registration number of favourite operation group stored in the machine, or group name previously stored in the machine. Following the System Settings: system settings

Attribute	Name of attribute in factory default state	Setting
My Folder	myfolder	Folder name of user folder stored in the machine. Do not enter if the default folder is specified.

The names of attributes that the machine obtains from the LDAP server can be changed in "Pages Limit Group", "Authority Group", "Favourite Operation Group", and "My Folder" in "Network Settings" > "LDAP Settings" on the Web page.

The "Pages Limit Group", "Authority Group", and "Favourite Operation Group" information that is stored in each machine determines the authority and settings that the user is actually granted. To use this function to ensure that users are granted the same authority and settings on any machine, the same "Pages Limit Group", "Authority Group", and "Favourite Operation Group" information must be stored in each machine using the same registration numbers.

For "My Folder", the same folder name must be stored in "Custom Folder" in each machine.

The directory information of the LDAP server that is used cannot be changed from the machine. Consult the administrator of the LDAP server.

### Users auto-registered

When access control is enabled and login is performed by network authentication, the user information in the LDAP server is automatically stored in the machine.

The information stored is as follows:

Item	Description
User Name	Information is acquired from the LDAP server.*
Initial	1
Index	User 1
Password	–
Authentication Settings	–
Authentication Server	Network Authentication

Item	Description
E-mail Address	Information is acquired from the LDAP server.
My Folder	
Pages Limit Group	
Authority Group	
Favourite Operation Group	

\* If the user name cannot be acquired, the first 16 characters of the text string entered as the user name for network authentication is used.

If the login name is different but the user name received from the LDAP server is the same, or if the user name is already registered on the machine, "Can not login because the user name entered has been previously registered" will appear and login will not be possible. In this case, the user name stored on the LDAP server or the user name stored on the machine must be changed. Consult the administrator of the machine.

If automatic registration by LDAP authentication is attempted when 1000 users are already stored, the following message will appear and login will not be possible: "Maximum entries for User Name is 1000. Please delete old or unused user name." Consult the administrator of the machine.



- If access control information cannot be obtained from the LDAP server used for authentication, user authentication cannot take place.
- If a user that is registered in the machine is authenticated by network authentication, the user registration settings in the machine will be given priority for the page count limit group, authority group, favourite operations group, and my folder.
- If the access control obtained from the LDAP server is not registered in the machine, the factory default user authority will be applied.
- When this function is not enabled and a user is authenticated by network authentication as a non-registered user, the factory default user authority will be applied.

## Display Usage Status after Login

When user authentication is enabled, this setting specifies whether or not the page counts of a user appear when the user logs in.

## User Information Print

The following lists can be printed.

- User List
- List of Number of Pages Used
- Page Limit Group List\*
- Authority Group List
- Favourite Operation Group List\*
- All User Information Print

Touch the key of the desired list to begin printing.

\* Cannot be printed when no groups are stored.

## User List

This is used to store, edit, and delete users when user authentication is enabled. When the [User List] key is touched, the following screen appears.

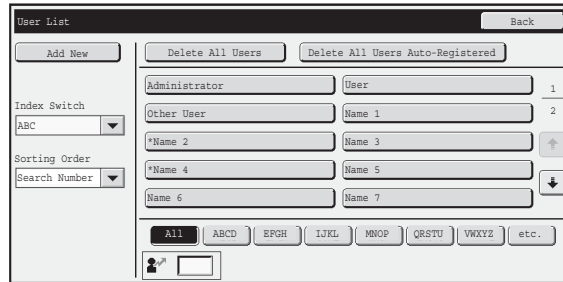

- **[Add New] key**

Use this to add a new user.

- **[Delete All Users] key**

Use this to delete all stored users. (Excluding factory stored users.) This operation can only be performed by an administrator.

- **Delete All Users Auto-Registered**

Delete all auto-registered users.

- [Users auto-registered](#) (page 7-49)

- **User List**

This shows the factory-stored users and the currently stored users. An asterisk [\*] appears in front of the user name of auto-registered users.

A user can be selected to open an edit/delete screen for the user.

## Storing a user

Touch the [Add New] key in the above screen to open a registration screen. Up to 1000 users can be stored. For more information, see "[Settings](#)" (page 7-52).

## Editing/deleting a user

A user can be selected from the list in the above screen to open an edit/delete screen for the user.

For more information, see "[Settings](#)" (page 7-52).

Delete a user with the [Delete] key.



- When auto login is enabled, "Delete All Users" cannot be used.
- The factory-stored users cannot be deleted.

## Factory-stored users

The following users are stored in the machine at the factory.

- **Administrator:** Factory-stored account for the administrator of the machine.
- **User:** This is used when network authentication is used and a login name not stored in the machine is directly entered. (This cannot be selected in the login user screen.)
- **Other User:** This is used when a print job is executed using invalid user information. (This cannot be selected in the login user screen.)

For settings related to each of the users, see the following table.

User Name	Administrator	User	Other User
Login Name	admin	users	Other
Password	(See the Start Guide.)* 1	users*1	–
My Folder	–		Main Folder
Authentication Settings	Login Locally		–

<b>Pages Limit Group</b>	Unlimited*1		
<b>Authority Group*2</b>	Admin	User*1	Guest*1
<b>Favourite Operation Group</b>	Following the System Settings*1		

\*1 Items that can be changed.

\*2 For detailed information of each of the settings, see "[List of settings and factory default settings of template groups](#)" (page 7-55).

## Settings

Item	Description
User Name	Store the name of the user (max. 32 characters). This user name is used as the key name in the login screen, the document filing user name, and the sender name. (The user name must be unique.)
Apply User Name to Log-in Name*1	Touch this key to enter the entered user name in the login name.
Initial	This determines where the user name will appear in the user list. Up to 10 characters can be entered.
Index	Select the desired custom index. The custom index names are the same as those in the address book.
User Number*2	Enter a user number (5 to 8 digits).
Login Name*1	Enter the login name used when authentication by login name/password is enabled (maximum of 255 characters). (The login name must be unique.)
Password*1, 3	Enter the password used when authentication by login name/password is enabled (1 to 32 characters). (The password can be omitted.)
E-mail Address	Enter the e-mail address used in the sender list and for LDAP authentication (maximum of 64 characters).
My Folder	A folder ("My Folder") can be specified as the folder used by the user for document filing. A previously created folder can be selected or you can create and select a new folder.
Authentication Settings*1	Select [Login Locally] or [Network Authentication] (when LDAP is enabled) for "Authenticate to:".
Authentication Server	When [Network Authentication] is selected, select the server to be used for user authentication from the list of LDAP servers stored in the Web pages.
Pages Limit Group	Specify page limits for the user by selecting one of the stored page limit groups. The factory default setting is [Unlimited]. For more information, see " <a href="#">Page Limit Group List</a> " (page 7-53).
Authority Group	Specify the authority of the user by selecting one of the stored authority groups. The factory default setting is [User]. For more information, see " <a href="#">Authority Group List</a> " (page 7-54).
Favourite Operation Group	The favourite operation group that will be applied at login appears. The factory default setting is [Following the System Settings]. The setting can be changed in the [User Control] menu in the Web pages.

\*1 Does not appear when "User Number" is selected for the authentication method.

\*2 Only appears when "User Number" is selected for the authentication method.

\*3 Not required when network authentication is used, as the password stored in the LDAP server is used.



## Page Limit Group List

This is used to store groups of Account Limit Settings. The page limits for each user are specified by selecting one of these stored groups when the user is stored.

When the [Page Limit Group List] key is touched, the following screen appears.

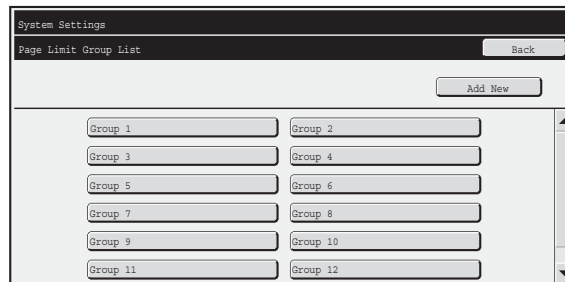

- **[Add New] key**

Use this to add a new group.

- **List display**

This shows the currently stored groups. A group name can be selected to open an edit/delete screen for that group.

## Storing a page limit group

Touch the [Add New] key in the above screen to open a registration screen. Up to 20 groups can be stored.

For more information, see "[Settings](#)".

## Editing a page limit group

A group can be selected from the list in the above screen to open an edit/delete screen for the group.

For information on the settings, see "[Settings](#)".

To return a group to the factory default state, set "Select the Group Name to be the Registration Model" to "Unlimited" in the editing screen.

## Settings

Item	Description
Group Name	Store the name of the group (max. 32 characters).
Select the Group Name to be the Registration Model	Select one of the previously stored groups for use as a template for the new group. When selected, the group's settings are applied.
Function names	The names of the functions that can be configured are displayed. Set a limit for each function.
Page Limit	When [Prohibited] is selected for a mode, input and output from the mode are prohibited. When [Unlimited] is selected for a mode, there is no limit to the number of pages that can be input/output in that mode. When [Limited] is selected, enter a limit (1 to 99999999 pages).

# Authority Group List

Use this to store groups of user authority settings. The authority of each user is specified by selecting one of these stored groups when the user is stored.

When the [Authority Group List] key is touched, the following screen appears.

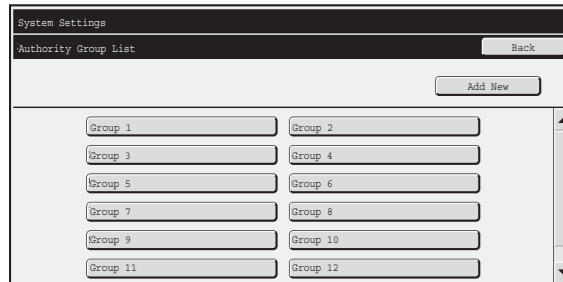

- **[Add New] key**

Use this to add a new group.

- **List display**

This shows the currently stored groups. A group name can be selected to open an edit/delete screen for that group.

## Storing an authority group

Touch the [Add New] key in the above screen to open a registration screen. Up to 20 groups can be stored.

For information on the settings, see "[List of settings and factory default settings of template groups](#)" (page 7-55).

## Editing an authority group

A group can be selected from the list in the above screen to open an edit/delete screen for the group. For information on the settings, see "[List of settings and factory default settings of template groups](#)" (page 7-55).

To return a group to the factory default state, select [Return to Administrator Authority], [Return to User Authority], or [Return to Guest Authority].

## List of settings and factory default settings of template groups

Item	Description		
Group Name	Store the name of the group (max. 32 characters).		
Select the Group Name to be the Registration Model	Select one of the previously stored groups for use as a template for the new group. When selected, the group's settings are applied. The factory default groups and their settings are shown below.		
	<b>Admin</b>	<b>User</b>	<b>Guest</b>
<b>Copy</b>			
Colour Mode Approval Setting	All allowed	All allowed	Only Black & White Allowed
Special Modes Usage	Allowed	Allowed	Prohibited
<b>Printer</b>			
Colour Mode Approval Setting	Allowed	Allowed	Only Black & White Allowed
FTP Pull Print	Allowed	Allowed	Prohibited
USB Memory Direct Print	Allowed	Allowed	Prohibited
Network Folder Pull Print	Allowed	Allowed	Prohibited
<b>Image Send</b>			
Approval Settings for Each Mode			
<ul style="list-style-type: none"> <li>• E-mail</li> <li>• FTP</li> <li>• Desktop</li> <li>• Network Folder</li> <li>• USB Memory</li> <li>• PC Scan</li> <li>• Internet Fax Send</li> <li>• PC-I-Fax Send</li> <li>• Fax Send</li> <li>• PC-Fax Send</li> </ul>	All allowed	All allowed	All allowed
Colour Scan	Allowed	Allowed	Prohibited
Special Modes Usage	Allowed	Allowed	Prohibited
Approval Setting for Addressing			
<ul style="list-style-type: none"> <li>• Approval Setting for Direct Entry</li> <li>• Approval Setting to Use a Local Address Book</li> <li>• Approval Settings to Use a Global Address Book</li> </ul>	All allowed	All allowed	All allowed
<b>Document Filing</b>			
Scan to HDD			
<ul style="list-style-type: none"> <li>• Colour Mode Approval Setting</li> </ul>	All allowed	All allowed	Only Black & White Allowed
<ul style="list-style-type: none"> <li>• Special Modes Usage</li> </ul>	Allowed	Allowed	Prohibited

Item	Description		
Prints (Document Filing)			
• Colour Mode Approval Setting	All allowed	All allowed	Only Black & White Allowed
• Special Modes Usage	Allowed	Allowed	Prohibited
• Document Filing Image Check	Allowed	Allowed	Prohibited
• Display only the Files of Logged-in Users	Prohibited	Prohibited	Prohibited
<b>Common Functions</b>			
Approval Settings for 2-Sided Print	[1-Sided/2-Sided Approved]	[1-Sided/2-Sided Approved]	[1-Sided/2-Sided Approved]
Output Approval Settings	All allowed	All allowed	All prohibited
<b>MFP Settings</b>			
System Settings Operational Authority			
System Settings* <sup>1</sup>	Allowed* <sup>2</sup>	Only user authority settings are allowed	All settings prohibited
Web Settings Operational Authority			
Display of Device /Network Status	Allowed	Allowed	Prohibited
Power Reset		Prohibited	
Machine Identification		Prohibited	
Network Settings		Prohibited	
Application Settings (Excluding Registration of Pre-set Text/Forward Table)		Prohibited	
Registration of Pre-set Text/Forward Table		Allowed	
E-mail Alert and Status		Prohibited	
Job Log Setting		Prohibited	
Port Control/ Filter Settings		Prohibited	
Storage Backup		Prohibited	
Custom Link Setting		Prohibited	
Operation Manual Download		Allowed	

\*1 For information on each setting, see the system settings (general/administrator) lists.

\*2 All allowed except "Change Administrator Password".

 Depending on the machine specifications and peripheral devices installed, it may not be possible to use some settings.

# Favourite Operation Group List

This is used to store favourite operation groups and My Menu.

Some settings may not be configured depending on the connecting state of peripheral devices.



This setting can only be configured in the Web pages. It cannot be configured in the touch panel of the machine.

## Favourite Operation Group Registration

Sets of preferred settings can be as groups. For example, a user who speaks a different language would normally have to change the display language each time he or she uses the machine; however, by storing the language in a favourite operation group, the language is automatically selected when the user logs in.

### Settings

Item	Description
Group Name	Store the name of the group (max. 32 characters).
Select the Group Name to be the Registration Model	Select one of the previously stored groups for use as a template for the new group. When selected, the group's settings are applied.
<b>Copy</b>	
Initial Status Settings	Select settings for Colour Mode, Paper Tray, Exposure Type, Copy Ratio, Duplex, and Output.
<b>Image Send</b>	
Initial Status Settings	Select settings for Resolution, Exposure, Colour Mode, File Format, and Original Image Type. Store the default fax sender name and number.
<b>Document Filing</b>	
Scan to HDD: Initial Status Settings	Select settings for Colour Mode, Resolution, Exposure, Original Image Type and Compression Ratio.
Prints (Document Filing)	Set the default output tray for document filing print.
<b>System Settings</b>	
Original Size Detector Setting	Select whether AB sizes or inch sizes are detected, or disable detection on the document glass.
Display Language Setting	Select the display language.
Key Operation Setting	Set the key input time and Auto Key Repeat setting.
Keys Touch Sound	Set the sound made when keys are touched.
Keyboard Select	Set the language that appears on the keyboard.
MFP Display Pattern Setting	Select the colour pattern used in the touch panel.
Automatically print stored jobs after login	When retention is enabled in the printer driver and print data has been spooled to the machine, you can have the spooled print data automatically print out when the user who enabled retention logs in.
My Menu Settings	Select the My Menu.
<b>Preview Setting</b>	
Default Preview Display	Image Send: Set the zoom ratio of the preview that can be displayed when an image is received and in the memory box. Document Filing: Set the zoom ratio of the preview that can be displayed when a stored file is opened.
Default List/Thumbnail Display	Select whether the default display format is list or thumbnails.
<b>Customize Key Setting</b>	
Customize Key Setting	Set customized keys for each mode.

## My Menu List

Home screen settings must be previously stored. Select a My Menu when storing a favourite operation group.

### Settings

Item	Description
My Menu Name	Enter a maximum of 32 characters for the My Menu name.
Select the My Menu to be the Registration Model	Select one of the previously stored My Menus as a template for the new My Menu. When selected, the My Menu's settings are applied.
Display Title	Show a title on the My Menu.
Title	Enter a maximum of 70 characters for the title name.
Display User Name	Show the currently logged-in user name on the My Menu.
Display Date	Show the date and time on the My Menu.
Background Image	Select the image that appears in the background of the My Menu.
Select Template	A template for the design of the My Menu can be selected from the list. A sample of the selected template can be viewed.
Key Layout of the Screen	The layout of the keys in the My Menu is displayed.
Key Number	Select the number of the key that you want to set, referring to "Key Layout of the Screen".
Key Name	The name of the key selected in "Key Number" can be changed (maximum of 48 characters).
Link Item	Specify the function that you want to use in the key selected in "Key Number".

# User Count

This displays the total number of pages printed by each user. When the [User Count] key is touched, the following screen appears.

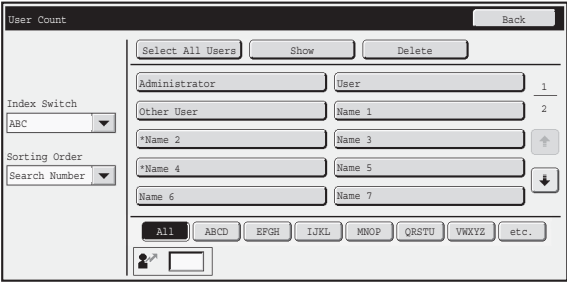

- **[Select All Users] key**  
This selects all users.
- **[Show] key**  
This shows the counts of the selected user.
- **[Delete] key**  
Use this to reset the counts of the selected user.

- **User List**  
This shows the factory-stored users and the currently stored users. To select a user, select the user name.

## Showing user count

Select a user in the above screen and touch the [Show] key. The counts of that user will appear.

Item	Settings
Next	This shows the next user (in the order of the registration numbers).
Previous	This shows the previous user (in the order of the registration numbers).
Show Counts	The counts and the number of pages remaining of the selected user are shown by function.
Page Limit	The page limit set for the user appears in parentheses below the count.

- Counts of devices that are not installed do not appear.
- A user count can be saved in the screen that appears when [User Control] - [User Count] - [Save User Count] is selected in the Web page menu.

## Resetting user counts

Select a user in the setting screen and touch the [Reset] key. A count reset screen for that user will appear. The reset screen will vary depending on whether a single user or multiple users were selected. The items displayed in each case are described in the table below.

### When a single user is selected

Item	Description
Next	This shows the next user (in the order of the registration numbers).
Previous	This shows the previous user (in the order of the registration numbers).
Show Counts	The counts and the number of pages remaining of the selected user are shown by function.
Clear Count	Reset the count of the selected item to "0".
Clear All Counts	Reset all items of the selected user to "0".

### When multiple users are selected

Item	Description
Show Counts	The counts and the number of pages remaining of the selected users are shown by function.
Clear Count	Reset the count of the selected item to "0".
Clear All Count	Reset all items of the selected users to "0".

## Card Setting

### (when the HID card reader is available.)

Configure this setting if user authentication will be performed using a Sharp OSA external authentication application and an HID card.

### Card Reader Device Registration

In this setting, the product ID and vender ID of the connected HID card reader are displayed. To store the HID card reader, touch the [Read] key.

\* For settings that enable an HID card to be used, consult your service technician.



# Energy Save

The Energy Save settings help reduce power costs. From an environmental perspective, these settings also help reduce pollution and conserve natural resources. Touch the [Energy Save] key to configure the settings.

## Eco Scan Setting

Non-print functions such as image sending and document filing function can be executed while the fusing unit is kept Off.

Whether to enable the Eco Scan setting can be specified for each mode or screen.

- Home Screen
- Copy
- Image Send
- Document Filing
- System Settings
- Sharp OSA

## Power Management Setting

Auto Power Shut-Off can be enabled or disabled, and Toner Save Mode can be set as well as Preheat Mode. This function reduces your power costs, and at the same time helps conserve natural resources and reduce pollution.

### Toner Save Mode

You can reduce the amount of toner used for printing.

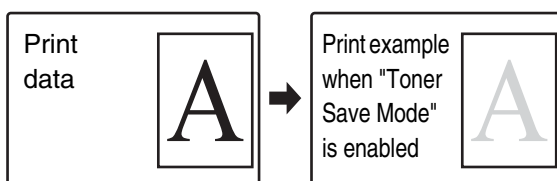

[Print] in Toner Save Mode is only effective when the machine's printer driver is not used. When the printer driver is used, the printer driver setting takes precedence.

This function may not operate in some applications and operating systems.

### Preheat Mode Setting

The time until Preheat Mode activates can be set to any number of minutes from 1 to 60.

Preheat Mode will activate when the set duration of time elapses after printing ends and no further operations are performed. This function reduces your power costs, and at the same time helps conserve natural resources and reduce pollution.

Select the time that best suits the needs of your workplace.

The following settings can be changed if necessary.

#### Turn off Panel Display during pre-heat mode

Setting this checkbox to  turns off the panel display in Preheat Mode.



Preheat mode cannot be disabled.

### Auto Power Shut-Off

This setting enables or disables Auto Power Shut-Off. Remove the checkmark if you prefer that Auto Power Shut-Off does not operate.

When the set duration of time elapses after printing ends, Auto Power Shut-Off activates and causes the machine to go on standby at a minimal level of power consumption.

This function reduces your power costs, and at the same time helps conserve natural resources and reduce pollution.

It is recommended that you understand the objective behind the energy save functions and instead of using the machine in the state where the Auto Power Shut-Off function is disabled, adjust the settings such that the time till Auto Power Shut-Off is enabled is a little longer or set a time zone for Auto Power Shut-Off. (Settings that depend on the usage conditions, such as the time till Auto Power Shut-Off is enabled can be configured in the following "[Auto Power Shut-Off Timer](#)".)

### Auto Power Shut-Off Timer

Settings that depend on the usage conditions, such as the time till Auto Power Shut-Off is enabled or the time

zone for Auto Power Shut-Off can be configured. In case of "Fix transition time", it can be set to "Earliest" or within a range of 1 to 60 minutes.

When "As soon as the remote job is finished, enter Auto power shut off mode" is enabled, Auto Power Shut-Off happens in a short while after the print job or fax reception is complete.

In case of settings that depend on the usage conditions, select "Change transition time by time of day".

As per the default settings, the time zone is set automatically depending on the application conditions of the machine. When it is to be selected manually, you can select from the following.

- All Day "Energy Save Priority2" : To be set when you want Auto Power Shut-Off to be enabled in minimum time in any time zone.
- 8:00-18:00 "Energy Save Priority1": To be set when this machine is to be used more frequently in this time zone than other time zones.
- 8:00-18:00 "Job Start Priority1": To be set when the frequency of use of this machine in this time zone is significantly more.
- Settings edited to match the usage conditions, combining the three patterns given above can also be selected.

#### Display Message When Extending Transition Time to Preheat/Auto Power Shut-Off Mode

If this checkbox is set to , a message appears asking you whether to delay transition to Preheat Mode or Auto Power Shut Off Mode, 15 seconds before the transition.

---

## Sleep Mode Power Level

The "Low Power" setting is a highly effective way to save power, however, it takes some time to wake up. The "Fast Wake Up" setting consumes more power than the "Low Power" setting, however, it shortens the wake up time.

## Power ON/OFF Schedule Setting

The machine operator panel can be turned On or Off at a preset time. Up to three patterns can be set. The "Setting 1", "Setting 2" and "Setting 3" are executed in this sequence if set at the same day of week or at the same clock time.



- The scheduling function does not support the power management settings in the Preheat Mode and Auto Power Shut-Off Mode.
- The preset power-off time is subject to the following restrictions:
  - If the machine is running due to the current job execution or other reasons, the machine is turned off only after the job has finished.
  - The machine cannot receive printer jobs.
  - The machine can receive output jobs, such as received fax data outputs.
  - If the Time Specified Output of Received Data setting is enabled, they are output next time the machine is turned on.
- If the power management setting is also enabled, the Power On/Off Scheduling settings precede.
- If the same time is specified, settings are applied in the order of "Setting 1", "Setting 2", and "Setting 3".
- The power is not turned off in the following cases:
  - "Automatic deletion when power is turned on" is in progress
  - While the optimization of the hard disk is in progress or while a restart is in progress after the setting mode has been changed.
  - The preset power on/off time is within one minute from when the setting is accepted.

# Operation Settings

Settings related to machine operation can be configured. Touch the [Operation Settings] key to configure the settings.

## Other Settings

### Keys Touch Sound

This setting is used to adjust (or turn off) the volume of the beep that sounds when you touch a key. You can also have three beeps sound at initial values when setting the ratio in copy mode or when adjusting the exposure in any mode.

Screen in which setting is effective	Initial value
Ratio setting screen in base screen of copy mode	Ratio 100%
Exposure adjustment screen in base screen of copy mode	Exposure level: 3 (medium)
Exposure adjustment screen in base screen of fax, Internet fax, and network scanner modes	
Exposure adjustment screen for Scan to HDD in document filing mode	

### Auto Clear Setting

The time until Auto Clear activates can be set to any number of minutes from 10 to 240.

If the machine is not used for the duration of time set here, the auto clear function will clear any settings that have been selected and return the screen to the base screen of copy mode or the job status screen.

#### Cancel Timer

This is used to disable the auto clear function.

### Message Time Setting

The duration of time that messages appear in the touch panel (the time until a message is automatically cleared) can be set to any number of seconds from 1 to 12.

### Display Language Setting

The language that appears in the touch panel can be changed.



When user authentication is enabled and a display language is specified in the favourite operation group, that setting is given priority.

### Default Display Settings

Set the screen that appears after auto clear and login. You can select the base screen of copy, fax / image send, or document filing mode, the home screen, or the Sharp OSA screen\*.

\* When the application communication module is installed.

### Disabling of Job Priority Operation

This disables the job priority function and hides the [Priority] key in the job status screen.

### Disabling of Bypass Printing

This is used to disable bypass printing (printing other jobs ahead of a job that has been stopped\* because the paper required for the job is not in any of the trays).

\* This does not include cases where the paper ran out during the job.

### Key Operation Setting

This setting determines how long a key in the touch panel must be touched until the key input is registered. The time can be set from 0 to 2 seconds in increments of 0.5 seconds.

By lengthening the time setting, key input can be prevented when a key is touched accidentally. Keep in mind, however, that when a longer setting is selected more care is required when touching keys to ensure that key input is registered.

#### Disable Auto Key Repeat

This is used to disable key repeat.

Key repeat causes a setting to change continuously while a key is touched, not only each time the key is touched.

---

## Disabling of Clock Adjustment

This setting is used to prohibit changing of the date and time.

---

## Disabling of Covers/Inserts Mode

This setting is used to prohibit the use of the covers and inserts function.

---

## Set Keyboard Priority

When an external keyboard is connected, you can select whether the soft keyboard or the external keyboard is used.

---

## Initial Original Count Setting

This specifies whether or not "Original Count" in the special functions is enabled for each function.

### Copy

- Copy

### Image Send

- Scan
- Internet Fax
- Fax Job
- Data Entry

### Document Filing

- Scan to HDD

## MFP Display Pattern Setting

One of six colour patterns can be selected for the colour pattern in the touch panel.  
A sample of the selected pattern can be viewed.

## Customize Key Setting

Short-cuts to functions that are frequently used can be displayed in the base screen of each mode.  
For information on customize keys, see the chapters for each function.  
The settings are shown below.

Item	Description
Customized Keys 1 - 3	Enter a name for the customized key (maximum of 14 characters).
Item	Select the function that you want to assign to the key. The functions that can be selected vary by mode.
Return to the Defaults	This returns all customized keys to their factory default state.



This setting can only be configured in the Web pages. It cannot be configured in the touch panel of the machine.

## Home Screen Settings

Use this to configure the home screen that appears when the [HOME] key (🏠) is touched.  
The settings are shown below.

Item	Description	
Mode Keys	Key Name	When [Custom] is selected, any key name (maximum of 16 characters) can be entered.
	Image	When [Use Custom Image] is selected, the Mode Key image can be changed using a gif file of up to 10 KB in size.
Application Keys	A shortcut to the Sharp OSA application and keys that appear in "My Menu" can be stored (a total of eight keys can be stored).	
Background Image	When [Use Custom Image] is selected, the background of the home screen can be changed using a 392 x 800 dot gif, png, jpg, or bmp file of up to 310 KB in size.	



This setting can only be configured in the Web pages. It cannot be configured in the touch panel of the machine.

## My Menu Settings

Use this to configure the My Menu screen that appears when the [My Menu] key is pressed. The settings are shown below.

Item	Description
Display Title	Show a title on the My Menu.
Title	Enter a maximum of 70 characters for the title name.
Display User Name*	Show the currently logged-in user name on the My Menu.
Display Date	Show the date and time on the My Menu.
Background Image	Select the image that appears in the background of the My Menu.
Select Template	A template for the design of the My Menu can be selected from the list. A sample of the selected template can be viewed.
Key Layout of the Screen	The layout of the keys in the My Menu is displayed.
Key Number	Select the number of the key that you want to configure, referring to "Key Layout of the Screen".
Key Name	The name of the key selected in "Key Number" can be changed (maximum of 48 characters).
Link Item	Specify the function that you want to use in the key selected in "Key Number".

\* Does not appear when user authentication is not enabled.



This setting can only be configured in the Web pages. It cannot be configured in the touch panel of the machine.

## Preview Setting

(On the MX-2314N, the productivity kit is required.)  
Configure settings for the preview screen that can be used for fax / image send and document filing.

---

### Default Preview

Set the selection state of the [Preview] key in each of the screens below.

#### Copy

#### Image Send

- Scan Send
- Internet Fax Send
- Fax Send
- Data Entry
- USB Memory Scan
- Address Book

#### Document Filing

- Scan to HDD

---

### Default Preview Display

Set the display zoom ratio of the preview screen for copy, fax / image send, and document filing.

---

### Received Data Image Check Setting

Select whether or not a preview of received faxes and Internet faxes is shown.

---

### Default List/Thumbnail Display

Select whether the default display format of the document filing file selection screen and the received fax list screen is list or thumbnails.

## Soft Keyboard Template Setting

Store text that you frequently use when entering an address or domain. Up to 16 characters can be entered.

## Cookie Setting

Select whether or not information about cookies is stored in the MFP when using Sharp OSA.

## Delete Cookie

Delete the information about cookies stored in the MFP.

## Remote Operation Settings

Configure settings required for remote operation of the machine from a computer connected to the same network.

---

### Remote Software Operation

#### Operational Authority

This is used when remote software is used to operate the machine remotely.

#### View Password Entry Screen

When remote software is used to operate the machine remotely, you can have a password entry screen appear on the machine, on the computer, or both.

---

### Operation from Specified PC

#### Operational Authority

This is used to allow remote operation of the machine using a specified computer.

#### Hostname or IP Address of PC

Enter the host name or IP address of the computer that will connect to the machine.

A maximum of 127 characters can be entered.

#### View Password Entry Screen

When a specified computer is used to operate the machine remotely, you can have a password entry screen appear on the machine, on the computer, or both.

---

### Operation by User who Has Password

#### Operational Authority

This is used to allow a user who has a password to operate the machine. For information on the password, consult your service technician.

#### View Password Entry Screen

When a user who has a password operates the machine remotely, you can have a password entry screen appear on the machine, on the computer, or both.

# Device Control

These settings control devices installed on the machine. Touch the [Device Control] key to configure the settings.

## Other Settings

### Original Feeding Mode

The following original feeding modes can be set to operate by default in copy, Scan to HDD, and image send modes. When a mode is frequently used, this saves you from having to select the mode in the special modes each time you need to use it.

- Mixed Size Original (Same Width (Copy mode only)/Different Width)
- Slow Scan Mode
- Blank Page Skip (image send\*)

\* Excluding fax mode and Internet fax mode.

### Auto Paper Selection Setting

The paper types\* that the Auto Paper Selection function will select can be specified. Select one of the following settings:

- Plain Paper
- Plain and Recycle Paper
- Recycle Paper

The Auto Paper Selection function will not select any paper types other than the paper types specified with this setting.

\* The paper type set for each paper tray using "Paper Tray Settings" (page 7-13) in the system settings (general).

### Tandem Connection Setting

(On the MX-2314N, the productivity kit is required.)

When two machines are used as network printers using TCP/IP protocol, use this setting to configure the port number and IP address of the machine used as the tandem slave machine.

#### Disabling of Master Machine Mode

To prohibit tandem transmission, enable this setting. (There is normally no need to enable this setting.)

#### Disabling of Slave Machine Mode

To prohibit tandem reception, enable this setting. (There is normally no need to enable this setting.)



- The factory default setting for the port number is [50001]. Unless you experience difficulty with this setting, do not change the port number.
- To use the tandem function when user authentication is enabled, the same login name and password must be used on both the master machine and slave machine. If the same login name and password are not used, the page count may not be added to the appropriate user count or only the master machine may print.

### Detect Standard in Auto Colour Mode

When the colour mode is set to auto in copy mode, the discrimination point for detecting whether originals are colour or black and white can be set to one of 5 levels. To make it easier to detect a black and white original, adjust the setting toward [Black & White]. To make it easier to detect a colour original, adjust the setting toward [Colour].

### Registration Adjustment

If the colours are out of place on the printed surface when colour printing is performed, the print positions of the colours can be adjusted.

To perform this adjustment, touch the [Auto Adjustment] key. A message will appear. Touch the [Execute] key.

### Optimization of a Hard Disk

(On the MX-2314N, the productivity kit is required.)

This function optimizes the hard drive of the machine by defragmenting data. If a job is in progress, a message will appear and optimization will not begin until the job is finished. During optimization, the following operations are not possible:

- Web page access, reception of print data
- Use of keys on the operation panel
- Turning off the power with the main power switch of the machine.
- Auto Power Shut-Off

When optimization is completed, the machine will automatically restart.



When the document filing function is frequently used and output of files seems somewhat slow, optimizing the hard drive may improve performance.

### Fusing Cleaning Mode

Use this function to clean the machine's fusing unit when dots or other dirt appear on the printed side of the paper. When this function is executed, "V" printed paper is output and the fusing unit is cleaned.



If improvement is not noticed after the first time you use the function, try executing the function again.



---

## Clear All Job Log Data

(On the MX-2314N, the productivity kit is required.)

This is used to clear the entire job log. (There is normally no need to use this function.)

A log file is kept of jobs run on the machine. The job log can be used to check general use of the machine. The job log can be written to a computer in CSV format using a Web browser.

## Original Size Detector Setting

One of the 8 groups of standard original sizes shown below can be selected for detection by the original size detection function.

Selections	Detectable original sizes	
	Document glass	Document feeder tray (automatic document feeder)
AB-1	A3, A4, A4R, A5, B4, B5, B5R	A3, A4, A4R, A5, B4, B5, B5R, 11" x 17", 8-1/2" x 14", 8-1/2" x 11"
AB-2	A3, A4, A4R, A5, B5, B5R, 216 mm x 330 mm (8-1/2" x 13")	A3, A4, A4R, A5, B4, B5, B5R, 11" x 17", 8-1/2" x 11", 216 mm x 330 mm (8-1/2" x 13")
AB-3	A4, A4R, A5, B4, 8K, 16K, 16KR	A3, A4, A4R, A5, B4, 11" x 17", 8-1/2" x 11", 216 mm x 330 mm (8-1/2" x 13"), 8K, 16K, 16KR,
AB-4	A3, A4, A4R, A5, B5, B5R, 216 mm x 340 mm (8-1/2" x 13-2/5")	A3, A4, A4R, A5, B4, B5, B5R, 11" x 17", 8-1/2" x 11", 216 mm x 340 mm (8-1/2" x 13-2/5")
AB-5	A3, A4, A4R, A5, B5, B5R, 216 mm x 343 mm (8-1/2" x 13-1/2")	A3, A4, A4R, A5, B4, B5, B5R, 11" x 17", 8-1/2" x 11", 216 mm x 343 mm (8-1/2" x 13-1/2")
Inch-1	11" x 17", 8-1/2" x 14", 8-1/2" x 11", 8-1/2" x 11"R, 5-1/2" x 8-1/2"	11" x 17", 8-1/2" x 14", 8-1/2" x 11", 8-1/2" x 11"R, 5-1/2" x 8-1/2", A3, A4
Inch-2	11" x 17", 216 mm x 330 mm(8-1/2" x 13"), 8-1/2" x 11", 8-1/2" x 11"R, 5-1/2" x 8-1/2"	11" x 17", 216 mm x 330 mm(8-1/2" x 13"), 8-1/2" x 11", 8-1/2" x 11"R, 5-1/2" x 8-1/2", A3, A4
Inch-3	11" x 17", 8-1/2" x 13-2/5" (216 mm x 340 mm), 8-1/2" x 11", 8-1/2" x 11"R, 5-1/2" x 8-1/2"	11" x 17", 8-1/2" x 13-2/5" (216 mm x 340 mm), 8-1/2" x 11", 8-1/2" x 11"R, 5-1/2" x 8-1/2", A3, A4

### Cancel Detection at Document Glass

Original size detection on the document glass can be disabled. When this is done, all originals placed on the document glass are treated as special size originals.

## Disabling of Devices

Use these settings when a peripheral device on the machine has failed or when you wish to temporarily disable a device.

### Disabling of Document Feeder

Use this setting to prohibit the use of the automatic document feeder, such as when the feeder malfunctions. (When the setting is enabled, scanning is still possible using the document glass.)

### Disabling of Duplex

This is used to disable two-sided printing, such as when the duplex module malfunctions.

### Disabling of Optional Paper Drawer

(When an optional paper drawer is installed.)

This setting is used to disable the optional paper drawer, such as when it malfunctions.

### Disabling of Tray Settings

This setting is used to prohibit tray settings (except for the bypass tray).

### Disabling of Finisher

(When a finisher is installed.)

This setting is used to disable the finisher, such as when the unit malfunctions.

### Disabling of Offset

This setting is used to disable the offset function.

### Disabling of Stapler

(When a finisher is installed.)

This setting is used to prohibit stapling, such as when the stapler unit of the finisher malfunctions.

### Disabling of Punch

(When a punch module is installed.)

This setting is used to prohibit punching, such as when the punch module of the finisher malfunctions.

### Disabling of Colour Mode

(When a colour-related problem has occurred.)

When a colour-related problem has occurred and printing is not possible, the use of colour mode can be temporarily prohibited. Black & white printing will still be allowed.



This function is only for use as an emergency measure. Once this setting is enabled, only a service technician can cancel the setting. Promptly contact your dealer or nearest authorised service representative to have a service technician cancel the setting and resolve the colour-related problem.

## Fusing Control Settings

These are used to control the toner fusing temperature according to the weight of the paper.

These settings apply to plain paper, punched paper, pre-printed paper, letterhead paper, coloured paper, and user type paper.

You can select "60 g/m<sup>2</sup> to 89 g/m<sup>2</sup>" or "90 g/m<sup>2</sup> to 105 g/m<sup>2</sup>" ("16 to 23 lbs." or "23+ to 28 lbs.").



- Be sure to use only paper that is in the same weight range as the weight range set here. Do not mix plain or other paper that is outside the range with the paper in the tray.
- When settings are changed, the changes will take effect after the machine is restarted. To restart the machine see "[TURNING THE POWER ON AND OFF](#)" (page 1-15) in "1. BEFORE USING THE MACHINE".

# Copy Function Settings

The following settings are related to copying. Touch the [Copy Function Settings] key to configure the settings. Default settings selected with these settings apply to all functions of the machine (not just the copy function).

## Initial Status Settings

The copier settings are reset when the [POWER] key (⏻) is turned on, when the [CLEAR ALL] key (Ⓢ) is pressed, or when the auto clear interval has elapsed. These settings are used to change the default settings for copy mode.

The following settings can be changed:

Item	Description
Colour Mode	Configure default colour mode settings.
Paper Tray	Specify the paper tray that is selected by default.
Exposure Type	Configure exposure mode settings.
Copy Ratio	Specify the copy ratio that is selected by default.
2-Sided Copy	Configure the 2-sided mode settings that are selected by default. If this setting is used to change the default setting for the duplex function to other than "1-Side to 1-Side" and the duplex function or automatic document feeder fails or is disabled, the setting will revert to "1-Side to 1-Side".
Output	Set the print output method and output tray that are selected by default.
Return to the Defaults	This returns all items to the factory default settings.

## Other Settings

### Copy Exposure Adjustment

This is used to adjust the exposure level when [Auto] is used for the copy exposure.

#### Colour

Use this to set the copy exposure level in colour mode for the document glass and for the automatic document feeder.

#### Black & White

Use this to set the copy exposure level in black & white mode for the document glass and for the automatic document feeder.

### Rotation Copy Setting

When the original and paper are placed in different orientations, this function automatically rotates the image 90 degrees to enable correct copying on the paper.



- Image rotation can only take place when automatic paper selection or automatic ratio selection is enabled.
- The Rotation Copy setting must be enabled when copying an A5 (5-1/2" x 8-1/2") size original on A5R (5-1/2" x 8-1/2"R) paper.

### Add or Change Extra Preset Ratios

Two enlargement preset ratios (101% to 400%) and two reduction preset ratios (25% to 99%) can be added. An added preset ratio can also be changed.



Preset ratios other than added preset ratios cannot be changed.

### Setting a Maximum Number of Copies

This is used to set the maximum number that can be entered for the number of copies (number of continuous copies). Any number from 1 to 999 can be specified.

### Initial Margin Shift Setting

This is used to set the default margin shift amount. Specify a value from 0 mm (0") to 20 mm (1") in increments of 1 mm (1/8") for both the front and reverse sides.

### Erase Width Adjustment

This is used to set the default erase width for erase copy. Specify a value from 0 mm (0") to 20 mm (1") in increments of 1 mm (1/8") for both edge erase and centre erase.

### Card Shot Settings

This is used to set the default original size for the card shot function.

Both the X (horizontal) and Y (vertical) dimensions of the original can be set from 25 mm (1") to 210 mm (8-1/2") in increments of 1 mm (1/8").

#### Fit to Page

Enable this setting to have the [Fit to Page] key always appear in the card shot screen.

### Initial Tab Copy Setting

This is used to set the default image shift width (tab width) for tab copying.

The default width can be set from 0 mm (0") to 20 mm (5/8") in increments of 1 mm (1/8").

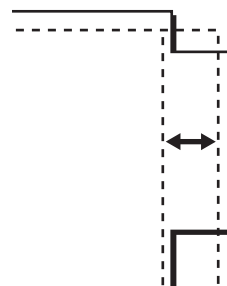

## Disabling Deletion of Job Programs

This is used to prohibit the deletion and changing of copy settings stored in job programs.

## Disabling of Bypass-Tray in Duplex Copy

This is used to prohibit the use of the bypass tray when making two-sided copies.

The bypass tray is often used to feed label sheets, transparency film, and other special media for which two-sided copying is prohibited. If a sheet of one of these special media enters the reversing unit, a misfeed or damage to the unit may result. If special media for which two-sided copying is prohibited is often used, it is recommended that you enable this setting.

## Disabling of Auto Paper Selection

This setting is used to disable the Auto Paper Selection function.

When this setting is enabled, automatic selection of paper that is the same size as the original on the document glass or in the automatic document feeder does not take place.

## Auto Selection Setting of Tray that is Supplied the Paper

When this setting is enabled and paper is loaded in a tray while the machine is on standby in copy mode, that tray is automatically selected.

## B/W 600dpi x 600dpi Scanning Mode for Document Feeder

The resolution for copying in black and white using the automatic document feeder can be changed from 600 x 400 dpi to 600 x 600 dpi (high quality mode).

When high quality mode is used, fine print and thin lines are reproduced with greater clarity, however, the scanning speed is slower.



When high quality mode is not selected, the following conditions must be satisfied in order to scan at 600 x 400 dpi and attain the fastest speed.

- The copy ratio must be set to 100%.
- Do not select a special mode that will change the ratio.
- [Copy of Copy] must not be enabled.
- Do not copy in black and white with the [COLOUR START] key.

## B/W Quick Scan from Document Glass

The resolution for copying in black and white using the document glass can be changed from 600 x 600 dpi to 600 x 300 dpi (high speed mode).

When high speed mode is selected, the first copy time is quicker, however, the copy image is not as clear.



When high speed mode is selected, the following conditions must be satisfied in order to scan at 600 x 300 dpi and attain the fastest speed.

- The copy ratio must be set to 100%.
- Do not select a special mode that will change the ratio.
- [Copy of Copy] must not be enabled.
- Do not copy in black and white with the [COLOUR START] key.

# Colour Adjustments

The following colour settings can be configured.

---

## Initial Colour Balance Setting

Colour balance values obtained using "Colour Balance" in the special modes can be stored in a program (1 to 48), and those values can be retrieved and stored as the initial colour balance setting\*. Use this feature when you want to repeatedly use a colour balance setting for a favourite colour or for correction when a change occurs in the colour balance.

\* Preset values displayed when you select "Colour Balance" in the special modes.

### Return to the Factory Default Setting

This returns the stored colour balance values to the factory default values (all colour balance values are "0" for the 8 levels of each colour).

---

## Auto Colour Calibration

This is used to perform automatic colour correction when the colour in colour copies is off. The machine prints a test patch, the test patch is scanned, and the colour is automatically corrected.

After the [Execute] key is touched and a test patch is printed, a message appears prompting you to begin automatic calibration. Place the test patch on the document glass as shown below (so that the thin line at the edge of the page is to the left).

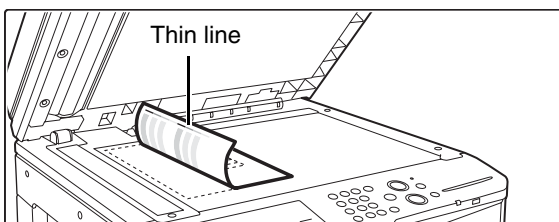

Lay copy paper (about five sheets) that is the same size as the test patch on top of the placed test patch, gently close the automatic document feeder, and touch the [Execute] key.



- Before executing Auto Colour Calibration, check to see if the registration adjustment is correct. If the registration adjustment is not correct, perform "[Registration Adjustment](#)" (page 7-68).
- If the colour is still off after performing Auto Colour Calibration, repeating Auto Colour Calibration once again may improve the colour.

# Network Settings

Network settings are described below. Touch the [Network Settings] key to configure the settings.



- \* Depending on your machine specifications, only the items under "General Setting" will be displayed.
- When settings are changed, the changes will take effect after the machine is restarted. To restart the machine see "[TURNING THE POWER ON AND OFF](#)" (page 1-15) in "1. BEFORE USING THE MACHINE".

## General Setting

### IPv4 Settings

When using the machine on a TCP/IP (IPv4) network, use this setting to configure the IP address of the machine. The settings are shown below.

#### IP Address

Enter the IP address of the machine.

#### IP Subnet Mask

Enter the IP Subnet Mask.

#### IP Gateway

Enter the IP Gateway address.

#### DHCP

Use this setting to have the IP address obtained automatically using DHCP (Dynamic Host Configuration Protocol). When this setting is enabled, it is not necessary to manually enter an IP address.



- If the machine will be used on a TCP/IP network, be sure to enable "[Enable TCP/IP](#)" below.
- If DHCP is used, the IP address assigned to the machine may change automatically. If the IP address changes, printing will not be possible.

### IPv6 Settings

When using the machine on a TCP/IP (IPv6) network, use this setting to configure the IP address of the machine. The settings are shown below.

#### Enable IPv6 Protocol

Enable this setting.

#### DHCPv6

Use this setting to have the IP address obtained automatically using DHCP (Dynamic Host Configuration Protocol). When this setting is enabled, it is not necessary to manually enter an IP address.

#### Manual Address

Enter the IP address of the machine.

#### Prefix Length

Enter the prefix length (0 to 128).

#### Default Gateway

Enter the IP Gateway address.



- If the machine will be used on a TCP/IP network, be sure to enable "[Enable TCP/IP](#)" below.
- If DHCP is used, the IP address assigned to the machine may change automatically. If the IP address changes, printing will not be possible.
- In an IPv6 environment, the machine can use LPD or IPP protocol.

### Enable TCP/IP

To use the machine on a TCP/IP network, this setting must be enabled.

### Enable NetWare

To use the machine on a NetWare network, this setting must be enabled.

### Enable EtherTalk

To use the machine on an EtherTalk network, this setting must be enabled.

### Enable NetBEUI

To use the machine on a NetBEUI network, this setting must be enabled.

### Reset the NIC

This returns all "Network Settings" to the factory default settings.

### Ping Command

Use this function to check if the machine can communicate with a computer on the network. Specify the IP address of the desired computer and touch the [Execute] key. A message will appear indicating whether or not the computer responded.



## Connection Type Switching

Specify the network connection type (wired or wireless).

For wireless communication via an access point, select "Wireless (Infrastructure Mode)". (A wired connection already being established at this time will be disabled.)

For wireless communication between devices without using an access point, select "Wired + Wireless (Ad-hoc Mode)".  
For wired connection only (without any wireless communication), select "Wired Only".



- If "Wired + Wireless (Ad-hoc Mode)" is selected, only the following functions and operations are available for devices connected to the machine:
  - Browsing Web pages of the machine
  - Printer functions
  - Scanner functions
  - Remote operations ("[REMOTE OPERATION OF THE MACHINE](#)" (Page 1-23))
  - SMB server functions
  - mDNS
- This function is not available in some countries and regions.

## Wireless Settings

Configure settings to connect the network using a wireless connection.

- **[Change Setting] key**

Tap this key to save an access point used to establish a wireless connection.

- **[Initialize] key**

Tap this key to reset wireless settings to the factory default.

If "Wired + Wireless (Ad-hoc Mode)" is selected in [Connection Type Switching], the following items can also be selected:

- **Selecting a connecting client**

- **[Opening] key**

Tap this key to release the IP address or MAC address.



This function is not available in some countries and regions.

## NAS Setting

(On the MX-2314N, the productivity kit is required.)

The "shared" folder of the MFP can be accessed as a network folder from a network PC.

Item	Description
shared	If the [Use of Storage] is set to [Allowed], you can use the "shared" folder as a network folder.



- This cannot be set on the machine. Set this in the network settings in the Web pages.
- We recommend you backup the data frequently.
- A maximum of 500 files can be stored in a folder.
- This function requires 120 GB of available HDD space.

---



---

# Printer Settings

Settings related to the printer function can be configured. Touch the [Printer Settings] key to configure the settings.

## Default Settings

Printer condition settings are described below.

---

### Prohibit Notice Page Printing

This setting is used to disable printing of notice pages.

---

### Prohibit Test Page Printing

This setting is used to disable printing of test pages. When this setting is enabled, "Printer Test Page" in the system settings cannot be used to print test pages.

---

### A4/Letter Size Auto Change

When printing an 8-1/2 x 11" (A4) size image, this setting allows A4 (8-1/2 x 11") size paper to be used if 8-1/2 x 11" (A4 ) size paper is not loaded.

---

### Print Density Level

This lightens or darkens the print density of colour and black and white images. The print density can be adjusted to five levels.

---

### CMYK Exposure Adjustment

This is used to adjust the density of cyan (C), magenta (M), Yellow (Y), and Black (K). The density of each colour can be adjusted to 17 levels.

---

### Bypass Tray Settings

#### Enable Detected Paper Size in Bypass Tray

This is used to prohibit printing when the paper size specified for a print job is different from the paper size inserted in the bypass tray.

#### Enable Selected Paper Type in Bypass Tray

This is used to prohibit printing when the paper type specified for a print job is different from the paper type inserted in the bypass tray.

#### Exclude Bypass-Tray from Auto Paper Select

When [auto] is selected for paper type selection, the bypass tray can be excluded from the trays that can be selected. This is recommended when special media is often placed in the bypass tray.

---

### Job Spool Queuing

(On the MX-2314N, the productivity kit is required.) When this function is enabled, received print jobs are displayed in the spool queue of the job status screen. The jobs are moved to the job queue after they have been analyzed by the machine. Multiple jobs that have not yet been analyzed can appear in the spool queue. When this function is disabled, received print jobs are displayed in the job queue without being displayed in the spool queue. However, when an encrypted PDF job is printed, the job appears in the spool queue.

---

### Disabling of USB Memory Direct Print

(On the MX-2314N, the productivity kit is required.) This setting is used to disable printing of files on USB memory. When this setting is enabled, "USB Memory" in the External Data Access screen cannot be used to print files.

---

### Disabling of Network Folder Direct Print

This setting is used to disable printing of files on network folders. When this setting is enabled, "Network Folder" in the External Data Access screen cannot be used to print files.



## Auto Colour Calibration

This is used to perform automatic colour correction when the colour in colour printing is off. The machine prints a test patch, the test patch is scanned, and the colour is automatically corrected.

After the [Execute] key is touched and a test patch is printed, a message appears prompting you to begin automatic calibration. Place the test patch on the document glass as shown below (so that the thin line at the edge of the page is to the left).

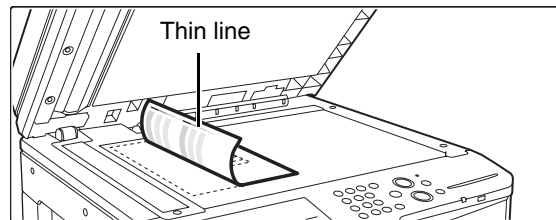

Lay copy paper (about five sheets) that is the same size as the test patch on top of the placed test patch, gently close the automatic document feeder, and touch the [Execute] key.



- Before executing Auto Colour Calibration, check to see if the registration adjustment is correct. If the registration adjustment is not correct, perform "[Registration Adjustment](#)" (page 7-68).
- If the colour is still off after performing Auto Colour Calibration, repeating Auto Colour Calibration once again may improve the colour.

# Image Send Settings

Settings related to the image send function (scan, Internet fax, etc.) can be configured. Touch the [Image Send Settings] key to configure the settings.



For explanations of settings related to the fax function, see "SYSTEM SETTINGS FOR FAX" (page 7-104).

## Operation Settings

The operation settings below apply to all image send functions.

### Other Settings

#### Default Display Settings

You can select one of 5 base screen types for the base screen that appears when the [IMAGE SEND] key is touched or when the [CLEAR ALL] (CA) key is pressed in image send mode.

- Address Book
- Scan
- Internet Fax
- Fax
- Data Entry

#### Hold settings for a while after scanning has been completed

Use this setting to hold the settings after scanning is completed (until Auto Clear Mode activates).

#### Address Book Default Selection

One of the following screens can be specified for the initial address book screen.

##### Tab Switch

- ABC
- Group

##### Address Type

- All
- E-mail
- FTP/Desktop
- Network Folder
- Internet Fax (Including Direct SMTP)
- Fax
- Group

#### Image Orientation

Sets the default image orientation.

#### Initial Resolution Setting

The following settings are available for the default resolutions of scan, Internet fax, and fax mode.

Scan : 100X100 dpi, 200X200 dpi, 300X300 dpi, 400X400 dpi, 600X600 dpi

Internet fax : 200X100 dpi

200X200 dpi

200X400 dpi

400X400 dpi

600X600 dpi

Half Tone

Fax: Standard

Fine

Super Fine

Ultra Fine

Half Tone

#### Apply the Resolution Set when Stored

When an image stored by document filing is used, this applies the resolution setting that was stored with the image.

#### Default Exposure Settings

This is used to set the default exposure settings for scanning a document in image send mode. Select [Auto] or [Manual]. When [Manual] is selected, the exposure can be set to one of 5 levels.

#### Default Original Image Type

Select the original type beforehand to enable transmission at a resolution suitable for the original (only in scan mode and USB memory mode).

The settings are shown below.

- Text/Printed Photo
- Text/Photo
- Text
- Photo
- Printed Photo
- Map



When the exposure is set to [Auto], a default original type cannot be selected.

#### Moiré Reduction

This reduces the moiré effect (line pattern) that occurs when printed matter is scanned (only in scan mode and USB memory mode).

## Must Input Next Address Key at Broadcast Setting

This setting is used to require that the [Next Address] key be touched before the next address is entered when performing a broadcast transmission.

When this setting is enabled, the [Next Address] key cannot be omitted even if the next address is entered with a one-touch key.

If a user attempts to enter the next address without touching the [Next Address] key, a double-beep alarm will sound and the entry will be rejected.

## Scan Complete Sound Setting

The scan complete sound can be selected.

## The Number of File Name/Subject/Body Keys Displayed Setting

This setting is used to select the number of file name / subject keys that are displayed in the screen. The number of keys can be set to 6, 12, or 18.

## The Number of Direct Address Keys Displayed Setting

Select 5, 10, or 15 for the number of one-touch keys that appear in the address book screen.

## Disable Switching of Display Order

This is used to prohibit changes to the order of display (search number order, ascending, descending) in the address book.

When this setting enabled, touching a tab on the address book screen does not change the order. The display order will remain fixed at the order that is in effect when this setting is enabled.

## Hold Setting for Received Data Print

This function holds received faxes and Internet faxes in memory without printing them. The faxes can be printed by entering a password (factory default setting: 0000) with the numeric keys.

### Password

When [Hold Setting for Received Data Print] is enabled, enter the password (4-digit number).



These settings can only be configured when there is no received data in the machine's memory (excluding data in a confidential or relay broadcast memory box).

## Default Verification Stamp

(When a stamp unit is installed.)

When the automatic document feeder is used, this setting can be enabled to have each original page stamped after it is scanned.

## Erase Width Adjustment

This is used to set the default erase width for erase function. Specify a value from 0" (0 mm) to 1" (20 mm) in increments of 1 mm (1/8") for both edge erase and centre erase.

## Settings to Disable Registration

This is used to prohibit the storing of destinations. Storing from the machine, storing from the Web page, and storing from a computer can each be separately prohibited.

## Disable Registering Destination from Operation Panel

This disables address control from the machine. Configure the setting for each of the following items:

- Group (Direct Entry)
- Group (Address Book)
- Individual

Select All: Select all items.

Clear Checked: Clear all selections.

## Disable Registering Destination on Web Page

(When network connection is enabled.)

This disables address control from the Web pages. Configure the setting for each of the following items:

- Group (Direct Entry)
- Group (Address Book)
- Individual

Select All: Select all items.

Clear Checked: Clear all selections.

---

## Disable Registration of Program

This prohibits the use of the address book when a program is stored.

Configure the setting for each of the following items:

- E-mail
- FTP
- Desktop
- Network Folder
- Internet Fax (Including Direct SMTP)
- Fax

Select All: Select all items.

Clear Checked: Clear all selections.

---

## Disable Registration of Memory Box

Disable all types of memory box registration.

Configure the setting for each of the following items:

Polling Memory, Confidential, Relay Broadcast (Direct Entry), Relay Broadcast (Address Book)

Select All: Select all items.

Clear Checked: Clear all selections.

---

## Disable Destination Registration Using Global Address Search

(When network connection is enabled.)

This disables address control from the global address search.

Configure the setting for each of the following items:

E-mail, Internet Fax, Fax

Select All: Select all items.

Clear Checked: Clear all selections.

---

## Disable Registration Using Network Scanner Tool

(When network connection is enabled.)

This disables address control from the Network Scanner Tool.

---

## Settings to Disable Transmission

These settings are used to disable the following transmission operations.

---

### Disable [Resend] on Image Send Mode

This setting disables the [Resend] key in the base screen of image send mode.

---

### Disable Selection From Address Book

This disables the selection of destinations from the Address Book.

Configure the setting for each of the following items:

- E-mail
- FTP
- Desktop
- Network Folder
- Internet Fax (Including Direct SMTP)
- Fax

Select All: Select all items.

Clear Checked: Clear all selections.

---

### Disable Direct Entry

This prohibits the direct entry of addresses.

Configure the setting for each of the following items:

- E-mail
- Network Folder
- Internet Fax (Including Direct SMTP)
- Fax

Select All: Select all items.

Clear Checked: Clear all selections.

---

### Disable PC-I-Fax Transmission

(When the Internet fax expansion kit is installed.)

(On the MX-2314N, the productivity kit is required.)

This prohibits PC-I-Fax transmission.

---

### Disable PC-Fax Transmission

(When facsimile expansion kit is installed.)

This prohibits PC-Fax transmission.

---

## Own Name and Destination Set

Use this setting to enter the Internet fax address, fax number of the machine and the name of the user.

---

### Sender Data Registration

Use this to store the sender name for fax and Internet fax, the sender number for fax, and the sender address for Internet fax.

The stored sender name and fax sender number or Internet sender address will be printed at the top of the received fax.

#### Sender Name

Enter the sender name. A maximum of 20 characters can be entered for the sender name.

#### Sender Fax Number

This is used to set the sender fax number.

To insert a pause between digits of the number, touch the [-] key.

To insert a space between digits of the number, touch the [Space] key.

#### I-Fax Own Address

Enter a default sender address (maximum of 56 characters).

---

### Registration of Own Name Select

Store sender names used in "Own Name Select " in the special modes. Up to 18 sender names can be stored.

#### Add New

Store a sender name. A maximum of 20 characters can be stored.

After entering a sender name, touch the [Store] key. The lowest unused registration number from 01 to 18 will be automatically assigned to the sender name. This number cannot be changed.

#### Sender Name List

This shows a list of the stored sender names.

A sender name can be selected to delete it.



# Scan Settings

Settings related to scanning can be configured.

## Other Settings

### Default Sender Set

The information stored here is used if you do not specify [Reply-To] in the send settings when performing Scan to E-mail.

#### Sender Name

Enter a default sender name (maximum of 20 characters).

#### Reply E-mail Address

Enter a default reply address (maximum of 64 characters).



If only the sender name is stored, it will not be used as sender information.

### Default Colour Mode Settings

Select a default colour mode setting for both colour and black & white in scan mode.

#### Black & White

Mono 2, Greyscale

#### Colour Mode

Auto (Mono 2, Greyscale\*), Full Colour

\* When scanning a black and white original with the colour mode set to [Auto].

#### Disable Change of B/W Setting in Auto Mode

This prohibits black & white settings from the base screen when the colour mode is set to Auto.

### Initial File Format Setting

This is used to set the default file format for Scan to E-mail and USB memory mode when the e-mail address is entered manually by touching the [Address Entry] key.

#### File Format

PDF, TIFF, JPEG\*, PDF/A, Encrypt PDF, XPS

\* When [Black & White] is selected, the format is [TIFF].

#### Black & White

Compression Mode: None, MH(G3), MMR(G4)

#### Colour/Greyscale

Compression Ratio: Low, Medium, High

#### Specified Pages per File

When multiple pages are scanned, this is used to generate a separate file for each scanned page (or specified number of pages).

When this setting is enabled, the number of pages per file can be specified.

#### Number of Pages

Any number of pages can be specified as the number of pages per file. This setting can be specified when [Specified Pages per File] is enabled.



When [JPEG] is selected for the file type, [Specified Pages per File] cannot be selected.

### Compression Mode at Broadcasting

This is used to set the compression mode for broadcasting using Scan to E-mail or Internet fax. The compression mode set here is used for all destinations regardless of their individual compression mode settings.

#### Black & White

MH(G3), MMR(G4)

#### Colour/Greyscale

Low, Medium, High

## Maximum Size of E-mail Attachments (E-mail)

To prevent the transmission of excessively large image files by Scan to E-mail, a file size limit can be set from 1 MB to 10 MB in increments of 1 MB. If the total size of the image files created by scanning the original exceeds the limit, the image files are discarded.

If you do not wish to set a limit, select [Unlimited].



This setting is linked to "[Maximum Size of E-mail Attachments](#)" (page 7-88) in the Internet Fax Send Settings.

## Maximum Size of Data Attachments (FTP/Desktop/Network Folder)

A limit can be set for the size of files that can be sent by Scan to FTP, Scan to Desktop, and Scan to Network Folder. Limits that can be selected are 50 MB, 150 MB, and 300 MB. If the total size of the image files created by scanning the original exceeds the limit, the image files are discarded.

If you do not wish to set a limit, select [Unlimited].



When a broadcast transmission is performed that includes both e-mail and Internet fax destinations, the limit set in "[Maximum Size of E-mail Attachments \(E-mail\)](#)" (page 7-86) is given priority.

## Bcc Setting

### Enable Bcc

Enable this setting if you wish to use Bcc delivery. When the setting is enabled, the [Bcc] key will appear in the image send address book screen.

### Display Bcc Address on the Job Status Screen

This displays Bcc addresses on the job status screen and address list tab.

## Disable Scan Function

This is used to disable PC scan and USB memory scan. When these modes are disabled, they are greyed out when the mode is changed in the base screen.

## Pre-Setting Mail Signature

A signature can be automatically appended to the end of the body text of e-mail. This is convenient when it is a corporate policy to append a specific signature at the end of e-mail.

The mail signature to be appended is configured in the Web pages. This setting simply enables or disables the signature.



This setting is linked to "[Pre-Setting Mail Signature](#)" (page 7-88) in the Internet Fax Initial Settings.

## Default Address Setting

A default address can be stored that makes it possible to transmit by simply pressing the [COLOUR START] key or the [BLACK & WHITE START] key without specifying an address. When "Apply E-mail address of the user for login." is selected, the e-mail address of the currently logged-in user can be set as the default address.



- When this setting is enabled, the base screen changes to scan mode.
- Only a single default address can be set for Scan to E-mail, Scan to FTP, Scan to Desktop, and Scan to Network Folder.

If [Apply E-mail address of the user for login.] is selected, the following settings can be configured.

### Apply also for Fax/I-Fax Screen\*

If this checkbox is set to , the default address (E-mail address of the user that has logged in) is applied even when the mode is switched to fax or Internet fax mode. If this checkbox is set to , the default address (E-mail address of the user that has logged in) is released when the mode is switched to fax or Internet fax mode.

### Allow Cancel

If this checkbox is set to , the default address (E-mail address of the user that has logged in) can be released in the address list screen.

\* When the fax expansion kit or Internet fax expansion kit is installed.

# I-Fax Settings

 These settings can be configured when the Internet fax expansion kit is installed. (On the MX-2314N, the productivity kit is required.)

## I-Fax Default Settings

These settings are used to configure the default settings for Internet fax.

### Auto Wake Up Print

When the [POWER] key () is "off" (but the main power switch is "on") and an Internet fax is received, this function activates the machine and prints the fax.

When this function is disabled, received Internet faxes are not printed until the [POWER] key () is switched "on".

### Compression Setting

This is used to set the default compression mode for Internet fax transmission.

The settings are shown below.

- MH (G3)
- MMR (G4)

### Speaker Volume Setting

This is used to adjust the volume of fax receive signals and communication error signals heard through the speaker.

A fax receive signal sounds after the machine checks the mail server and retrieves received faxes. A communication error signal sounds when a delivery failed e-mail is received from the destination Internet fax machine.

### Original Print on Transaction Report

When a transaction report is printed, this is used to print part of the first page of the transmitted original on the transaction report. Select one of the settings below.

- Print Out All Report
- Print Out Error Report Only
- No Printed Report

This setting will not be effective if "[Transaction Report Print Select Setting](#)" below is set to "No Printed Report".

### Transaction Report Print Select Setting

This is used to select whether or not a transaction report will be printed, and if printed, the condition for being printed. Select a setting for each of the following operations:

#### Single Sending

- Print Out All Report
- Print Out Error Report Only
- No Printed Report

#### Broadcasting

- Print Out All Report
- Print Out Error Report Only
- No Printed Report

#### Receiving

- Print Out All Report
- Print Out Error Report Only
- No Printed Report

When a transaction report is printed, you can have part of the first page of the transmitted original printed on the transaction report. For more information, see "[Original Print on Transaction Report](#)".

## Activity Report Print Select Setting

This is used to have the Image Sending Activity Report stored in the machine's memory automatically print at specified times.

The Image Sending Activity Report can be set to automatically print each time the number of transactions reaches 201, and it can also be set to automatically print at a specified time (once a day only). (The settings can be simultaneously enabled.)



- If you only enable the [Print Daily at Designated Time] setting  and the number of recorded transactions exceeds 201 before the specified time, each new transaction will delete the oldest transaction (the oldest transaction will not be printed).
- The Image Sending Activity Report can also be printed manually. See "[List Print \(Administrator\)](#)" (page 7-94) in the system settings (administrator).

## Body Text Print Select Setting

Image files attached to Internet faxes are normally printed. This setting can be enabled to also have the e-mail body text (subject and message) printed. This setting also applies to printing of the body text of e-mail messages without file attachments.



A maximum of 5 pages of body text can be printed.

## Pre-Setting Mail Signature

A signature can be automatically appended to the end of the body text of e-mail. This is convenient when it is a corporate policy to append a certain signature at the end of e-mail.

The mail signature to be appended is configured in the Web pages. This setting simply enables or disables the signature.



This setting is linked to "[Pre-Setting Mail Signature](#)" (page 7-86) in the Scan Settings.

## I-Fax Send Settings

I-Fax Send Settings are described below.

### I-Fax Reception Report On/Off Setting

This setting is used to request a reception report when an Internet fax is sent.

The reception report is returned to the sender address stored in "[Own Name and Destination Set](#)" (page 7-84).

### I-Fax Reception Report Request Timeout Setting

The duration of time that the machine will wait for a reception report from the destination machine can be set by any number from 1 hour to 240 hours in increments of 1 minute.



This setting is only effective when "[I-Fax Reception Report On/Off Setting](#)" is enabled.

### Number of Resend Times at Reception Error

The number of resend attempts when an error message is received from an I-Fax recipient can be set to any number from 0 to 15.



This setting is only effective when "[I-Fax Reception Report On/Off Setting](#)" is enabled.

### Maximum Size of E-mail Attachments

To prevent the transmission of excessively large image files by Internet fax, a file size limit can be set from 1 MB to 10 MB in increments of 1 MB. If the total size of the image files created by scanning the original exceeds the limit, the image files are discarded.

If you do not wish to set a limit, select [Unlimited].



- This setting is linked to "[Maximum Size of E-mail Attachments \(E-mail\)](#)" (page 7-86) in the Scan Settings.
- This setting does not apply to the limit for direct SMTP transmission.

## Rotation Sending Setting

When transmitting an image that is one of the following sizes, this function rotates the image counterclockwise 90 degrees. (The setting can be configured separately for each size.)

A4, B5R, A5R, 8-1/2" x 11", 5-1/2" x 8-1/2"R, 16K



A4R and 8-1/2" x 11"R size images are not rotated.

## Printing Page Number at Receiver

When the transmitted image is printed by the receiving machine, the page number can be added to the top of each printed page.

## Recall in Case of Line Busy

(This setting is only effective for Direct SMTP transmission.)

This program is used to set the number of recall attempts and the interval between recall attempts when a transmission is not successful due to the line being busy or other reason.

### Number of Times to Recall When Line is Busy

This setting specifies whether or not recalling is performed when the line is busy. When recalling is performed, you can set the number of recall attempts. Any number from 0 to 15 can be selected.

### Interval to Wait Between Recall Attempts (min.) When Line is Busy

The interval between recall attempts can be set. Any number of minutes from 1 to 15 can be selected.

## Recall in Case of Communication Error

(This setting is only effective for Direct SMTP transmission.)

This determines how many times your machine will automatically re-attempt the call if a fax transmission fails due to a communication error.

### Number of Times to Recall in Case of Error

Specify how many times the machine will re-attempt the call when a communication error occurs. Any number from 0 to 15 can be selected.

### Interval to Wait Between Recall Attempts (min.) in Case of Error

The interval between recall attempts can be set. Any number of minutes from 1 to 15 can be selected.

## I-Fax Receive Settings

I-Fax Receive Settings are described below.

## Auto Receive Reduce Setting

When a fax is received that includes printed information such as the sender's name and address, the received image is slightly larger than the standard size. This setting is used to automatically reduce the image to fit the standard size.



- If Auto Receive Reduce is disabled, the edges of the image outside the standard size will be cut off. However, the image will be clearer because it will be printed at the same size as the original.
- Standard sizes are sizes such as A4 and B5 (8-1/2" x 11" and 8-1/2" x 5-1/2").

## Duplex Reception Setting

This is used to select whether or not received faxes are printed on both sides of the paper. When this setting is enabled and a fax consisting of 2 or more pages is received (the pages must be the same size), the pages are printed on both sides of the paper.

## Set Address for Data Forwarding

When the machine is unable to print a received fax, the fax can be forwarded to another machine. This setting is used to configure the address of the other machine.

### Forwarding to

Enter the forwarding address (maximum of 64 characters).

### Direct SMTP

Select this to enable forwarding when direct SMTP is used.

### Add Hostname or IP Address Too

Select this to separately enter a host name or IP address.

### Hostname or IP Address

When "Add Hostname or IP Address Too" is enabled, use this setting to enter the host name or IP address (maximum of 64 characters).



Multiple forwarding addresses cannot be stored.

## Letter Size RX Reduce Print

This program is not available in Canada and Philippines. When a letter-R (8-1/2" x 11"R) size fax is received, this setting reduces the fax to A4R size.

 When this setting is enabled, A4R size faxes are also reduced.

## Receiving Date & Time Print

Enable this setting to have the date and time of reception printed.

Select [Inside the Received Image] or [Outside the Received Image] for the position where the date and time is printed.

When [Inside the Received Image] is selected, the date and time of reception is printed on the received image. When [Outside the Received Image] is selected, the received image is reduced and the date and time of reception is printed in the blank area that results.

 [Outside the Received Image] cannot be selected for the reception date and time print setting when "Auto Receive Reduce Setting" (page 7-89) is not enabled.

## A3 RX Reduce

When an A3 size fax is received, this function reduces the fax to ledger (11" x 17") size.

 When this setting is enabled, ledger (11" x 17") size faxes are also reduced.

## POP3 Communication Timeout Setting

The duration of time the machine waits until stopping reception when a response is not received from the mail server (POP3 server) can be set from 30 to 300 seconds in increments of 30 seconds.

## Reception Check Interval Setting

This is used to specify the interval at which the machine automatically checks the mail server (POP3 server) for received Internet faxes. The interval can be set from 0 minutes to 8 hours in increments of 1 minute.

When 0 hours 0 minutes is specified, the machine does not automatically check the mail server for received Internet faxes.

 The machine also checks the mail server (POP3 server) for received Internet faxes when the main power is switched on. (Except when 0 hours 0 minutes is specified.)

## I-Fax Output Setting

This sets the output tray for received Internet faxes. The items that appear will vary depending the machine configuration.

## Allow/Reject Mail or Domain Name Setting

This setting is used to allow or refuse reception from specified addresses/domains.

Item	Description
Reject Reception	Reception from the stored address/domain is not allowed.
Allow Reception	Reception from the stored address/domain is allowed.
All Invalid	Reception from any address and domain is allowed, regardless of whether or not any addresses or domains have been stored.
Add New	Use this to add a new address or domain (maximum of 50) from which reception is to be rejected or allowed. Enter the address/domain (maximum of 64 characters) and touch the [Store] key. If the first character of the entry is not "@", the entry is identified as an address. If the first character is "@", the entry is identified as a domain. (xxx@xx.xxx.com is treated as an address, and @xx.xxx.com is treated as a domain.) Storing an address specifies only that address. Storing a domain specifies all addresses that include that domain.
Registered address or domain list	This shows a list of the stored addresses and domains. An address or domain can be selected in this screen to delete it from the list.

 When there are no stored anti junk mail addresses or domains, only the [Add New] key can be selected.

# Document Filing Settings

(On the MX-2314N, the productivity kit is required.)

Document filing settings are described below. Touch the [Document Filing Settings] key to configure the settings.

## Other Settings

### Default Mode Settings

This is used to specify which mode, Sharing or Confidential, is used as the default mode when storing a file.

When [Confidential Mode] is selected, the [Confidential] checkbox in the information screen for filing will be selected .

### Sort Method Setting

This setting is used to select the order of display of files stored in the Main Folder, Custom Folder, and Quick File Folder. Select one of the following settings:

- File Name
- User Name
- Date

### Administrator Authority Setting

For files and user folders that have a password, this setting allows the administrator password to be entered instead of the password when accessing the file or folder.

The administrator can also change the password.

### Delete All Quick Files

This function deletes all files except protected files from the Quick File Folder.

#### Delete Now

Touch this key to start deletion of all files immediately.

#### Delete Quick Files at Power Up

This is used to automatically delete all files in the Quick File Folder (with the exception of protected files) when the [POWER] key (Ⓢ) is turned "on".

### Default Colour Mode Settings

This sets the default settings for black & white and colour when Scan to HDD is used.

The settings are shown below.

#### Colour

Auto, Full Colour, 2 Colour

#### Black & White

Mono 2, Greyscale

### Default Exposure Settings

Default exposure settings for document filing can be configured. Select [Auto] or [Manual]. If you select [Manual], set the exposure to one of 5 levels.

#### Default Original Image Type

Select the original type beforehand to enable scanning at a resolution suitable for the original.

The settings are shown below.

- Text/Printed Photo
- Text/Photo
- Text
- Photo
- Printed Photo
- Map



When the exposure is set to [Auto], a default original type cannot be selected.

#### Moiré Reduction

This reduces the moiré effect (line pattern) that occurs when printed matter is scanned.

### Initial Resolution Settings

One of the following resolutions can be selected for the default resolution for transmission.

- 100X100 dpi
- 200X200 dpi
- 300X300 dpi
- 400X400 dpi
- 600X600 dpi

---

## Colour Data Compression Ratio Setting

[Low], [Medium], or [High] can be selected for the default compression ratio for transmission of a stored colour file.

---

## Scan Complete Sound Setting

This setting adjusts the volume of the beep that sounds when scanning ends. The beep can also be turned off.

---

## Default Output Tray

(When the exit tray unit is installed.)

This setting is used to select the default output tray for printing a file stored by Scan to HDD.  
The items that appear will vary depending the machine configuration.

---

## Disable Stamp for Reprinting

When a stored file is retrieved and printed, this setting prohibits the selection of a "Stamp" setting in the special modes. If a stamp setting is already selected, it will not be possible to change the stamp setting.

This function can be used to prevent inconsistencies in the printed information, such as that of the original date in the file and the date the file is retrieved and printed.

---

## Batch Print Settings

When printing files by batch printing, this setting is used to prohibit the selection of the [All Users] key and the [User Unknown] key in the user selection screen.

---

## Erase Width Adjustment

This is used to set the default erase width for erase function. Specify a value from 0 mm (0") to 20 mm (1") in increments of 1 mm (1/8") for both edge erase and centre erase.

---

## Card Shot Settings

This is used to set the default original size for the card shot function.

Both the X (horizontal) and Y (vertical) dimensions of the original can be set from 25 mm (1") to 210 mm (8-1/2") in increments of 1 mm (1/8").

### Fit to Store Size

Enable this setting to have the [Fit to Store Size] key always appear in the card shot screen.



## Document Output Options

The use of a stored file can be allowed or prohibited by operation type and by the mode from which the file was stored.



The items that appear will vary depending on the functions that have been added to the machine.

Item	Description
Printer	For each mode, select whether or not printing of stored files is allowed.
Scan Send	For each mode, select whether or not scan send of stored files is allowed.
Internet Fax Send (Incl. PC-I-Fax)	For each mode, select whether or not I-Fax transmission of stored files is allowed.
Fax Send (Incl. PC-Fax)	For each mode, select whether or not fax transmission of stored files is allowed.

## Automatic Deletion of File Settings

Time and folder settings can be configured to have files in specified folders (stored by document filing) automatically deleted at a specified time. Up to 3 settings can be stored to be automatically deleted.

The procedure for using this function is as follows:

- (1) Select one of [Setting 1] to [Setting 3].
- (2) Set the time and date of automatic deletion.
- (3) Select the desired folder.
- (4) Specify whether or not protected files and confidential files are to be deleted.
- (5) Enable the stored settings.

Item	Description
Schedule	Select the automatic deletion cycle. <ul style="list-style-type: none"> <li>• Every Day: Auto deletion every day at the specified time.</li> <li>• Every Week: Auto deletion at the specified time on the specified day of the week.</li> <li>• Every Month: Auto deletion at the specified time on the specified day of the month.</li> </ul>
Folders	To select the folder separately, select [Folder Select] and select the desired folder. To select all folders, including the folder currently being created, select [All Folders (Including folders registered hereafter)].
Delete Protected File	Enable this setting to include protected files in the deletion.
Delete Confidential File	Enable this setting to include confidential files in the deletion.

### Delete Now

When this is executed with a folder selected, all files in the folder will be immediately deleted regardless of the date and time setting.

---

---

# List Print (Administrator)

This is used to print lists and reports that are only for use by the administrator of the machine. Touch the [List Print (Administrator)] key to configure the settings.

---

## Administrator Settings List

Lists of the administrator settings for the following modes can be printed.

- Copy
- Print
- Image Send
- Document Filing  
(On the MX-2314N, the productivity kit is required.)
- Security
- Common
- All Administrator Settings List

---

## Image Sending Activity Report

The following Image Sending Activity Reports can each be separately printed.

- Image Sending Activity Report (Scan)
- Image Sending Activity Report (Internet Fax)
- Image Sending Activity Report (Fax)

---

## Data Receive/Forward List

The following lists showing reception settings and forwarding settings can be printed.

- Anti Junk Fax Number List
- Anti Junk Mail/Domain Name List
- Inbound Routing List
- Document Admin List

---

## Web Settings List

**(When network connection is enabled.)**

This prints a list of the settings that are configured in the Web pages.

---

## Metadata Set List

**(When the application integration module is installed.)**

(On the MX-2314N, the productivity kit is required.)

This prints a list of the metadata sets stored in the Web pages.

# Security Settings

The following settings are related to security. Touch the [Security Settings] key to configure the settings.

## SSL Settings

SSL can be used for data transmission over a network. SSL is a protocol that enables the encryption of information communicated over a network. Encrypting data makes it possible to transmit and receive sensitive information safely.

SSL can be enabled for the following protocols:

### Server Port

- **HTTPS:** Apply SSL encryption to HTTP communication.
- **IPP-SSL:** Apply SSL encryption to IPP communication.
- **Redirect HTTP to HTTPS in Device Web Page Access:**  
When this setting is enabled, all communication that attempts to access the machine by HTTP is redirected to HTTPS.

### Client Port

- **HTTPS:** Apply SSL encryption to HTTP communication.
- **FTPS:** Apply SSL encryption to FTP communication.
- **SMTP-SSL:** Apply SSL encryption to SMTP communication.
- **POP3-SSL:** Apply SSL encryption to POP3 communication.
- **LDAP-SSL:** Apply SSL encryption to LDAP communication.

### Level of Encryption

The encryption strength can be set to one of three levels.

## IPsec Settings

IPsec can be used for data transmission/reception on a network. When IPsec is used, data can be sent and received safely without the need to configure settings for IP packet encryption in a Web browser or other higher-level application.

This setting is only used to enable or disable IPsec; detailed IPsec settings are configured in the Web pages.

Note the following points when enabling IPsec:

- A certain amount of time may be needed for the setting to be updated. During this time, it will not be possible to connect to the machine.
- If the settings in the Web page are not configured correctly, it will not be possible to connect to the machine, and printing, scanning, and Web page display may not be possible. In this event, disable the setting at the machine and then correct the settings in the Web page.

## IEEE802.1X Setting

IEEE802.1X can be used to authenticate a user to allow use of the machine.

IEEE802.1X protocol defines port-based authentication for both wired and wireless networks.

Use IEEE802.1X authentication to allow only authenticated devices to use network, and protect against network abuse by third parties.

This setting is only used to enable or disable IEEE802.1X; detailed IEEE802.1X settings are configured in the Web pages.

Some Web page settings may not allow connection to the machine, or the settings may not allow printing, scanning, or Web page display. In this case, deselect this setting and change the Web page settings.

## Data Clearance Settings

Enabling this function activates the following security functions on the machine.

(On the MX-2314N, the productivity kit is required.)



Use caution, as this function cannot be canceled once enabled.

- The image data generated in each job is encrypted.
- You can automatically clear the encrypted data in the memory or on the hard disk drive after completing each job.
- If you enter the password below incorrectly three consecutive times, the input operation becomes locked for five minutes.
  - Administrator password/user password to use when the user authentication function is not set
  - Password for confidential folders and files in document filing
  - Password for printing encrypted PDF for direct printing\*
    - \* This data cannot be used if you enter the password incorrectly three consecutive times.
  - Password for FTP pull print

To enable these features, touch [OK] when a message for confirming whether or not to enable the features appears, and enter the same code as that shown on the "Security code input" screen. Touch the [Execute] key. Then restart the device.

After restarting, you can select from one to seven times for the "Clearance Time Settings".



A high clearance time setting will increase security, however, the time will take longer to clear. It is recommended that you set it to an appropriate setting according to your usage.

## Release Lock on File/Folder Operation

This function is used to release document filing folders and files and encrypted PDF files, that are locked due to the entry of an incorrect password.

Touch the [Release Lock on File/Folder Operation] key and then the [Release] key to release all locked items.

After this is done, the items can be manipulated. When no items are locked, the [Release Lock on File/Folder Operation] key is grayed out.

## Initialize Private Data/Data in Machine

The system-set values can be restored to the factory default state after eliminating the data stored in the machine.

# Enable/Disable Settings

The following settings are used to prohibit the use of certain functions. Touch the [Enable/Disable Settings] key to configure the settings.

 The Enable/Disable Settings control the same parameters as the enable/disable settings in other settings. The settings are linked together (changing one setting changes the other).

## Printer Condition Settings

### Disable Blank Page Print

This setting is used to disable blank page printing.

## User Control

### Disabling of Printing by Invalid User

Printing by users whose information is not stored in the machine, such as printing without entering valid user information in the printer driver or printing of a file on an FTP server from the Web pages, can be prohibited.

## Operation Settings

### Cancel Auto Clear Timer

This setting is used to disable Auto Clear.

### Disabling of Job Priority Operation

The job priority function can be disabled. When this is done, the [Priority] key will not appear in the job status screen.

### Disabling of Bypass Printing

This setting is used to disable bypass printing (printing other jobs ahead of a job that has been stopped\* because the paper required for the job is not in any of the trays).

\* This does not include cases where the paper ran out during the job.

### Disable Auto Key Repeat

This setting is used to disable the auto key repeat function.

### Disabling of Clock Adjustment

This setting is used to prohibit changing of the date and time.

### Disabling of Covers/Inserts Mode

This setting is used to prohibit the use of the covers and inserts function.

## Device Control

### Disabling of Document Feeder

Use this setting to prohibit the use of the automatic document feeder, such as when the feeder malfunctions. (When the setting is enabled, scanning is still possible using the document glass.)

### Disabling of Duplex

This is used to disable two-sided printing, such as when the duplex module malfunctions.

### Disabling of Optional Paper Drawer

(When an optional paper drawer is installed.) This setting is used to disable the optional paper drawer, such as when it malfunctions.

### Disabling of Tray Setting

This setting is used to prohibit tray settings.

### Disabling of Finisher

(When a finisher is installed.) This setting is used to disable the finisher, such as when the unit malfunctions.

### Disabling of Offset

This setting is used to disable the offset function.

### Disabling of Stapler

(When a finisher is installed.) This setting is used to prohibit stapling, such as when the stapler unit of the finisher malfunctions.

### Disabling of Punch

(When a punch module is installed.) This setting is used to prohibit punching, such as when the punch module of the finisher malfunctions.

**Disabling of Colour Mode**

(When a colour-related problem has occurred.)

When a colour-related problem has occurred and printing is not possible, the use of colour mode can be temporarily prohibited. Black & white printing will still be allowed.



This function is only for use as an emergency measure. Once this setting is enabled, only a service technician can cancel the setting. Promptly contact your dealer or nearest SHARP service department to have a service technician cancel the setting and resolve the colour-related problem.

**Disabling of Master Machine Mode**

This prohibits the use of the machine as a master machine for tandem printing.

(Normally this setting is not necessary.)

**Disabling of Slave Machine Mode**

This prohibits the use of the machine as a slave machine for tandem printing.

(Normally this setting is not necessary.)

---

**Copy Function Settings****Disabling Deletion of Job Programs**

This is used to prohibit the deletion and changing of copy settings stored in job programs.

**Disabling of Bypass-Tray in Duplex Copy**

This is used to prohibit the use of the bypass tray when making two-sided copies.

The bypass tray is often used to feed label sheets, transparency film, and other special media for which two-sided copying is prohibited. If a sheet of one of these special media enters the reversing unit, a misfeed or damage to the unit may result. If special media for which two-sided copying is prohibited is often used, it is recommended that you enable this setting.

**Disabling of Auto Paper Selection**

This setting is used to disable the Auto Paper Selection function.

When this setting is enabled, automatic selection of paper that is the same size as the original on the document glass or in the automatic document feeder does not take place.

---

**Printer Settings****Prohibit Notice Page Printing**

This setting is used to disable printing of notice pages.

**Prohibit Test Page Printing**

This setting is used to disable printing of test pages.

When this setting is enabled, "Printer Test Page" in the system settings cannot be used to print test pages.

**Exclude Bypass-Tray from Auto Paper Select**

When [Auto] is selected for paper type selection, the bypass tray can be excluded from the trays that can be selected. This is recommended when special paper is often placed in the bypass tray.

**Disabling of USB Memory Direct Print**

(On the MX-2314N, the productivity kit is required.)

This setting is used to disable printing of files on USB memory.

When this setting is enabled, "USB Memory" in the External Data Access screen cannot be used to print files.

**Disabling of Network Folder Direct Print**

This setting is used to disable printing of files on network folders.

When this setting is enabled, "Network Folder" in the External Data Access screen cannot be used to print files.

---

**Image Send Settings****Other Disabling****Disable Switching of Display Order**

This is used to prohibit changes to the order of display (search number order, ascending, descending) in the address book.

When this setting is enabled, touching a tab on the address book screen does not change the order. The currently selected display order will be the order that is used after the setting is selected.

**Disable Scan Function**

This is used to disable PC scan and USB memory scan. When these modes are disabled, they are greyed out when the mode is changed in the base screen.

**Settings to Disable Registration****Disable Registering Destination from Operation Panel**

This disables address control from the machine.

Configure the setting for each of the following items:

- Group (Direct Entry)
- Group (Address Book)
- Individual

Select All: Select all items.

Clear Checked: Clear all selections.

**Disable Registering Destination on Web Page**

(When network connection is enabled.)

This disables address control from the Web pages.

- Group (Direct Entry)
- Group (Address Book)
- Individual

Select All: Select all items.

Clear Checked: Clear all selections.

**Disable Registration of Program**

This prohibits the use of the address book when a program is stored.

Configure the setting for each of the following items:

- E-mail
- FTP
- Desktop
- Network Folder
- Internet Fax (Including Direct SMTP)
- Fax

Select All: Select all items.

Clear Checked: Clear all selections.

**Disable Registration of Memory Box**

Disable all types of memory box registration.

Configure the setting for each of the following items:

Polling Memory, Confidential, Relay Broadcast (Direct Entry), Relay Broadcast (Address Book)

Select All: Select all items.

Clear Checked: Clear all selections.

**Disable Destination Registration Using Global Address Search**

(When network connection is enabled.)

This disables address control from the global address search.

Configure the setting for each of the following items:

E-mail, Internet Fax, Fax

Select All: Select all items.

Clear Checked: Clear all selections.

**Disable Registration Using Network Scanner Tools**

(When network connection is enabled.)

This disables address control from the Network Scanner Tool.

**Settings to Disable Transmission**

These settings are used to disable the following transmission operations.

**Disable [Resend] on Image Send Mode**

This setting disables the [Resend] key in the base screen of image send mode.

**Disable Selection from Address Book**

This disables the selection of destinations from the address book.

Configure the setting for each of the following items:

- E-mail
- FTP
- Desktop
- Network Folder
- Internet Fax (Including Direct SMTP)
- Fax

Select All: Select all items.

Clear Checked: Clear all selections.

**Disable Direct Entry**

This prohibits the direct entry of addresses.

Configure the setting for each of the following items:

- E-mail
- Network Folder
- Internet Fax (Including Direct SMTP)
- Fax

Select All: Select all items.

Clear Checked: Clear all selections.

**Disable PC-I-Fax Transmission**

(When the Internet fax expansion kit is installed.)

(On the MX-2314N, the productivity kit is required.)

This prohibits PC-I-Fax transmission.

**Disable PC-Fax Transmission**

(When the facsimile expansion kit is installed.)

This prohibits PC-Fax transmission.

---

**Document Filing Settings**

(On the MX-2314N, the productivity kit is required.)

**Disable Stamp for Reprinting**

When a stored file is retrieved and printed, this setting prohibits the selection of a "Stamp" setting in the special modes. If a stamp setting is already selected, it will not be possible to change the stamp setting.

This function can be used to prevent inconsistencies in the printed information, such as that of the original date in the file and the date the file is retrieved and printed.

**Batch Print Settings**

When printing files by batch printing, this setting is used to prohibit the selection of the [All Users] key and the [User Unknown] key in the user selection screen.

---



---

# Change Administrator Password

This is used to change the administrator password. Touch the [Change Administrator Password] key to change the password.

When changing the password, be sure to remember the new password.  
It is recommended that you periodically change the administrator password.

## Password

Enter the new administrator password (5 to 32 characters).

## Password (confirmation)

Enter the new password once again for confirmation purposes.



For the factory default administrator password, see "TO THE ADMINISTRATOR OF THE MACHINE" in the Start Guide.

---



---

# Product Key

The procedures for entering the product keys of the expansion kits are explained below. Touch the [Product Key] key to configure the settings.



- It may not be possible to use some settings, depending on the peripheral devices installed.
- For the product key to be entered, contact your dealer.

---

## Serial Number

This displays the serial number that is required to obtain the product key.

---

## Font Kit for Barcode

Enter the product key of the barcode font kit.

---

## PS3 Expansion Kit

Enter the product key of the PS3 expansion kit.

---

## Internet Fax Expansion Kit

Enter the product key of the Internet fax expansion kit.

---

## E-mail Alert and Status

Enter the product key of e-mail alert and status.

---

## Application Integration Module

Enter the product key of the application integration module.

---

## Application Communication Module

Enter the product key of the application communication module.

---

## External Account Module

Enter the product key of the external account module.

---

## XPS Expansion Kit

Enter the product key of the XPS expansion kit.



# Data Backup

Settings and information stored in the machine can be saved to USB memory.



- This function can be enabled when a USB memory device is installed.
- This function cannot be used while the system settings are in use, while a job is being executed, or when there is a reserved job.
- For machines for which data can be imported, contact your SHARP dealer or nearest authorised service representative.

## Storage Backup

Address book information and user information stored in the machine can be saved to and retrieved from USB memory.

### Export

This exports data to USB memory.

### Import

Use "Export" to import data written to USB memory back into the machine.

## Device Cloning

Device cloning is used to save the machine's setting information in XML format and copy the information to another machine.

This function saves you the trouble of repeatedly configuring the same settings in multiple machines.

### Export

This exports data to USB memory.

### Import

Use "Export" to import data written to USB memory back into the machine.



The following data is not copied when device cloning is performed:

- List print and fax forwarding items.
- Count and device status display items.
- IP address of the machine, device name, administrator password, sender names for image send, and other information that is specific to the machine.
- Screen contrast, colour adjustment and other adjusted values particular to each hardware device.

---

---

# Storing/Calling of System Settings

The current system settings can be stored, previously stored system settings can be retrieved, and the factory default system settings can be restored. Touch the [Storing/Calling of System Settings] key to configure the settings.

---

## Restore Factory Defaults

This is used to return the system settings to the factory default settings. If you wish to create a record of the current settings before restoring the factory default settings, print the current settings using "[List Print \(Administrator\)](#)" (page 7-94) in the system settings (administrator).



When settings are changed, the changes will take effect after the machine is restarted. To restart the machine see "[TURNING THE POWER ON AND OFF](#)" (page 1-15) in "1. BEFORE USING THE MACHINE".

---

## Store Current Configuration

This is used to store the currently configured system settings. The stored settings will be retained even if the [POWER] key (⏻) is turned off. To retrieve the stored settings, use "[Restore Configuration](#)" below.

### Items not stored

- Network Settings: These are not stored as unexpected settings may cause damage to the network.
- Product Keys: Product Keys are not stored as reissue of keys may be necessary.

---

## Restore Configuration

Use this to restore settings stored with "[Store Current Configuration](#)".

The current settings will change to the retrieved settings.

# Sharp OSA Settings



These settings can be used when the external account module or application communication module is available. (On the MX-2314N, the productivity kit is required.)

## External Account Setting

### External Account Control

When this setting is enabled, the machine enters external totaling mode and the totaling function can be used via an external account application.

### Enable Authentication by External Server

When this setting is enabled, the machine enters external authentication mode. Access to the machine is controlled by an external application.



When settings are changed, the changes will take effect after the machine is restarted. To restart the machine see "[TURNING THE POWER ON AND OFF](#)" (page 1-15) in "1. BEFORE USING THE MACHINE".

## USB Driver Settings

When installing the external account module or application communication module, set the driver of the USB device to be connected.

### External Keyboard

Select whether the internal or external driver for the external keyboard is used.

### USB Memory

Select whether the internal or external USB memory driver is used.

### Level of Encryption

Select the level of encryption for communication using the external driver.

Select from none, AES-128 or AES-256.



- When the external driver is selected, the connected USB device is treated as not connected and cannot be used.
- When settings are changed, the changes will take effect after the machine is restarted. To restart the machine see "[TURNING THE POWER ON AND OFF](#)" (page 1-15) in "1. BEFORE USING THE MACHINE".

## Job Priority Preference

Set the playing speed of the animation in the Sharp OSA application.

The following settings can be configured.

- Printing
- Balanced
- LCD Animation Playback



When "LCD Animation Playback" or "Balanced" is selected, the machine's job processing speed (for print and other jobs) may become slower. If you wish to give priority to job processing speed, select "Printing".

# SYSTEM SETTINGS FOR FAX

This section explains system settings that are specifically for the fax function.

The system settings for the fax function can only be configured when the facsimile expansion kit is installed.

## System Settings for Fax (General) List

When the system settings for fax are accessed with general rights, the following items appear. For items that can only be accessed with administrator rights, see "[System Settings for Fax \(Administrator\) List](#)" (page 7-110).



Depending on the machine specifications and peripheral devices installed, it may not be possible to use some settings.

### Address Control

Item	Factory default setting	Page
■ <a href="#">Address Control</a>		<a href="#">7-105</a>
● <a href="#">Address Book</a>	–	<a href="#">7-105</a>
● <a href="#">F-Code Memory Box</a>	–	<a href="#">7-107</a>

### Fax Data Receive/Forward

Item	Factory default setting	Page
■ <a href="#">Fax Data Receive/Forward</a>		<a href="#">7-109</a>
● <a href="#">Fax Settings</a>		<a href="#">7-109</a>
▶ <a href="#">Receive Setting</a>	Auto Reception	
▶ <a href="#">Multiple Set Print</a>	Disabled	
▶ <a href="#">Staple*</a>	Disabled	
▶ <a href="#">Forward Received Data</a>	–	

\* When a finisher is installed.

# Address Control

## Address Book

This section explains items specifically used for fax in "Address Control". For items that are also used for other functions, see "[Address Control](#)" (page 7-16).

When the [Address Book] key is touched, the following screen appears.

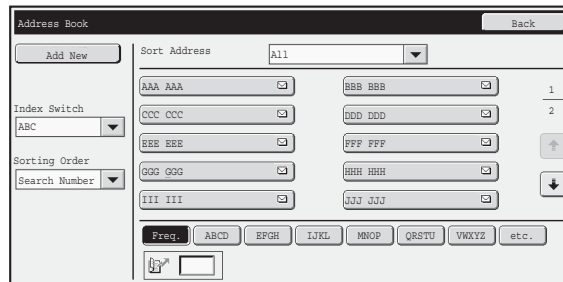

- **[Add New] key**

Use this to add a new address.

- **List display**

This displays a list of the currently stored addresses. An address can be selected to open an edit/delete screen for the address.

## Storing addresses

Touch the [Add New] key in the above screen to open a registration screen. Up to 1000 addresses can be stored. For information on the settings, see "[Settings](#)" (page 7-106).



When "[Disable Registering Destination from Operation Panel](#)" (page 7-82) is enabled in the system settings (administrator) for a function, addresses cannot be stored for that function.

## Editing and deleting addresses

An address can be selected from the list in the above screen to open an edit/delete screen for the address.

For information on the settings, see "[Settings](#)" (page 7-106).

Delete an address with the [Delete] key.



- **If you cannot edit or delete a one-touch individual or group key...**

Individual keys and group keys cannot be edited or deleted in the following situations:

- The key is used in a reserved transmission or a transmission in progress.
- The key is included in a group key.
- The key is included in a program.
- The key is specified as an end receiving machine in an F-code relay broadcast transmission.
- When "[Disable Registering Destination from Operation Panel](#)" (page 7-82) is enabled.

If the key is used in a reserved transmission or a transmission that is in progress, cancel the transmission or wait until it is completed and then edit or delete the key.

If the key is included in a group, first delete the key from the group and then edit or delete the key.

If the key is specified as a forwarding destination, cancel the forwarding destination setting and then edit or delete the key.

If "Disable Registering Destination from Operation Panel" has been enabled, clear this function and then edit or delete the key.

## Settings

Item	Description
<b>General items stored</b>	
Address Type	Select the type of address to be stored in the address book. In this case, select [Fax].
Search Number	Set a search number. The lowest available number is automatically entered. To change the number, enter a number from 0001 to 1000. A search number that has already been stored cannot be used.
Address Name	Enter a maximum of 36 characters for the address name.
Initial	Enter up to 10 characters for the initials. The initials you enter here determine the position of the one-touch key in the alphabetical index.
Key Name	Enter the name that you wish to appear in the address book (this is different from the address name).
Custom Index	Select the custom index in which the address will appear.
Register this Address to be added to the [Frequent Use] index.	Frequently used addresses can be stored in the [Frequent Use] index.
Fax Number	<p>Enter the fax number of the destination (maximum of 64 digits).</p> <p><b>To cancel the PBX settings* temporarily when sending a fax...</b> Touch the [R] key before entering a fax number. * This function is not available in some countries and regions.</p> <p><b>Entering a pause between digits of the number</b> Touch the [-] key at the place where you wish to enter a pause.</p> <p><b>To enter an F-code (sub-address and passcode)...</b></p> <ol style="list-style-type: none"> <li>(1) Enter the destination fax number.</li> <li>(2) Touch the [/] key.</li> <li>(3) Enter the sub address (maximum of 20 digits).</li> <li>(4) Touch the [/] key.</li> <li>(5) Enter the passcode (maximum of 20 digits). A passcode is not necessary if the destination machine does not use a passcode.</li> </ol> <p>The destination fax number can be a maximum of 64 digits including all numbers and characters. However, only the first 32 digits will appear in the display.</p>
Transmission Mode	<p>Set the transmission speed and the International Correspondence Mode. Selecting appropriate settings for these items may help eliminate communication errors.</p> <p><b>Transmission Speed</b> 33.6 kbps, 14.4 kbps, 9.6 kbps or 4.8 kbps can be selected for the transmission speed. Higher numbers are higher transmission speeds. Set the transmission speed only when you know what speed is most suitable, such as when you are sending a fax to a foreign country and telephone line conditions are bad. If you do not know the line conditions, do not change this setting.</p> <p><b>Transmission Mode</b> No Sound, Mode1, Mode2, or Mode3 can be selected for the International Correspondence Mode. When sending a fax to a foreign country, telephone line conditions can sometimes distort the fax or interrupt the transmission. If errors frequently occur when sending a fax to a foreign country, try each of modes 1 to 3 and select the mode that enables the best transmission.</p>

## F-Code Memory Box

This section explains how to store memory boxes for various types of F-code communication. When the [F-Code Memory Box] key is touched, the following screen appears.

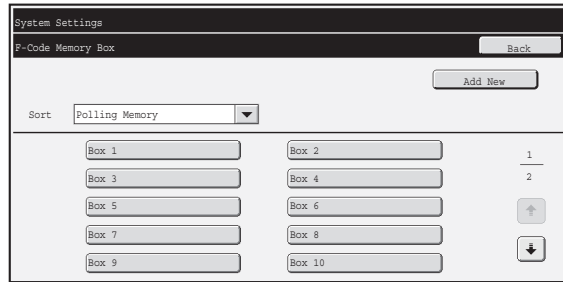

- **[Add New] key**

Use this to add a new memory box.

- **List display**

This displays a list of the currently stored memory boxes. A memory box can be selected to open an edit/delete screen for the memory box.

### Storing a memory box

Touch the [Add New] key in the above screen to open a registration screen. A total of 100 F-code memory boxes for all functions (polling memory, confidential, and relay broadcast) can be stored.

For information on the settings, see "[Settings](#)" (page 7-108).

### Editing and deleting a memory box

A memory box can be selected from the list in the above screen to open an edit/delete screen for the box.

For information on the settings, see "[Settings](#)" (page 7-108).

Delete a memory box with the [Delete] key.

## Settings

Item	Description
<b>Items common to all types</b>	
Box Type	<p>Select the type of box.</p> <ul style="list-style-type: none"> <li>• <b>Polling Memory:</b> Store a memory box for F-code polling memory. The sub-address and passcode that you program in the memory box are necessary for the other machine to poll your machine (request transmission) using F-code communication.</li> <li>• <b>Confidential:</b> Store a memory box for F-code confidential reception. In addition, store a "Print PIN" in the memory box to print faxes received by confidential reception. The sub-address and passcode that you program in the memory box are necessary for the other machine to send a fax to your machine by F-code confidential transmission.</li> <li>• <b>Relay Broadcast:</b> Store a memory box for F-code relay broadcast transmission. Store the fax numbers of the end recipients (up to 30) in the memory box. The sub-address and passcode that you program in the memory box are necessary for the other machine to perform an F-code relay request transmission (ask your machine to relay a fax).</li> </ul>
Memory Box Name	Enter a name (maximum of 18 characters) for the memory box.
Sub Address / Passcode	Enter a sub-address and passcode. A maximum of 20 digits can be entered for each. Separate a sub-address and passcode by a slash ("/").
<b>Items displayed when storing a confidential memory box</b>	
Print PIN	Set a "Print PIN" for confidential reception. Enter a 4-digit number.
<b>Items displayed when storing a relay broadcast memory box</b>	
Recipients	<p>Select the end recipients of the relay broadcast. Select the recipients from the address book.</p> <ul style="list-style-type: none"> <li>• <b>Direct Entry:</b> An address that is not stored in the address book can be directly entered. Enter the address in the same way as when storing an address for a mode.</li> <li>• <b>Address Review:</b> This displays a list of the selected recipients. Addresses can be deleted from this list if needed.</li> </ul>



- When programming a new memory box, a sub-address that is already programmed for another box cannot be used. However, the same passcode can be used for more than one memory box.
- A passcode can be omitted.
- [\*] and [#] cannot be used in a sub-address.
- Do not forget the Print PIN. In the event that you forget the Print PIN or need to verify the Print PIN, contact your dealer or nearest authorised service representative.



# Fax Data Receive/Forward

This section explains settings for reception and forwarding.

## Fax Settings

The following items appear when the "Fax Settings" are configured.

Item	Description
Receive Setting	Set the fax reception method. <ul style="list-style-type: none"> <li>• Auto Reception: When a call comes in, the machine rings and then automatically begins fax reception.</li> <li>• Manual Reception: This can be used when an existing extension phone is connected to the machine. Fax reception is begun by manual operation after answering on the extension phone.</li> </ul>
Multiple Set Print	Specify whether or not two or more copies of received faxes will be printed. The number of copies is set in " <a href="#">Fax Output Settings</a> ", (page 7-117).
Staple	Specify whether or not stapling is performed. (Only when a finisher is installed.) Stapling settings are set in " <a href="#">Fax Output Settings</a> ", (page 7-117).
Forward Received Data	When the machine cannot print because it is out of paper or out of toner, received faxes can be forwarded to another previously stored fax machine.



- If some pages of a fax that is being forwarded were successfully printed, only those pages that were not printed will be forwarded.
- A forwarded fax becomes a fax transmission job. If transmission does not take place because the transmission was cancelled or an error occurred, the fax will be held in memory until it can be printed.
- All faxes received are forwarded. Note, however, that faxes received to an F-code confidential memory box cannot be forwarded.
- To store a forwarding fax number, see "[Set the Telephone Number for Data Forwarding](#)" (page 7-116) in the system settings (administrator).
- Forwarding is not possible if no faxes were received or a forwarding fax number is not programmed.
- If "[Hold Setting for Received Data Print](#)" (page 7-82) is enabled, you will be prompted to enter a password. Enter the correct password with the numeric keys.

# System Settings for Fax (Administrator) List

When the system settings for fax are accessed with administrator rights, the following items appear. For information on the general settings, see "[System Settings for Fax \(General\) List](#)" (page 7-104).



- For the procedure for using the system settings (administrator), see "[Accessing the System Settings \(Administrator\)](#)" (page 7-28).
- Depending on the machine specifications and peripheral devices installed, it may not be possible to use some settings.

## Image Send Settings

Item	Factory default setting	Page
■ <a href="#">Image Send Settings</a>		<a href="#">7-112</a>
● <a href="#">Fax Settings</a>		<a href="#">7-112</a>
▶ <a href="#">Fax Default Settings</a>		<a href="#">7-112</a>
◆ <a href="#">Dial Mode Setting*</a>	Tone	<a href="#">7-112</a>
◆ <a href="#">Auto Wake Up Print</a>	Enabled	<a href="#">7-112</a>
◆ <a href="#">Pause Time Setting</a>	Varies depending on country and region	<a href="#">7-112</a>
◆ <a href="#">Fax Dest. Confirmation Mode</a>	Disabled	<a href="#">7-112</a>
◆ <a href="#">Speaker Settings</a>		<a href="#">7-112</a>
• Speaker	Volume: 5	
• Ringer Volume	Volume: 5	
• Line Monitor	Volume: No Sound	
• Fax Receive Complete Signal	Volume: 5; Tone Pattern: 3 Transmission Complete Sound Time Setting: 3 sec.	
• Fax Send Complete Signal	Volume: 5; Tone Pattern: 3 Transmission Complete Sound Time Setting: 3 sec.	
• Fax Communication Error Signal	Volume: 5; Tone Pattern: 3 Transmission Complete Sound Time Setting: 0.3 sec. each	
◆ <a href="#">Remote Reception Number Setting</a>	5	<a href="#">7-112</a>
◆ <a href="#">Original Print on Transaction Report</a>	Print Out Error Report Only	<a href="#">7-113</a>

Item	Factory default setting	Page
◆ Transaction Report Print Select Setting		7-113
• Single Sending	Print Out Error Report Only	
• Broadcasting	Print Out All Report	
• Receiving	No Printed Report	
• Confidential Reception	Print Out Notice Page	
◆ Activity Report Print Select Setting		7-113
• Auto Print at Memory Full	Disabled	
• Print Daily at Designated Time	Disabled	
◆ ECM	Enabled	7-113
◆ Distinctive Ring Detection*	Off	7-113
◆ PBX Setting*	Disabled	7-113
▶ Fax Send Settings		7-114
◆ Auto Reduction Sending Setting	Enabled	7-114
◆ Rotation Sending Setting	All Enabled	7-114
◆ Quick On Line Sending	Enabled	7-114
◆ Printing Page Number at Receiver	Enabled	7-114
◆ Date/Own Number Print Position Setting	Outside the Original Image	7-114
◆ Recall in Case of Line Busy	See "Country Differentiation Table" (page 7-115).	7-115
◆ Recall in Case of Communication Error	See "Country Differentiation Table" (page 7-115).	7-115
▶ Fax Receive Settings		7-116
◆ Number of Calls in Auto Reception	2	7-116
◆ Switching from Manual to Automatic Reception*	Disabled	7-116
◆ Duplex Reception Setting	Disabled	7-116
◆ Auto Receive Reduce Setting	Enabled	7-116
◆ Print Style Setting	Auto Size Select	7-116
◆ Set the Telephone Number for Data Forwarding	–	7-116
◆ Letter Size RX Reduce Print*	Disabled	7-117
◆ Receiving Date & Time Print	Off	7-117
◆ A3 RX Reduce*	Disabled	7-117
◆ Fax Output Settings	Varies depending on the machine configuration	7-117
▶ Allow/Reject Number Setting	All disabled	7-117
▶ Fax Polling Security	Enabled	7-118

\* This function is not available in some countries and regions.

# Image Send Settings

Settings related to the image send function (scan, Internet fax, etc.) can be configured. Touch the [Image Send Settings] key to configure the settings.

## Fax Settings

### Fax Default Settings

The fax settings can be enabled or disabled to suit the needs of your workplace.

### Dial Mode Setting

This setting can only be activated in Canada and Taiwan.

Select the appropriate setting for your telephone line type.

#### Dial Mode Setting

Select the line type from the list.

#### Auto Select

Select this after the line has been connected to have the machine automatically detect whether your line is a pulse dial line or a tone dial line.

### Auto Wake Up Print

When the [POWER] key (⏻) is "off" (but the main power switch is "on") and a fax is received, this function automatically activates the machine and prints the fax. When this function is disabled, received faxes are not printed until the [POWER] key (⏻) is switched "on".

### Pause Time Setting

Use this to change the length of pauses inserted in fax numbers.

If a hyphen "-" is entered when dialling or storing a fax number, a pause of 2 seconds is inserted.

The pause can be changed to any number of seconds from 1 to 15.

\* Note that in South Africa, the machine is normally set to 4 seconds.

### Fax Dest. Confirmation Mode

This setting specifies whether or not a destination verification message is displayed when sending a fax in order to prevent accidental transmission to the wrong destination.

### Speaker Settings

Use these settings to set the sound heard from the speaker for the Speaker, Ringer Volume, Line Monitor, Fax Receive Complete Signal, Fax Send Complete Signal, and Fax Communication Error Signal. For the Fax Receive Complete Signal, the Fax Send Complete Signal, and the Fax Communication Error Signal, the Tone Pattern and Transmission Complete Sound Time Setting can be selected in addition to the volume.

#### Check on Setup Sounds

Use this to check the selected tone pattern and volume.

### Remote Reception Number Setting

Fax reception can be activated from an extension phone connected to the machine by entering a 1-digit number and pressing the (\*) key twice on the phone's keypad. This number is called the remote reception number, and you can set it to any number from "0" to "9".

## Original Print on Transaction Report

When a transaction report is printed for a memory transmission, this is used to print part of the first page of the transmitted original on the transaction report. Select one of the settings below.

- Print Out All Report
- Print Out Error Report Only
- No Printed Report

This setting will not be effective if "[Transaction Report Print Select Setting](#)" below is set to "No Printed Report".

## Transaction Report Print Select Setting

This is used to select whether or not a transaction report will be printed, and if printed, the condition for being printed. Select a setting for each of the following operations:

### Single Sending

- Print Out All Report
- Print Out Error Report Only
- No Printed Report

### Broadcasting

- Print Out All Report
- Print Out Error Report Only
- No Printed Report

### Receiving

- Print Out All Report
- Print Out Error Report Only
- No Printed Report

### Confidential Reception

- Print Out Notice Page
- No Printed Report

When a transaction report is printed, you can have part of the first page of the transmitted original printed on the transaction report. For more information, see "[Original Print on Transaction Report](#)".



When transaction report printing is set for "Receiving", a report will not be printed for a reception from a number specified as a reject number in "[Allow/Reject Number Setting](#)" (page 7-117).

## Activity Report Print Select Setting

This is used to have the Image Sending Activity Report that is stored in the machine's memory printed at regular intervals.

The Image Sending Activity Report can be set to automatically print each time the number of transactions reaches 201, and it can also be set to automatically print at a specified time (once a day only). (The settings can be simultaneously enabled.)



- If you only select the "Print Daily at Designated Time" setting  and the number of recorded transactions exceeds 201 before the specified time, each new transaction will delete the oldest transaction (the oldest transaction will not be printed).
- The Image Sending Activity Report can also be printed manually. See "[List Print \(Administrator\)](#)" (page 7-94).

## ECM

Line conditions can sometimes distort a transmitted fax image. When ECM (Error Correction Mode) is turned on, pages that are distorted are automatically re-transmitted.



If the other machine supports Super G3, ECM will function regardless of this setting.

## Distinctive Ring Detection

This Setting can only be activated in Canada, Australia, New Zealand, and Hong Kong.

If multiple telephone numbers have been assigned to your telephone line, the number called can be identified by its ringing pattern. By using one number for voice calls and another number for faxes, you can tell which type of call you are receiving by the ringing pattern. You can set your machine to automatically receive faxes when your fax number is called by setting the pattern that corresponds to your fax number. (Note that in Canada, six selections are available.)

## PBX Setting

This Setting can only be activated in France and Germany.

When the machine is used on a PBX, you can enable the PBX setting to have the machine automatically connect to the outside line. When this setting is enabled, the [R] key appears in the base screen. When the [R] key is touched, the PBX setting is temporarily cancelled. If your PBX uses the Flash method to connect to the outside line, select the [Flash]. If your PBX uses an ID number to connect to the outside line, specify the ID number.



Select a number for the first digit and then a number or a hyphen "-" for the second and third digits.

## Fax Send Settings

Settings for fax transmission can be configured.

### Auto Reduction Sending Setting

This setting is used to have the size of transmitted faxes automatically reduced to match the size of the paper in the receiving machine.

If the setting is disabled, faxes are sent at full size.

Because the size is not adjusted to match the size of the printing paper, part of the received fax may be cut off.

### Rotation Sending Setting

When transmitting an image that is one of the following sizes, this function rotates the image counterclockwise 90 degrees. (The setting can be configured separately for each size.)

A4, B5R, A5R, 8-1/2" x 11", 5-1/2" x 8-1/2"R, 16K



A4R and 8-1/2" x 11"R originals are not rotated.

### Quick On Line Sending

When this setting is enabled, the machine starts transmitting a fax as soon as the first page is scanned. Transmission takes place at the same time as the remaining pages are being scanned.

If you disable this setting, transmission will not begin until all pages have been scanned. Note that this setting does not apply to manual transmission.

### Printing Page Number at Receiver

This setting is used to add the page number to the top of each fax page printed by the receiving machine.

### Date/Own Number Print Position Setting

This setting determines the position of the date and sender information printed at the top of faxes by the receiving machine. To have the information printed outside the transmitted document image, touch the [Outside the Original Image] key. To have the information printed inside the document image, touch [Inside the Original Image] key. For more information on the print position, see "[ADDING YOUR SENDER INFORMATION TO FAXES \(Own number sending\)](#)" (page 4-100) in "4. FACSIMILE".

## Recall in Case of Line Busy

This program is used to set the number of recall attempts and the interval between recall attempts when a transmission is not successful due to the line being busy or other reason.

### Number of Times to Recall When Line is Busy

This setting specifies whether or not recalling is performed when the line is busy. When recalling is performed, you can set the number of recall attempts.

### Interval to Wait Between Recall Attempts (min.) When Line is Busy

The interval between recall attempts can be set.

The number of recall attempts and the interval between attempts that can be set in each country are shown in the following table.

**Country Differentiation Table**

	The number of recall attempts	The interval between attempts
United Kingdom, France, Germany, Sweden, Italy, Spain, Netherlands, Saudi Arabia, South Africa, Hungary, Czech Republic, Slovakia, Poland, Greece, Russia	1 to 10 (default: 2)	any number of minutes from 1 to 15 (default: 3)
Canada	1 to 14 (default: 2)	
Australia, New Zealand, Singapore, Thailand, Malaysia, India, Philippines	1 to 9 (default: 2)	
Hong Kong	1 to 3 (default: 2)	
Taiwan	1 to 15 (default: 2)	any number of minutes from 4 to 15 (default: 4)
Indonesia	1 to 5 (default: 2)	



When this setting is enabled, note that your machine will not re-attempt a call when manual transmission or direct transmission is used.

## Recall in Case of Communication Error

This determines how many times your machine will automatically re-attempt the call if a fax transmission fails due to a communication error.

### Number of Times to Recall in Case of Error

Specify how many times the machine will re-attempt the call when a communication error occurs.

### Interval to Wait Between Recall Attempts (min.) in Case of Error

The interval between recall attempts can be set.

The number of recall attempts and the interval between attempts that can be set in each country are shown in the following table.

**Country Differentiation Table**

	The number of recall attempts	The interval between attempts
United Kingdom, France, Germany, Sweden, Italy, Spain, Netherlands, Saudi Arabia, South Africa, Hungary, Czech Republic, Slovakia, Poland, Greece, Russia	1 to 5 (default: 1)	any number of minutes from 1 to 15 (default: 1)
Australia, New Zealand, Canada	1 attempt	any number of minutes from 1 to 15 (default: 3)
Singapore, Thailand, Malaysia, India, Philippines	1 to 9 (default: 2)	any number of minutes from 1 to 15 (default: 1)
Hong Kong	1 to 3 (default: 2)	
Taiwan	1 to 15 (default: 2)	
Indonesia	1 to 5 (default: 2)	any number of minutes from 4 to 15 (default: 4)



When this setting is enabled, note that your machine will not re-attempt a call when manual transmission or direct transmission is used.

## Fax Receive Settings

Settings for fax reception can be configured.

### Number of Calls in Auto Reception

This setting is used to select the number of rings on which the machine automatically receives a call and begins fax reception in auto reception mode.

The "Number of Calls in Auto Reception" that can be set in each country are shown in the following table.

#### Country Differentiation Table

	The number of rings
United Kingdom, France, Germany, Sweden, Italy, Spain, Netherlands, Thailand, Hong Kong, Saudi Arabia, South Africa, Hungary, Czech Republic, Slovakia, Poland, Greece, Russia, Philippines, Indonesia	0 to 9
Australia, New Zealand	2 to 4
Singapore	0 to 3
Malaysia, India, Canada, Taiwan	0 to 15



If you select "0" for the number of rings, the machine will immediately answer and begin fax reception without ringing in auto reception mode.

### Switching from Manual to Automatic Reception

This setting can only be activated in France. When a fax is received in manual reception mode, you have the machine automatically switch to auto reception. The number of rings on which switching to auto reception takes place can be set to any number from 1 to 9.

### Duplex Reception Setting

This is used to have received faxes printed on both sides of the paper.

When this setting is enabled and a fax consisting of 2 or more pages is received (the pages must be the same size), the pages are printed on both sides of the paper.

### Auto Receive Reduce Setting

When a fax is received that includes the sender's name and number, the received image is slightly larger than the standard size. This setting is used to automatically reduce the image to fit the standard size.



- If Auto Receive Reduce is disabled, the edges of the image outside the standard size will be cut off. However, the image will be clearer because it will be printed at the same size as the original.
- Standard sizes are sizes such as A4 and B5 (8-1/2" x 11" and 8-1/2" x 5-1/2").

### Print Style Setting

This setting determines the paper selection condition when printing received faxes. Select one of the three conditions below.

#### Print Actual Size Cut off Disabled

The received fax image is printed at full size without dividing it onto multiple sheets of paper. If the same size of paper or larger paper is not loaded, the fax will be received in memory and will not be printed until a suitable size of paper is loaded.

However, if the received fax is longer than A3 (11" x 17") size, it will be automatically divided onto multiple sheets of paper.

#### Print Actual Size Cut off Enabled

Each received image is printed at full size. If necessary, the image is divided onto multiple sheets of paper.

#### Auto Size Select

Each received image is printed at full size when possible. When not possible, the image is automatically reduced before printing.

### Set the Telephone Number for Data Forwarding

When a problem prevents the machine from printing a received fax, the received fax can be forwarded to another fax machine. This setting is used to program the fax number of the destination fax machine. Only one forwarding fax number can be programmed (maximum of 64 digits).

To insert a pause between digits of the number, touch the [-] key.

If you wish to specify an F-code confidential memory box in the destination machine, touch the [/] key after entering the fax number and enter the F-code (sub-address and passcode).



## Letter Size RX Reduce Print

This program is not available in Canada and Philippines. When a letter-R (8-1/2" x 11"R) size fax is received, this setting reduces the fax to A4R size.



When this setting is enabled, A4R size faxes are also reduced.

## Receiving Date & Time Print

Enable this setting to have the date and time of reception printed.

Select [Inside the Received Image] or [Outside the Received Image] for the position where the date and time is printed.

When [Inside the Received Image] is selected, the date and time of reception is printed on the received image.

When [Outside the Received Image] is selected, the received image is reduced and the date and time of reception is printed in the blank area that results.



[Outside the Received Image] cannot be selected for the reception date and time print setting when "Auto Receive Reduce Setting" (page 7-116) is not enabled.

## A3 RX Reduce

This program can only be activated in Canada and Philippines.

When an A3 size fax is received, this function reduces the fax to ledger (11" x 17") size.



When this setting is enabled, ledger (11" x 17") size faxes are also reduced.

## Fax Output Settings

These settings are used to select the number of copies and output tray for received faxes. When a finisher is installed, the finisher tray can be selected as the output tray and stapling can be selected.

### Output tray

Select the output tray for received faxes.

### Number of Prints

Set the number of copies of received faxes that are printed to any number from 1 to 99.

### Staple Position

When a finisher is installed, set the position at which received faxes are stapled.

## Paper Size

When a finisher is installed, select the paper used for printing of received faxes.



- This setting can only be used when the [Multiple Set Print] and [Staple] checkboxes are selected  in "Fax Settings" (page 7-109).
- The maximum number of sheets that can be stapled is 50. (When the paper is oriented horizontally, the maximum number of sheets that can be stapled is 30.)

## Allow/Reject Number Setting

Use this setting to specify whether reception from a stored number is to be allowed or rejected.

Item	Description
Reject Reception	Reject reception from the stored number.
Allow Reception	Allow reception from the stored number.
All Invalid	Even if numbers have been stored, disregard the numbers and allow reception from all numbers.
Add New	Store a new number for which allow or reject will be specified (maximum of 50 numbers). Enter the number (maximum of 20 digits) and touch the [Store] key.
Registration Number List	A list of the stored numbers can be displayed. A number can be selected in this screen to delete it from the list.
Reject hidden Number	When this setting is enabled, reception from a number whose settings are not notified is rejected irrespective of the contents of the specific number reception settings.

### Reject hidden Number

Reception from a number whose settings are not notified can be rejected irrespective of the contents of the specific number reception settings.



When no numbers have been stored for allow/reject specification, no keys other than [Add New] can be selected.

## Fax Polling Security

The following settings are for regular polling memory using the Public Box.

### Set Fax Polling Security

When the memory polling function is used, this setting determines whether any machine will be allowed to poll your machine, or only machines that have been stored in your machine.

### Add New

When the Polling Security Setting is enabled, use this setting to store (or delete) the fax numbers of the machines that are allowed to poll your machine. The stored fax numbers are called passcode numbers. Up to 10 passcode numbers can be stored (maximum of 20 digits each).

### Passcode Number Key List

This shows a list of the stored passcode numbers. A number can be selected to delete it.



Note that these settings do not apply to F-code polling memory.

# SYSTEM SETTINGS MENU

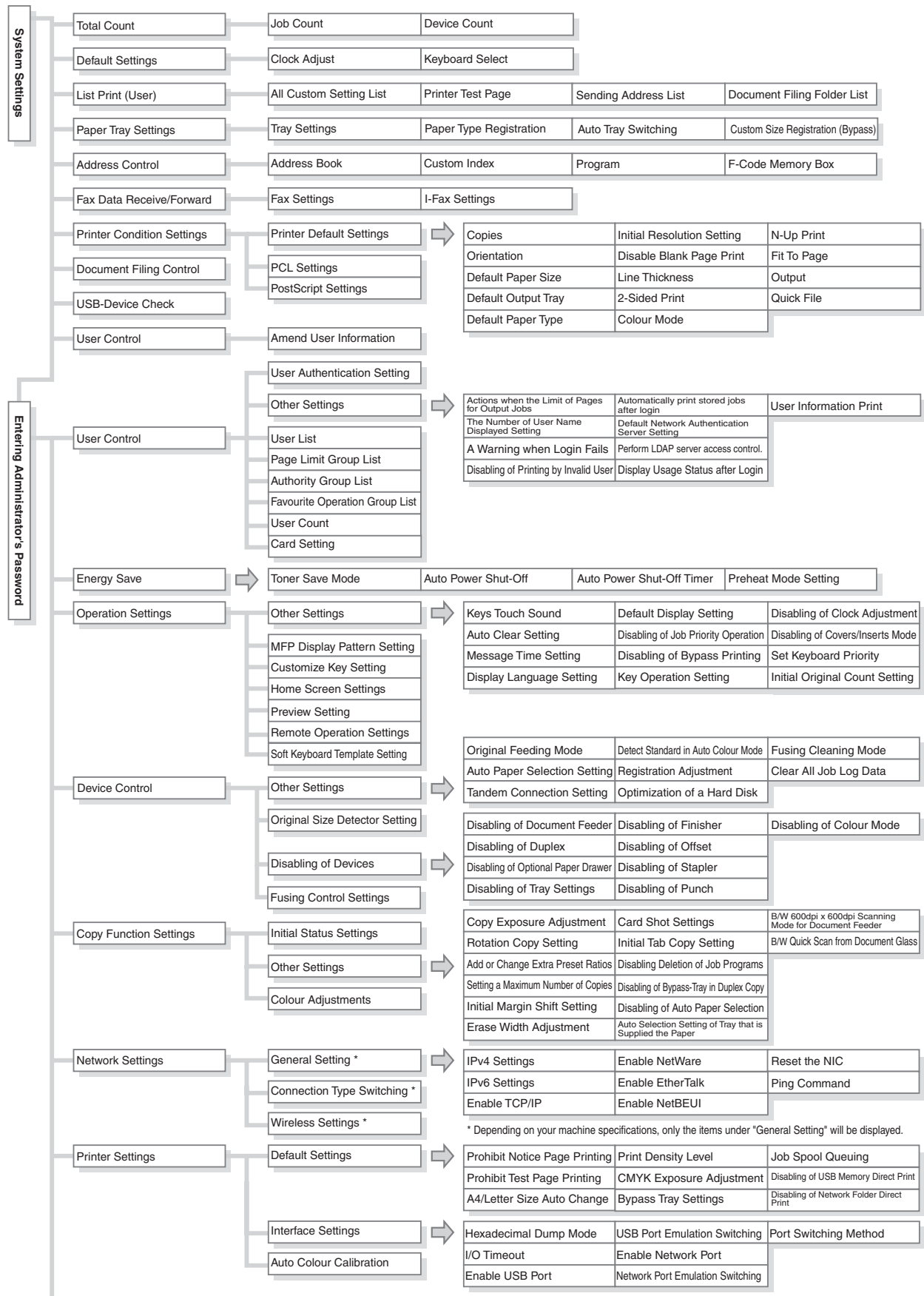

Image Send Settings																	
Operation Settings	Other Settings	<table border="1"> <tr> <td>Default Display Settings</td> <td>Must Input Next Address Key at Broadcast Setting</td> <td>Hold Setting for Received Data Print</td> </tr> <tr> <td>Address Book Default Selection</td> <td>Scan Complete Sound Setting</td> <td>Default Verification Stamp</td> </tr> <tr> <td>Image Orientation</td> <td>The Number of File Name/Subject/Body Keys Displayed Setting</td> <td>Erase Width Adjustment</td> </tr> <tr> <td>Initial Resolution Setting</td> <td>The Number of Direct Address Keys Displayed Setting</td> <td></td> </tr> <tr> <td>Default Exposure Settings</td> <td>Disable Switching of Display Order</td> <td></td> </tr> </table>	Default Display Settings	Must Input Next Address Key at Broadcast Setting	Hold Setting for Received Data Print	Address Book Default Selection	Scan Complete Sound Setting	Default Verification Stamp	Image Orientation	The Number of File Name/Subject/Body Keys Displayed Setting	Erase Width Adjustment	Initial Resolution Setting	The Number of Direct Address Keys Displayed Setting		Default Exposure Settings	Disable Switching of Display Order	
Default Display Settings	Must Input Next Address Key at Broadcast Setting	Hold Setting for Received Data Print															
Address Book Default Selection	Scan Complete Sound Setting	Default Verification Stamp															
Image Orientation	The Number of File Name/Subject/Body Keys Displayed Setting	Erase Width Adjustment															
Initial Resolution Setting	The Number of Direct Address Keys Displayed Setting																
Default Exposure Settings	Disable Switching of Display Order																
	Settings to Disable Registration	<table border="1"> <tr> <td>Disable Registering Destination from Operation Panel</td> <td>Disable Registration of Program</td> <td>Disable Destination Registration Using Global Address Search</td> </tr> <tr> <td>Disable Registering Destination on Web Page</td> <td>Disable Registration of Memory Box</td> <td>Disable Registration Using Network Scanner Tool</td> </tr> </table>	Disable Registering Destination from Operation Panel	Disable Registration of Program	Disable Destination Registration Using Global Address Search	Disable Registering Destination on Web Page	Disable Registration of Memory Box	Disable Registration Using Network Scanner Tool									
Disable Registering Destination from Operation Panel	Disable Registration of Program	Disable Destination Registration Using Global Address Search															
Disable Registering Destination on Web Page	Disable Registration of Memory Box	Disable Registration Using Network Scanner Tool															
	Settings to Disable Transmission	<table border="1"> <tr> <td>Disable [Resend] on Image Send Mode</td> <td>Disable Direct Entry</td> <td>Disable PC-Fax Transmission</td> </tr> <tr> <td>Disable Selection from Address Book</td> <td>Disable PC-I-Fax Transmission</td> <td></td> </tr> </table>	Disable [Resend] on Image Send Mode	Disable Direct Entry	Disable PC-Fax Transmission	Disable Selection from Address Book	Disable PC-I-Fax Transmission										
Disable [Resend] on Image Send Mode	Disable Direct Entry	Disable PC-Fax Transmission															
Disable Selection from Address Book	Disable PC-I-Fax Transmission																
	Own Name and Destination Set																
Scan Settings	Other Settings	<table border="1"> <tr> <td>Default Sender Set</td> <td>Compression Mode at Broadcasting</td> <td>Bcc Setting</td> </tr> <tr> <td>Default Colour Mode Settings</td> <td>Maximum Size of E-mail Attachments (E-mail)</td> <td>Disable Scan Function</td> </tr> <tr> <td>Initial File Format Setting</td> <td>Maximum Size of Data Attachments (FTP/Desktop/Network Folder)</td> <td>Pre-Setting Mail Signature</td> </tr> </table>	Default Sender Set	Compression Mode at Broadcasting	Bcc Setting	Default Colour Mode Settings	Maximum Size of E-mail Attachments (E-mail)	Disable Scan Function	Initial File Format Setting	Maximum Size of Data Attachments (FTP/Desktop/Network Folder)	Pre-Setting Mail Signature						
Default Sender Set	Compression Mode at Broadcasting	Bcc Setting															
Default Colour Mode Settings	Maximum Size of E-mail Attachments (E-mail)	Disable Scan Function															
Initial File Format Setting	Maximum Size of Data Attachments (FTP/Desktop/Network Folder)	Pre-Setting Mail Signature															
	Default Address Setting																
I-Fax Settings	I-Fax Default Settings	<table border="1"> <tr> <td>Auto Wake Up Print</td> <td>Original Print on Transaction Report</td> <td>Body Text Print Select Setting</td> </tr> <tr> <td>Compression Setting</td> <td>Transaction Report Print Select Setting</td> <td>Pre-Setting Mail Signature</td> </tr> <tr> <td>Speaker Volume Setting</td> <td>Activity Report Print Select Setting</td> <td></td> </tr> </table>	Auto Wake Up Print	Original Print on Transaction Report	Body Text Print Select Setting	Compression Setting	Transaction Report Print Select Setting	Pre-Setting Mail Signature	Speaker Volume Setting	Activity Report Print Select Setting							
Auto Wake Up Print	Original Print on Transaction Report	Body Text Print Select Setting															
Compression Setting	Transaction Report Print Select Setting	Pre-Setting Mail Signature															
Speaker Volume Setting	Activity Report Print Select Setting																
	I-Fax Send Settings	<table border="1"> <tr> <td>I-Fax Reception Report On/Off Setting</td> <td>Maximum Size of E-mail Attachments</td> <td>Recall in Case of Line Busy</td> </tr> <tr> <td>I-Fax Reception Report Request Timeout Setting</td> <td>Rotation Sending Setting</td> <td>Recall in Case of Communication Error</td> </tr> <tr> <td>Number of Resend Times at Reception Error</td> <td>Printing Page Number at Receiver</td> <td></td> </tr> </table>	I-Fax Reception Report On/Off Setting	Maximum Size of E-mail Attachments	Recall in Case of Line Busy	I-Fax Reception Report Request Timeout Setting	Rotation Sending Setting	Recall in Case of Communication Error	Number of Resend Times at Reception Error	Printing Page Number at Receiver							
I-Fax Reception Report On/Off Setting	Maximum Size of E-mail Attachments	Recall in Case of Line Busy															
I-Fax Reception Report Request Timeout Setting	Rotation Sending Setting	Recall in Case of Communication Error															
Number of Resend Times at Reception Error	Printing Page Number at Receiver																
	I-Fax Receive Settings	<table border="1"> <tr> <td>Auto Receive Reduce Setting</td> <td>Letter Size RX Reduce Print</td> <td>POP3 Communication Timeout Setting</td> </tr> <tr> <td>Duplex Reception Setting</td> <td>Receiving Date &amp; Time Print</td> <td>Reception Check Interval Setting</td> </tr> <tr> <td>Set Address for Data Forwarding</td> <td>A3 RX Reduce</td> <td>I-Fax Output Setting</td> </tr> </table>	Auto Receive Reduce Setting	Letter Size RX Reduce Print	POP3 Communication Timeout Setting	Duplex Reception Setting	Receiving Date & Time Print	Reception Check Interval Setting	Set Address for Data Forwarding	A3 RX Reduce	I-Fax Output Setting						
Auto Receive Reduce Setting	Letter Size RX Reduce Print	POP3 Communication Timeout Setting															
Duplex Reception Setting	Receiving Date & Time Print	Reception Check Interval Setting															
Set Address for Data Forwarding	A3 RX Reduce	I-Fax Output Setting															
	Allow/Reject Mail or Domain Name Setting																
Fax Settings	Fax Default Settings	<table border="1"> <tr> <td>Dial Mode Setting</td> <td>Remote Reception Number Setting</td> <td>Distinctive Ring Detection</td> </tr> <tr> <td>Auto Wake Up Print</td> <td>Original Print on Transaction Report</td> <td></td> </tr> <tr> <td>Pause Time Setting</td> <td>Transaction Report Print Select Setting</td> <td></td> </tr> <tr> <td>Fax Dest. Confirmation Mode</td> <td>Activity Report Print Select Setting</td> <td></td> </tr> <tr> <td>Speaker Settings</td> <td>ECM</td> <td></td> </tr> </table>	Dial Mode Setting	Remote Reception Number Setting	Distinctive Ring Detection	Auto Wake Up Print	Original Print on Transaction Report		Pause Time Setting	Transaction Report Print Select Setting		Fax Dest. Confirmation Mode	Activity Report Print Select Setting		Speaker Settings	ECM	
Dial Mode Setting	Remote Reception Number Setting	Distinctive Ring Detection															
Auto Wake Up Print	Original Print on Transaction Report																
Pause Time Setting	Transaction Report Print Select Setting																
Fax Dest. Confirmation Mode	Activity Report Print Select Setting																
Speaker Settings	ECM																
	Fax Send Settings	<table border="1"> <tr> <td>Auto Reduction Sending Setting</td> <td>Printing Page Number at Receiver</td> <td>Recall in Case of Communication Error</td> </tr> <tr> <td>Rotation Sending Setting</td> <td>Date/Own Number Print Position Setting</td> <td></td> </tr> <tr> <td>Quick On Line Sending</td> <td>Recall in Case of Line Busy</td> <td></td> </tr> </table>	Auto Reduction Sending Setting	Printing Page Number at Receiver	Recall in Case of Communication Error	Rotation Sending Setting	Date/Own Number Print Position Setting		Quick On Line Sending	Recall in Case of Line Busy							
Auto Reduction Sending Setting	Printing Page Number at Receiver	Recall in Case of Communication Error															
Rotation Sending Setting	Date/Own Number Print Position Setting																
Quick On Line Sending	Recall in Case of Line Busy																
	Fax Receive Settings	<table border="1"> <tr> <td>Number of Calls in Auto Reception Switching from Manual to Automatic Reception</td> <td>Print Style Setting</td> <td>A3 RX Reduce</td> </tr> <tr> <td></td> <td>Set the Telephone Number for Data Forwarding</td> <td>Fax Output Settings</td> </tr> <tr> <td>Duplex Reception Setting</td> <td>Letter Size RX Reduce Print</td> <td></td> </tr> <tr> <td>Auto Receive Reduce Setting</td> <td>Receiving Date &amp; Time Print</td> <td></td> </tr> </table>	Number of Calls in Auto Reception Switching from Manual to Automatic Reception	Print Style Setting	A3 RX Reduce		Set the Telephone Number for Data Forwarding	Fax Output Settings	Duplex Reception Setting	Letter Size RX Reduce Print		Auto Receive Reduce Setting	Receiving Date & Time Print				
Number of Calls in Auto Reception Switching from Manual to Automatic Reception	Print Style Setting	A3 RX Reduce															
	Set the Telephone Number for Data Forwarding	Fax Output Settings															
Duplex Reception Setting	Letter Size RX Reduce Print																
Auto Receive Reduce Setting	Receiving Date & Time Print																
	Allow/Reject Number Setting																
	Fax Polling Security																
Document Filing Settings	Other Settings	<table border="1"> <tr> <td>Default Mode Settings</td> <td>Default Exposure Settings</td> <td>Disable Stamp for Reprinting</td> </tr> <tr> <td>Sort Method Setting</td> <td>Initial Resolution Settings</td> <td>Batch Print Settings</td> </tr> <tr> <td>Administrator Authority Setting</td> <td>Colour Data Compression Ratio Setting</td> <td>Erase Width Adjustment</td> </tr> <tr> <td>Delete All Quick Files</td> <td>Scan Complete Sound Setting</td> <td>Card Shot Settings</td> </tr> <tr> <td>Default Colour Mode Settings</td> <td>Default Output Tray</td> <td></td> </tr> </table>	Default Mode Settings	Default Exposure Settings	Disable Stamp for Reprinting	Sort Method Setting	Initial Resolution Settings	Batch Print Settings	Administrator Authority Setting	Colour Data Compression Ratio Setting	Erase Width Adjustment	Delete All Quick Files	Scan Complete Sound Setting	Card Shot Settings	Default Colour Mode Settings	Default Output Tray	
Default Mode Settings	Default Exposure Settings	Disable Stamp for Reprinting															
Sort Method Setting	Initial Resolution Settings	Batch Print Settings															
Administrator Authority Setting	Colour Data Compression Ratio Setting	Erase Width Adjustment															
Delete All Quick Files	Scan Complete Sound Setting	Card Shot Settings															
Default Colour Mode Settings	Default Output Tray																
	Document Output Options																
	Automatic Deletion of File Settings																
List Print (Administrator)	Administrator Settings List	<table border="1"> <tr> <td>Image Sending Activity Report</td> <td>Data Receive/Forward List</td> <td>Web Settings List</td> <td>Metadata Set List</td> </tr> </table>	Image Sending Activity Report	Data Receive/Forward List	Web Settings List	Metadata Set List											
Image Sending Activity Report	Data Receive/Forward List	Web Settings List	Metadata Set List														
Security Settings	SSL Settings	IPsec Settings	IEEE802.1X Setting	Data Clearance Settings													
Enable/Disable Settings	Release Lock on File/Folder Operation	Initialize Private Data/Data in Machine															
Change Administrator Password																	
Product Key																	
Data Backup	Storage Backup	Device Cloning															
Storing/Calling of System Settings	Restore Factory Defaults	Store Current Configuration	Restore Configuration														
Sharp OSA Settings	External Account Setting	USB Driver Settings	Job Priority Preference														

# CHAPTER 8

# TROUBLESHOOTING

This chapter provides solutions to possible problems in a question and answer format. Locate the question that relates to your problem and use the answer to help correct the situation. If you are unable to solve a problem using this manual, please contact your dealer or nearest authorised service representative.

## System settings

Descriptions of system settings similar to the following example appear in this manual.

Example:

→ System Settings (Administrator) > "Copy Function Settings" > "Other Settings" > "Rotation Copy Setting" >

This is an abbreviated description of the procedure for selecting the setting. ">" indicates the setting sequence and  indicates the state of the setting after it has been enabled. Use these descriptions as a quick manual to help you configure the settings.

## TROUBLESHOOTING PROBLEMS

### FREQUENTLY ASKED QUESTIONS

- Making a copy of a non-standard size original . . . 8-3
- I can't print from a computer... . . . . . 8-4
- Printing on an envelope . . . . . 8-5
- Changing the paper size used for a print job . . . . 8-6
- Adjusting the volume of the ringer . . . . . 8-7
- The machine starts printing when I try to forward data.... . . . . . 8-7
- Checking the machine's communication record. . . . 8-7

### REMOVING MISFEEDS

- REMOVING MISFEEDS. . . . . 8-8
- PAPER MISFEED ILLUSTRATIONS . . . . . 8-9

### REMOVING STAPLE JAMS

- FINISHER. . . . . 8-11

### COPYING

- PROBLEMS RELATED TO COPYING OPERATION . . . . . 8-13
- PROBLEMS RELATED TO COPY RESULTS . . . . . 8-15

### PRINTING

- PROBLEMS RELATED TO PRINTING OPERATION . . . . . 8-16
- PROBLEMS RELATED TO PRINT RESULTS . . . . . 8-19

## FACSIMILE

- PROBLEMS RELATED TO TRANSMISSION . . . 8-23
- PROBLEMS RELATED TO RECEPTION . . . . 8-25
- PROBLEMS RELATED TO TELEPHONE . . . . 8-26
- PROBLEMS RELATED TO AUDIBLE SIGNALS . . . . . 8-26
- PROBLEMS RELATED TO ONE-TOUCH INDIVIDUAL KEYS / GROUP KEYS . . . . . 8-27

## SCANNING / INTERNET FAX

- PROBLEMS RELATED TO SCANNING / INTERNET FAX OPERATION . . . . . 8-28
- PROBLEMS RELATED TO SCAN RESULTS . . . . . 8-30
- PROBLEMS RELATED TO ONE-TOUCH INDIVIDUAL KEYS / GROUP KEYS . . . . . 8-32

## DOCUMENT FILING

- PROBLEMS RELATED TO FILING . . . . . 8-34
- PROBLEMS RELATED TO FILE MANAGEMENT . . . . . 8-35

## GENERAL PROBLEMS

- PROBLEMS RELATED TO MACHINE OPERATION . . . . . 8-39
- PROBLEMS RELATED TO PAPER FEEDING AND OUTPUT . . . . . 8-41
- PROBLEMS RELATED TO QUALITY / PRINT RESULTS . . . . . 8-43
- PROBLEMS RELATED TO PERIPHERAL DEVICES . . . . . 8-45
- OTHER PROBLEMS . . . . . 8-47

# TROUBLESHOOTING PROBLEMS

The chart below shows the procedure to follow in the event a problem occurs. Use it as a troubleshooting guide.



## Check this chapter first

You may find a solution to your problem here.



## Ask the administrator for help

Inform the machine's administrator of the nature of the problem and ask for help.



## Refer to other instruction manuals

You can sometimes find the solution to your problem in other chapters in this manual or in the other instruction manuals included with the machine.

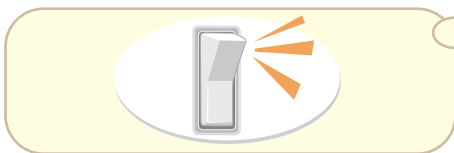

## Turn the power off and then on again

Turning the power off and on may solve the problem in some cases, so try doing so before attributing the problem to a malfunction.

Press the [POWER] key (⏻) to turn off the power and switch the main power switch to the "off" position. Wait at least 10 seconds and then switch the main power switch and the [POWER] key (⏻) back on in that order.

- When turning off the main power switch, ensure that each of the lamps on the operation panel has been turned off.



## Contact your dealer or nearest authorised service representative.

If, having tried the above steps, your problem remains unsolved, contact the dealer from whom you purchased the machine or your nearest authorised service representative.

# FREQUENTLY ASKED QUESTIONS

## Making a copy of a non-standard size original

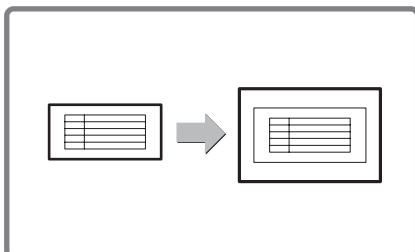

The procedure for making a copy of a payment slip or other non-standard size original is explained below.

The "Centring" special mode of copy mode can be selected to position the copied image in the centre of the paper.

### 1 Place the originals.

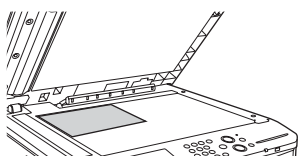

If the X dimension (width) of the document is less than 140 mm (5-1/2") or the Y dimension (height) is less than 131 mm (5-1/8"), place the original on the document glass. For a thin original, use "Slow Scan Mode".

### 2 Enter the original size.

From the base screen of copy mode, touch [Original] then [Size Input].

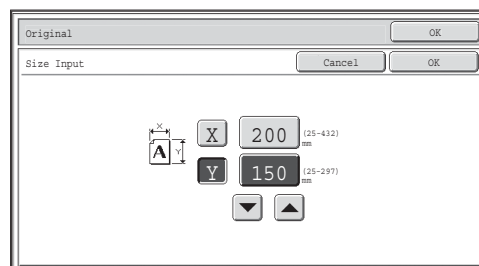

### 3 Place paper in the bypass tray.

The bypass tray is used here to copy onto paper that is not loaded in any of the paper trays of the machine.

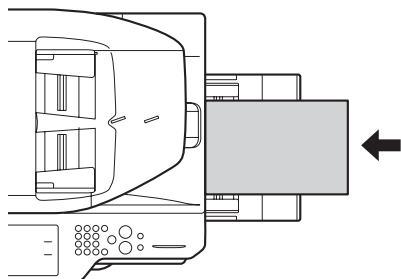

Type : Recycled  
Size : A4

### 4 Select the bypass tray.

From the base screen of copy mode, touch [Paper Select] and then "Bypass tray paper type".

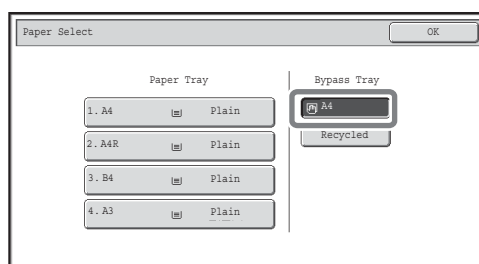
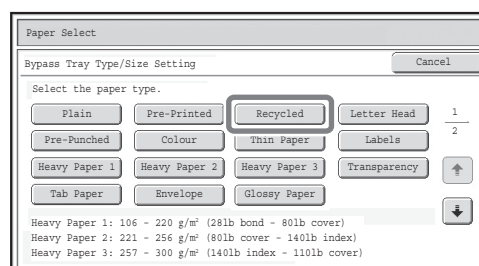

# I can't print from a computer...

First check that the printer driver for the machine is selected when printing. Also check that the printer driver port is set correctly.

## Checking the printer name

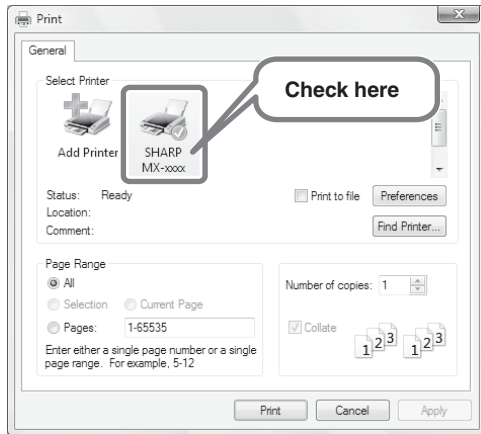

Check that the machine is selected in the Print dialog box, and select the machine if it is not.

If your machine is not listed, the printer driver is not installed. Install the printer driver and try again.

## Checking port settings in the printer driver

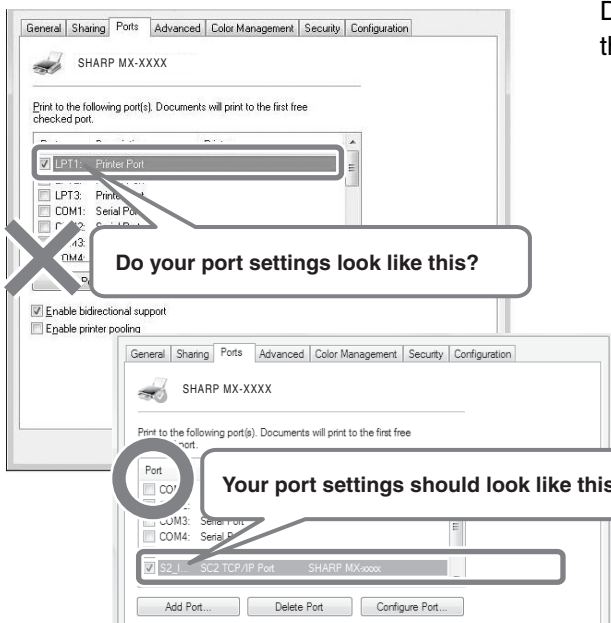

Display the printer driver's Properties dialog box and click the [Port] tab.



## Printing on an envelope

The procedure for printing on an envelope is explained below. Only the name and address side of an envelope can be printed on.

It is recommended that you do a test print to check the print result before using an envelope.

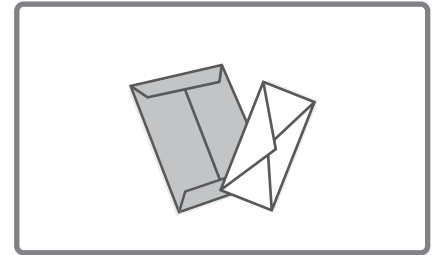

### 1 Place paper in the bypass tray.

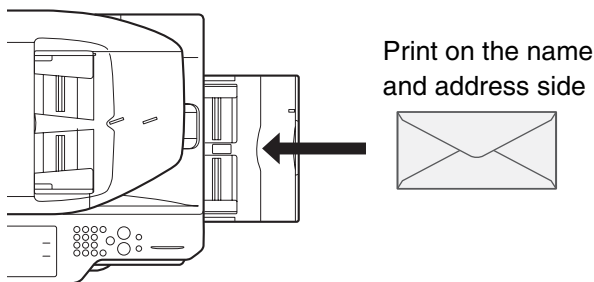

### 2 Tray Settings.

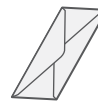
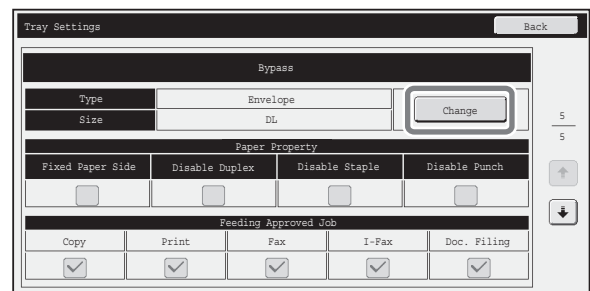

Type : Envelope  
Size : Select the envelope size

### 3 Select settings in the printer driver.

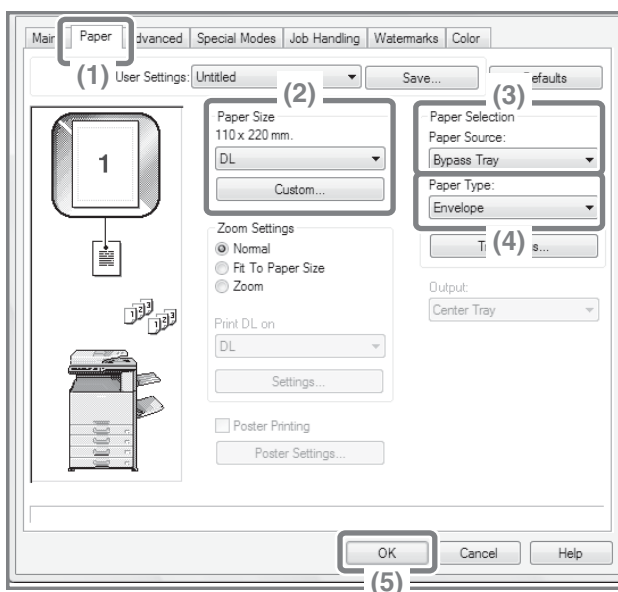

- (1) Click the [Paper] tab.
- (2) Select the size of the envelope in "Paper Size".
- (3) Select "Bypass Tray" from "Paper Source" in "Paper Selection".
- (4) Select [Envelope] in "Paper Type".  
If needed, select the "Rotate 180 degrees" checkbox (  ) in "Image Orientation" on the [Main] tab.
- (5) Click the [OK] button.

# Changing the paper size used for a print job

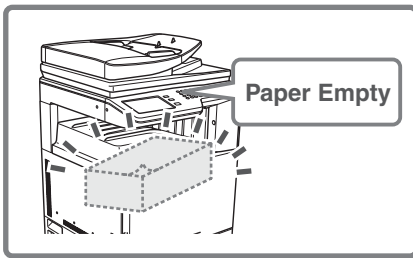

When the size of paper specified for a print job is not loaded in any of the machine's paper trays, follow the steps below to change the paper size.

## 1 Check details on the job.

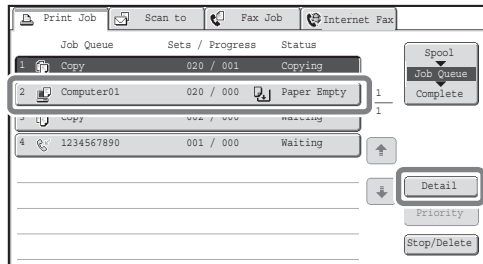

Touch the [JOB STATUS] key (•◀▶) on the touch panel to display the job status screen.

Select the job whose status is [Paper Empty] and touch the [Detail] key.

To delete the job, you can press the [Stop/Delete] key.

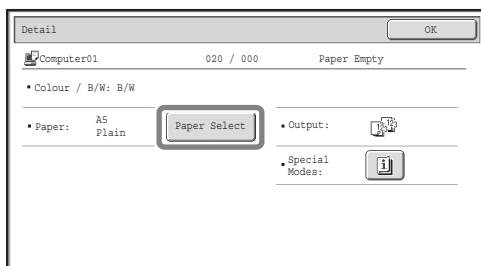

Check the paper size specified for the job in the detail screen, and touch the [Paper Select] key.

## 2 Change the paper size used for the job.

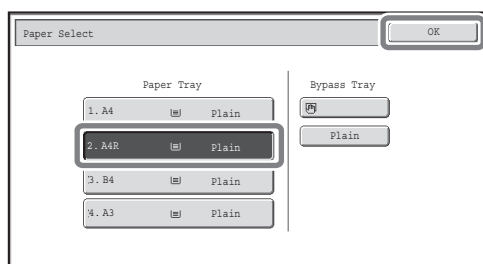

Select the paper size on which you wish to print the job from the set paper sizes.

To avoid cutting off part of the image, select a paper size that is larger than the paper size specified for the job.

## Adjusting the volume of the ringer

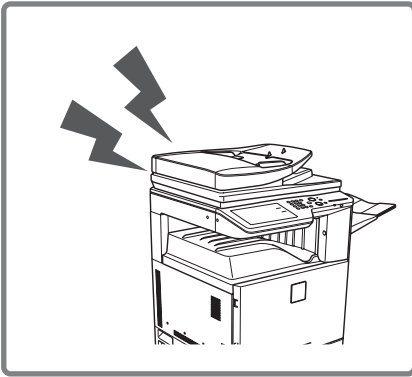

If the ringing sound made when the machine receives a fax is too loud or too soft, follow the steps below to adjust the volume.

The fax ringer volume is adjusted in the system settings (administrator).

Touch the [SYSTEM SETTINGS] key (◆) on the touch panel, touch [Image Send Settings] - [Fax Settings] - [Fax Default Settings] - [Speaker Settings] - [Ringer Volume] in that order, and then select the desired volume.

## The machine starts printing when I try to forward data...

Before forwarding received fax data to a shared folder, check that destination computer is turned on.

If the computer is not turned on, the machine prints the received fax data. If data is being forwarded to several computers, received data is printed if even one of the computers is turned off.

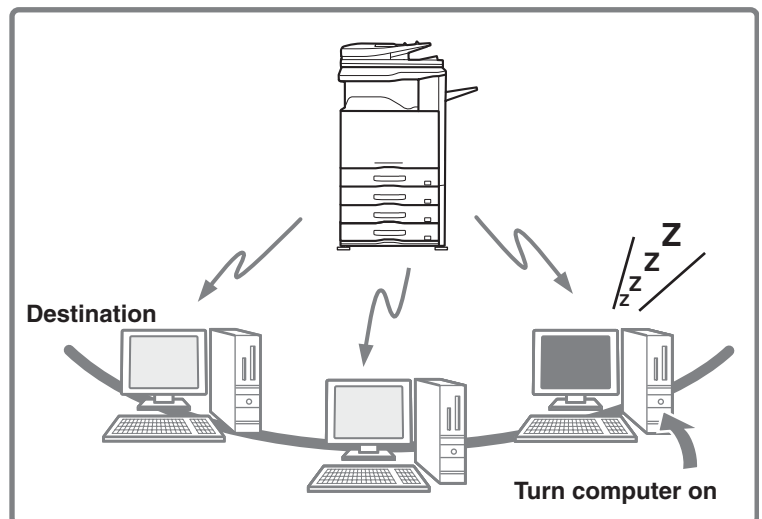

## Checking the machine's communication record

To check the machine's record of communication using the image send function, follow the steps below to print the image sending activity report.

The image sending activity report is printed from the system settings (administrator).

Touch the [SYSTEM SETTINGS] key (◆) on the touch panel, and then touch [List Print (Administrator)] - [Image Sending Activity Report] to print the report.

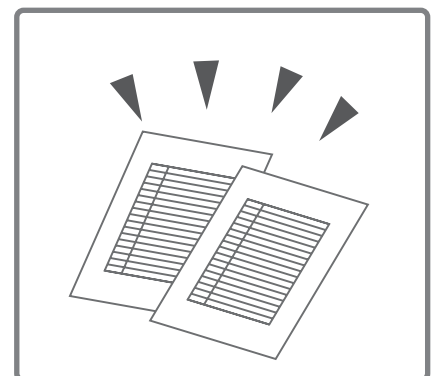

# REMOVING MISFEEDS

This section explains what to do when a paper misfeed occurs in the machine.



## Caution

The fusing unit is hot. Take care not to burn yourself when removing a misfeed.



- When removing misfed paper, do not touch or damage the transfer belt.
- Carefully pull the paper out without tearing it.
- A misfeed may have occurred inside the machine. Check carefully and remove the misfeed.
- If the paper tears, be sure to remove all pieces from the machine.



## REMOVING MISFEEDS

When a paper misfeed occurs, the message "A misfeed has occurred." will appear in the touch panel and printing and scanning will stop. In this event, touch the [Information] key in the touch panel. When the key is touched, instructions for removing the misfeed will appear. Follow the instructions. When the misfeed is cleared, the message will automatically clear.

The approximate locations of possible misfeeds are indicated by blinking ▼ marks as shown below.

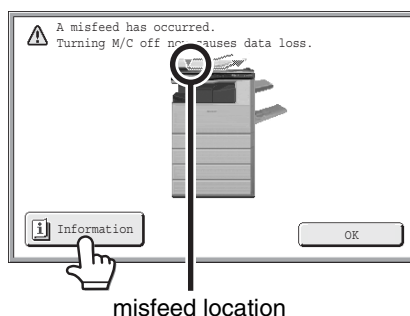

- While the message appears, printing and scanning cannot be resumed.
- If the message does not clear even after the misfeed has been removed, the causes below are possible. Check once again.
  - The misfeed was not correctly removed.
  - A torn piece of paper remains in the machine.
  - A cover or unit that was opened or moved to remove the misfeed was not returned to its original position.

# PAPER MISFEED ILLUSTRATIONS

If you require more information when reading the instructions in the touch panel, see the paper misfeed illustrations below. Refer to the illustration below and then go to the appropriate illustration (1 to 10) for your situation.

☞ (1)-(3): page 8-9, (4)-(10): page 8-10

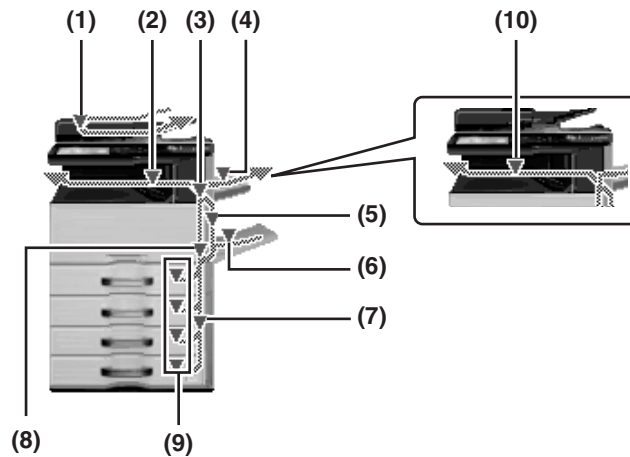

## (1) Original misfeed

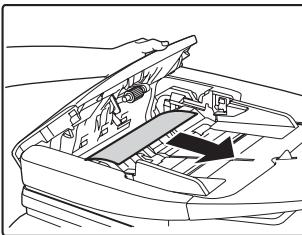

Open the document feeder cover and remove the misfed originals.

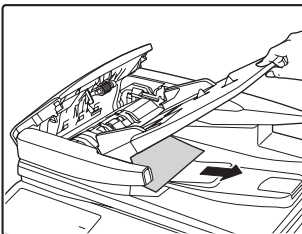

Pull out the document feeder tray and remove the misfed paper.

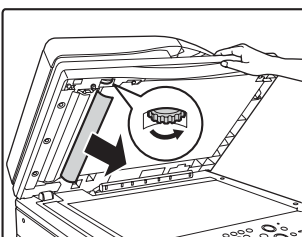

Open the automatic document feeder. Rotate the transfer roller in the direction of the arrow and remove the original.

## (2) Paper misfeed in the output area

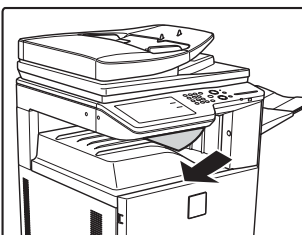

Remove the misfed paper.

## (3) Paper misfeed in the fusing unit

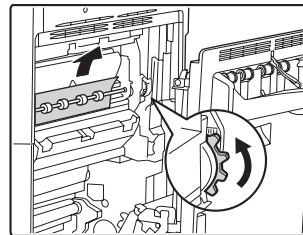

Rotate knob and remove the misfed paper.

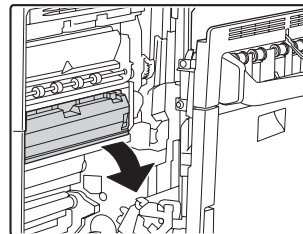

If the misfed paper is inside the fusing area, press down on the green part to tilt the fusing unit down toward you.

### ⚠ Caution

The fusing unit area is hot. Take care not to burn yourself. (Do not touch any metal parts.)



Unfused toner may remain on the paper that is removed. Take care that it does not soil your hands or clothing.

**(4) Paper misfeed in the exit tray unit (right tray)**

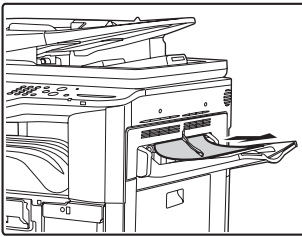

Remove the misfed paper.

**(5) Paper misfeed in the reversing unit**

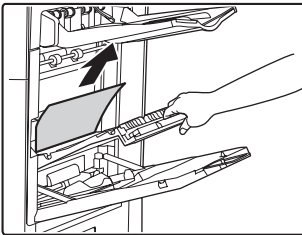

Open the Paper reversing section cover and remove the misfed paper.

**(6) Paper misfeed in the bypass tray**

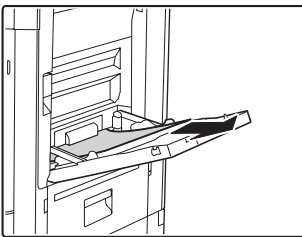

Remove the misfed paper.

**(7) Paper misfeed in tray 1 to tray 4 (side)**



The misfeed may have occurred inside the machine. Check carefully and remove it.

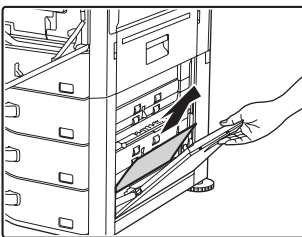

**(8) Paper misfeed in the transport area**

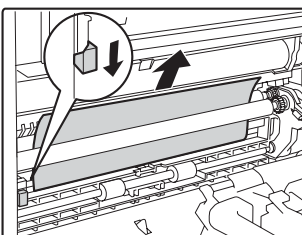

Lower the lever in the direction of the arrow to remove the misfed paper.

**(9) Paper misfeed in tray 1 to tray 4 (in the tray)**

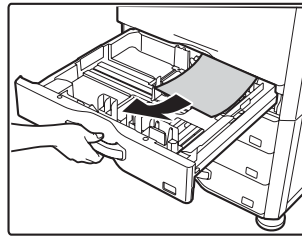

Before pulling the tray out, open the right cover and check if there is a paper misfeed. If you pull the tray out without checking, you may tear misfed paper and make it more difficult to remove the pieces that remain in the machine.

➤ [Paper misfeed in tray 1 to tray 4 \(side\)](#)

**(10) Paper misfeed in the finisher**

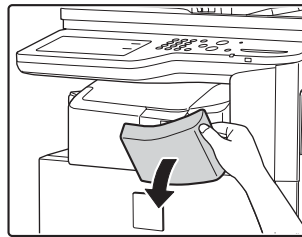

Open the front cover.

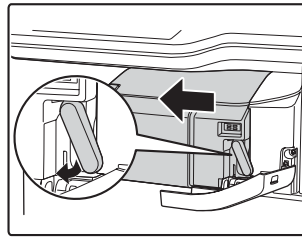

While pressing the lever over to the left, slide the finisher to the left until it stops.

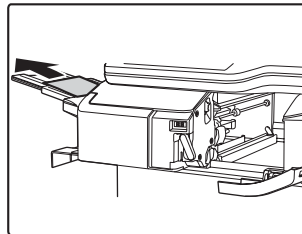

Turn roller rotating knob in the direction of the arrow to remove the misfed paper.

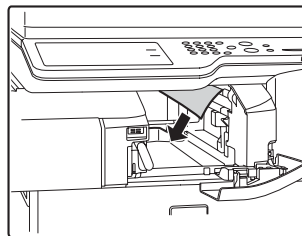
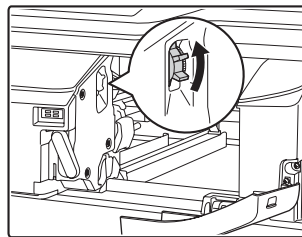

Make sure that there is no misfed paper in the machine.

# REMOVING STAPLE JAMS

Follow the steps below to remove a staple jam.

 FINISHER

## FINISHER

1

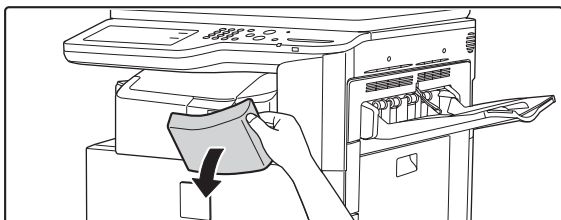

**Open the cover.**

2

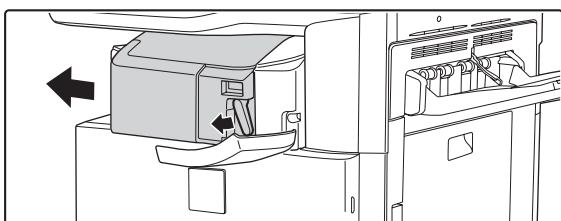

**While pressing the lever over to the left, slide the finisher to the left until it stops.**

Gently slide the finisher until it stops.

3

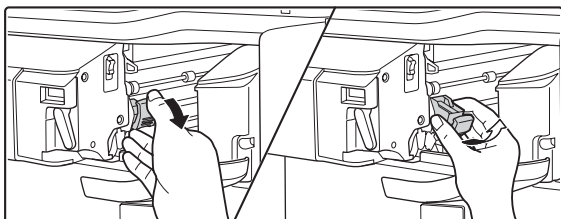

**Lower the staple case release lever and remove the staple case.**

Pull the staple case out to the right.

4

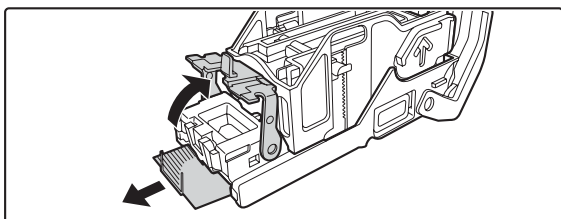

**Raise the lever at the front end of the staple case and remove the jammed staple.**

Remove the leading staple if it is bent. If bent staples remain, a staple jam will occur again.



Take care that a bent staple does not hurt you.

5

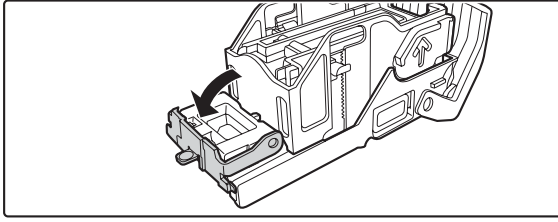

**Lower the lever at the front end of the staple case.**

6

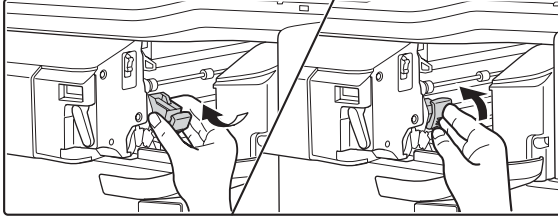

**Replace the staple case.**

Push the staple case in until it clicks into place.

7

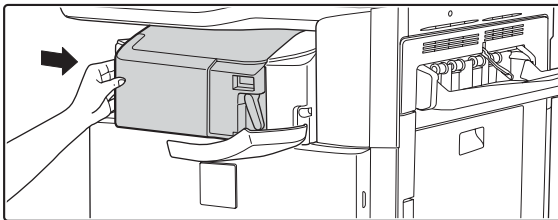

**Slide the finisher back to the right.**

Gently slide the finisher back to the right until it locks into its original position.

8

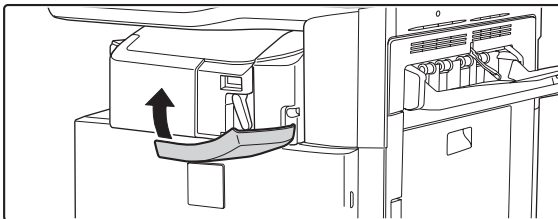

**Close the cover.**



# COPYING

## PROBLEMS RELATED TO COPYING OPERATION

- Copying does not take place. . . . . 8-13
- Auto selection of the colour mode does not take place. . . . . 8-13
- Image rotation does not take place. . . . . 8-14
- Two-sided copying does not take place. . . . . 8-14
- The paper size of a tray cannot be set. . . . . 8-14

## PROBLEMS RELATED TO COPY RESULTS

- The image is too light or too dark. . . . . 8-15
- Colours are off. . . . . 8-15
- Part of the image is cut off. . . . . 8-15
- Copies come out blank. . . . . 8-15

• If you cannot find the item that you are looking for in the above table of contents, see "[GENERAL PROBLEMS](#)" (page 8-37).

• If you are unable to solve a problem using the solutions in this manual, switch off the [POWER] key (⏻) and the main power switch. Wait at least 10 seconds, and then switch on the main power switch and the [POWER] key (⏻) in that order.

When the LINE indicator is lit or the DATA indicator is lit or blinking, do not switch off the main power switch or unplug the power plug. This may damage the hard drive or cause the data being stored or received to be lost.

## PROBLEMS RELATED TO COPYING OPERATION

Problem	Point to check	Solution
<b>Copying does not take place.</b>	Have functions been disabled by the administrator?	When user authentication is enabled, the functions that you can use may be restricted in your user settings. Check with your administrator.
<b>Auto selection of the colour mode does not take place.</b>	Are you using one of the following types of originals? <b>Black &amp; White is not selected</b> <ul style="list-style-type: none"> <li>• Are there colours or colouring in the paper?</li> </ul> <b>Colour is not selected</b> <ul style="list-style-type: none"> <li>• The colour in the original is very light.</li> <li>• The colour in the original is very dark, almost black.</li> <li>• Is only a very small area of the original coloured?</li> </ul>	When the colour mode is set to "Auto", the machine detects whether the original is black and white or colour when the [COLOUR START] key is pressed. However, when an original similar to one of those at left is used, automatic detection may not give the correct result. In this event, specify the colour mode manually.

Problem	Point to check	Solution
<b>Image rotation does not take place.</b>	Did you select the paper size or copy ratio manually?	Copy using automatic paper selection and automatic ratio selection.
	Are you copying using settings that do not allow rotate copying?	Rotate copying can generally be combined with other special modes, however, some combinations are not possible. If a prohibited combination is selected, a message will appear in the touch panel.
	Is "Rotation Copy Setting" disabled in the system settings (administrator)?	Check with your administrator. If you are the administrator, enable "Rotation Copy Setting". → System Settings (Administrator) > "Copy Function Settings" > "Other Settings" > "Rotation Copy Setting" > <input checked="" type="checkbox"/>
<b>Two-sided copying does not take place.</b>	Does the paper type setting of the selected tray specify a type of paper that cannot be used for two-sided copying?	Check "Tray Settings" in the system settings. If the [Disable Duplex] checkbox is selected <input checked="" type="checkbox"/> , two-sided copying using that tray will not be possible. Change the paper type setting to a type that can be used for two-sided printing. → System Settings > "Paper Tray Settings" > "Tray Settings" > "Change"
	Are you using a special size or type of paper?	For the paper types and sizes that can be used for two-sided copying, see "SPECIFICATIONS" in the Start Guide.
	Are you copying using settings that do not allow two-sided copying?	Two-sided copying can generally be combined with other special modes, however, some combinations are not possible. If a prohibited combination is selected, a message will appear in the touch panel.
	Have functions been disabled by the administrator?	Some functions may have been disabled in the system settings (administrator). Check with your administrator. When user authentication is enabled, the functions that you can use may be restricted in your user settings. Check with your administrator.
<b>The paper size of a tray cannot be set.</b>	Have functions been disabled by the administrator?	Some functions may have been disabled in the system settings (administrator). Check with your administrator.

# PROBLEMS RELATED TO COPY RESULTS

Problem	Point to check	Solution
The image is too light or too dark.	Is the image too light or too dark?	<b>Select an appropriate exposure mode for the original being copied and adjust the exposure level manually.</b>
	Has an appropriate exposure mode for the original type been selected?	<b>Select one of the following modes depending on the original type.</b> <ul style="list-style-type: none"> <li>• <b>Text</b> Use this mode for regular text documents.</li> <li>• <b>Text/Prted.Photo</b> This mode provides the best balance for copying an original which contains both text and printed photographs, such as a magazine or catalogue.</li> <li>• <b>Text/Photo</b> This mode provides the best balance for copying an original which contains both text and photographs, such as a text document with a photo pasted on.</li> <li>• <b>Printed Photo</b> This mode is best for copying printed photographs, such as photos in a magazine or catalogue.</li> <li>• <b>Photo</b> Use this mode to copy photos.</li> <li>• <b>Map</b> This mode is best for copying the light colour shading and fine text found on most maps.</li> <li>• <b>Light original</b> Use this mode for originals with light pencil writing.</li> </ul>
Colours are off.	Did you perform "Registration Adjustment"?	<b>Ask your administrator to perform "Registration Adjustment".</b> → System Settings (Administrator) > "Device Control" > "Other Settings" > "Registration Adjustment" If the colour tones are off, perform "Auto Colour Calibration". (If the colours are still off after calibration, repeating calibration may improve the results.) → System Settings (Administrator) > "Copy Function Settings" > "Colour Adjustment" > "Auto Colour Calibration"
Part of the image is cut off.	Has an appropriate ratio been selected for the original size and paper size?	<b>Select an appropriate ratio setting.</b>
	Are you using an inch (AB) size original?	<b>When copying an inch (AB) size original, specify the original size manually.</b>
Copies come out blank.	Is the original placed face up or face down correctly?	<b>When using the document glass, the original must be placed face down. When using the automatic document feeder, the original must be placed face up.</b>

# PRINTING

## PROBLEMS RELATED TO PRINTING OPERATION

- Printing does not take place. . . . . 8-16
- Colour printing does not take place. . . . . 8-18
- Two-sided printing does not take place. . . . . 8-18
- Direct printing of a file in a shared folder on a computer is not possible. . . . . 8-19
- A tray, finisher, or other peripheral device installed on the machine cannot be used. . . . . 8-19

## PROBLEMS RELATED TO PRINT RESULTS



- The image is grainy. . . . . 8-19
- The image is too light or too dark. . . . . 8-19
- Colours are off. . . . . 8-19
- Text and lines are faint and difficult to see. . . . . 8-19
- Part of the image is cut off. . . . . 8-20
- The image is upside down. . . . . 8-20
- Many nonsense characters are printed. . . . . 8-21

- If you cannot find the item that you are looking for in the above table of contents, see "[GENERAL PROBLEMS](#)" (page 8-37).
- If you are unable to solve a problem using the solutions in this manual, switch off the [POWER] key (⏻) and the main power switch. Wait at least 10 seconds, and then switch on the main power switch and the [POWER] key (⏻) in that order.

When the LINE indicator is lit or the DATA indicator is lit or blinking, do not switch off the main power switch or unplug the power plug. This may damage the hard drive or cause the data being stored or received to be lost.

## PROBLEMS RELATED TO PRINTING OPERATION

Problem	Point to check	Solution
Printing does not take place.	Is your computer connected correctly to the machine?	<p><b>Make sure that the cable is connected securely to the LAN connector or the USB connector on your computer and the machine.</b></p> <p>If you are on a network, check the connections at the hub as well.</p> <p>☞ 1. BEFORE USING THE MACHINE "<a href="#">SIDE AND BACK</a>" (page 1-7)</p>
	Is the machine connected to the same network (LAN, etc.) as your computer?	<p><b>The machine must be connected to the same network as your computer.</b></p> <p>If you do not know which network the machine is connected to, ask the network administrator.</p>

Problem	Point to check	Solution
<b>Printing does not take place.</b>	Is the IP address selected correctly? (Windows)	<p><b>Check the IP address setting.</b>            If the machine does not have a permanent IP address (the machine receives an IP address from a DHCP server), printing will not be possible if the IP address changes. Print the "All Custom Setting List" in the system settings and check the IP address of the machine. If the IP address has changed, change the port setting in the printer driver.            → System Settings &gt; "List Print (User)" &gt; "All Custom Setting List"   Software Setup Guide</p> <p>If the IP address changes frequently, it is recommended that a permanent IP address be assigned to the machine.            → System Settings (Administrator) &gt; "Network Settings"</p>
	Are you using a printer port created using Standard TCP/IP Port? (Windows XP/Server 2003/Vista/Server 2008/7/Server 2012/8)	<p><b>Check the settings of your computer.</b>            When a port created with Standard TCP/IP Port in Windows is used and the [SNMP Status Enabled] checkbox is <input checked="" type="checkbox"/>, it may not be possible to print correctly. Change the [SNMP Status Enabled] checkbox to <input type="checkbox"/>.   Software Setup Guide</p>
	Is your computer in an unstable state?	<p><b>Restart your computer.</b>            Printing is sometimes not possible when you run multiple applications at once or there is insufficient memory or hard drive space.</p>
	Is the machine specified correctly in the software application that you are using for printing?	<p><b>Make sure that the printer driver of the machine is selected in the Print window of the application.</b>            If the printer driver does not appear in the list of available printer drivers, it may not be installed correctly. Remove the printer driver and then install it once again.   Software Setup Guide</p>
	Are the network connection devices operating normally?	<p><b>Make sure that the routers and other network connection devices are operating correctly.</b>            If a device is not powered on or is in an error state, see the manual of the device to correct the problem.</p>
	Is the I/O timeout setting too short?	<p><b>Check with your administrator.</b>            If the I/O timeout setting is too short, errors may occur while writing to the printer. Ask the administrator of the machine to configure an appropriate time in "I/O Timeout".            → System Settings (Administrator) &gt; "Printer Settings" &gt; "Interface Settings" &gt; "I/O Timeout"</p>

Problem	Point to check	Solution
<b>Printing does not take place.</b>	Was a Notice Page printed?	<p><b>Check the printed Notice Page.</b>            A Notice Page will be printed to indicate the cause of the problem if a print job cannot be performed as specified and the cause is not shown in the display. Read the printed page and take appropriate action.            For example, a notice page will be printed in the following situations.</p> <ul style="list-style-type: none"> <li>• The print job is too large to fit in memory.</li> <li>• A function that has been prohibited by the administrator is specified.</li> </ul> By factory default, Notice Pages are not printed.
	Have functions been disabled by the administrator?	<p><b>Check with your administrator.</b>            When user authentication is enabled, the functions that you can use may be restricted in your user settings.</p>
<b>Colour printing does not take place.</b>	Is the colour mode set to "Color"?	<p><b>Check the settings of the printer driver.</b>            Select "Automatic" or "Color" for the colour mode setting.            The colour mode setting is configured as follows:            Windows:                On the [Color] tab of the printer driver.            Macintosh:                In the [Color] menu of the print window.            In Windows, [Black and White Print] can also be selected on the [Main] tab of the printer driver. If you wish to print in colour, make sure that the [Black and White Print] checkbox on the [Main] tab is not selected <input type="checkbox"/>.</p>
	Have functions been disabled by the administrator?	<p><b>Check with your administrator.</b>            When user authentication is enabled, the functions that you can use may be restricted in your user settings.</p>
<b>Two-sided printing does not take place.</b>	Does the paper type setting of the selected tray specify a type of paper that cannot be used for two-sided printing?	<p><b>Check "Tray Settings" in the system settings.</b>            If the [Disable Duplex] checkbox is selected <input checked="" type="checkbox"/>, two-sided printing using that tray will not be possible. Change the paper type setting to a type that can be used for two-sided printing.            → System Settings &gt; "Paper Tray Settings" &gt; "Tray Settings" &gt; "Change"</p>
	Are you using a special size or type of paper?	<p><b>For the paper types and sizes that can be used for two-sided printing, see "SPECIFICATIONS" in the Start Guide.</b></p>
	Have functions been disabled by the administrator?	<p><b>Check with your administrator.</b>            Some functions may have been disabled in the system settings (administrator).            When user authentication is enabled, the functions that you can use may be restricted in your user settings.</p>

Problem	Point to check	Solution
Direct printing of a file in a shared folder on a computer is not possible.	Is "IPsec Settings" enabled on the machine?	<b>Check with your administrator.</b> When "IPsec Settings" is enabled in the system settings (administrator), direct printing of a file in a shared folder may not be possible in some computer environments. → System Settings (Administrator) > "Security Settings" > "IPsec Settings"
A tray, finisher, or other peripheral device installed on the machine cannot be used.	Have the peripheral devices that are installed on the machine been configured in the printer driver?	<b>Open the printer properties and click the [Auto Configuration] button on the [Configuration] tab. (Windows)</b> <b>If auto configuration cannot be executed, see the Software Setup Guide.</b>

## PROBLEMS RELATED TO PRINT RESULTS

Problem	Point to check	Solution
The image is grainy.	Are the printer driver settings appropriate for the print job?	<b>Check the settings of the printer driver.</b> When selecting print settings, you can set the print mode to [Normal], [High Quality]. When you need a very clear image, select [High Quality]. Windows: The resolution setting is selected in the [Advanced] tab of the printer driver properties window. Macintosh: Select the resolution in the [Advanced] menu of the print window. (In Mac OS v10.5, select the resolution on the [Color] menu in the print window.)
The image is too light or too dark.	Does the image (particularly a photo) need correction? (Windows)	<b>Check the settings of the printer driver.</b> Brightness and contrast can be corrected by performing [Color Adjustment] on the [Color] tab of the printer driver. These settings can be used for simple corrections when you do not have image editing software installed on your computer.
Colours are off.	Did you perform "Registration Adjustment"?	<b>Ask your administrator to perform "Registration Adjustment".</b> → System Settings (Administrator) > "Device Control" > "Other Settings" > "Registration Adjustment" If the colour tones are off, perform "Auto Colour Calibration". (If the colours are still off after calibration, repeating calibration may improve the results.) → System Settings (Administrator) > "Printer Settings" > "Auto Colour Calibration"
Text and lines are faint and difficult to see.	Was colour data printed in black and white? (Windows)	<b>Check the settings of the printer driver.</b> When colour text and lines are printed in black and white, they may become faint and difficult to see. To have colour text or lines (areas) that are faint converted to black, select [Text To Black] or [Vector To Black] on the [Color] tab of the printer driver. (Raster data such as bitmap images cannot be adjusted.)

Problem	Point to check	Solution
<b>Part of the image is cut off.</b>	Does the paper size specified by the job match the size of paper loaded in the tray?	<p><b>Make sure that the paper size setting matches the size of paper loaded in the tray.</b></p> <p>The paper size setting is selected as follows:</p> <p>Windows:</p> <ul style="list-style-type: none"> <li>On the [Paper] tab of the printer driver.</li> <li>If [Fit to Paper Size] is selected, check the loaded paper and the paper size setting.</li> </ul> <p>Macintosh:</p> <ul style="list-style-type: none"> <li>In the [Page Setup] menu.</li> </ul>
	Is the print orientation setting (portrait or landscape) correct?	<p><b>Set the print orientation to match the image.</b></p> <p>The print orientation is selected as follows:</p> <p>Windows: On the [Main] tab of the printer driver.</p> <p>Macintosh: In the [Page Setup] menu.</p>
	Are the margins set correctly in the layout settings of the application?	<p><b>Select an appropriate paper size and margins in the layout settings of the application.</b></p> <p>If the edge of the image extends outside the printable area of the machine, the edge will be cut off.</p>
<b>The image is upside down.</b>	Are you using a type of paper (tab paper, punch paper, etc.) that can only be loaded in a fixed orientation?	<p><b>Rotate the image 180 degrees before printing.</b></p> <p>When the image size and paper size are the same but the orientations are different, the orientation of the image is automatically rotated to match the paper. However, when the paper can only be loaded in a fixed orientation, this may result in the image being printed upside down.</p> <p>The 180 degree rotation setting is selected as follows:</p> <p>Windows:</p> <ul style="list-style-type: none"> <li>On the [Main] tab of the printer driver.</li> </ul> <p>Macintosh:</p> <ul style="list-style-type: none"> <li>On the [Page Setup] menu. (Landscape orientation only.)</li> </ul>
	Is the correct binding position selected for two-sided printing?	<p><b>Be sure to set the appropriate binding position.</b></p> <p>When two-sided printing is performed, every other page is printed upside down when tablet binding is selected for the binding position.</p> <p>The binding position is selected as follows:</p> <p>Windows:</p> <ul style="list-style-type: none"> <li>On the [Main] tab of the printer driver.</li> </ul> <p>Macintosh:</p> <ul style="list-style-type: none"> <li>In the [Layout] menu of the print window.</li> </ul>



Problem	Point to check	Solution
<p><b>Many nonsense characters are printed.</b></p>	<p>Is your computer or the machine in an unstable state?</p>	<p><b>Cancel printing, restart your computer and the machine, and try printing again.</b></p> <p>If little free space remains in the memory or hard drive of your computer, or many jobs have been spooled on the machine and it has little free memory remaining, printed text may turn into nonsense characters.</p> <p>To cancel printing</p> <p>Windows:</p> <p>Double-click the printer icon that appears at the lower right of the task bar and click "Cancel All Documents" (or "Purge Print Documents") in the [Printer] menu.</p> <p>Macintosh:</p> <p>Double-click the name of the machine in the printer list, select the job that you wish to delete, and delete it.</p> <p>At the machine:</p> <p>Touch the [JOB STATUS] key (  ) on the touch panel, touch the [Print Job] tab to change the screen, touch the key of the print job that you wish to delete, and touch the [Stop/Delete] key. A message appears to confirm the cancellation. Touch the [Yes] key.</p> <p>If nonsense characters are still printed after restarting, ask your administrator to lengthen the timeout setting of "I/O Timeout" in the system settings (administrator).</p> <p>→ System Settings (Administrator) &gt; "Printer Settings" &gt; "Interface Settings" &gt; "I/O Timeout"</p> <p>If nonsense characters are still printed after taking the above measures, remove and then reinstall the printer driver.</p>
<p><b>Second and subsequent pages are not output correctly.</b></p>	<p>Is the size of the data being output too large?</p>	<p>The PCL printer which is installed as standard may cause the second and subsequent pages to not be output correctly if the overall size of the data being output is too large. If this happens, take the following steps to remedy the problem.</p> <ul style="list-style-type: none"> <li>• Reduce the size of the data by lowering the data resolution, etc.</li> <li>• Use the Sharp Advanced Printing Language-c printer driver. Use the productivity kit for peripheral equipment.</li> </ul>

# FACSIMILE

## PROBLEMS RELATED TO TRANSMISSION

- Transmission does not take place. . . . .8-23
- The transmitted fax prints out blank at the receiving side. . . . .8-24
- The transmitted fax is reduced by the receiving fax machine. . . . .8-24
- Transmission does not begin at the specified time. . . . .8-25

## PROBLEMS RELATED TO RECEPTION

- Printing does not take place after reception. . . . .8-25
- Manual reception / polling reception are not possible. . . . .8-25
- The received image is faint. . . . .8-25
- The machine does not begin fax reception. . . . .8-26

## PROBLEMS RELATED TO TELEPHONE

- Dialling is not possible. . . . .8-26
- You cannot talk to the other party. . . . .8-26

## PROBLEMS RELATED TO AUDIBLE SIGNALS

- The volume is too low. . . . .8-26
- No sound is heard. . . . .8-26

## PROBLEMS RELATED TO ONE-TOUCH INDIVIDUAL KEYS / GROUP KEYS

- A one-touch individual key or group key cannot be stored. . . . .8-27
- A one-touch individual key or group key cannot be edited or deleted. . . . .8-27

- If you cannot find the item that you are looking for in the above table of contents, see "GENERAL PROBLEMS" (page 8-37).
- If you are unable to solve a problem using the solutions in this manual, switch off the [POWER] key (⏻) and the main power switch. Wait at least 10 seconds, and then switch on the main power switch and the [POWER] key (⏻) in that order.

When the LINE indicator is lit or the DATA indicator is lit or blinking, do not switch off the main power switch or unplug the power plug. This may damage the hard drive or cause the data being stored or received to be lost.

# PROBLEMS RELATED TO TRANSMISSION

Problem	Point to check	Solution
Transmission does not take place.	Is the telephone line connected securely?	<p><b>Check the telephone line socket, the wall socket, and any extension adapters to make sure that all connections are secure.</b></p> <p>☞ <a href="#">SIDE AND BACK</a> (page 1-7)</p>
	Is the correct dial mode set for your line?	<p><b>Ask your administrator to verify that "Dial Mode Setting" is set correctly for the line you are using.</b></p> <p>→ System Settings (Administrator) &gt; "Image Send Settings" &gt; "Fax Settings" &gt; "Fax Default Settings" &gt; "Dial Mode Setting"</p>
	Is a busy signal received?	<p>If a busy signal is received, the transmission is temporarily cancelled and then automatically re-attempted after a brief interval. (Factory default setting: 2 attempts, 3 min. intervals)</p> <p>→ System Settings (Administrator) &gt; "Image Send Settings" &gt; "Fax Settings" &gt; "Fax Send Settings" &gt; "Recall in Case of Line Busy"</p> <p>To cancel the transmission, touch the [JOB STATUS] key (☞), touch the key of the job that you wish to cancel, and then touch the [Stop/Delete] key.</p>
	Did a communication error occur?	<p>If an error occurs that prevents transmission, the transmission is temporarily cancelled and then automatically re-attempted after a brief interval. (Factory default setting: 3 min. intervals)</p> <p>→ System Settings (Administrator) &gt; "Image Send Settings" &gt; "Fax Settings" &gt; "Fax Send Settings" &gt; "Recall in Case of Communication Error"</p> <p>To cancel the transmission, touch the [JOB STATUS] key (☞), touch the key of the job that you wish to cancel, and then touch the [Stop/Delete] key.</p> <p>The machine supports error correction mode (ECM) and is configured to automatically resend any part of a fax that is distorted due to noise on the line.</p> <p>→ System Settings (Administrator) &gt; "Image Send Settings" &gt; "Fax Settings" &gt; "Fax Default Settings" &gt; "ECM"</p>
	Does a message appear indicating that the memory is full?	<p><b>Divide the originals into sets and fax each set separately, or use direct transmission.</b></p> <p>If the memory becomes full, the transmission will be cancelled.</p>
	Does a message appear notifying you that the original size was not detected?	<p><b>Place the original again.</b></p> <p>If the original size is still not detected correctly, specify the original size manually.</p>

Problem	Point to check	Solution
<b>Transmission does not take place.</b>	Does the job status screen (completed jobs) or a transaction report indicate that the transmission was not successful?	<p><b>Perform the transmission again.</b></p> <p>If the transmission is still not successful after recalling is performed as set in "Recall in Case of Line Busy" or "Recall in Case of Communication Error", the transmission failure will be indicated in the job status screen and the transaction report.</p> <p>→ System Settings (Administrator) &gt; "Image Send Settings" &gt; "Fax Settings" &gt; "Fax Send Settings" &gt; "Recall in Case of Line Busy"</p> <p>→ System Settings (Administrator) &gt; "Image Send Settings" &gt; "Fax Settings" &gt; "Fax Send Settings" &gt; "Recall in Case of Communication Error"</p>
	Did you place a long size original on the document glass when it is scanned?	<p><b>Place originals in the document feeder tray of the automatic document feeder.</b></p> <p>A long size original cannot be scanned from the document glass.</p>
	Did you place an original that is folded?	<p><b>Following the instructions in the display, unfold the original, place it in the automatic document feeder again, and rescan.</b></p> <p>If a folded original is placed in the automatic document feeder, an error will occur and scanning will be cancelled when the actual original size is detected during scanning.</p>
	Are the sub-address and passcode correct? (When using F-code communication)	<p><b>Check with the operator of the other machine to make sure that the sub-address and passcode are correct.</b></p>
	Have functions been disabled by the administrator?	<p><b>Check with your administrator.</b></p> <p>When user authentication is enabled, the functions that you can use may be restricted in your user settings.</p>
<b>The transmitted fax prints out blank at the receiving side.</b>	Is the original placed face up or face down correctly?	<p><b>Place the original correctly and send the fax again.</b></p> <p>When using the document glass, the original must be placed face down. When using the automatic document feeder, the original must be placed face up.</p>
	If the receiving machine is using thermal paper, was the thermal paper loaded with the wrong side out?	<p><b>Check with the operator of the other machine.</b></p>
<b>The transmitted fax is reduced by the receiving fax machine.</b>	Has image rotation been enabled?	<p><b>Enable "Rotation Sending Settings" before transmission.</b></p> <p>When "Rotation Sending Setting" is not enabled (the image is not rotated), an original placed in the vertical orientation may be reduced by the receiving machine.</p> <p>→ System Settings (Administrator) &gt; "Image Send Settings" &gt; "Fax Settings" &gt; "Fax Send Settings" &gt; "Rotation Sending Setting" &gt; <input checked="" type="checkbox"/></p> <p>If "Mixed Size Originals" in the special modes is enabled and an original with a different width is sent, rotate transmission will be disabled.</p>

Problem	Point to check	Solution
Transmission does not begin at the specified time.	Is the machine's clock set to the correct time?	<b>Set the clock to the correct time.</b> → System Settings > "Default Settings" > "Clock" > "Clock Adjust"
	Is a transmission in progress?	If another transmission is in progress when the specified time arrives, the timer operation will begin after that transmission is finished.

## PROBLEMS RELATED TO RECEPTION

Problem	Point to check	Solution
Printing does not take place after reception.	Does a message appear in the display instructing you to add toner or paper? (Printing is not possible when this screen appears.)	<b>Restore printing capability as instructed by the message.</b>
	Does a password entry screen appear?	<b>Enter the correct password with the numeric keys.</b> "Hold Setting for Received Data Print" is enabled. If you do not know the password, check with your administrator.
	Has cut-off printing been disabled in the system settings (administrator)?	<b>Load the same size of paper as the received fax.</b> If "Print Actual Size Cut off Disabled" is enabled in "Print Style Setting" in the system settings (administrator) and a fax is received that is larger than any paper that is loaded, the fax will be received to memory without being printed. (However, when a fax longer than A3 (11" x 17") size is received, it will be printed using multiple sheets of paper.)
	Is forwarding (Inbound Routing function) selected in the Web page for a received fax?	<b>If you need to print a received fax, ask your administrator.</b> When the Inbound Routing function is enabled in the Web pages, received faxes are automatically forwarded to a specified address. If "Print at Error" is selected when Inbound Routing is enabled, received faxes will only be printed when an error occurs.
Manual reception / polling reception are not possible.	Is little free memory remaining?	Free memory by printing faxes received by confidential reception and other received data that is protected by a password, and by deleting data stored in memory boxes.
The received image is faint.	Is the original that was faxed also faint?	<b>Ask the other party to send the fax again using a suitable (darker) exposure setting.</b>

Problem	Point to check	Solution
<b>The machine does not begin fax reception.</b>	Has the reception mode been set to "Manual Reception" in the system settings?	<b>Set the reception mode to "Auto Reception".</b> When the reception mode is set to "Manual Reception", the machine will not receive faxes automatically. → System Settings > "Fax Data Receive/Forward" > "Fax Settings" > "Receive Setting"
	Is little free memory remaining?	<b>Increase the amount of free memory.</b> The amount of free memory can be increased by printing faxes received by confidential reception and other password-protected received data, and by deleting data stored in memory boxes.

## PROBLEMS RELATED TO TELEPHONE

Problem	Point to check	Solution
<b>Dialling is not possible.</b>	Is the extension phone connected?	<b>Check connections.</b> Check the telephone line socket, the extension phone socket, the wall socket, and any extension adapters to make sure that all connections are secure.
<b>You cannot talk to the other party.</b>	Did you dial using the speaker?	<b>Use the extension phone.</b> When you dial using the speaker, you will be able to hear the voice of the other party, but he or she will not hear your voice. (When the extension phone is not installed, you cannot talk to the other party.)

## PROBLEMS RELATED TO AUDIBLE SIGNALS

Problem	Point to check	Solution
<b>The volume is too low.</b> <ul style="list-style-type: none"> <li>• Speaker</li> <li>• Ringer Volume</li> <li>• Line Monitor</li> <li>• Fax Receive Complete Signal</li> <li>• Fax Send Complete Signal</li> <li>• Fax Communication Error Signal</li> </ul>	Has the volume been set to a low level in the system settings (administrator)?	<b>Ask your administrator to set the volumes in "Speaker Settings" to a higher level.</b> → System Settings (Administrator) > "Image Send Settings" > "Fax Settings" > "Fax Default Settings" > "Speaker Settings"
<b>No sound is heard.</b> <ul style="list-style-type: none"> <li>• Ringer Volume</li> <li>• Line Monitor</li> <li>• Fax Receive Complete Signal</li> <li>• Fax Send Complete Signal</li> <li>• Fax Communication Error Signal</li> </ul>	Has the ringer volume been turned off in the system settings (administrator)?	<b>Ask your administrator to set the volumes in "Speaker Settings" to other than "No Sound".</b> → System Settings (Administrator) > "Image Send Settings" > "Fax Settings" > "Fax Default Settings" > "Speaker Settings"

# PROBLEMS RELATED TO ONE-TOUCH INDIVIDUAL KEYS / GROUP KEYS

Problem	Point to check	Solution
A one-touch individual key or group key cannot be stored.	Has the maximum number of keys been stored?	<b>Delete one-touch keys and group keys that are not being used.</b>
	Have functions been disabled by the administrator?	<b>Check with your administrator.</b> Some functions may have been disabled in the system settings (administrator).
A one-touch individual key or group key cannot be edited or deleted.	If the key is an individual key, is the key included in a group?	<b>Remove the key from the group and then edit or delete the key.</b> (If the key is included in multiple groups, it must be removed from all groups.) → System Settings > "Address Control" > "Address Book"  If multiple group keys have been stored, print the Group List in "Sending Address List" in the system settings. The list will show where the key is stored. → System Settings > "List Print (User)" > "Sending Address List" > "Group List"
	Is the key being used in a reserved transmission or a transmission in progress?	<b>Wait until the transmission is finished or cancel the transmission and then edit or delete the key.</b>
	Is the key included in a program key?	<b>Remove the key from the program and then edit or delete the key.</b> (If the key is included in multiple programs, it must be removed from all programs.) → System Settings > "Address Control" > "Program"  If multiple program keys have been stored, print the Program List in "Sending Address List" in the system settings. The list will show where individual and group keys are stored. → System Settings > "List Print (User)" > "Sending Address List" > "Program List"
	Is the key that you wish to edit or delete stored as a relay destination of an F-code relay broadcast transmission?	<b>Remove the key from the relay destinations of the F-code relay broadcast transmission and then edit or delete the key.</b> An individual or group one-touch key that is stored as a relay destination cannot be edited or deleted. → System Settings > "Address Control" > "F-Code Memory Box"
	Have functions been disabled by the administrator?	<b>Check with your administrator.</b> Some functions may have been disabled in the system settings (administrator).
	Has your administrator enabled a function that prevents editing/deleting?	<b>Check with your administrator.</b> If your administrator has enabled settings such as "Inbound Routing Settings" (in the Web pages), editing/deleting will not be possible.

# SCANNING / INTERNET FAX

## PROBLEMS RELATED TO SCANNING / INTERNET FAX OPERATION

- Transmission does not take place. . . . . 8-28
- An address cannot be specified. . . . . 8-29
- Mode cannot be selected. . . . . 8-29
- Auto selection of the colour mode does not take place correctly. . . . . 8-29
- The received image file cannot be opened. . . . . 8-30
- Transmission takes a long time. . . . . 8-30
- A destination is pre-selected. . . . . 8-30
- Cannot write to USB memory. (When using USB Memory Scan.) . . . . . 8-30

## PROBLEMS RELATED TO SCAN RESULTS

- The scanned image is clipped. . . . . 8-30
- The quality of the scanned image is poor. . . . . 8-31
- The scanned image is blank. . . . . 8-31
- The scanned image is upside down or on its side. . . . . 8-31
- The [COLOUR START] key indicator is not lit. . . . . 8-31
- JPEG was selected for the file type but the file was created as a TIFF file. . . . . 8-31
- The image is too light or too dark. (When using PC Scan.) . . . . . 8-32

## PROBLEMS RELATED TO ONE-TOUCH INDIVIDUAL KEYS / GROUP KEYS

- A one-touch individual key or group key cannot be stored. . . . . 8-32
- A one-touch individual key or group key cannot be edited or deleted. . . . . 8-32

- If you cannot find the item that you are looking for in the above table of contents, see "GENERAL PROBLEMS" (page 8-37).
- If you are unable to solve a problem using the solutions in this manual, switch off the [POWER] key (⏻) and the main power switch. Wait at least 10 seconds, and then switch on the main power switch and the [POWER] key (⏻) in that order.

When the LINE indicator is lit or the DATA indicator is lit or blinking, do not switch off the main power switch or unplug the power plug. This may damage the hard drive or cause the data being stored or received to be lost.

## PROBLEMS RELATED TO SCANNING / INTERNET FAX OPERATION

Problem	Point to check	Solution
Transmission does not take place.	Did you select the correct destination? Is the correct information (e-mail address or FTP server information) stored for that destination?	<b>Make sure that the correct destination information is stored for the destination and that the destination is correctly selected.</b> If delivery by e-mail (Scan to E-mail) is unsuccessful, an error message such as "Undelivered Message" may be sent to the designated administrator's e-mail address. This information may help you determine the cause of the problem.



Problem	Point to check	Solution
<b>Transmission does not take place.</b>	Does the image file exceed the e-mail attachment limit set in the system settings (administrator)?	<b>Check with your administrator.</b> If your administrator has set a limit on the size of transmitted files, a file that exceeds the limit cannot be transmitted.
	Did the image file exceed the file attachment size limit of your mail server? (When Scan to E-mail is used.)	<b>Reduce the size of the file attachment (reduce the number of pages scanned).</b> The size of the file can also be reduced by scanning using a lower resolution setting. Ask your mail server administrator what the file size limit is for one e-mail transmission.
	Has the folder on the destination computer been set as a shared folder so that files can be sent to it? (When using Scan to Network Folder.)	<b>If the destination folder is not configured as a shared folder, select "share" in the folder properties.</b> If the folder was moved or otherwise changed, the "share" setting may have been cancelled.
	Is "IPsec Settings" enabled on the machine? (When using Scan to Network Folder.)	<b>Consult your administrator.</b> When "IPsec Settings" is enabled in the system settings (administrator), scanning to a shared folder may not be possible in some computer environments. → System Settings (Administrator) > "Security Settings" > "IPsec Settings"
	Did you place a long size original on the document glass when it is scanned?	<b>Place originals in the document feeder tray of the automatic document feeder.</b> A long size original cannot be scanned from the document glass.
	Did you place an original that is folded?	<b>Following the instructions in the display, unfold the original, place it in the automatic document feeder again, and rescan.</b> If a folded original is placed in the automatic document feeder, an error will occur and scanning will be cancelled when the actual original size is detected during scanning.
<b>An address cannot be specified.</b>	Have functions been disabled by the administrator?	<b>Check with your administrator.</b> Some functions may have been disabled in the system settings (administrator). When user authentication is enabled, the functions that you can use may be restricted in your user settings.
<b>Mode cannot be selected.</b>		
<b>Auto selection of the colour mode does not take place correctly.</b>	Are you scanning one of the following types of originals? <b>When Black &amp; White is not selected:</b> <ul style="list-style-type: none"> <li>• Are there colours or colouring in the paper?</li> </ul> <b>When Colour is not selected:</b> <ul style="list-style-type: none"> <li>• Is the colour in the original very light?</li> <li>• Is the colour in the original very dark, almost black?</li> <li>• Is only a very small area of the original coloured?</li> </ul>	<b>Specify the colour mode manually.</b> When the colour mode is set to "Auto", the machine detects whether the original is black and white or colour when the [COLOUR START] key is pressed; however, in the cases at left, automatic detection may not give the correct result.

Problem	Point to check	Solution
The received image file cannot be opened.	Does the viewer program used by the recipient support the format of the received image data?	<b>Use a software program that is capable of opening the selected file type and compression mode.</b> The recipient may be able to open the file if you change the file type and compression mode selected at the time of transmission.
	Does a message appear prompting you to enter your password?	<b>Ask the sender for the password, or have the image sent again in a non-encrypted format.</b> The received file is an encrypted PDF file.
Transmission takes a long time.	Is the resolution setting appropriate at the time of scanning?	<b>Select resolution and data compression settings that are suited to the purpose of transmission.</b> To create image data that is balanced in terms of resolution and file size, pay attention to the following points: Resolution settings The default resolution setting is [200X200dpi] in scanner and USB memory mode, and [200X100dpi] in Internet fax mode. If the original does not contain a halftone image such as a photo or illustration, scanning at the default resolution will create a practical and useful image. A higher resolution setting or the "Half Tone" setting (in Internet fax mode) should only be selected if the original contains a photo and you wish to give priority to the quality of the photo image. Exercise caution in this case as a larger file will be created than when the default setting is used.
A destination is pre-selected.	Is "Default Address Setting" enabled in the system settings (administrator)?	<b>If you wish to send to a destination other than the default destination, touch the [Cancel] key.</b> If you are the administrator and wish to change or disable the default destination, change the settings as appropriate in "Default Address Setting". → System Settings (Administrator) > "Image Send Settings" > "Scan Settings" > "Default Address Setting"
Cannot write to USB memory. (When using USB Memory Scan.)	Is the connected USB device recognized correctly?	<b>Use "USB-Device Check" in the system settings to check whether or not the device can be recognized.</b> → System Settings > "USB-Device Check" If it is not recognized, connect it once again.

## PROBLEMS RELATED TO SCAN RESULTS

Problem	Point to check	Solution
The scanned image is clipped.	Is the original scan size setting smaller than the actual original size?	<b>Set the scan size to the actual original size.</b> If you have intentionally set a smaller size than the actual original size, note carefully the placement position of the selected scan size when placing the original. For example, when scanning an A4 (8-1/2" x 11") original using a B5 (5-1/2" x 8-1/2") setting on the document glass, align the original using the document glass scale at the left edge to fit the area you wish to scan into the B5 (5-1/2" x 8-1/2") scanning area.  1. BEFORE USING THE MACHINE "PLACING THE ORIGINAL ON THE DOCUMENT GLASS" (page 1-40)

Problem	Point to check	Solution
The quality of the scanned image is poor.	Is the original printed matter such as a book or magazine?	<p><b>Use the following method to reduce the occurrence of vertical patterns (moiré)</b></p> <p>When the original is printed matter, vertical patterns (moiré) may occur. Touch the [Exposure] key in the base screen to open the exposure setting screen. The [Moiré Reduction] checkbox appears in this screen. This checkbox can be selected <input checked="" type="checkbox"/> to reduce the moiré effect. (only in scan mode and USB memory scan mode)</p> <p>It may also be possible to reduce the moiré effect by changing the resolution setting or shifting the original (or changing its angle) slightly on the document glass.</p>
	When scanning a colour or greyscale original, is the colour mode set to "Mono2"?	Setting the colour mode to "Mono2" replaces the colours in the original with either black or white. This is suitable for text-only originals; however, for originals that contain illustrations, it is best to use the [BLACK & WHITE START] key with the colour mode set to [Greyscale], or set the colour mode of the [COLOUR START] key to [Full Colour] or [Auto]-[Greyscale] and then scan.
	Is a destination included that has [TIFF-S] selected for the format?	<p><b>If you wish to send an image scanned at high resolution to scan mode destinations, send the image in a separate transmission.</b></p> <p>When a broadcast transmission is performed that includes both scan mode destinations and Internet fax destinations that have [TIFF-S] selected for the format, the resolution will remain fixed at [200X200dpi] even if a different resolution setting is selected.</p>
The scanned image is blank.	Is the original placed face up or face down correctly?	<p><b>Reload the thermal paper correctly and send the fax again.</b></p> <p>When using the document glass, the original must be placed face down. When using the automatic document feeder, the original must be placed face up.</p>
The scanned image is upside down or on its side.	Are Internet fax addresses included in the transmission?	<p><b>Send the image to the scan mode destinations in a separate transmission.</b></p> <p>When both scan mode and Internet fax destinations are included in a broadcast transmission, the original transmission orientation of Internet fax takes precedence, and thus the file may not appear in the correct orientation when viewed on a computer.</p>
The [COLOUR START] key indicator is not lit.	Are Internet fax or fax destinations included?	<p><b>Use the [BLACK &amp; WHITE START] key.</b></p> <p>If Internet fax or fax destinations are included in the destinations, only the [BLACK &amp; WHITE START] key can be used.</p>
JPEG was selected for the file type but the file was created as a TIFF file.	Did you press the [BLACK & WHITE START] key to begin scanning?	<p><b>Change the colour mode to [Full Colour] and then press the [COLOUR START] key.</b></p> <p>When [JPEG] is selected for the file type and the image is scanned in Mono 2, the file will be created as a TIFF file.</p>

Problem	Point to check	Solution
The image is too light or too dark. (When using PC Scan.)	Is the threshold value suitable?	<b>Check the "B/W Threshold" setting.</b> When scanning from the TWAIN driver with [Mono 2 gradation] selected from the [Colour Mode] of the "Custom Settings" window, check the "B/W Threshold" setting. A large threshold value makes the image darker and a small threshold value makes the image brighter. To adjust the "B/W Threshold" automatically, click the [Auto Threshold] button on the [Image] tab of the "Custom Settings" window.
	Are the brightness and contrast settings suitable?	When the brightness and contrast settings are not suitable (for example, the scanned image is too bright), click the [Auto Brightness / Contrast Adjustment] button on the [Colour] tab of the "Custom Settings" window. You can also click the [Brightness / Contrast] button to set the brightness and contrast while viewing the scanned image.

## PROBLEMS RELATED TO ONE-TOUCH INDIVIDUAL KEYS / GROUP KEYS

Problem	Point to check	Solution
A one-touch individual key or group key cannot be stored.	Has the maximum number of keys been stored?	<b>Adjust the number of stored keys.</b> Delete one-touch keys (or group keys) that are not being used.
	Have functions been disabled by the administrator?	<b>Check with your administrator.</b> Some functions may have been disabled in the system settings (administrator).
A one-touch individual key or group key cannot be edited or deleted.	If the key is an individual key, is the key included in a group?	<b>Remove the key from the group and then edit or delete the key.</b> (If the key is included in multiple groups, it must be removed from all groups.) → System Settings > "Address Control" > "Address Book"  If multiple group keys have been stored, print the Group List in "Sending Address List" in the system settings. The list will show where the key is stored. → System Settings > "List Print (User)" > "Sending Address List" > "Group List"
	Is the key being used in a reserved transmission or a transmission in progress?	<b>Wait until the transmission is finished or cancel the transmission and then edit or delete the key.</b>

Problem	Point to check	Solution
<p><b>A one-touch individual key or group key cannot be edited or deleted.</b></p>	<p>Is the key included in a program key?</p>	<p><b>Remove the key from the program and then edit or delete the key.</b>            (If the key is included in multiple programs, it must be removed from all programs.)            → System Settings &gt; "Address Control" &gt; "Program"</p> <p>If multiple program keys have been stored, print the Program List in "Sending Address List" in the system settings. The list will show where individual and group keys are stored.            → System Settings &gt; "List Print (User)" &gt; "Sending Address List" &gt; "Program List"</p>
	<p>Have functions been disabled by the administrator?</p>	<p><b>Check with your administrator.</b>            Some functions may have been disabled in the system settings (administrator).</p>
	<p>Has your administrator enabled a function that prevents editing/deleting?</p>	<p><b>Check with your administrator.</b>            If your administrator has enabled "Default Address Setting" (on the machine) or "Inbound Routing Settings" (in the Web pages), editing/deleting will not be possible.</p>

# DOCUMENT FILING

## PROBLEMS RELATED TO FILING

- Document filing does not take place. . . . . 8-34
- A filed data can not be printed. . . . . 8-34
- A job cannot be stored in a custom folder. . . . . 8-35

## PROBLEMS RELATED TO FILE MANAGEMENT

- A stored file has disappeared. . . . . 8-35
- A file cannot be deleted. . . . . 8-35
- The property of a file cannot be set to [Confidential]. . . . . 8-35
- A confidential file or confidential folder cannot be opened.. . . . 8-35
- A file name cannot be stored or changed. . . . . 8-35
- A custom folder name cannot be stored or changed. . . . . 8-35
- A file name is cut off.. . . . 8-36

• If you cannot find the item that you are looking for in the above table of contents, see "[GENERAL PROBLEMS](#)" (page 8-37).

• If you are unable to solve a problem using the solutions in this manual, switch off the [POWER] key (⏻) and the main power switch. Wait at least 10 seconds, and then switch on the main power switch and the [POWER] key (⏻) in that order.

When the LINE indicator is lit or the DATA indicator is lit or blinking, do not switch off the main power switch or unplug the power plug. This may damage the hard drive or cause the data being stored or received to be lost.

## PROBLEMS RELATED TO FILING

Problem	Point to check	Solution
<b>Document filing does not take place.</b>	Did you select document filing settings in the printer driver?	<b>Enable document filing settings.</b> In print mode, enable document filing on the [Job Handling] tab of the printer driver. In copy mode or image send mode, touch the [Quick File] key or the [File] key and then use the document filing function.
	Have functions been disabled by the administrator?	<b>Check with your administrator.</b> Some functions may have been disabled in the system settings (administrator). Check with your administrator. When user authentication is enabled, the functions that you can use may be restricted in your user settings.
<b>A filed data can not be printed.</b>	Have functions been disabled by the administrator?	<b>Check with your administrator.</b> Some functions may have been disabled in the system settings (administrator). Check with your administrator. When user authentication is enabled, the functions that you can use may be restricted in your user settings.

Problem	Point to check	Solution
A job cannot be stored in a custom folder.	Do custom folders appear in "Folder Information"? (When printing)	Click the [Get Folder Name] button in the document filing save screen of the printer driver to call up the custom folders that have been created on the machine.
	Does the custom folder have a password?	Enter the password configured in the machine in the document filing save screen.

## PROBLEMS RELATED TO FILE MANAGEMENT

Problem	Point to check	Solution
A stored file has disappeared.	Did you touch the [Print and Delete the Data] key to print a stored file?	<b>Use the [Print and Save the Data] key.</b> A file that is printed using the [Print and Delete the Data] key is automatically deleted after being printed. The file property can be set to "Protect" to prevent the file from being easily deleted.
	Has automatic deletion of document filing files been enabled?	<b>If files that you need have been deleted, consult the administrator of the machine.</b> When "Automatic Deletion of File Settings" is enabled in the system settings (administrator), the files in the specified folders are periodically deleted. (Even when the file property is "Confidential" or "Protect", the file may be deleted.)
A file cannot be deleted.	Is the property of the file set to [Protect]?	<b>Change the property to [Sharing] and then delete the file.</b> A file cannot be deleted when its property is set to [Protect].
The property of a file cannot be set to [Confidential].	Is the file in the Quick File folder?	<b>Move the file to a different folder and then specify "Confidential".</b> "Confidential" cannot be specified for a file in the Quick File folder. (Note that "Protect" can be specified for a file in the Quick File folder to prevent it from being easily deleted.)
A confidential file or confidential folder cannot be opened.	Did you enter the wrong password?	<b>Ask your administrator.</b> If you cannot remember the password, it is possible to change the file or folder password to a new password in the system settings (administrator).
A file name cannot be stored or changed.	Does the name include characters that cannot be used in a file or folder name?	<b>The following characters cannot be used in a file or folder name:</b> \\ ? / " ; : , < > ! * & #
A custom folder name cannot be stored or changed.		

Problem	Point to check	Solution
<b>A file name is cut off.</b>	Was the file name stored in the advanced transmission settings during a scan or Internet fax transmission?	If the name was stored in the advanced transmission settings before Quick File or File settings were configured, that name will be used for the stored file. If the number of characters in the name exceeds the maximum number of characters allowed for a Quick File name (30 characters), the characters after the 30th character will be discarded.



# GENERAL PROBLEMS

## PROBLEMS RELATED TO MACHINE OPERATION

- Specified machine functions cannot be used. . . . . 8-39
- The operation panel cannot be used. . . . . 8-39
- Printing is not possible or stops during a job. . . . . 8-40
- The original size is not automatically selected or the wrong size is selected. . . . . 8-40
- The displayed bypass tray paper size is not correct. . . . . 8-40

## PROBLEMS RELATED TO PAPER FEEDING AND OUTPUT

- The original misfeeds (automatic document feeder). . . . . 8-41
- The paper misfeeds. . . . . 8-41
- Paper does not feed from the paper tray. . . . . 8-42
- The image on paper is skewed. . . . . 8-42
- The automatic document feeder does not operate. . . . . 8-42

## PROBLEMS RELATED TO QUALITY / PRINT RESULTS

- Lines appear in the scanned image. . . . . 8-43
- Smudges appear on printed output. . . . . 8-43
- Toner does not adhere well or creases appear in the paper. . . . . 8-43
- Print quality is poor. . . . . 8-43
- Part of the image is cut off. . . . . 8-44
- Printing takes place on the wrong side of the paper. . . . . 8-44
- A cover or insert is not printed on the specified paper. . . . . 8-44

## PROBLEMS RELATED TO PERIPHERAL DEVICES

- The connected USB device cannot be used. . . . . 8-45
- The connected USB memory cannot be used. . . . . 8-45
- The finisher does not operate. . . . . 8-45
- Stapling does not take place. . . . . 8-45
- Punching does not take place. . . . . 8-46
- The stapling position or punch position is not correct. . . . . 8-46
- Sheets output to the delivery tray of the finisher are scattered. . . . . 8-46
- The stapled sheets are scattered. . . . . 8-46

**OTHER PROBLEMS**

- Preview images or thumbnail images do not appear.....8-47
- The touch panel screen is difficult to view.....8-47
- You were logged out without having performed logout yourself. ....8-47
- You forgot the administrator password. ....8-47

If you are unable to solve a problem using the solutions in this manual, switch off the [POWER] key (⏻) and the main power switch. Wait at least 10 seconds, and then switch on the main power switch and the [POWER] key (⏻) in that order.

When the LINE indicator is lit or the DATA indicator is lit or blinking, do not switch off the main power switch or unplug the power plug. This may damage the hard drive or cause the data being stored or received to be lost.

# PROBLEMS RELATED TO MACHINE OPERATION

Problem	Point to check	Solution
<b>Specified machine functions cannot be used.</b>	Have functions been disabled by the administrator?	<b>Check with your administrator.</b> Some functions may have been disabled in the system settings (administrator). Check with your administrator. When user authentication is enabled, the functions that you can use and page counts may be restricted in your user settings.
<b>The operation panel cannot be used.</b>	Is the main power indicator lit?	<b>If the main power indicator is not lit, turn on the power.</b> Make sure that the power plug is firmly inserted in the power outlet, switch the main power switch to the "on" position, and press the [POWER] key (⏻) to turn on the power.
	Did you just power on the machine?	<b>Wait until a message appears indicating that the machine is ready.</b> After the [POWER] key (⏻) is turned on, the machine requires some time to complete warmup operation. During this time functions can be selected, however, a job cannot be run.
	Is the [POWER SAVE] key (⏻) blinking?	<b>Press the [POWER SAVE] key (⏻) to turn off Auto Power Shut off mode.</b> 1. BEFORE USING THE MACHINE "[POWER SAVE] KEY" (page 1-16)
	Is a cover open or a device separated from the machine?	<b>Read the message and take appropriate action.</b> A warning message will appear when a cover is open or a device is separated from the machine.
	Did login fail three times in a row?	<b>Log in using the correct user information.</b> When "A Warning when Login Fails" is enabled in the system settings (administrator) and login fails 3 times in a row, a warning will be displayed and operation will lock for 5 minutes. After operation unlocks, log in using the correct user information. (If you do not know your user information, contact your administrator.)
	Does a message appear indicating that Auto Login failed?	<b>Contact your administrator.</b> Auto Login failed due to a problem on the network. If you are the administrator, touch the [Admin Password] key, log in as an administrator, and temporarily change the auto login settings in the system settings (administrator). (Restore the changed settings to their original state after the network problem has been solved.)
<b>The operation panel cannot be used.</b>	Does the message "Call for service. Code:xx-xx*" appear in the touch panel? *Letters and numbers appear in xx-xx.	<b>Switch the power off and then restart the machine.</b> Make sure that the LINE indicator is not lit and that the DATA indicator is not blinking or lit and then switch off the [POWER] key (⏻) and the main power switch. Wait at least 10 seconds and then switch the main power switch and the [POWER] key (⏻) back on in that order. If the message still appears after switching the [POWER] key (⏻) and main power switch off and on several times, it is likely that a failure has occurred that requires service. In this event, stop using the machine, unplug the power plug, and contact your dealer or nearest authorised service representative. (When contacting your dealer or nearest authorised service representative, inform them of the displayed error code.)



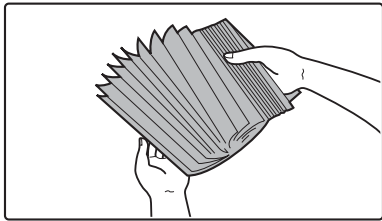

Problem	Point to check	Solution
Printing is not possible or stops during a job.	Is a tray out of paper?	<b>Add paper as instructed by the message in the touch panel.</b>
	Is the machine out of toner?	<b>Replace the toner cartridge.</b> When toner runs low, a message will appear to inform you that the toner cartridge must be replaced. To replace the toner cartridge, see "MAINTENANCE" (page 1-52) in "1. BEFORE USING THE MACHINE".
	Has a paper misfeed occurred?	<b>Remove the misfeed as instructed by the message in the touch panel.</b> ➤ REMOVING MISFEEDS (page 8-8)
	Is the output tray full?	<b>Remove the output from the tray and resume printing.</b> When the output tray becomes full, a detector activates and stops printing.
	Is the waste toner box full?	<b>Replace the waste toner box as instructed by the message in the touch panel.</b> ➤ 1. BEFORE USING THE MACHINE "MAINTENANCE" (page 1-52)
	In the Paper Tray Settings of the system settings, are restrictions placed on the trays that can be used in each mode (copy, print, fax, Internet fax, and document filing)?	<b>Check the Paper Tray Settings and see if checkmarks appear in the checkboxes of each mode (Feeding Approved Job).</b> Functions without a checkmark cannot be used for printing using that tray. → System Settings > "Paper Tray Settings" > "Tray Settings" > "Change" > <input checked="" type="checkbox"/> (Each mode)
The original size is not automatically selected or the wrong size is selected.	Is the original curled or folded?	<b>Straighten the original.</b> The correct original size cannot be detected if the original is curled or folded.
	Did you place an original smaller than A5 (5-1/2" x 8-1/2") size?	<b>Enter the original size manually.</b> Original sizes smaller than A5 (5-1/2" x 8-1/2") cannot be detected. When scanning a small original on the document glass, it is convenient to place a blank sheet of paper on top of the original which is the same size (A4 (8-1/2" x 11"), B5 (8-1/2" x 11"R), etc.) as the paper that you wish to use for printing.
The displayed bypass tray paper size is not correct.	Is the bypass tray extension pulled out?	<b>Pull out the bypass tray extension.</b> When loading paper in the bypass tray, be sure to pull out the extension to enable the paper size to be detected correctly.

# PROBLEMS RELATED TO PAPER FEEDING AND OUTPUT

Problem	Point to check	Solution
<b>The original misfeeds (automatic document feeder).</b>	Is too much paper loaded in document feeder tray?	<b>Make sure that the stack of paper in the tray is not higher than the indicator line.</b>
	Is the original a long original?	<b>When using the automatic document feeder to scan a long original, set the scan size to [Long Size].</b> (Note that long originals cannot be copied using the copy function.)
	Is the original on thin paper?	<b>Use the document glass to scan the original.</b> If you need to use the automatic document feeder, use slow scan mode in the special modes to scan the original.
	Is the feed roller dirty?	<b>Clean the surface of the original feed roller.</b> ☞ 1. BEFORE USING THE MACHINE "MAINTENANCE" (page 1-52)
<b>The paper misfeeds.</b>	Is a torn piece of paper remaining in the machine?	<b>Make sure all paper is removed.</b> ☞ REMOVING MISFEEDS (page 8-8)
	Is too much paper loaded in the tray?	<b>Make sure that the stack of paper in the tray is not higher than the indicator line.</b>
	Are multiple sheets feeding at once?	<b>Fan the paper well before loading it.</b> 
	Are you using paper that is not within the specifications?	<b>Use SHARP-recommended paper.</b> Using paper that is not supported may result in misfeeds, creases, or smudges. ☞ "SUPPLIES" in the Start Guide For paper that is prohibited or not recommended, see "USEABLE PAPER" (page 1-28) in "1. BEFORE USING THE MACHINE".
	Has the paper in the tray absorbed moisture?	If you will not be using paper in a tray for a long time, remove the paper from the tray and store it in a bag in a dark and dry location.
	Are the bypass tray guides adjusted to the width of the paper?	<b>Adjust the bypass tray guides to the width of the paper.</b>
	Is the bypass tray extension pulled out?	<b>When loading a large size of paper, pull out the extension.</b>
	Is the bypass feed roller dirty?	<b>Clean the surface of the bypass feed roller.</b> ☞ 1. BEFORE USING THE MACHINE "MAINTENANCE" (page 1-52)

Problem	Point to check	Solution
<b>The paper misfeeds.</b>	Is A5 (5-1/2" x 8-1/2") size paper loaded?	<b>When loading A5 (5-1/2" x 8-1/2") size paper, place the paper in the horizontal (A5R (5-1/2" x 8-1/2"R)) orientation.</b>
	Has the correct paper size been set?	<b>If you are using a special size, be sure to specify the paper size.</b> If the size of paper loaded in a tray was changed, be sure to check the paper size setting. → System Settings > "Paper Tray Settings" > "Tray Settings"
	Did you add paper to the bypass tray?	<b>When adding paper, remove any paper remaining in the bypass tray, combine it with the paper to be added, and reload as a single stack.</b> If paper is added without removing the remaining paper, a misfeed may result.
<b>Paper does not feed from the paper tray.</b>	Is the paper loaded correctly in the paper tray?	<b>Set the guides to the size of the paper.</b> Make sure the height of the paper does not exceed the indicator line.
	In the Paper Tray Settings of the system settings, are restrictions placed on the trays that can be used in each mode (copy, print, fax, Internet fax, and document filing)?	<b>Check the Paper Tray Settings and see if checkmarks appear in the checkboxes of each mode (Feeding Approved Job).</b> Functions without a checkmark cannot be used for printing using that tray. → System Settings > "Paper Tray Settings" > "Tray Settings" > "Change" > <input checked="" type="checkbox"/> (Each mode)
<b>The image on paper is skewed.</b>	Is too much paper loaded in the bypass tray?	<b>Do not load more than the maximum number of sheets.</b> The maximum number of sheets varies depending on the paper type setting. For more information, see "SPECIFICATIONS" in the Start Guide.
	Are the bypass tray guides adjusted to the width of the paper?	<b>Adjust the bypass tray guides to the width of the paper.</b>
	Are the original guides adjusted to the width of the paper?	<b>Adjust the original guides to the width of the paper.</b>
<b>The automatic document feeder does not operate.</b>	Have functions been disabled by the administrator?	<b>Check with your administrator.</b> Some functions may have been disabled in the system settings (administrator).

# PROBLEMS RELATED TO QUALITY / PRINT RESULTS

Problem	Point to check	Solution
Lines appear in the scanned image.	Are the scanning areas of the document glass or automatic document feeder dirty?	<b>Clean the scanning areas of the document glass or automatic document feeder.</b>  1. BEFORE USING THE MACHINE "MAINTENANCE" (page 1-52)
	Is the bypass feed roller dirty?	<b>Clean the surface of the bypass feed roller.</b>  1. BEFORE USING THE MACHINE "MAINTENANCE" (page 1-52)
Smudges appear on printed output.	Are you using paper that is not within the specifications?	<b>Use SHARP-recommended paper.</b> Using paper that is for other models or special paper that is not supported may result in misfeeds, creases, or smudges.  "SUPPLIES" in the Start Guide
	Are you printing on pre-punched paper?	<b>Take care that the image does not overlap the punch holes.</b> If the printed image overlaps the punch holes, smudges may appear on the reverse side of the paper following one-sided printing, or on both sides following two-sided printing.
	Does a message appear indicating the need for maintenance?	<b>Contact your dealer or nearest authorised service representative as soon as possible.</b>
Toner does not adhere well or creases appear in the paper.	Are you using paper that is not within the specifications?	<b>Use SHARP-recommended paper.</b> Using paper that is for other models or special paper that is not supported may result in misfeeds, creases, or smudges.  "SUPPLIES" in the Start Guide
	Did you set the correct paper type?	<b>Set the correct paper type in the tray settings.</b> Make sure that the following has not occurred: <ul style="list-style-type: none"> <li>• Heavy paper is being used, but a paper type other than heavy paper is selected in the tray settings. (The image may disappear if rubbed.)</li> <li>• Paper other than heavy paper is being used, but heavy paper is selected in the tray settings. (This may cause creases and misfeeds.)</li> </ul> → System Settings > "Paper Tray Settings" > "Tray Settings"
	Is the paper loaded so that printing takes place on the reverse side?	<b>Check that the paper is loaded so that printing takes place on the correct side.</b> If printing takes place on the wrong side of label sheets or transparency film, the toner may not adhere well and a clear image may not be obtained.
Print quality is poor.	Is "Toner Save Mode" enabled?	<b>Check with your administrator.</b> When "Toner Save Mode" is enabled, printing takes place using less toner and thus the print result is lighter.

Problem	Point to check	Solution
Part of the image is cut off.	Has the correct paper size been set?	<p><b>If you are using a special size, be sure to specify the paper size.</b></p> <p>If the size of paper loaded in a tray was changed, be sure to check the paper size setting.</p> <p>→ System Settings &gt; "Paper Tray Settings" &gt; "Tray Settings"</p>
	Was the original placed in the correct position?	<p><b>If you are using the document glass, be sure to place the original in the far left corner of the document glass.</b></p> <p>☞ 1. BEFORE USING THE MACHINE "PLACING THE ORIGINAL ON THE DOCUMENT GLASS" (page 1-40)</p>
Printing takes place on the wrong side of the paper.	Is the paper loaded with the print side facing in the correct direction?	<p><b>Check that the paper is loaded so that printing takes place on the correct side.</b></p> <ul style="list-style-type: none"> <li>• Trays 1 to 4: Load the paper with the front side facing up*.</li> <li>• Bypass tray and tray 5: Load the paper with the front side facing up*.</li> </ul> <p>* When the paper type is "Pre-Printed" or "Letter Head", load the paper in the opposite way. (Except when "Disabling of Duplex" is enabled in the system settings (administrator). For the current setting, check with your administrator.)</p>
A cover or insert is not printed on the specified paper.	Has the paper type been set correctly?	<p><b>Set the correct paper type for the tray that contains the paper specified for the cover or insert.</b></p> <p>If the paper type set for the cover or insert is not the same as the paper type set for the tray, paper will be fed from a different tray.</p> <p>→ System Settings &gt; "Paper Tray Settings" &gt; "Tray Settings"</p>





# PROBLEMS RELATED TO PERIPHERAL DEVICES

Problem	Point to check	Solution
<b>The connected USB device cannot be used.</b>	Is the USB device compatible with the machine?	<b>Ask your dealer if the device is compatible with the machine.</b>
	Is the connected USB device recognized correctly?	<b>Use "USB-Device Check" in the system settings to check whether or not the device can be recognized.</b> → System Settings > "USB-Device Check" If it is not recognized, connect it once again.
<b>The connected USB memory cannot be used.</b>	Is the format of the USB memory FAT32?	<b>Check the USB memory device format.</b> If the format of the USB memory is other than FAT32, use your computer to change the format to FAT32.
	Are you using a USB memory with a capacity of more than 32 GB?	<b>Use a 32 GB or less USB memory.</b>
<b>The finisher does not operate.</b>	Does a message appear indicating that you need to remove paper from the stapler compiler?	<b>Remove all remaining paper from the stapler compiler.</b>
	Does the following message appear in the touch panel? "Call for service. Code:xx-xx* Finisher trouble." *Letters and numbers appear in xx-xx.	<b>Check the plug of the connecting cable of the finisher.</b> Plug and unplug the cable and after ensuring that it has been properly plugged, restart the power supply to the machine.
	Have functions been disabled by the administrator?	<b>Check with your administrator.</b> Some functions may have been disabled in the system settings (administrator).
<b>Stapling does not take place.</b>	Does a message appear instructing you to check the staple unit?	<b>Remove jammed staples.</b> 🔍 "REMOVING STAPLE JAMS" (page 8-11)
	Does a message appear instructing you to add staples?	<b>Replace the staple cartridge.</b> Do not forget to replace the staple case. 🔍 "REMOVING STAPLE JAMS" (page 8-11)
	Is a different width of paper mixed in?	<b>To perform mixed size stapling, use paper of the same width and select the [Same Width] setting.</b> Stapling is not possible when paper of different widths are mixed together. When copying, select [Same Width] from [Mixed Size Original] in the special modes.
	Are there more sheets than can be stapled at once?	<b>For the maximum number of sheets that can be stapled, see "SPECIFICATIONS" in the Start Guide.</b>
	Is a paper size that cannot be stapled included in the print job?	<b>For the paper sizes that can be stapled, see "SPECIFICATIONS" in the Start Guide.</b>

Problem	Point to check	Solution
<b>Stapling does not take place.</b>	Is the paper type setting of the tray selected in the printer driver set to a paper type that cannot be stapled?	Check the paper type settings in the machine and select a tray that has paper that can be used for stapling*. Click the [Tray Status] button in "Paper Selection" on the [Paper] tab of the printer properties window and check the paper type setting of each tray. * Stapling is not possible on labels, tab paper, transparency film, glossy paper or envelopes. In addition, if "Disable Staple" is selected in the user type, stapling will not be possible.
	Have functions been disabled by the administrator?	<b>Check with your administrator.</b> Some functions may have been disabled in the system settings (administrator).
<b>Punching does not take place.</b>	Does a message appear instructing you to check the punch module?	<b>Dispose of punch scraps.</b> ☞ 1. BEFORE USING THE MACHINE "PUNCH MODULE" (page 1-47)
	Is a different size of paper mixed in?	Punching is not possible when different widths of paper are mixed together. To perform mixed size punching, use paper of the same width and select the [Same Width] setting. When copying, select [Same Width] for [Mixed Size Original] in the special modes.
	Is a paper size that cannot be punched included in the print job?	<b>For the paper sizes that can be punched, see "SPECIFICATIONS" in the Start Guide.</b>
	Is the tray selected in the printer driver set to a paper type that cannot be punched?	Check the paper type settings in the machine and select a tray that has paper that can be used for punching*. Click the [Tray Status] button in "Paper Selection" on the [Paper] tab of the printer properties window and check the paper type setting of each tray. * Punching is not possible on labels, tab paper, transparency film, glossy paper and envelopes. In addition, if "Disable Punch" is selected in the user type, punching will not be possible.
	Have functions been disabled by the administrator?	<b>Check with your administrator.</b> Some functions may have been disabled in the system settings (administrator).
<b>The stapling position or punch position is not correct.</b>	Is the stapling position set correctly?	<b>Check the stapling position setting.</b> ☞ 2. COPIER "OUTPUT" (page 2-33)
	Are the punching positions set correctly?	<b>Check the punch position settings.</b> ☞ 2. COPIER "OUTPUT" (page 2-33)
<b>Sheets output to the delivery tray of the finisher are scattered.</b>	Have the output sheets got folded?	If the front and back side of the sheets in the paper feed tray have been reversed, in some cases it can be improved.
<b>The stapled sheets are scattered.</b>	Have the output sheets got folded?	If the front and back side of the sheets in the paper feed tray have been reversed, in some cases it can be improved.

## OTHER PROBLEMS

Problem	Point to check	Solution
Preview images or thumbnail images do not appear.	Are there a number of jobs waiting to be executed?	<b>Wait until several of the jobs have been executed.</b>
The touch panel screen is difficult to view.	Is the display contrast properly adjusted?	<p><b>Touch the brightness adjustment key (  ) on the system bar in the touch panel to adjust the brightness.</b></p> <p> 1. BEFORE USING THE MACHINE "SYSTEM BAR" (page 1-13)</p>
You were logged out without having performed logout yourself.	Did Auto Clear activate?	<p><b>Log in again.</b></p> <p>When user authentication is used, the currently logged in user will be automatically logged out if Auto Clear activates. (Except when in PC scan mode.)</p> <p>If you are the administrator, you can change the time setting of Auto Clear or disable Auto Clear in "Auto Clear Setting".</p> <p>→ System Settings (Administrator) &gt; "Operation Settings" &gt; "Other Settings" &gt; "Auto Clear Setting"</p>
You forgot the administrator password.	Was the administrator password changed from the factory default setting?	<p><b>Contact your dealer or nearest authorised service representative.</b></p> <p>For the factory default administrator password, see "TO THE ADMINISTRATOR OF THE MACHINE" in the Start Guide. After changing the password, take special care to remember it.</p>
You cannot save data in a folder for the NAS.	Amount of data in the folder has exceeded the upper limit.	<b>Delete some files to reduce the amount of data.</b>

# Operation Guide

MODEL: MX-2314N  
MX-2614N  
MX-3114N



# SHARP®

SHARP CORPORATION